

10-10

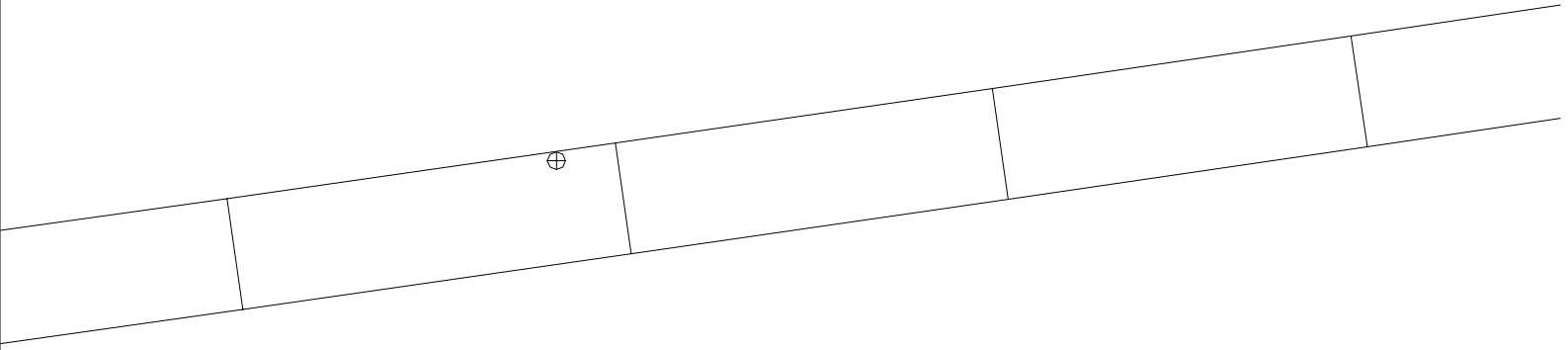

10-12

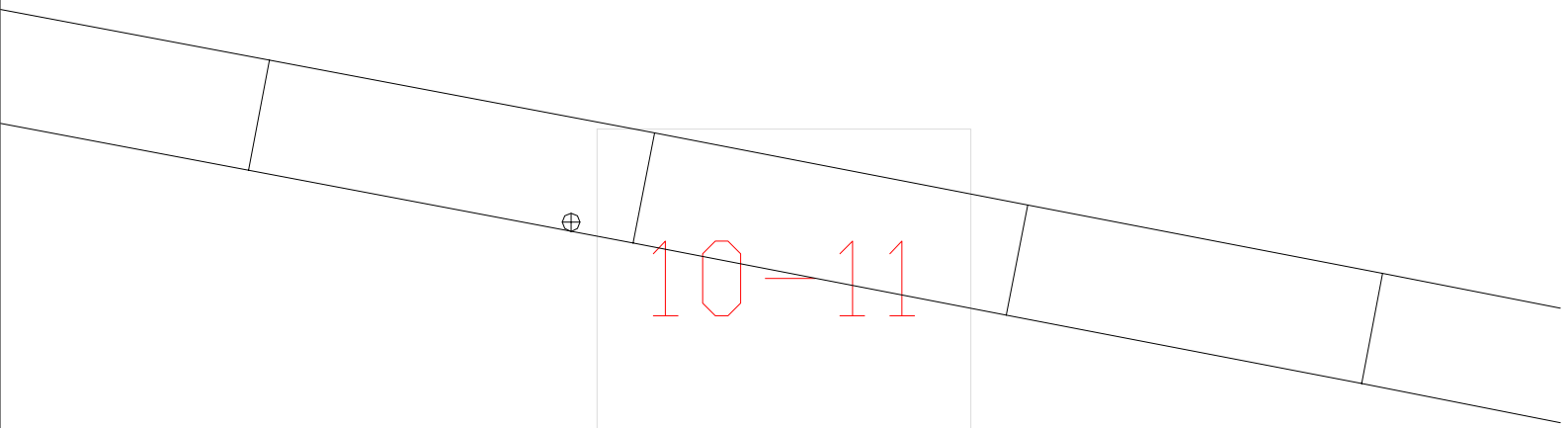
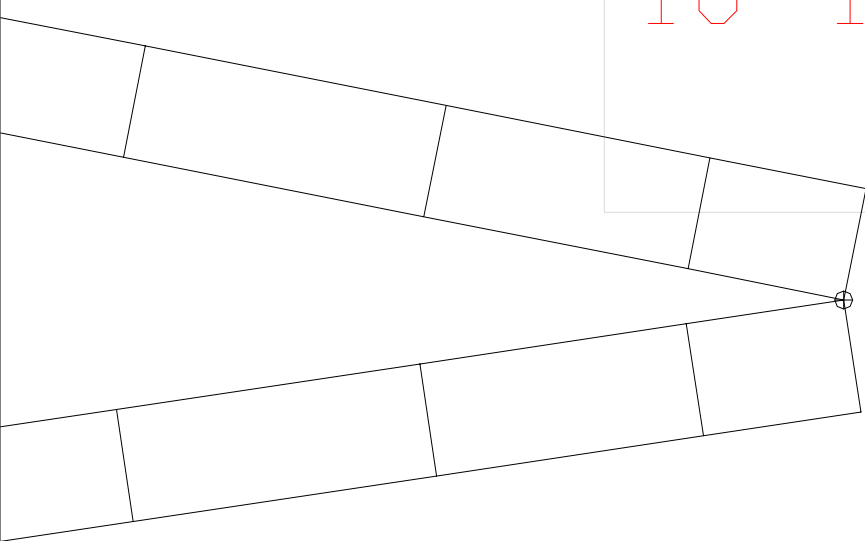

10-13

10-14

10-15

10-16



10-1

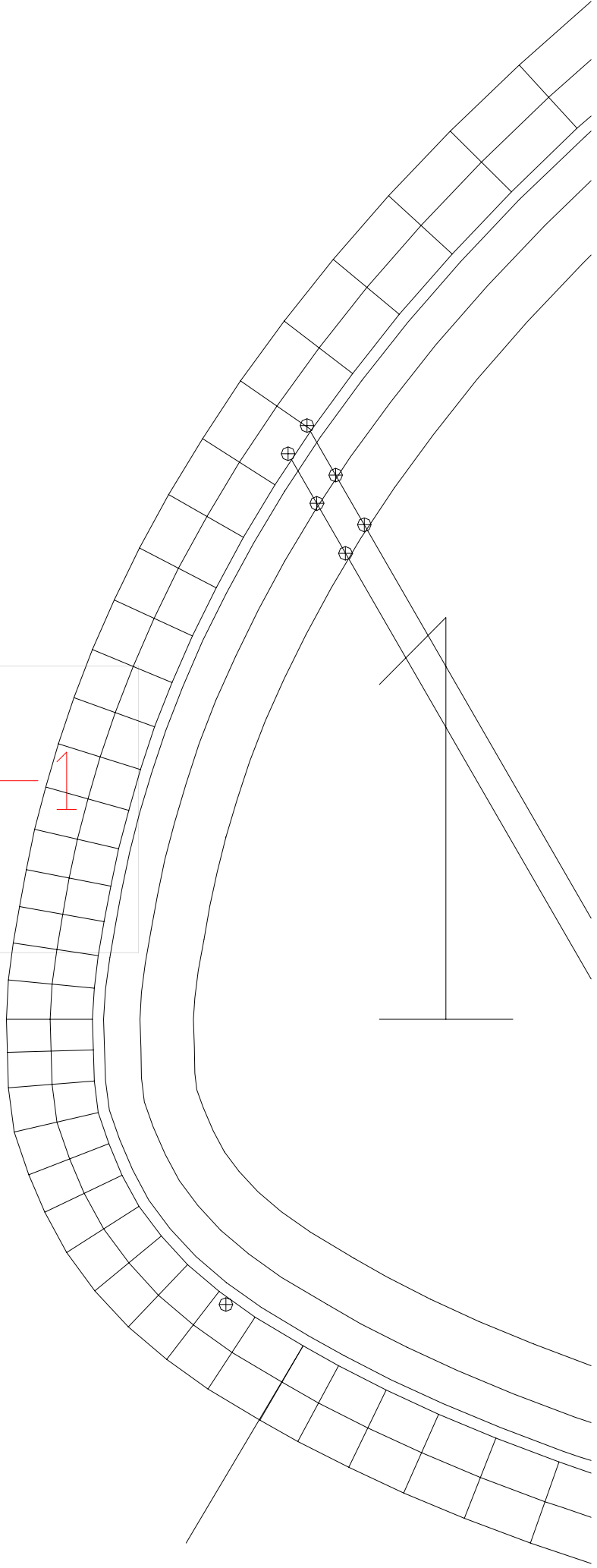

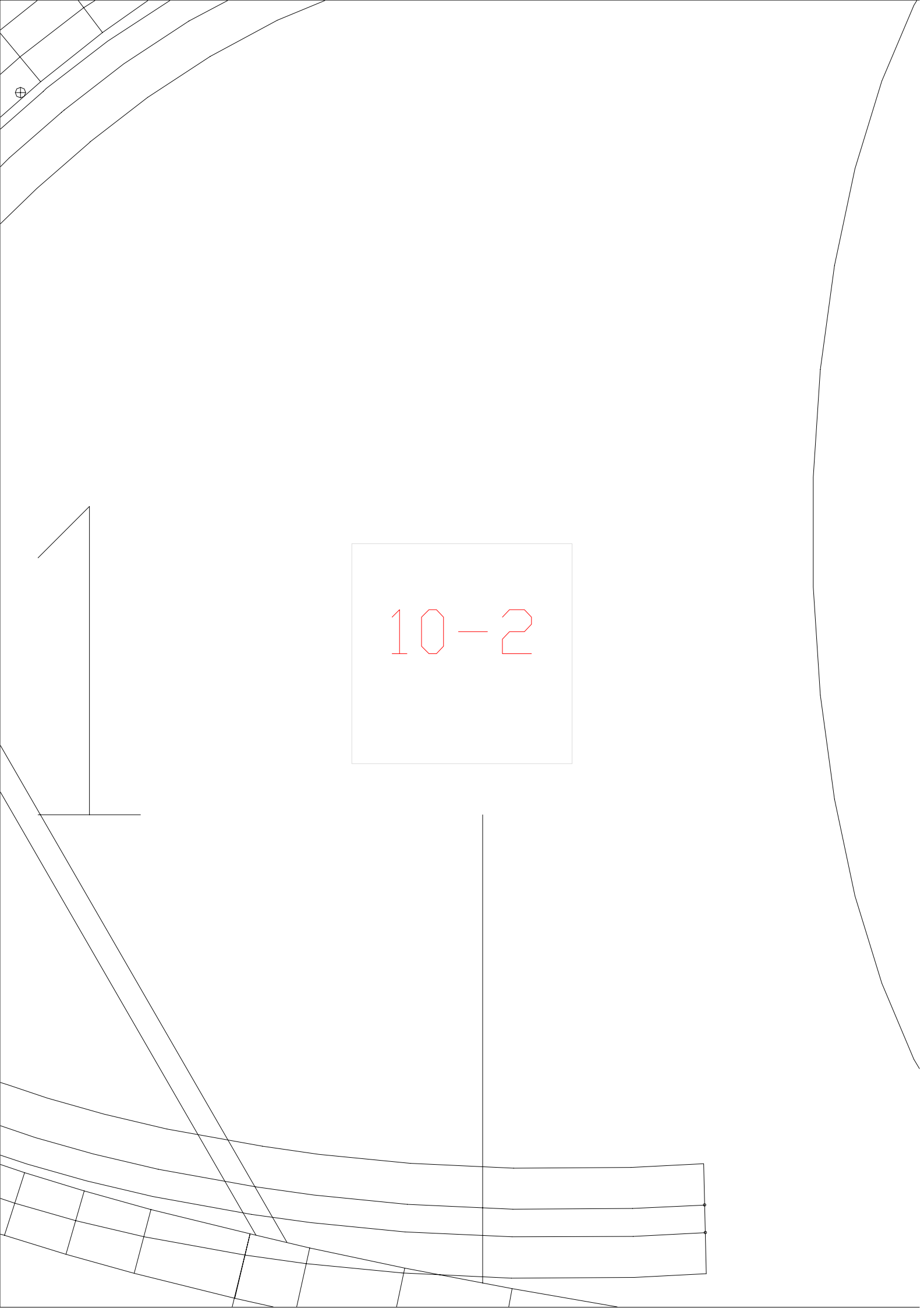

10-2

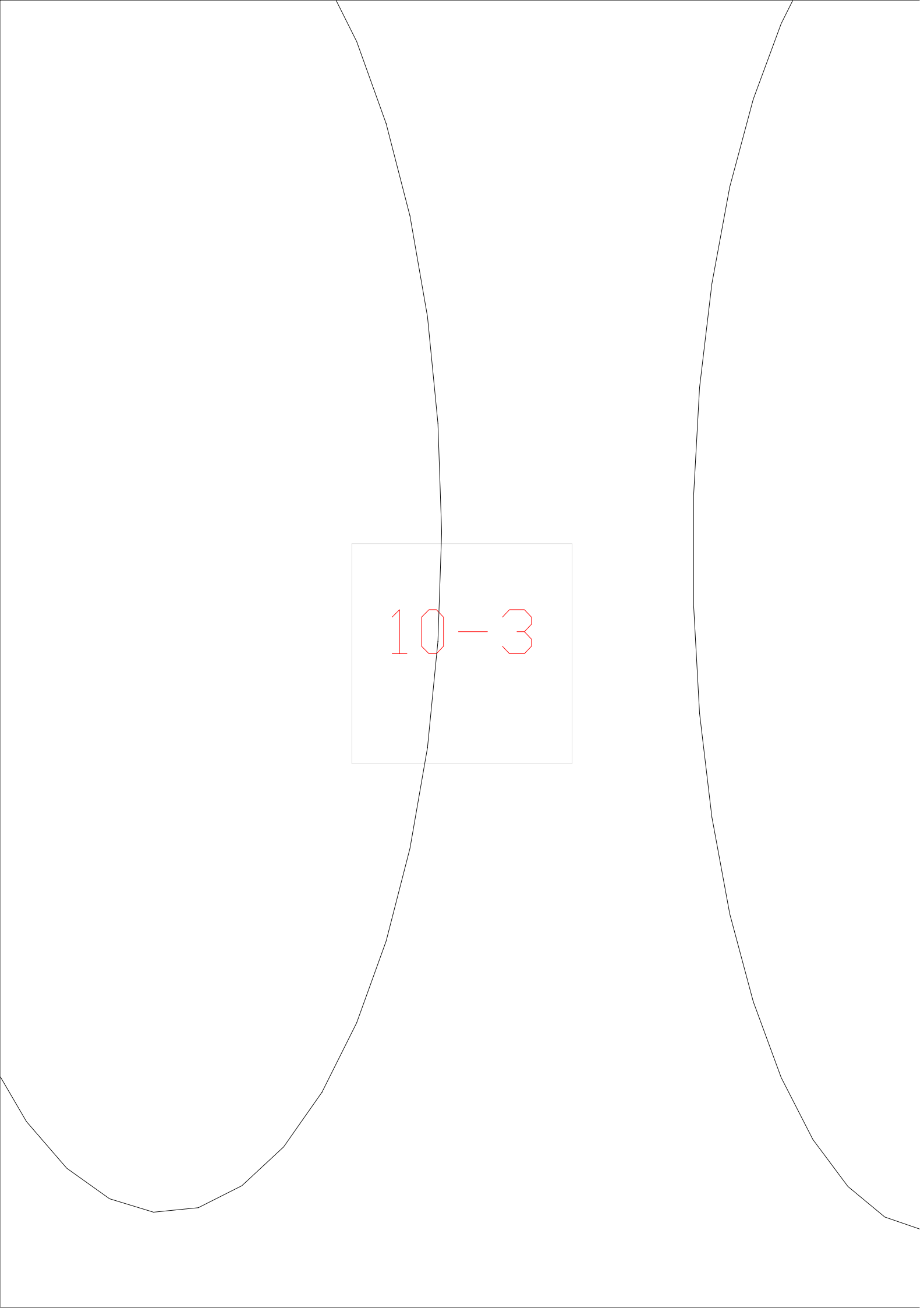
A diagram showing two intersecting curves. The curves are black lines on a white background. One curve starts at the top left, goes down to a minimum, and then goes up. The other curve starts at the top right, goes down to a minimum, and then goes up. The two curves intersect in the center. A light gray rectangular box is centered on the intersection, containing the text "10-3" in red.

10-3

10-4

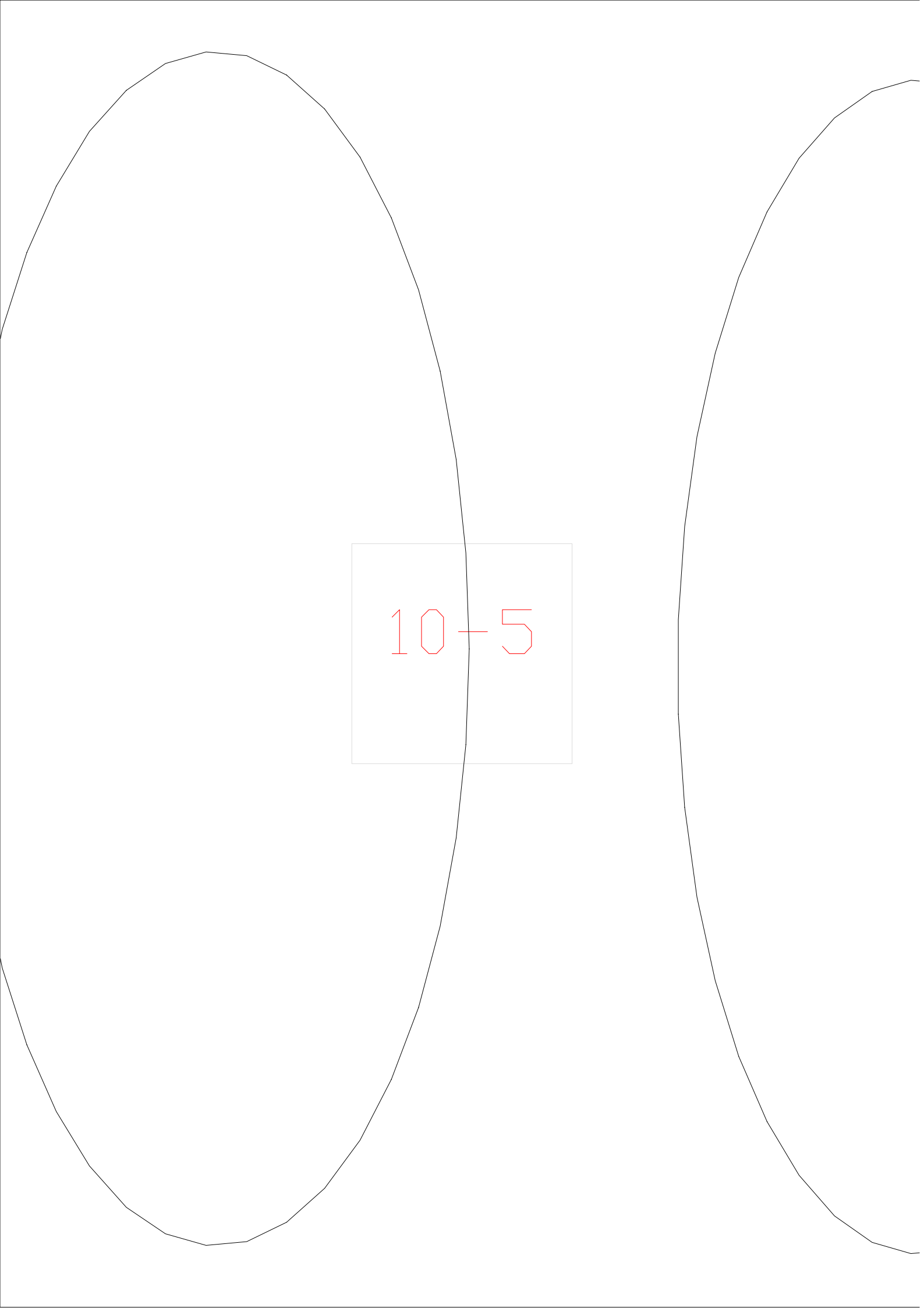

10-5

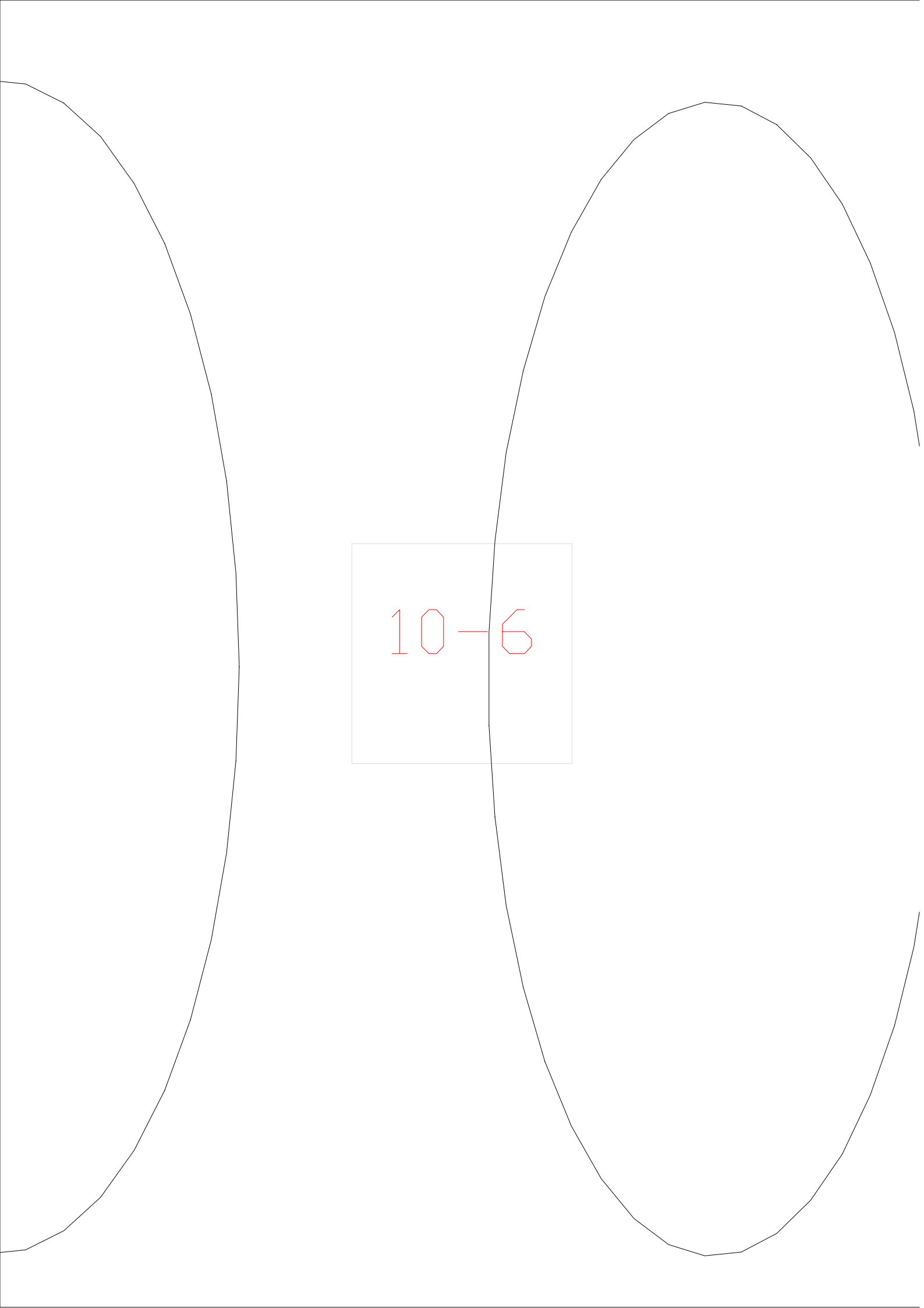

10-6

10-7

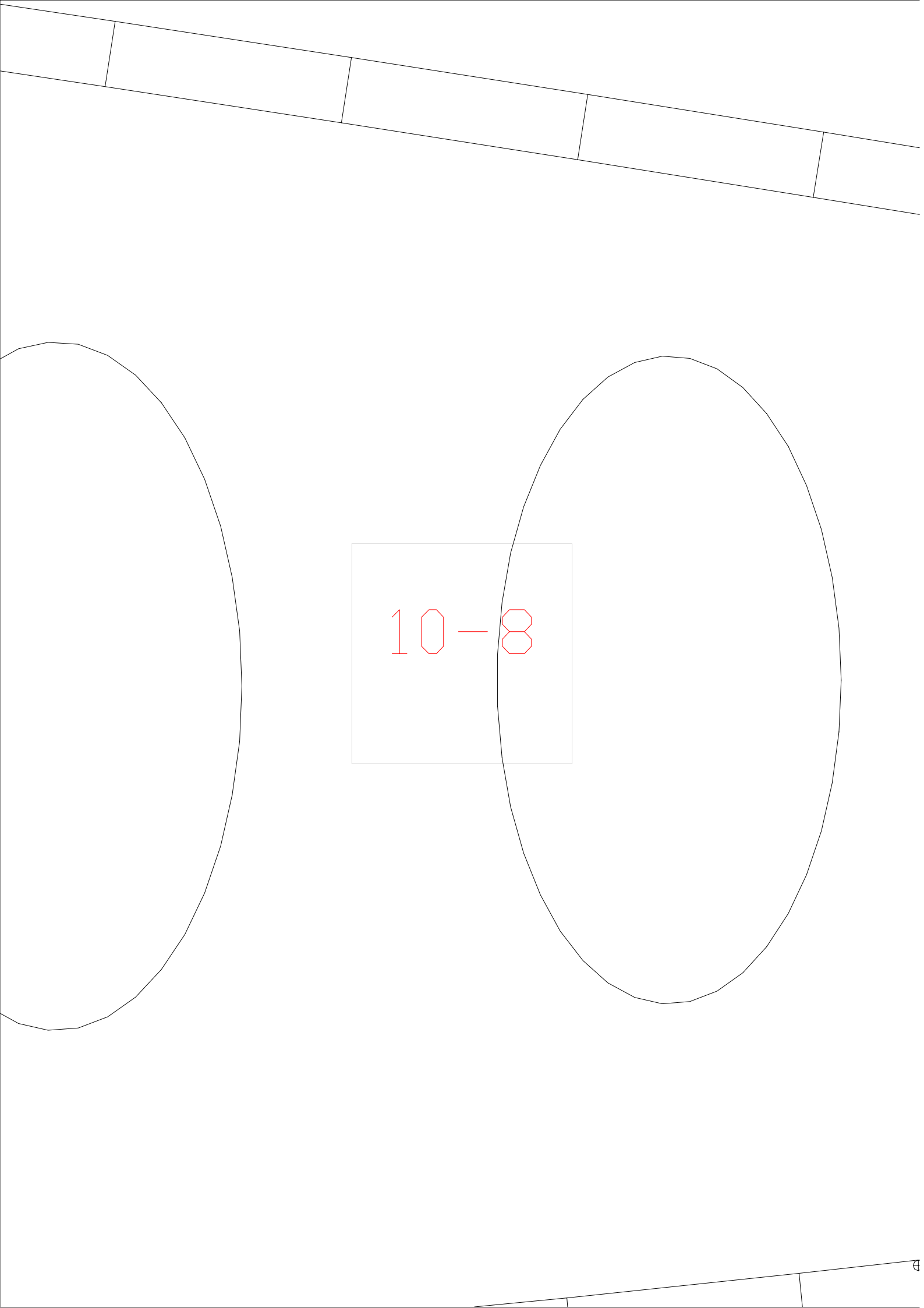

10-8



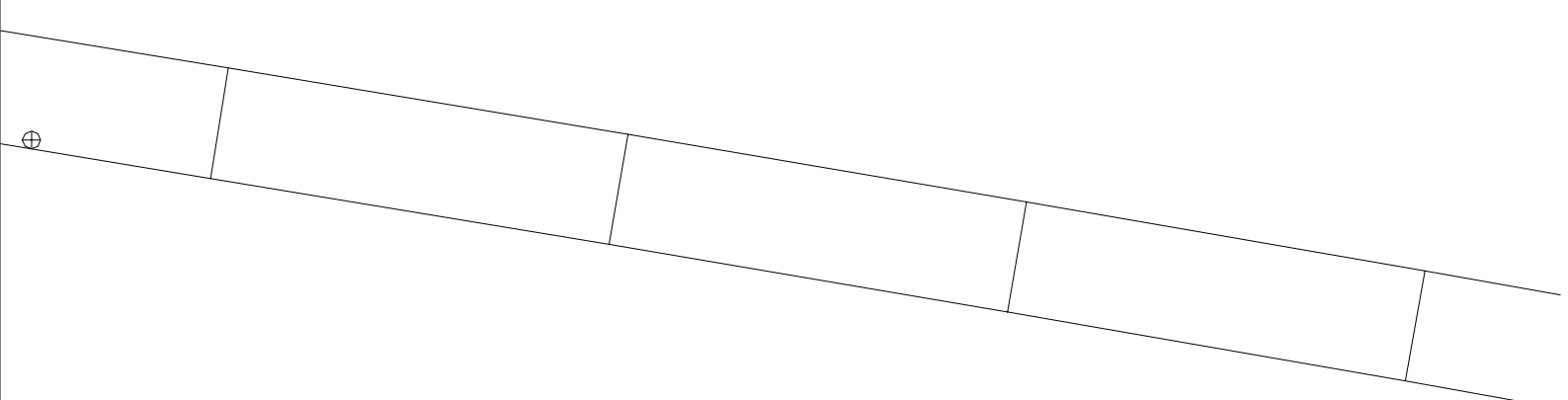

⊕

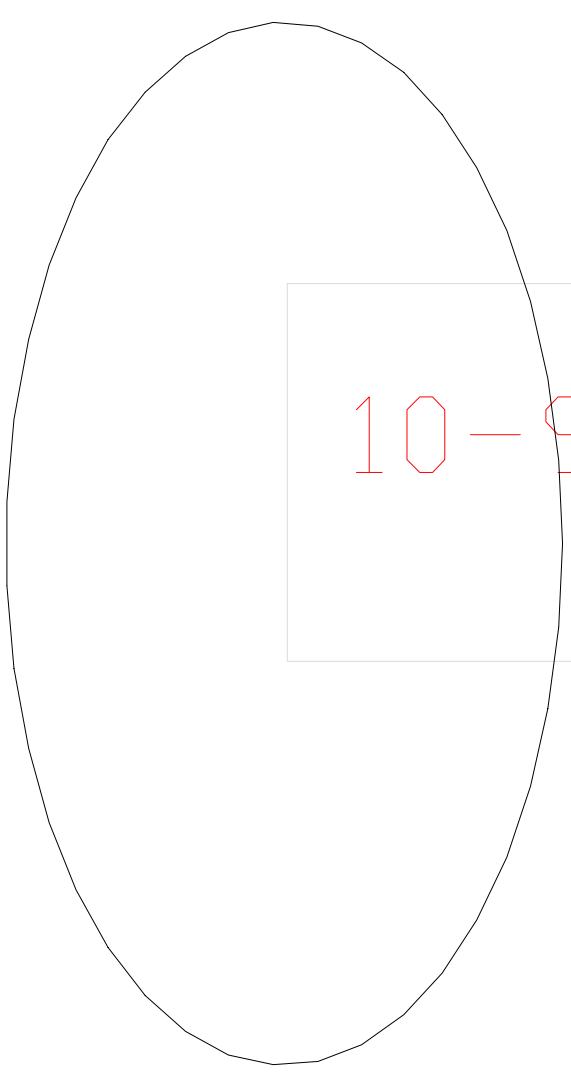

10-9

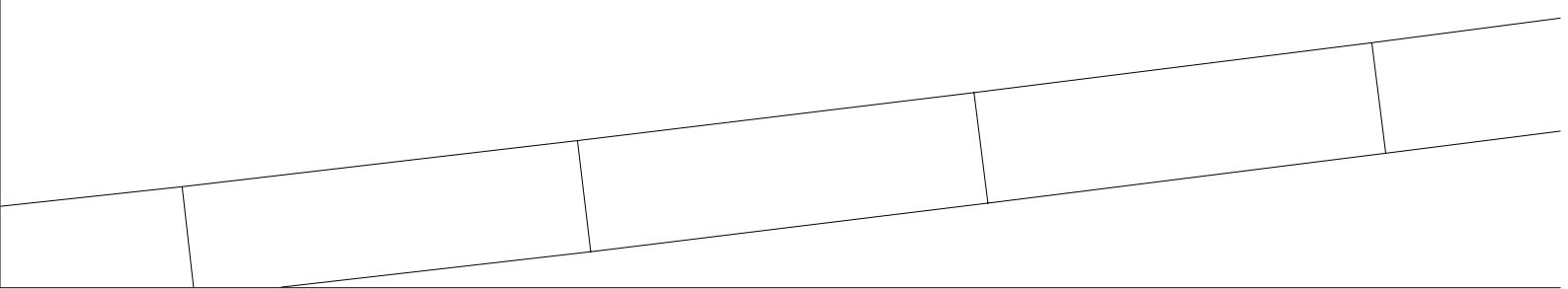

1-10

11-10



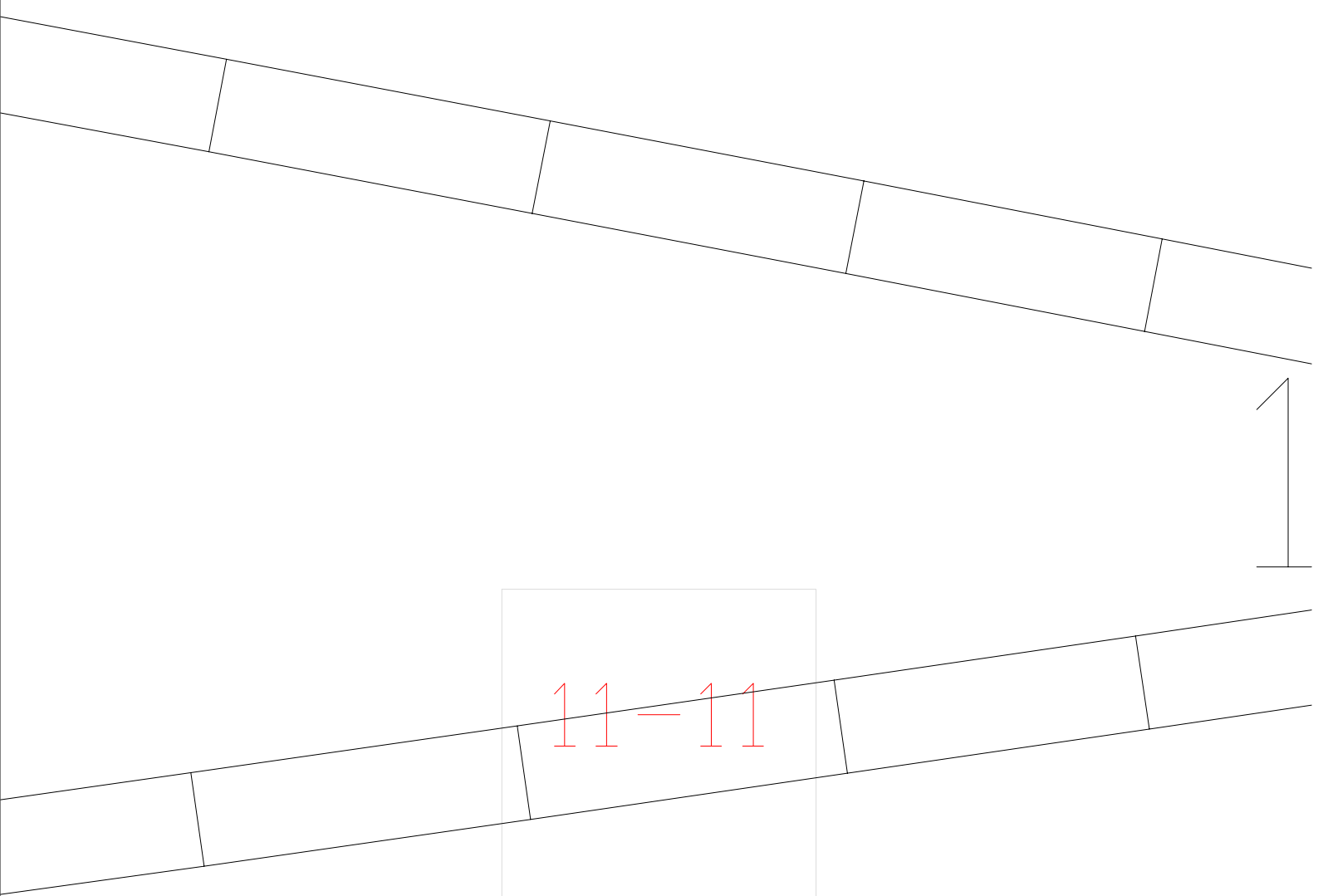

11-11

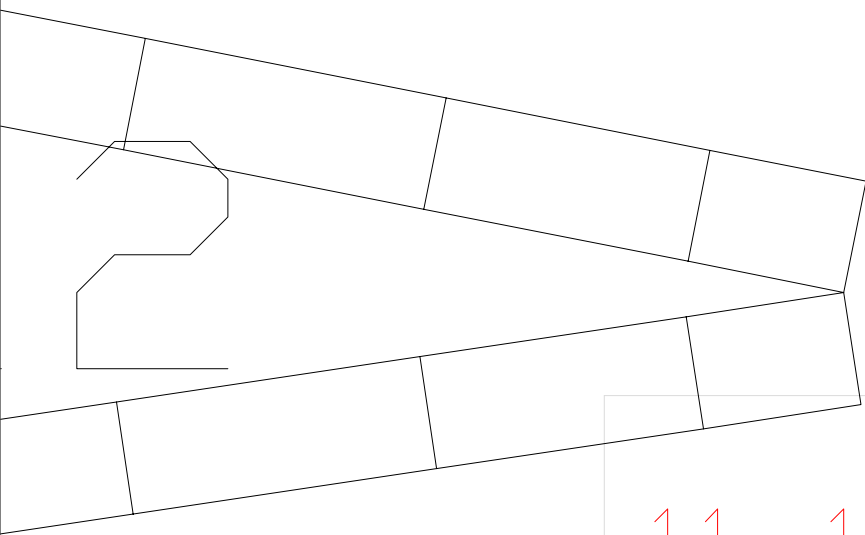

11-12

11-13

11-14

11-15



11-16

1 - 11

11-1

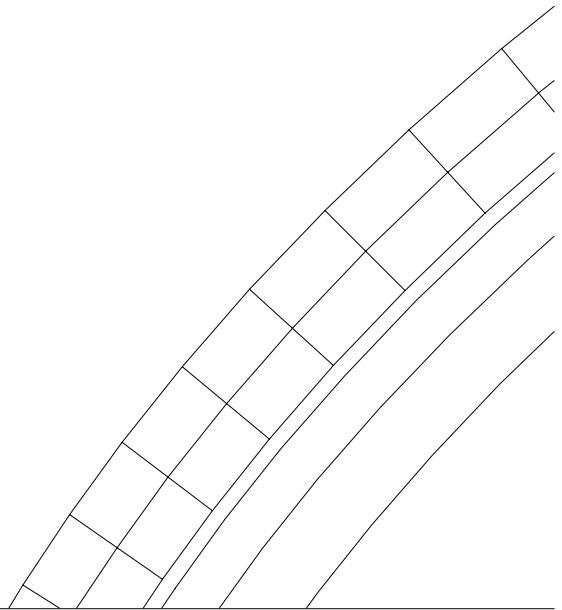

1-12

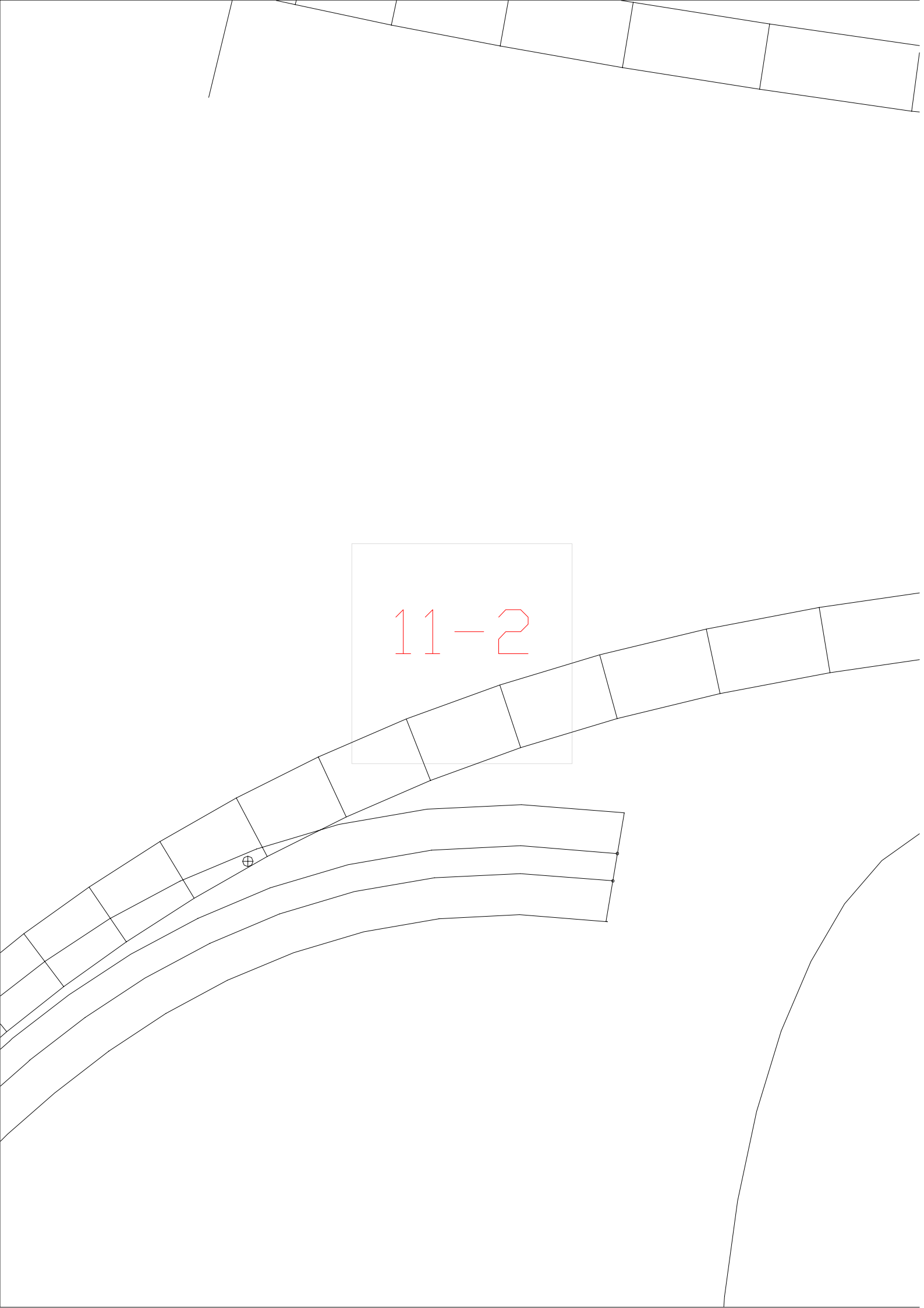

11-2

⊕

1-13

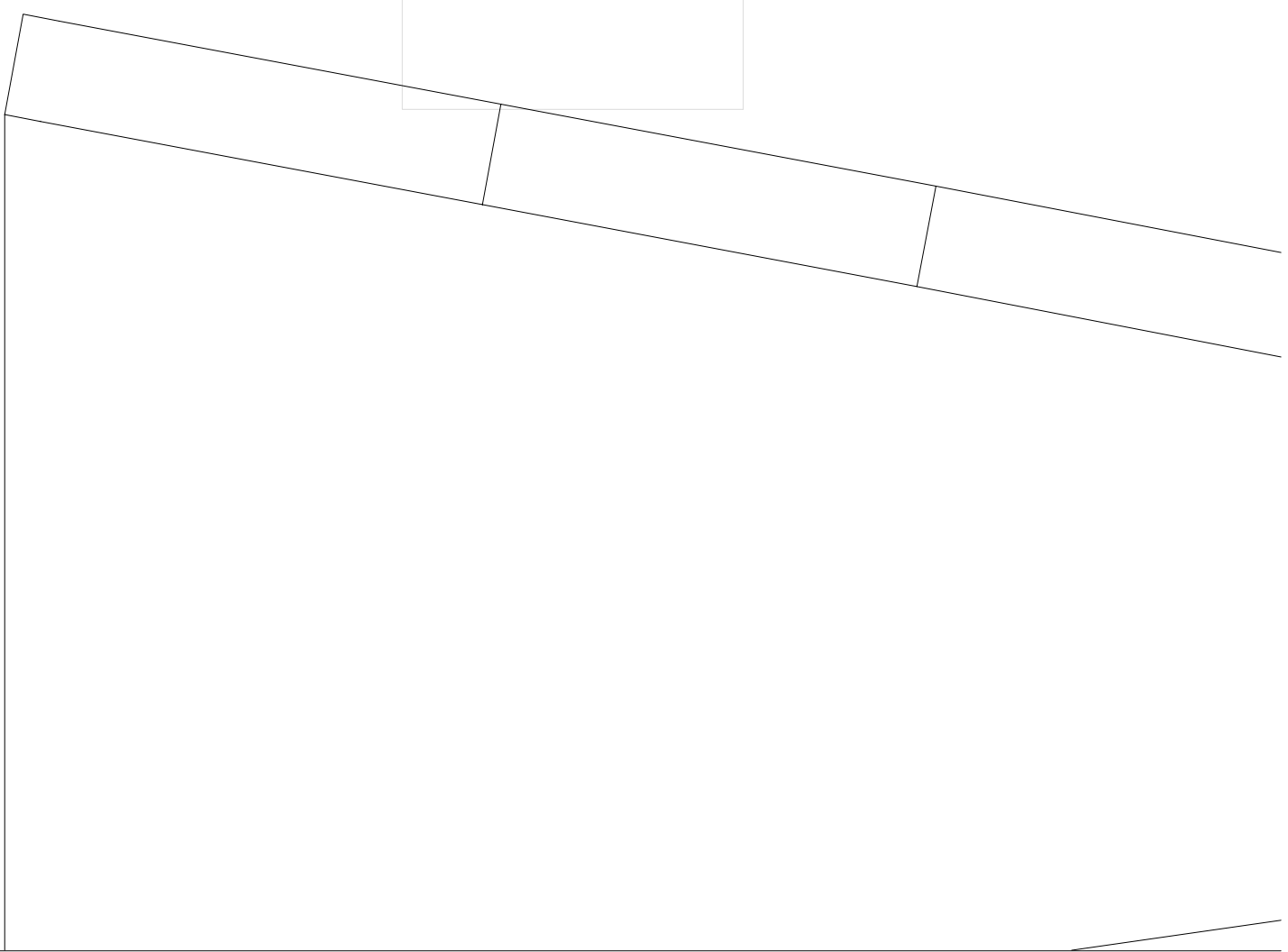

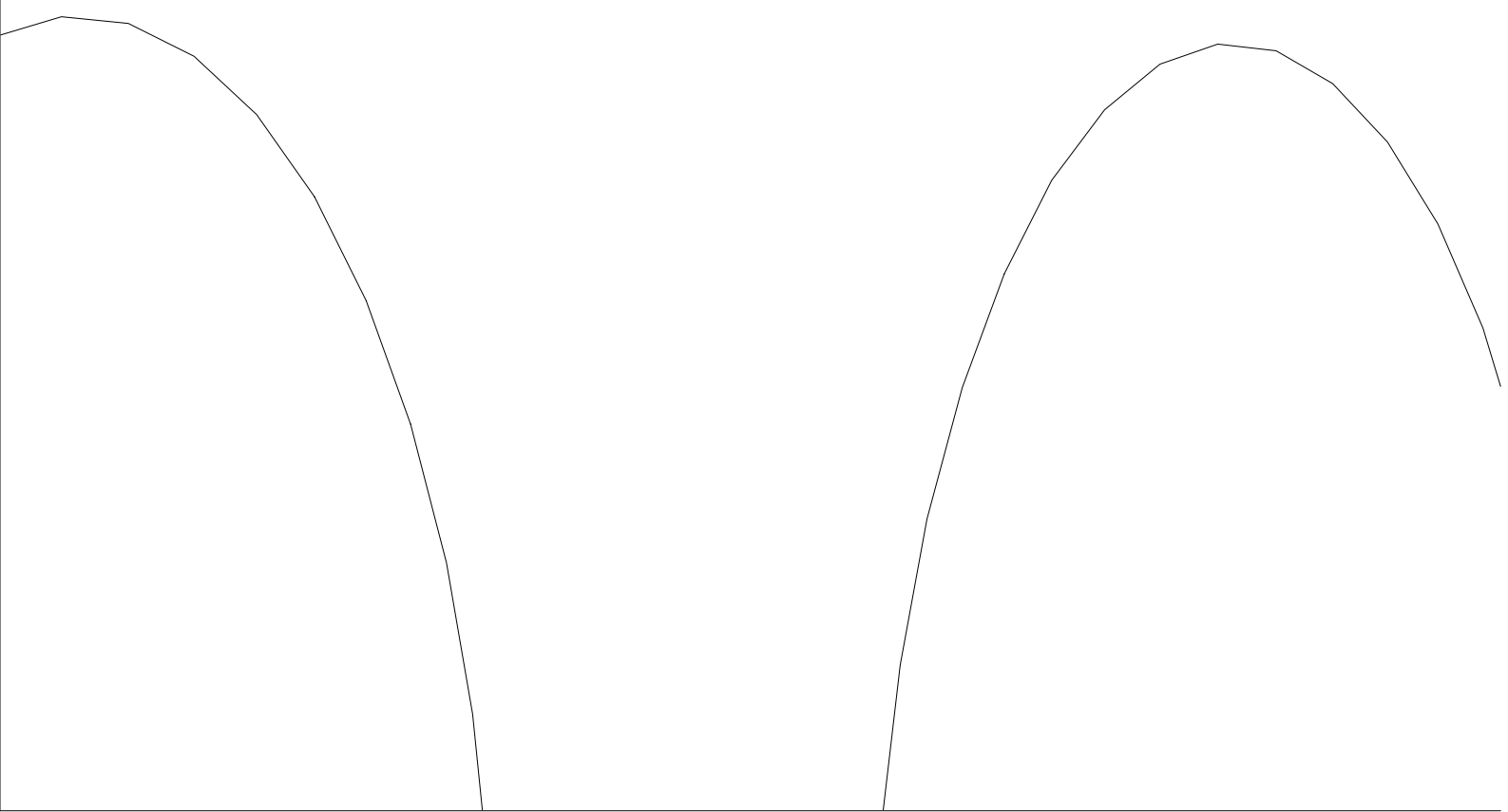
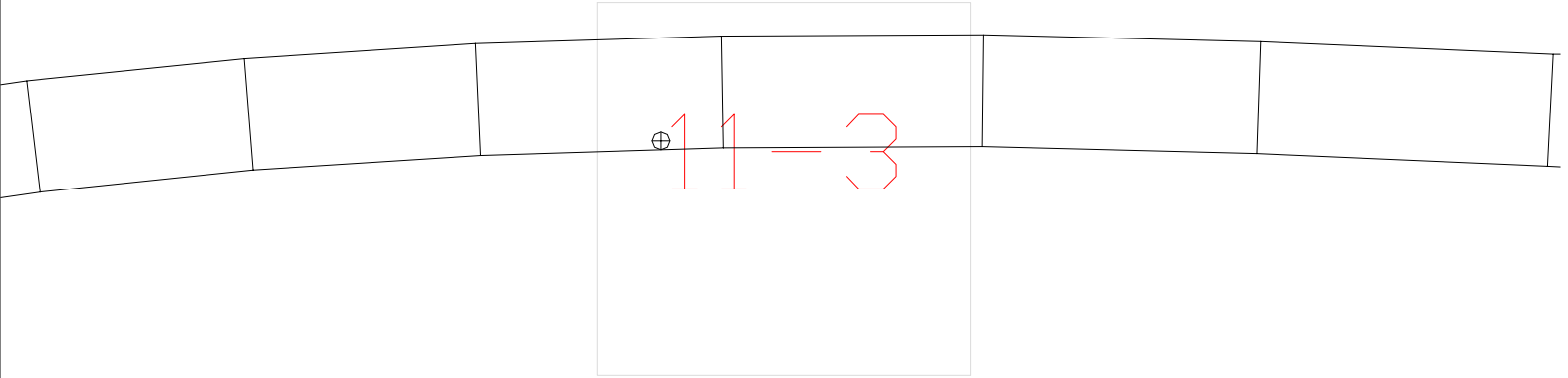
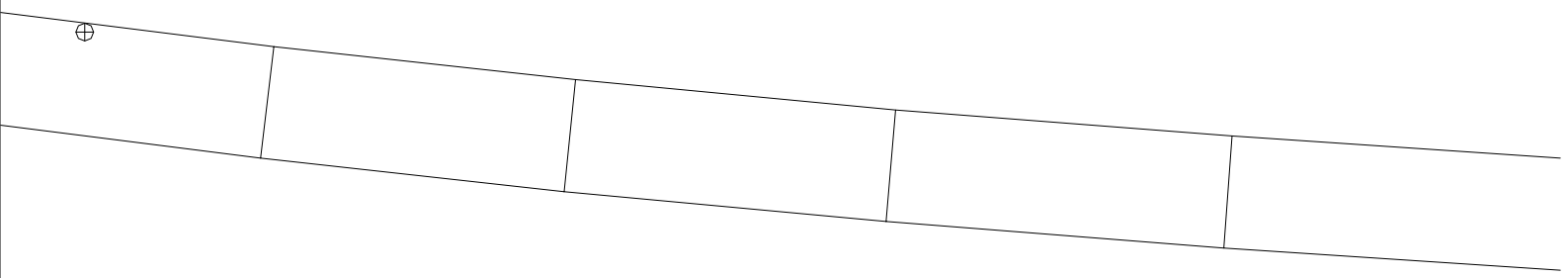

1-14

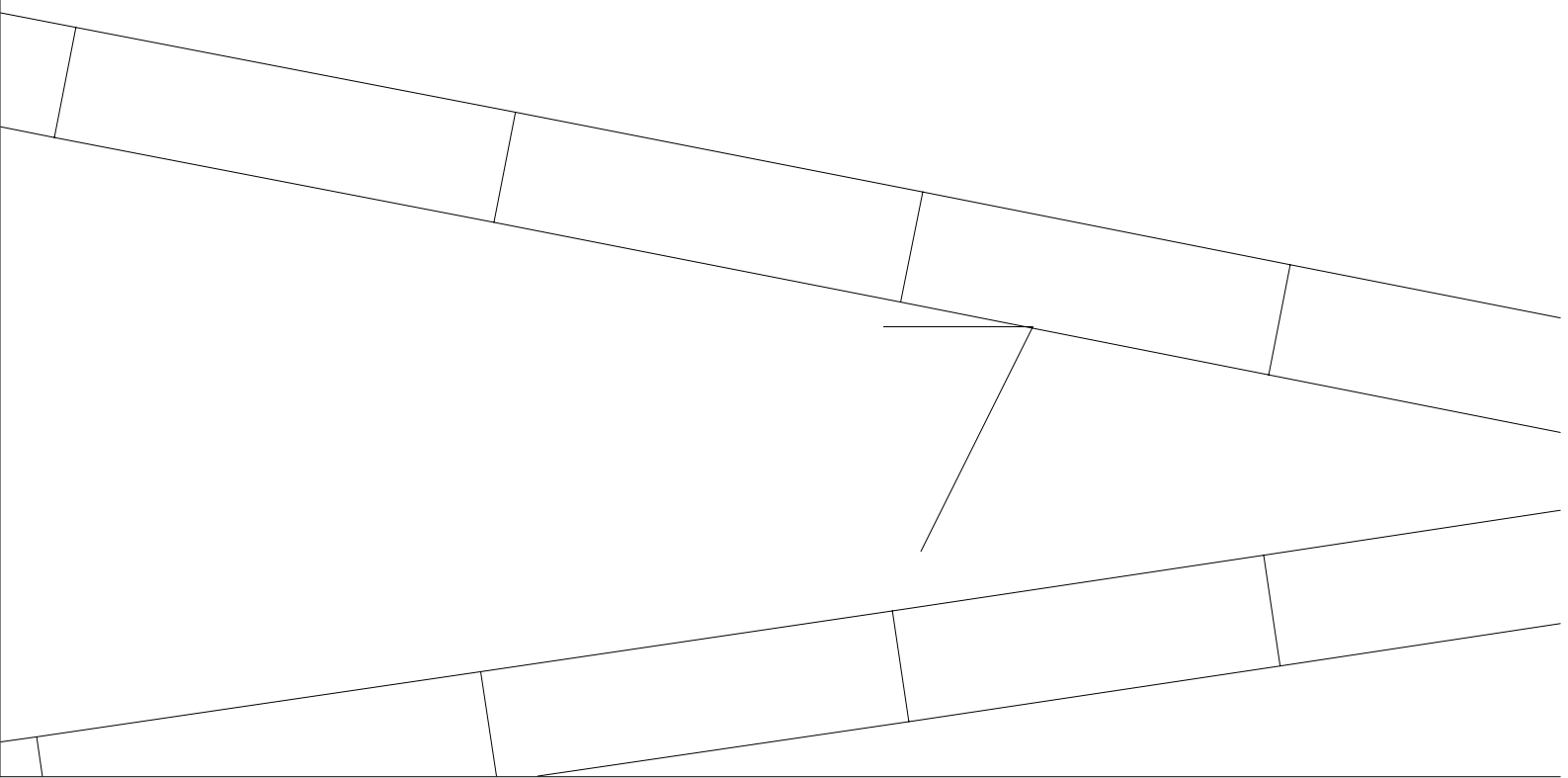





11-4

1-15

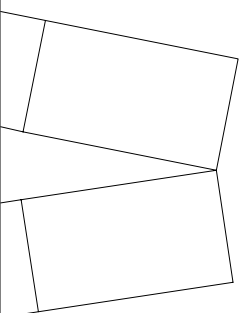

		⊕		
--	--	---	--	--

11-5

							⊕	
--	--	--	--	--	--	--	---	--

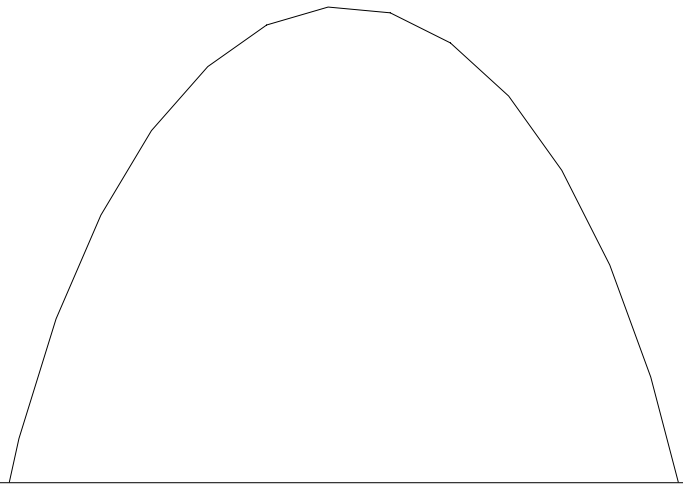
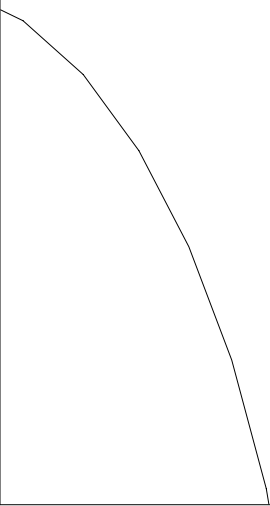

1-16

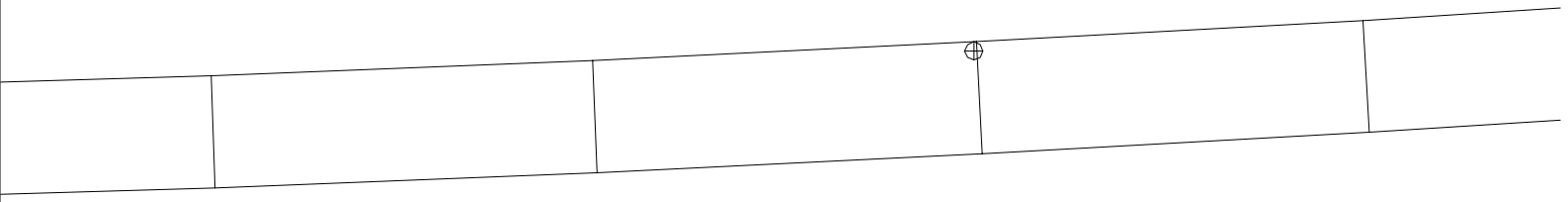

11-6

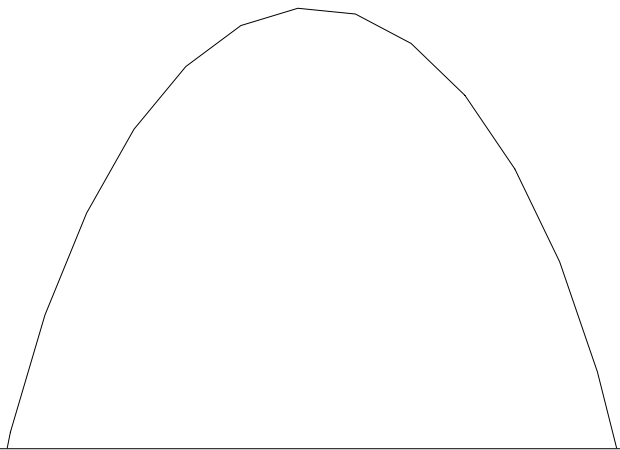
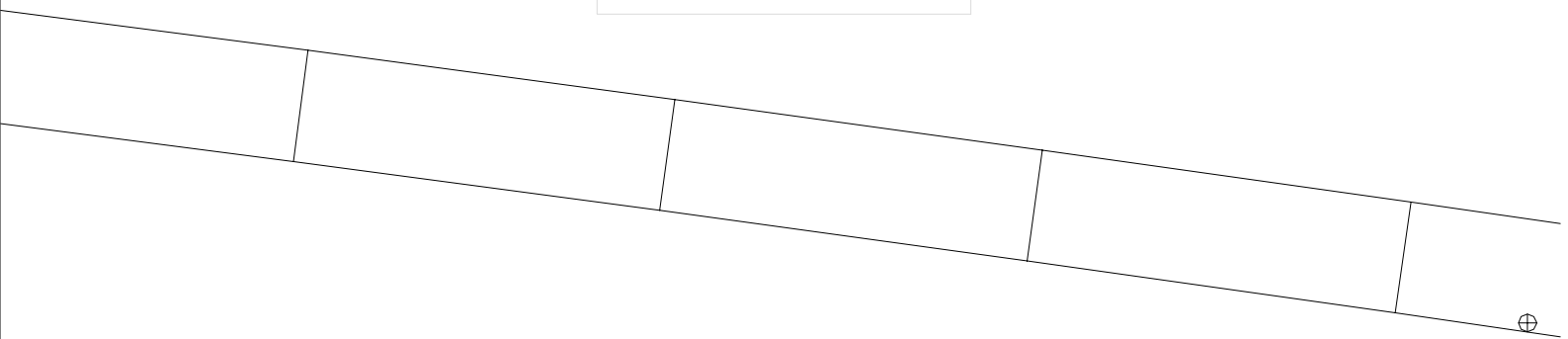

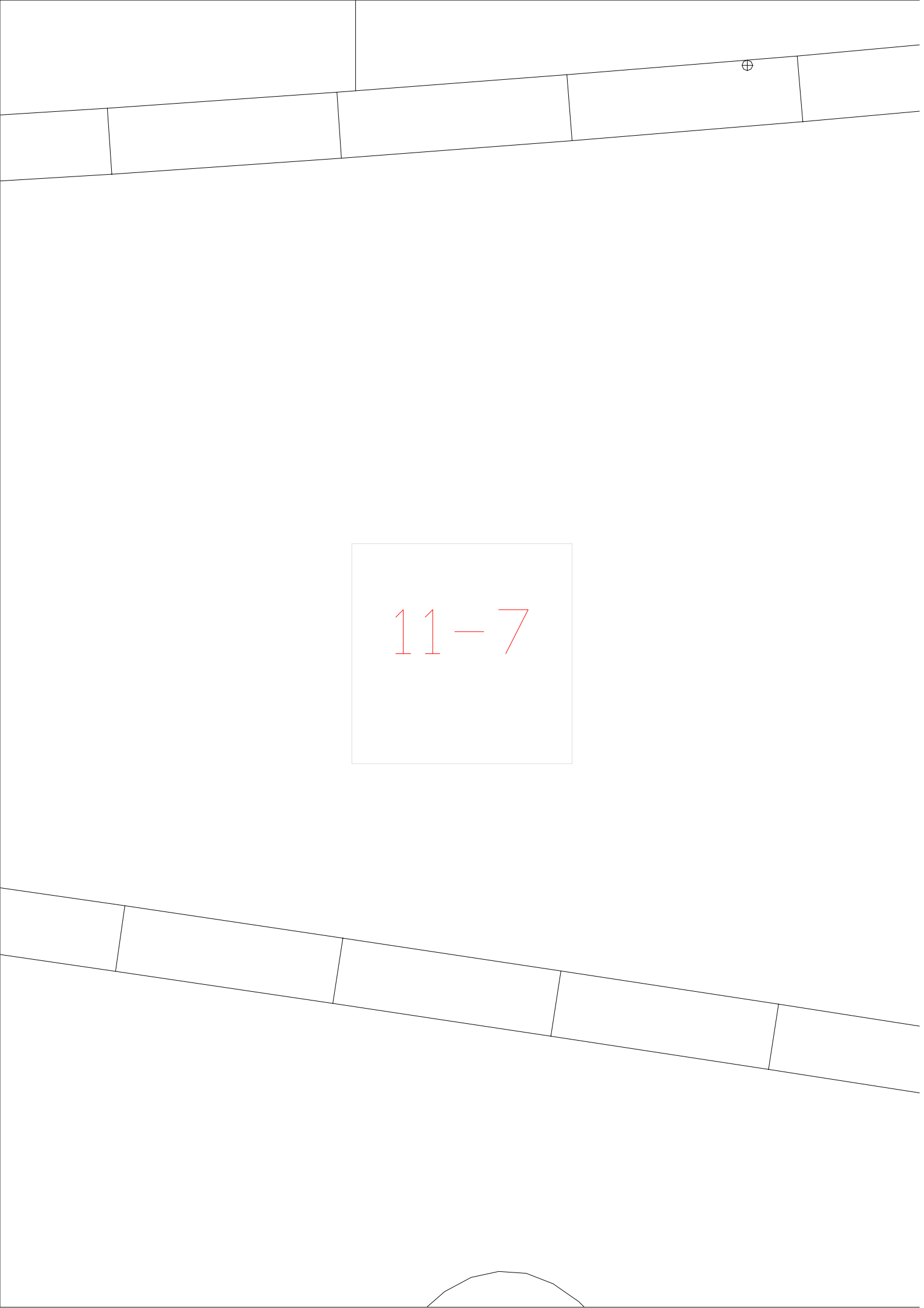

11-7

11-8

11-9



1 - 1

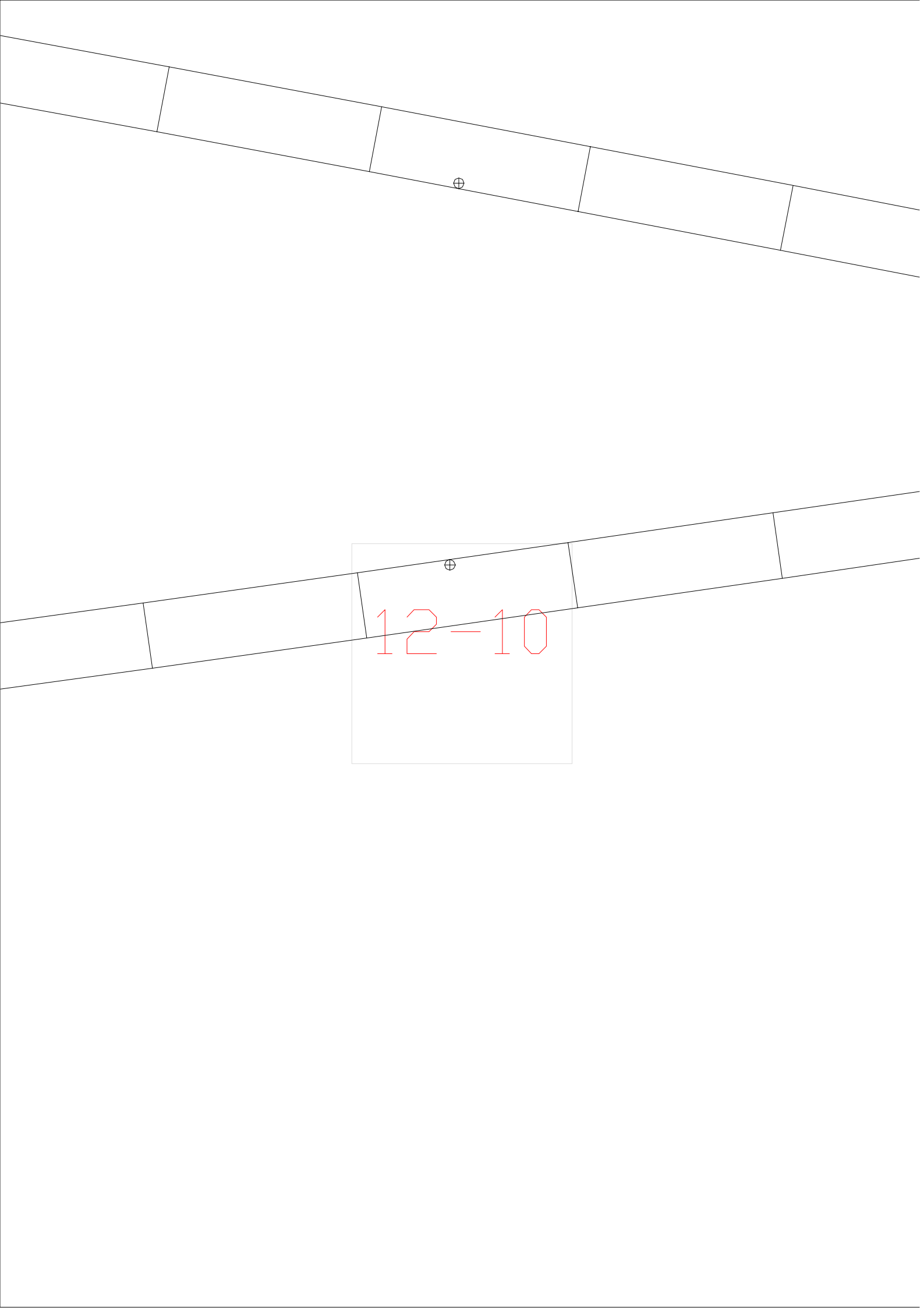

⊕

⊕

12-10

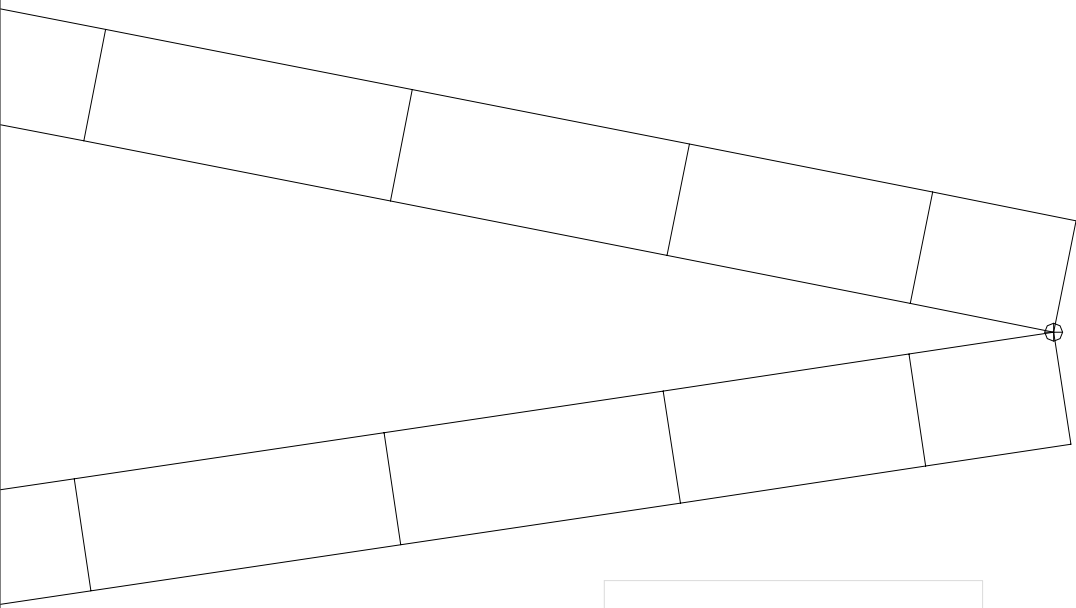

12-11

12-12

12-13

12-14

12-15

12-16



12-1

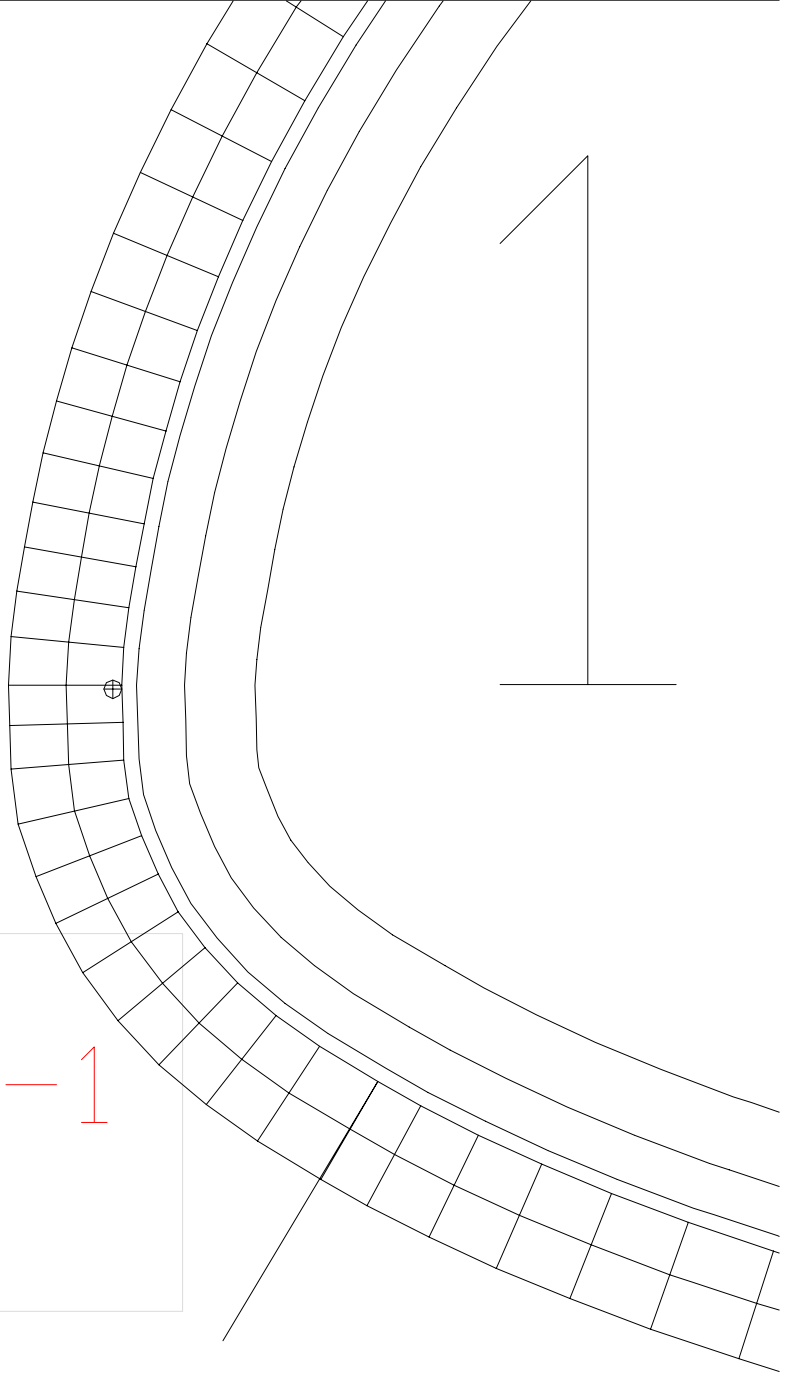

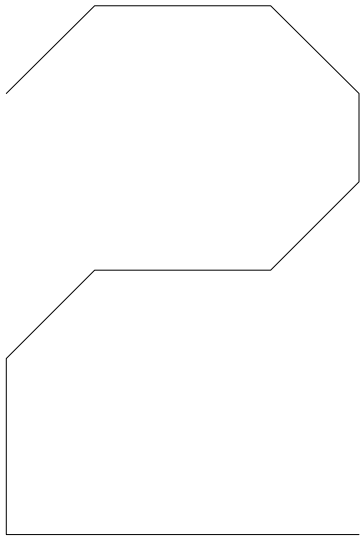

12-2

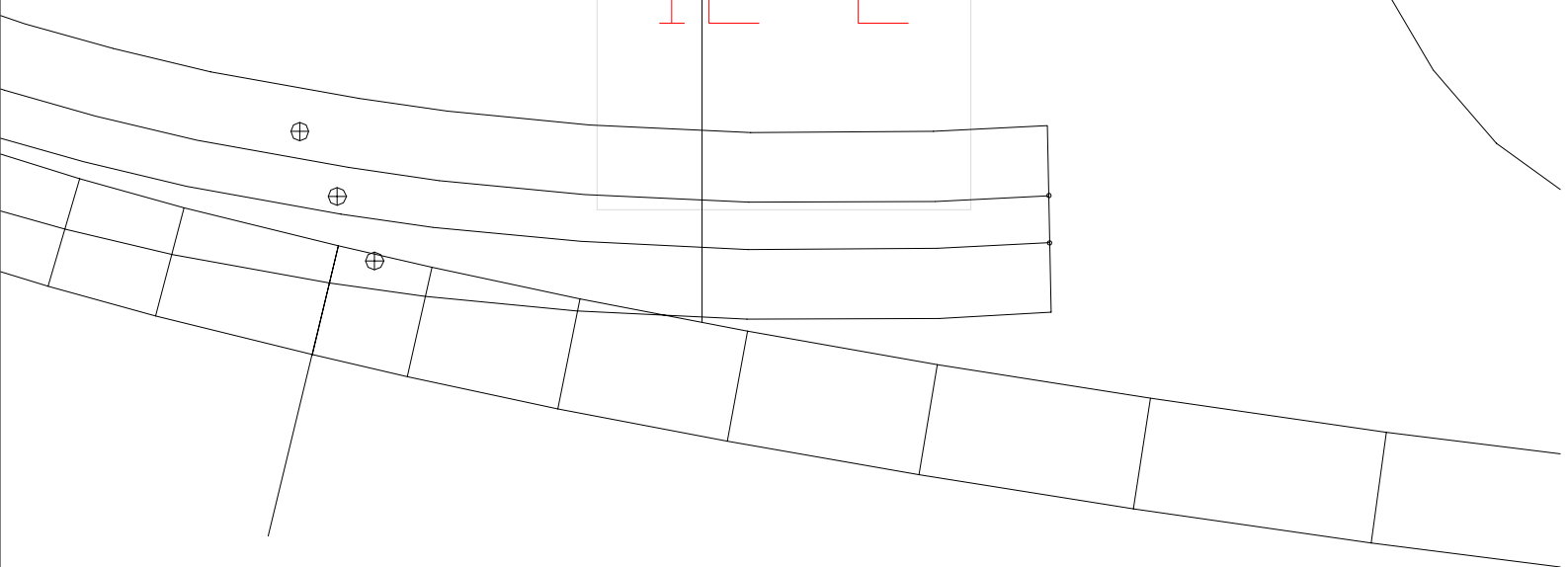

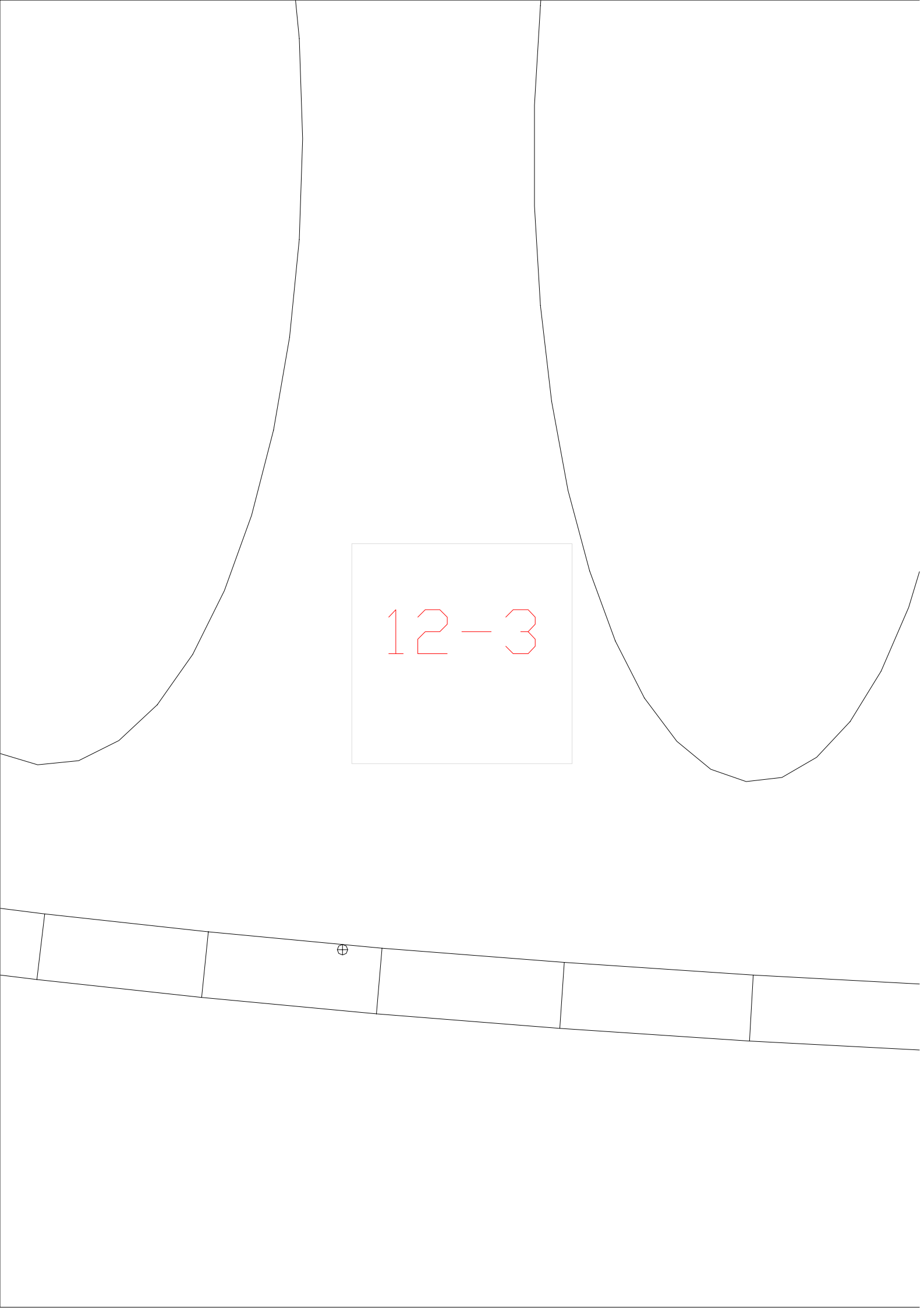

12-3

⊕

12-4

⊕

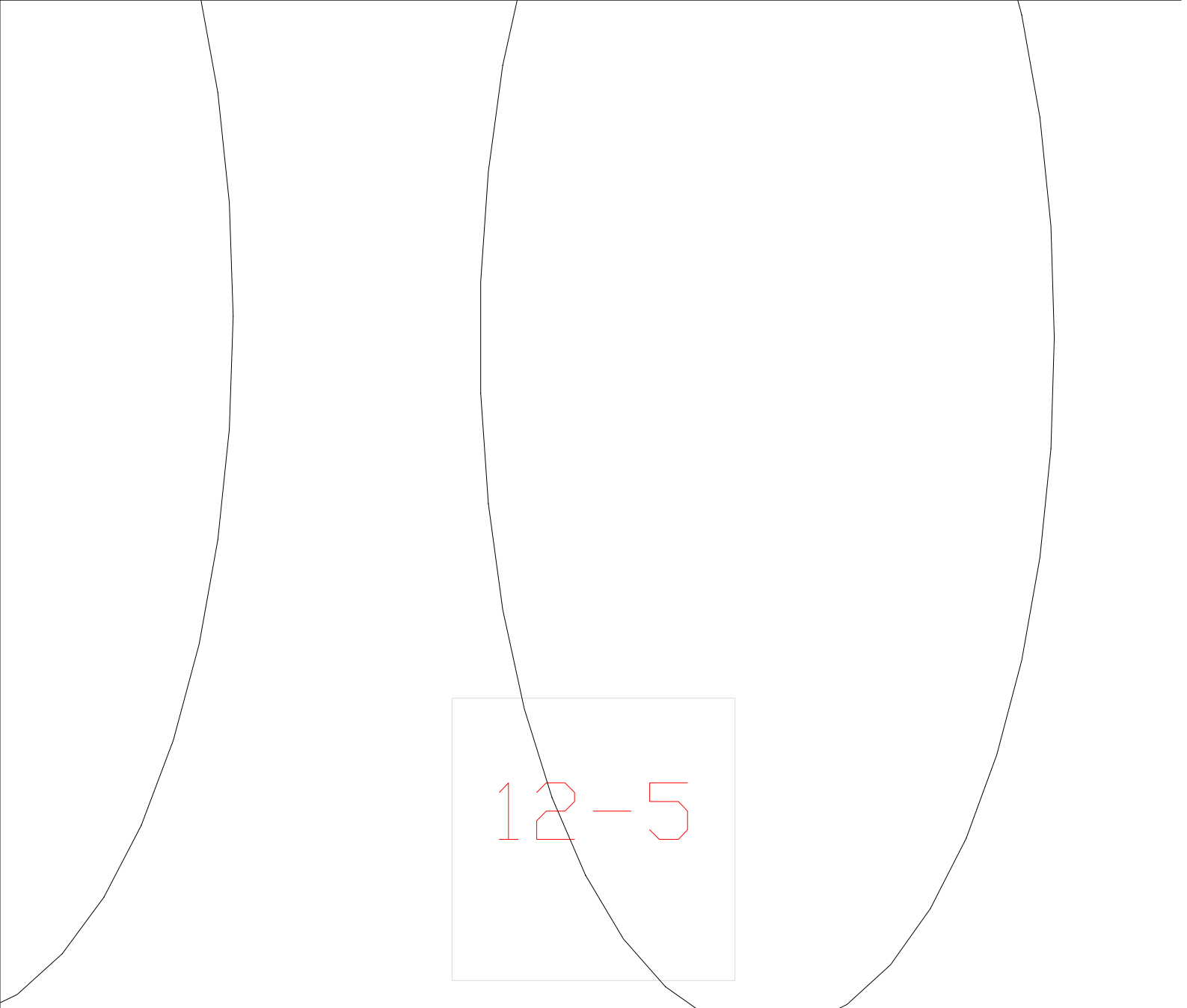

12-5

			⊕	
--	--	--	---	--

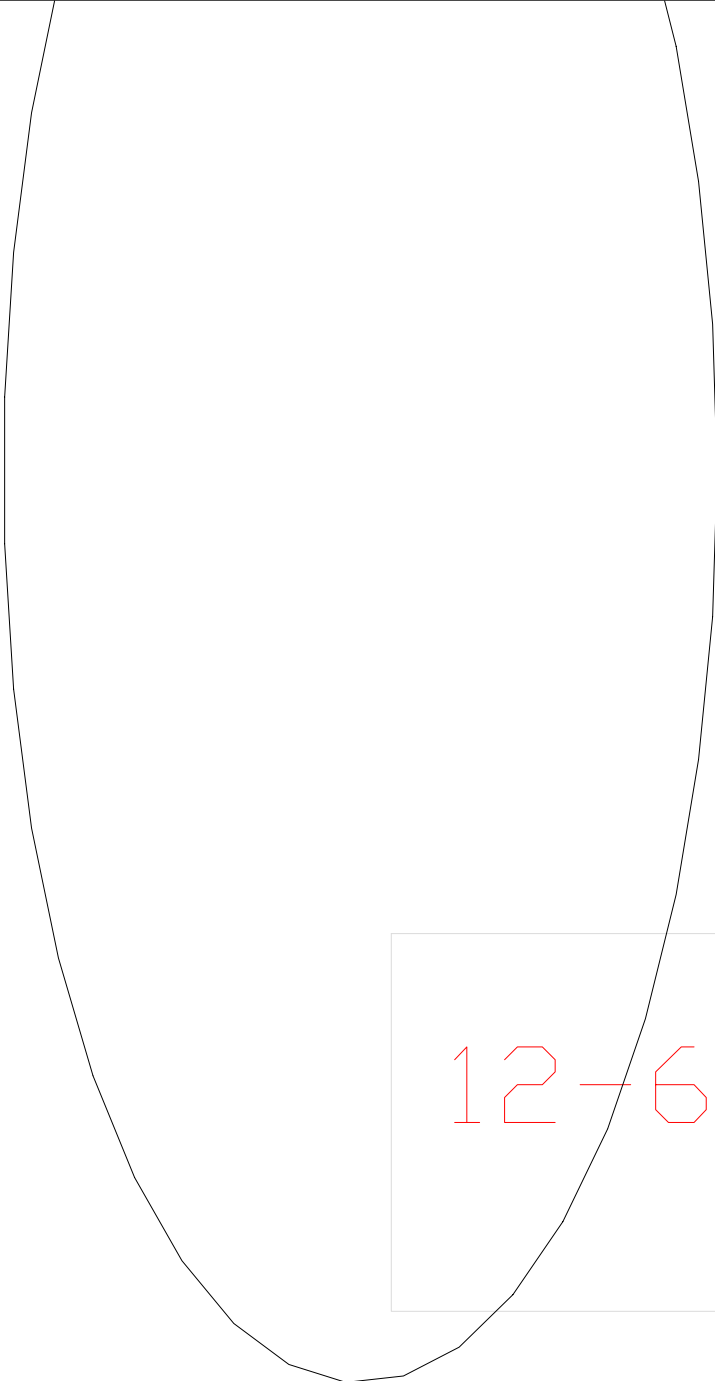

12-6

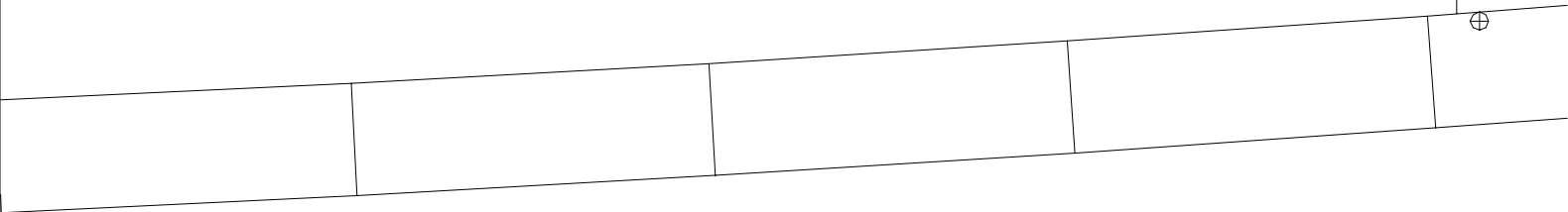

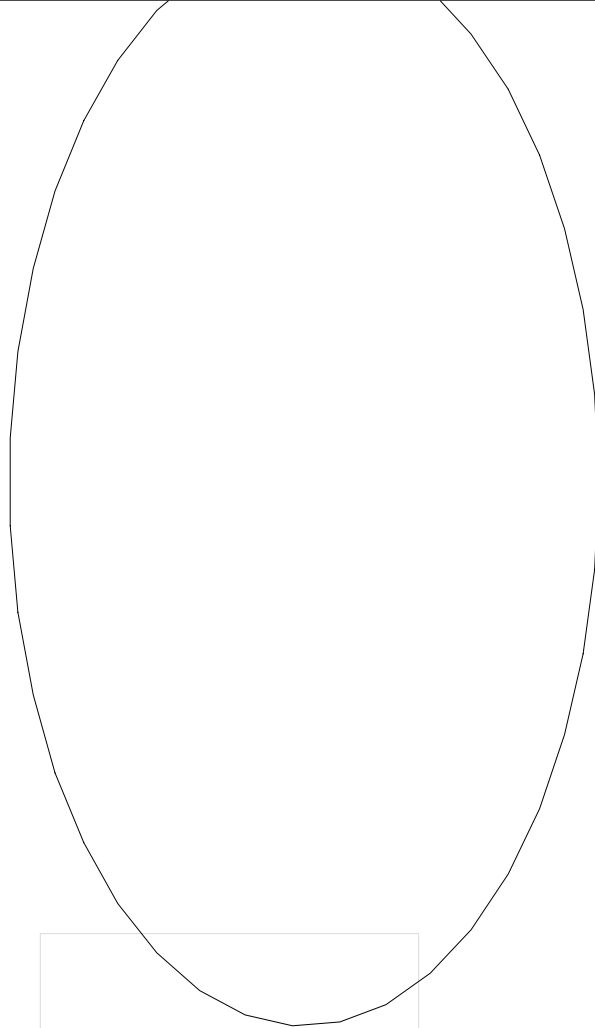

12-7

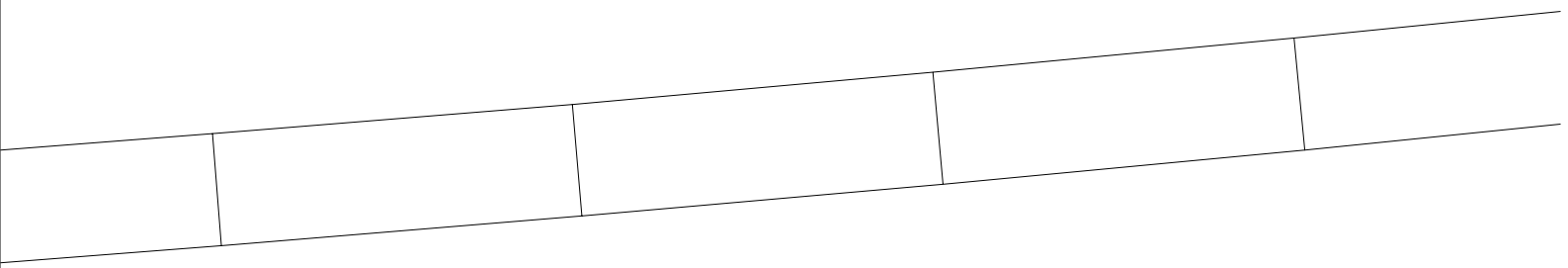

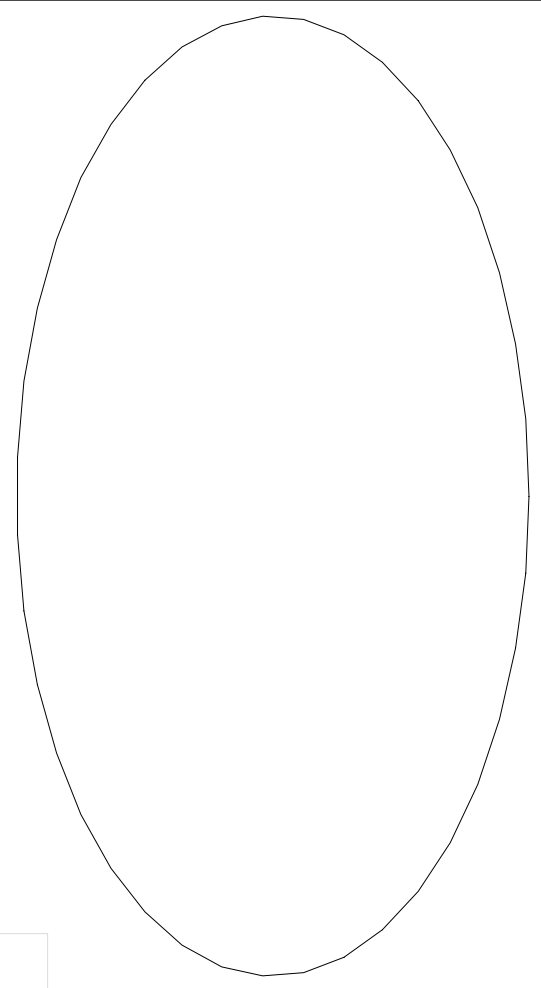
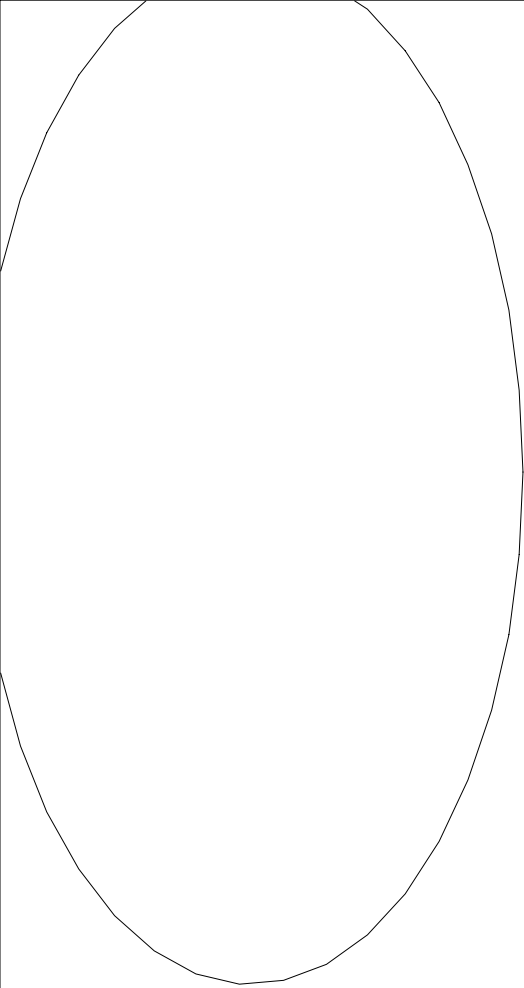

$$12 - 8$$

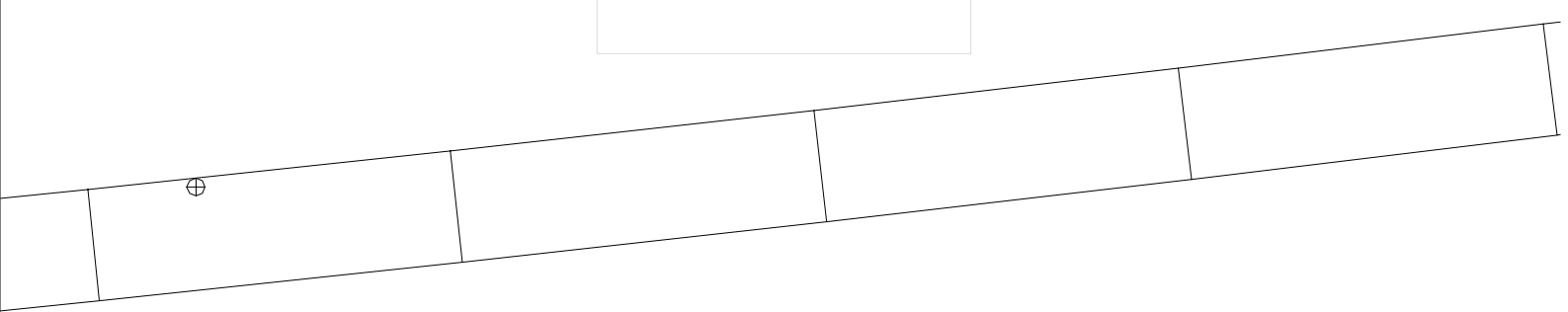



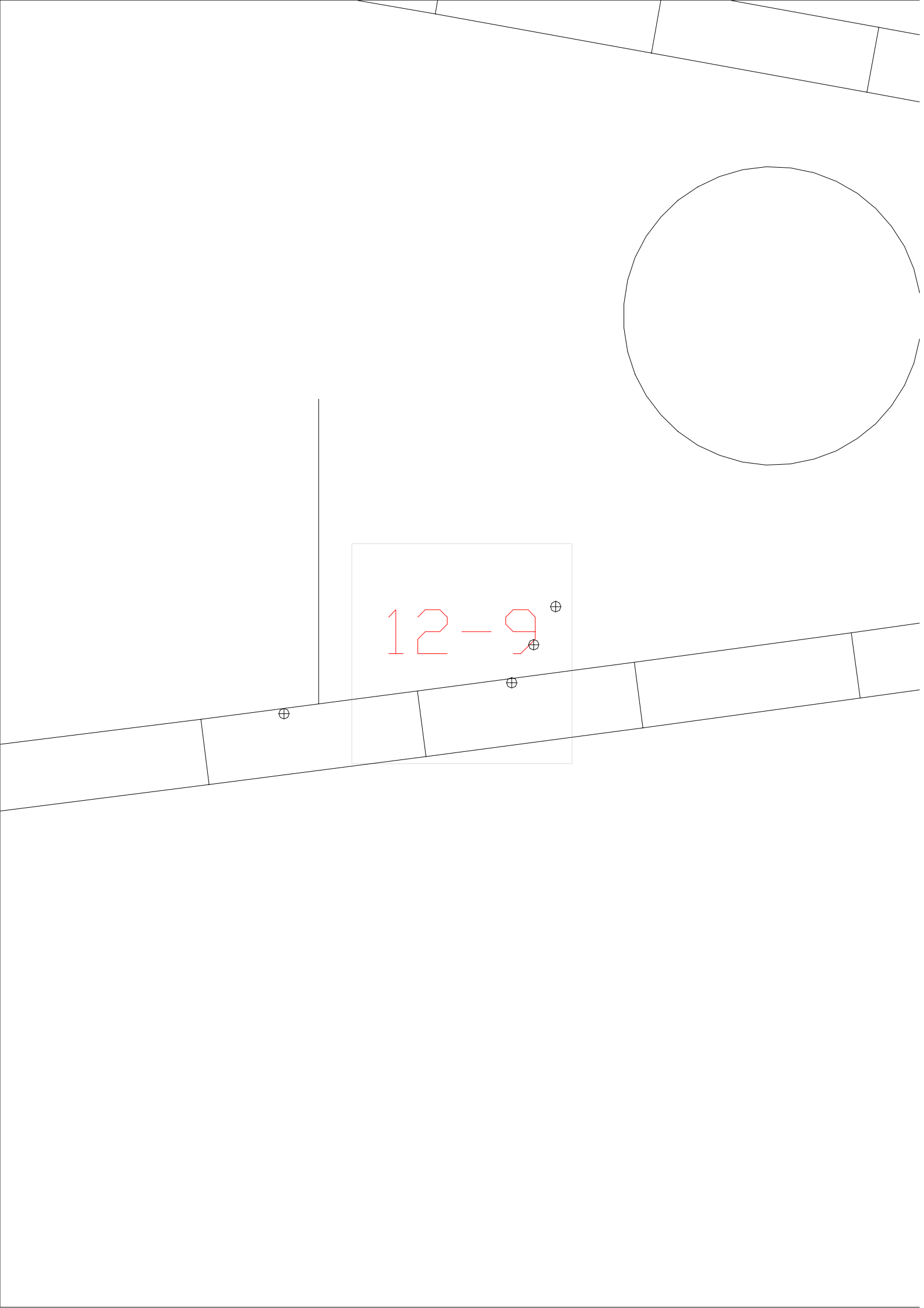

1-2

13-10



13-12

13-13

13-14

13-15



13-16

13-1

13-2

13-3

$$13 - 4$$

13-5

13-6

13-7



$$13 - 8$$

13-9

1-3

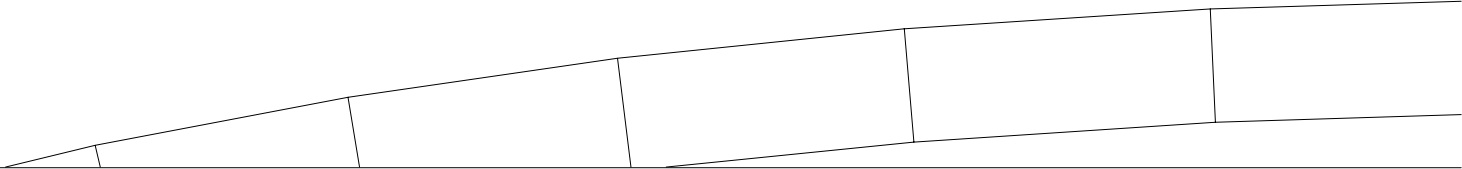

1-4

1-5

1-6

1-7

1-8



1-9

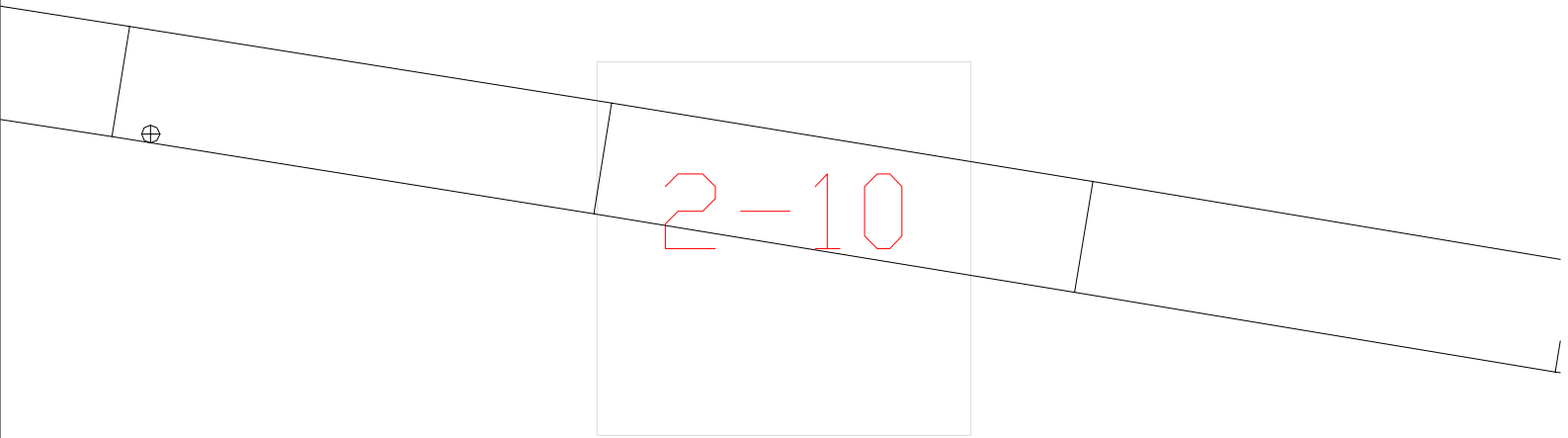

2-10

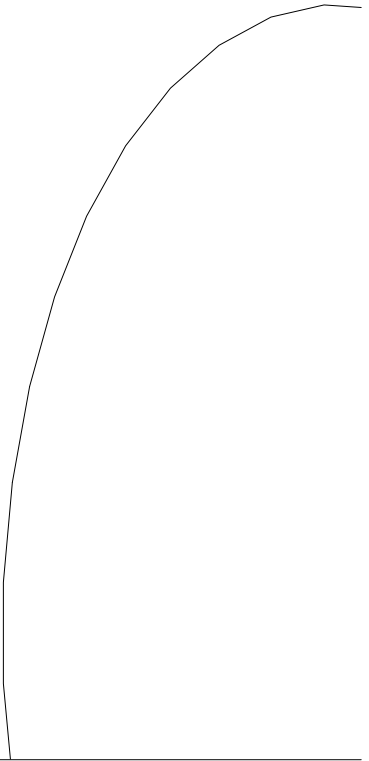
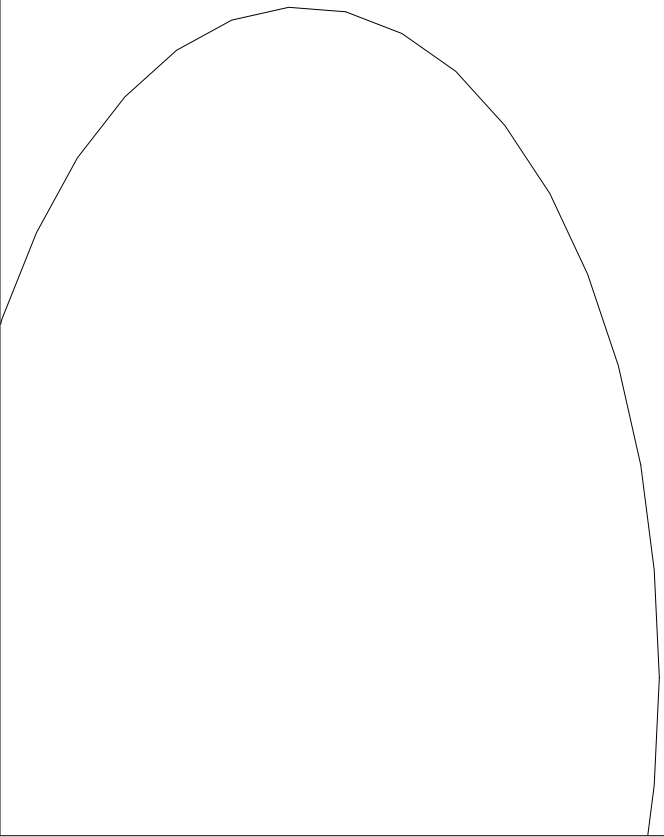

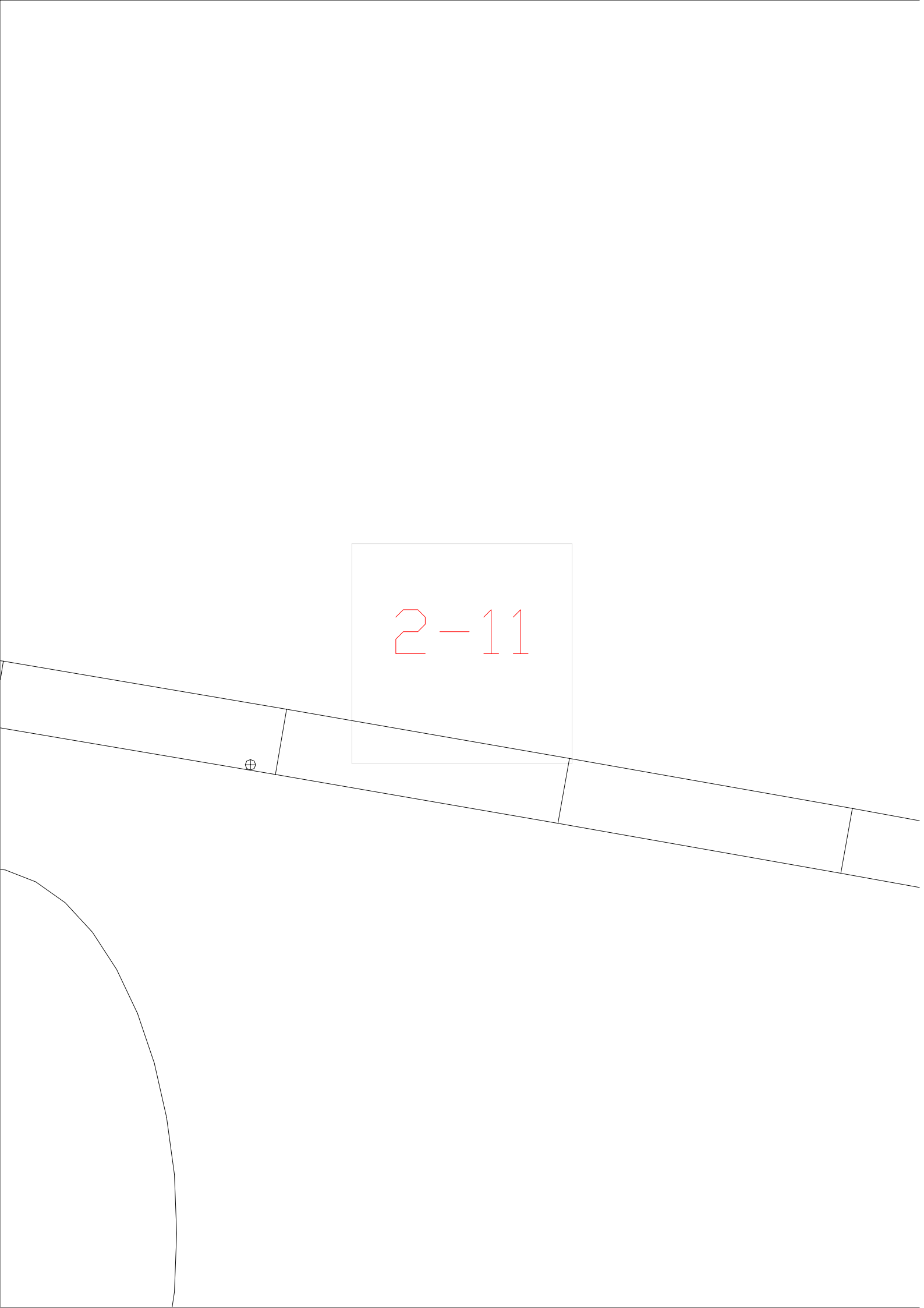

2-11

The image shows a technical drawing of a tapered shaft. The shaft is oriented horizontally and tapers from left to right. It features a square hole that also tapers along its length. A fillet is present at the bottom-left corner of the shaft. A small circle with a cross inside is located on the shaft's surface. A rectangular box highlights the text '2-11' in red.

2-12

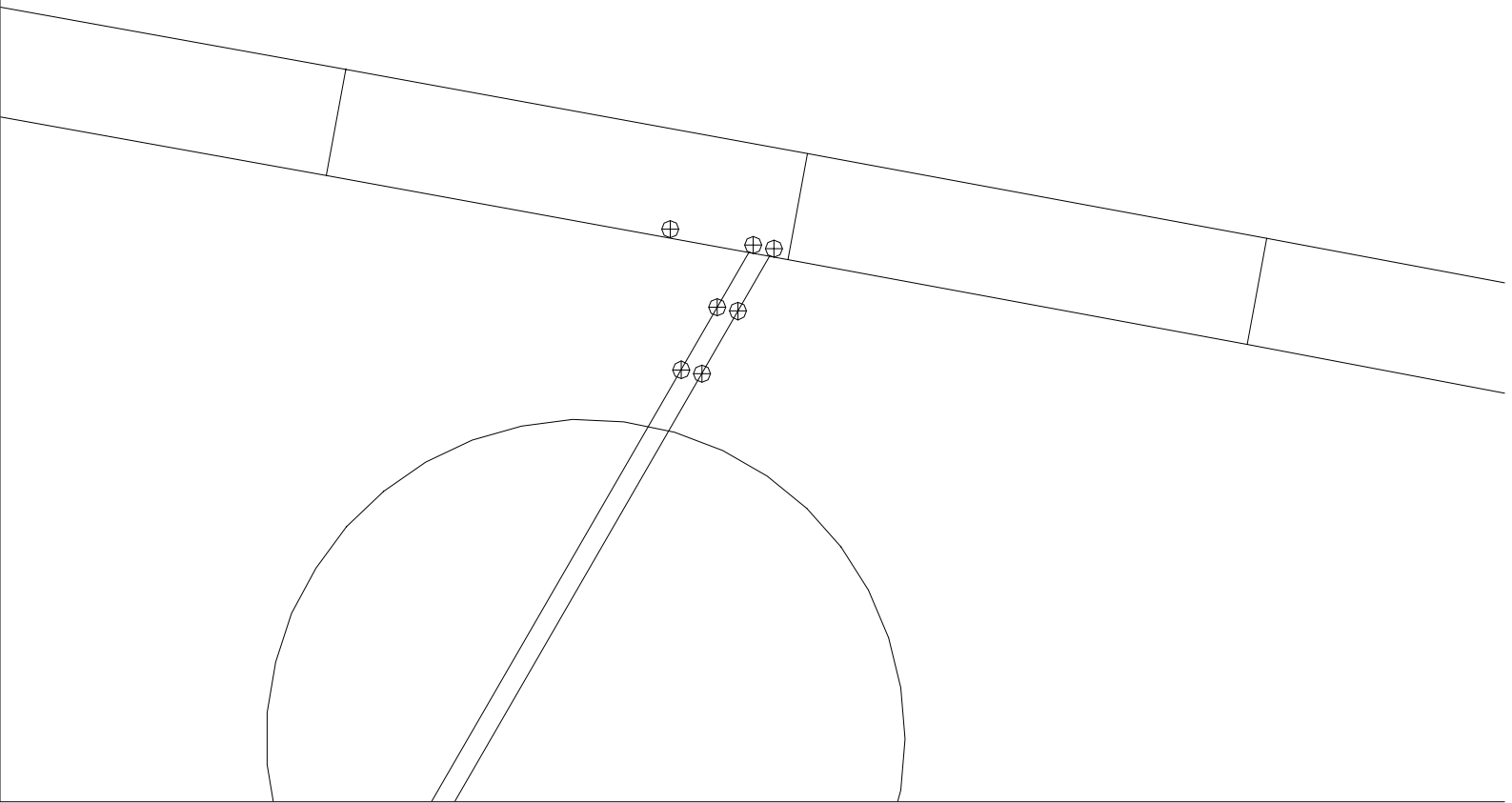

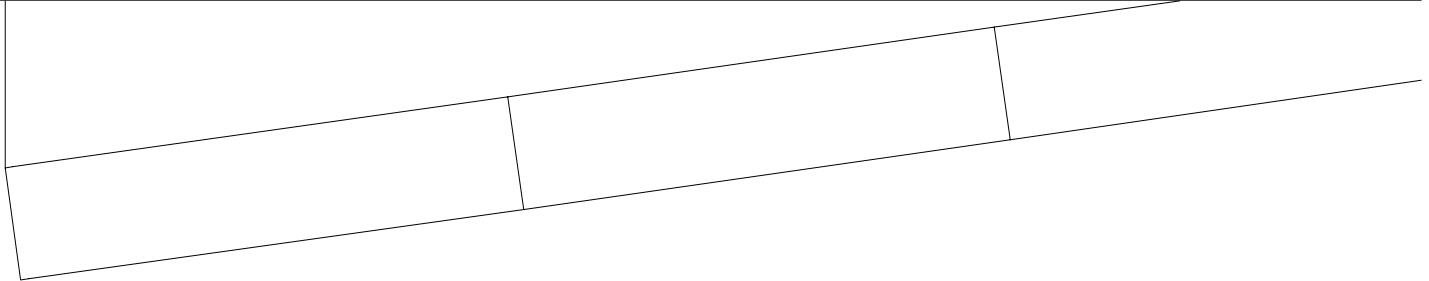

2-13

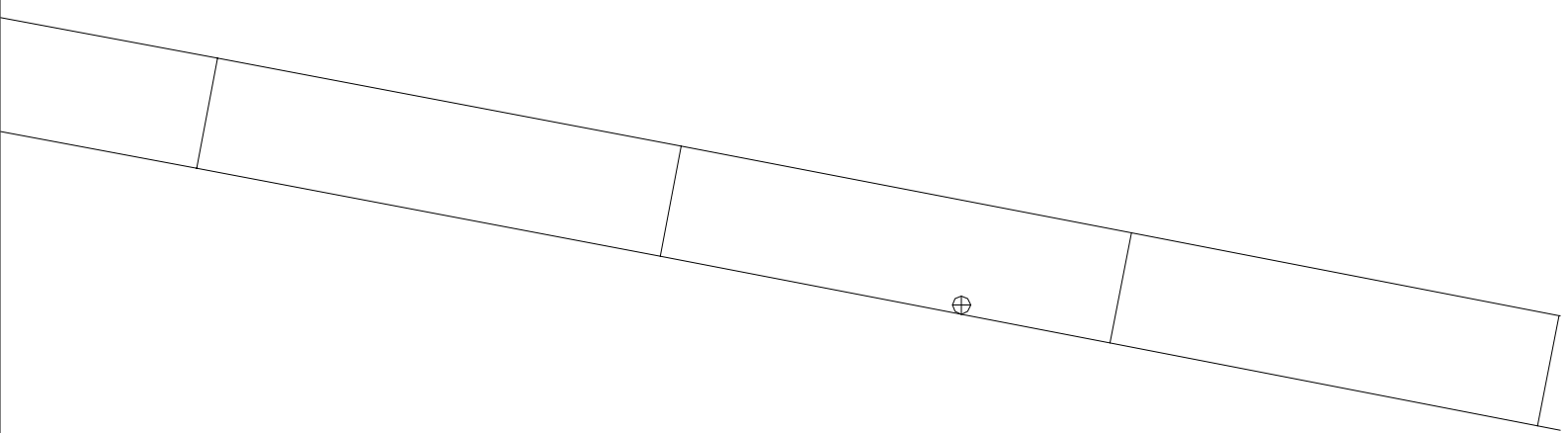

2-14

2-15

2-16



2-1

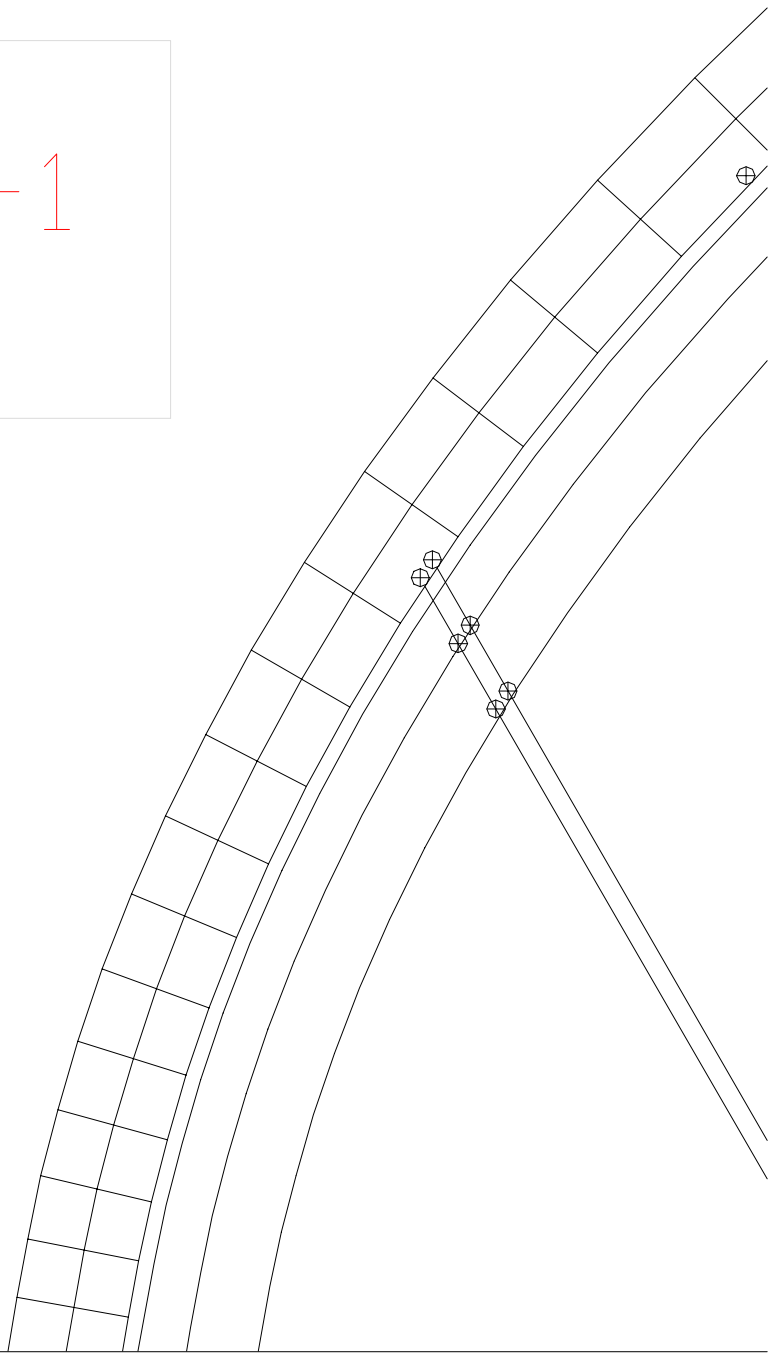

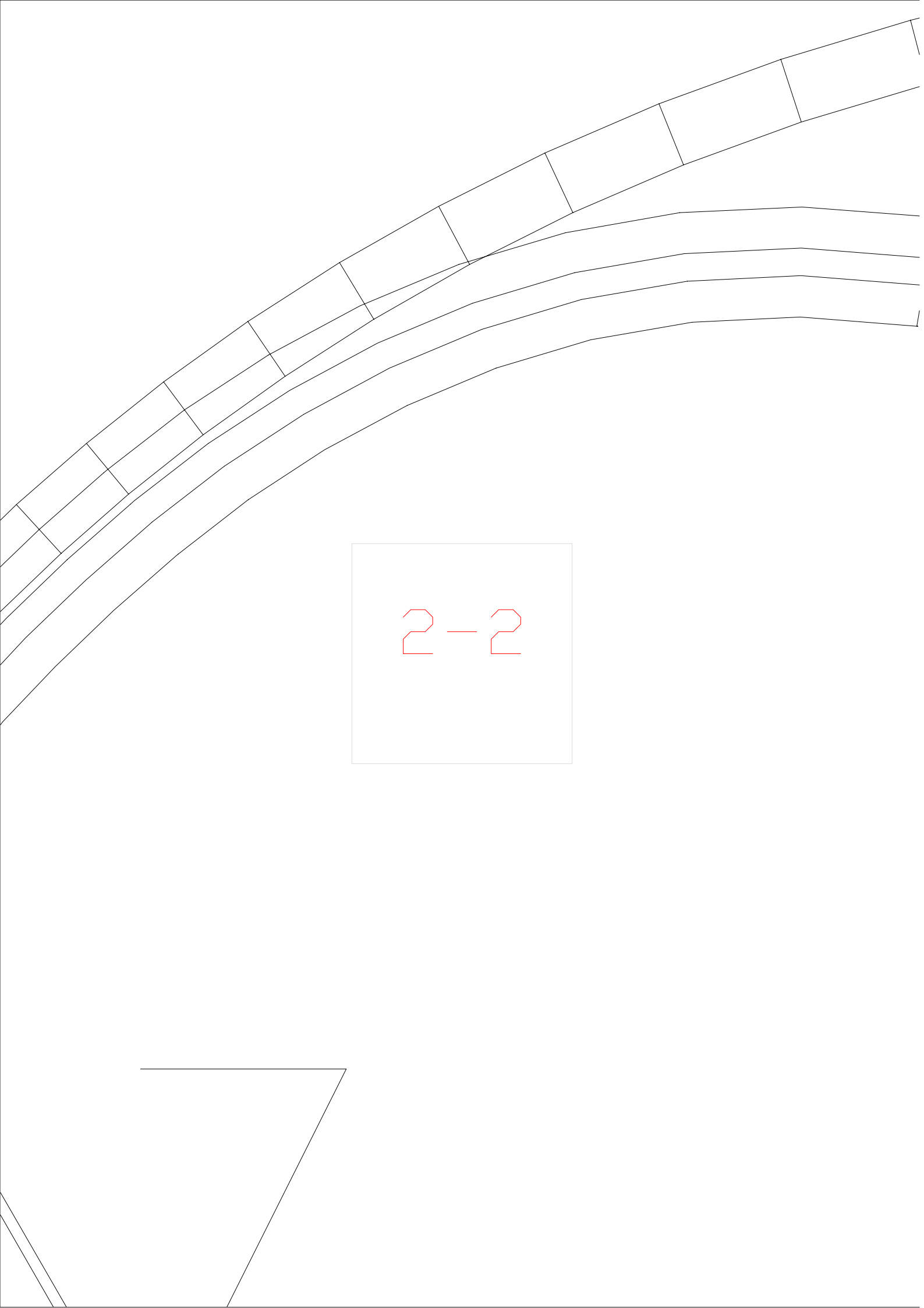

2-2



2-3

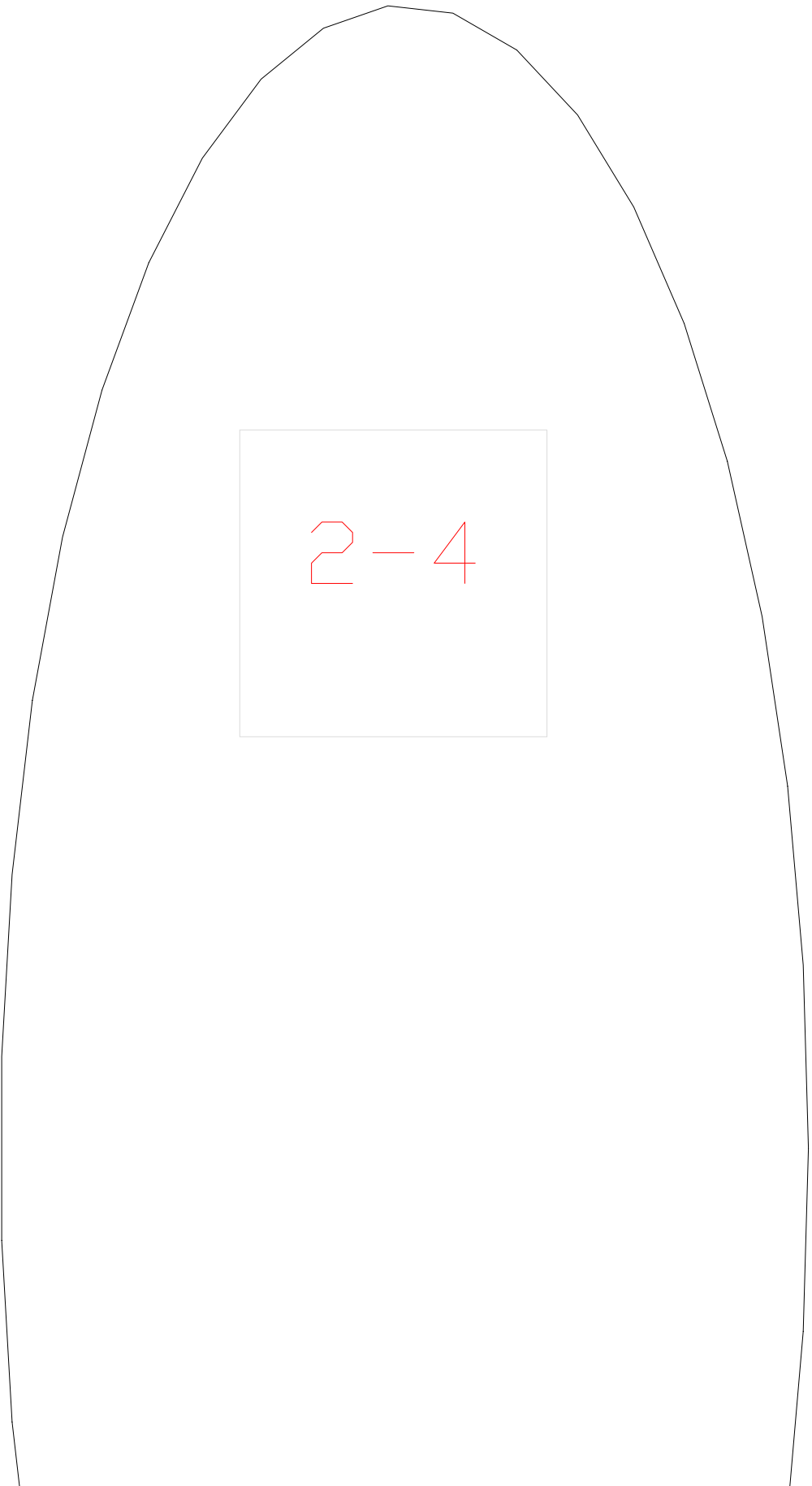

2-4

⊕

2-5

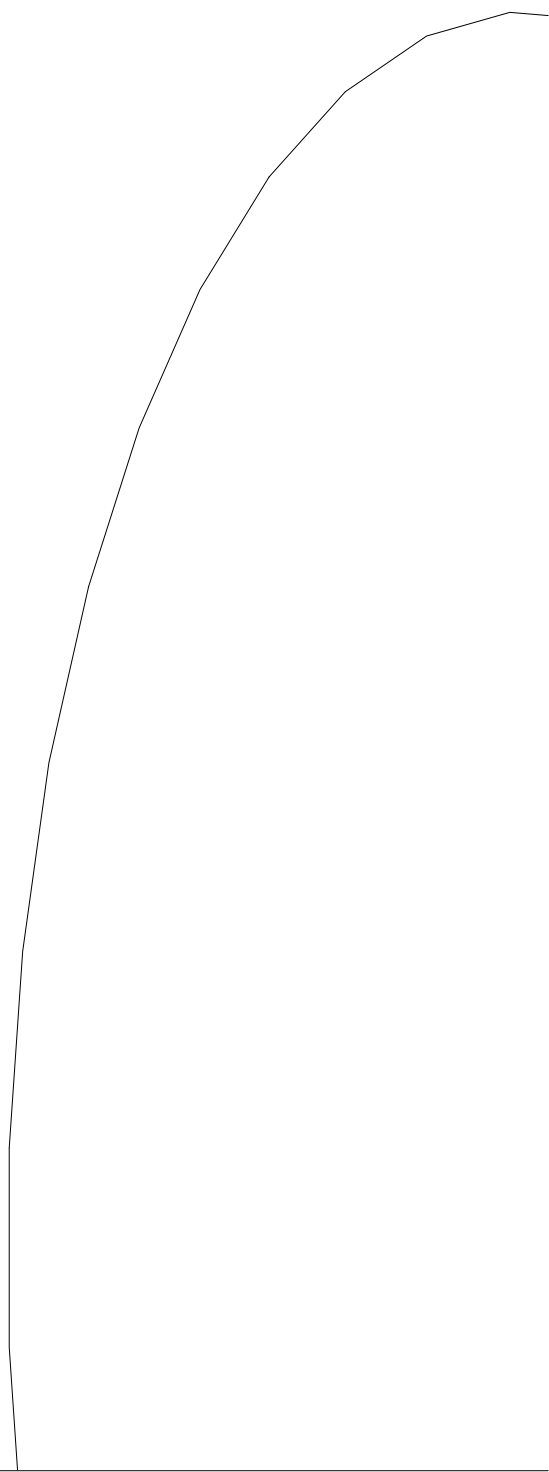

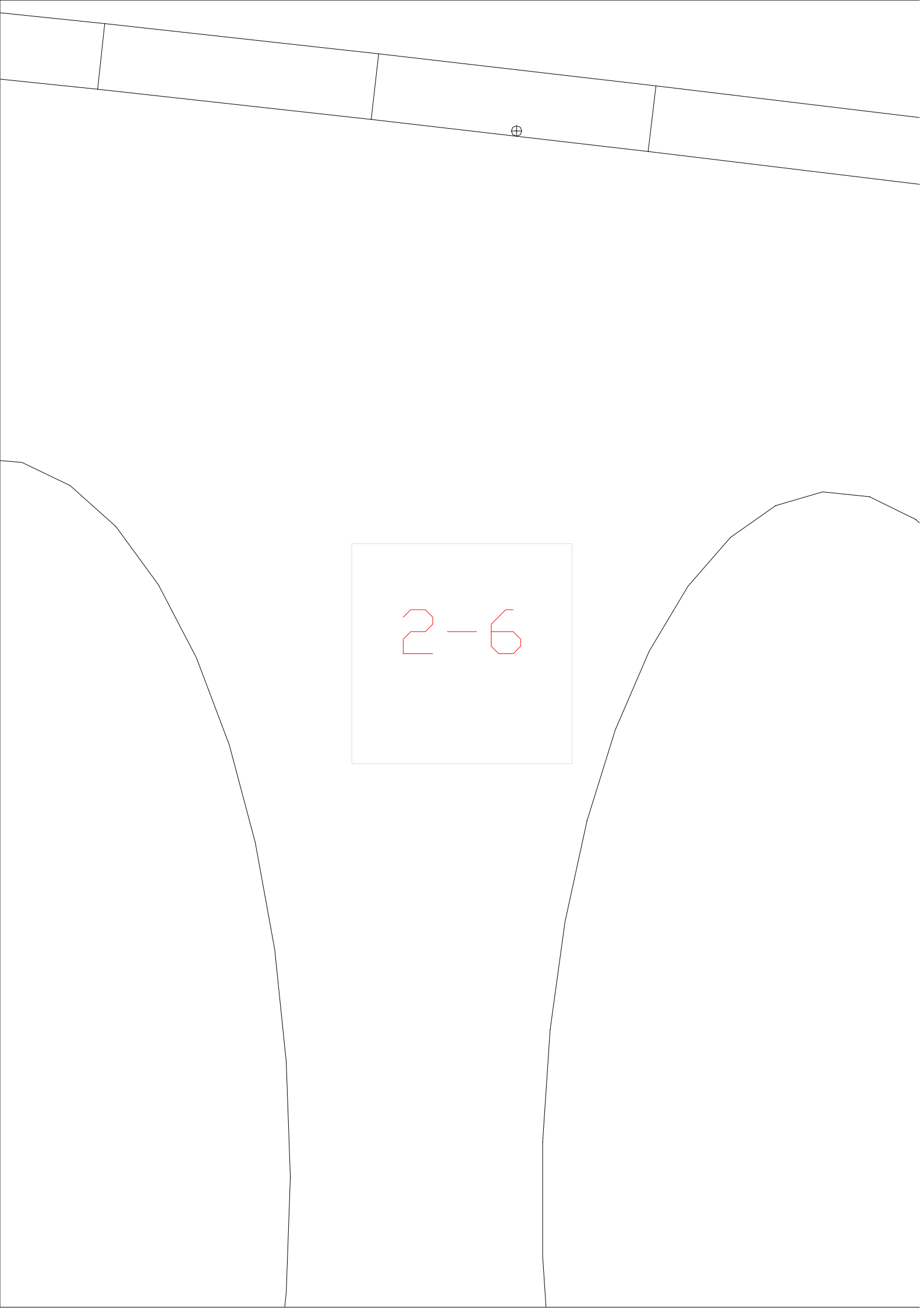

2-6

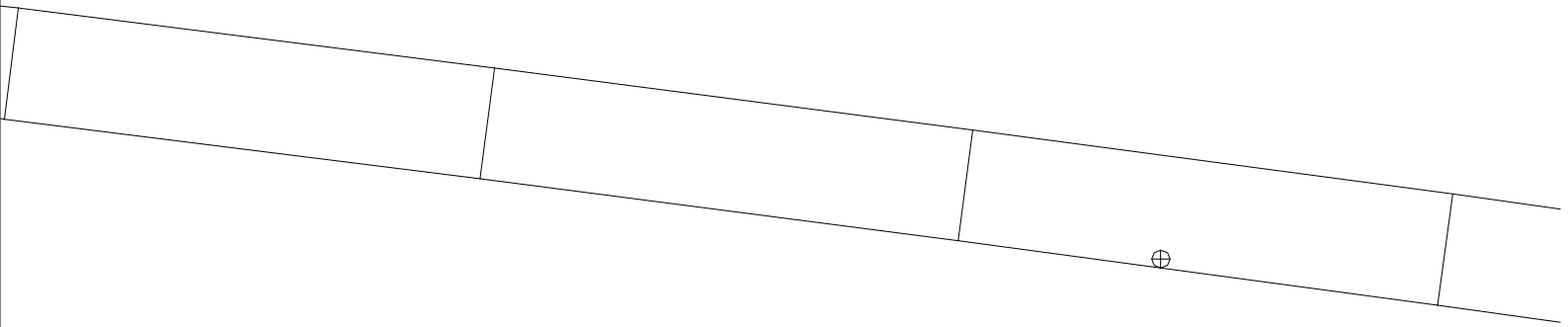

2-7

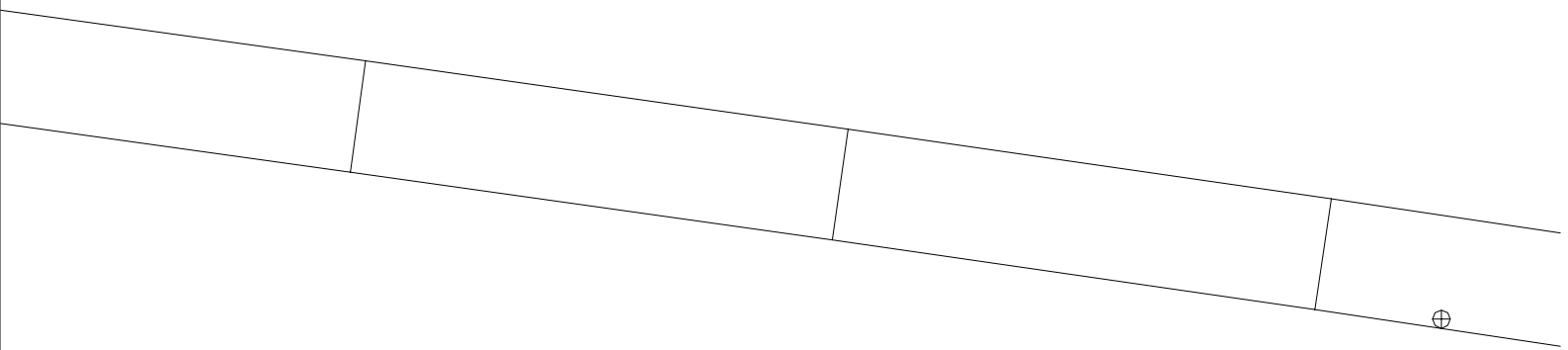

2-8



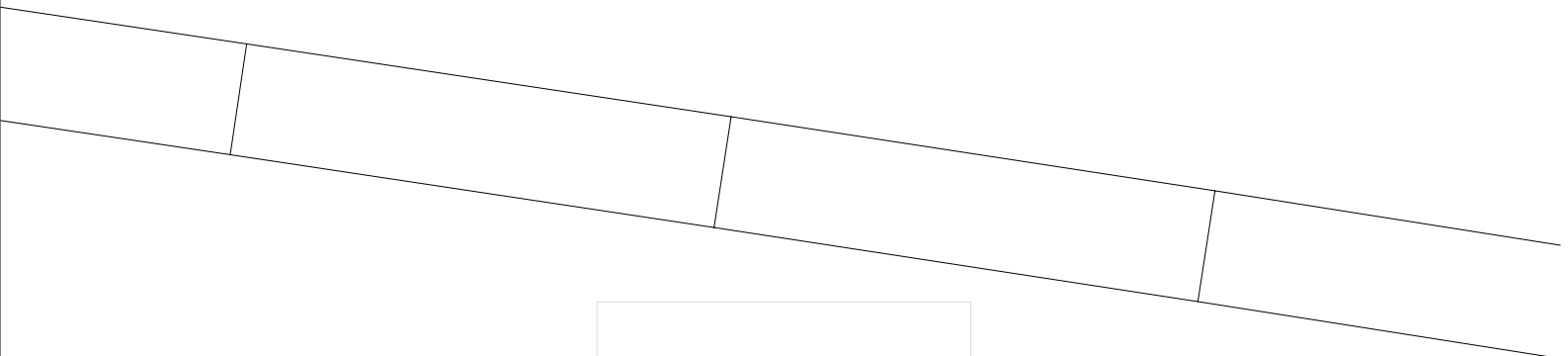

2-9

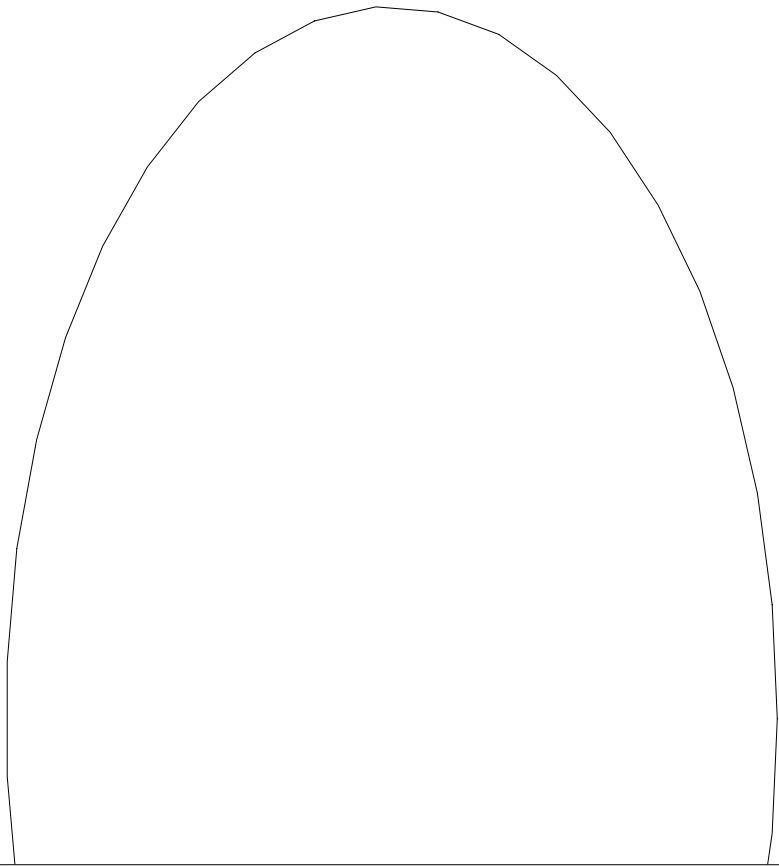

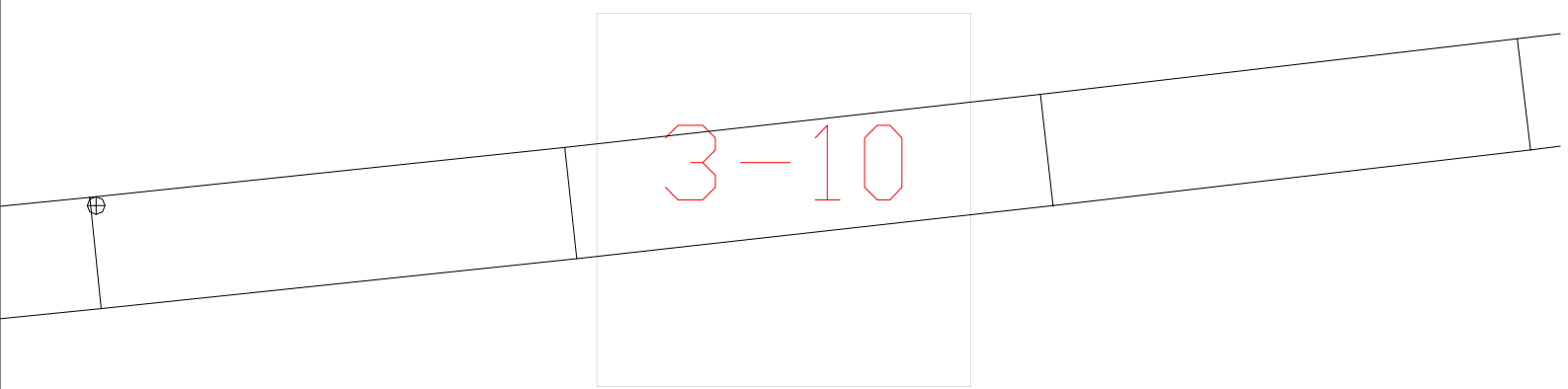
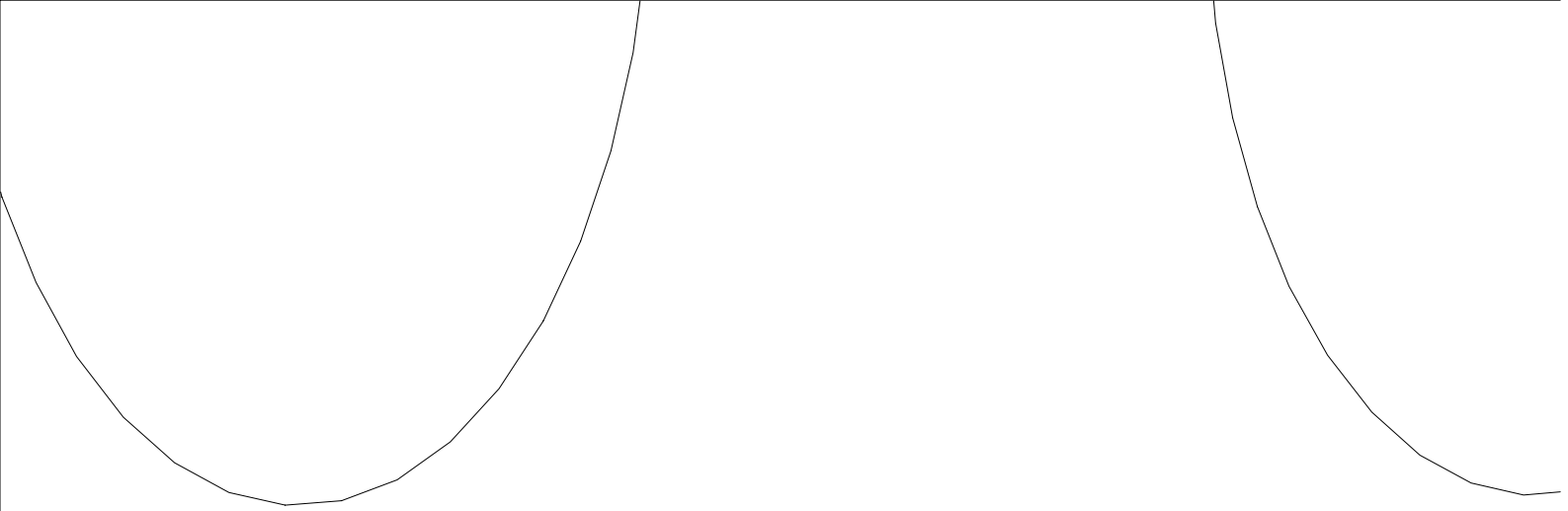

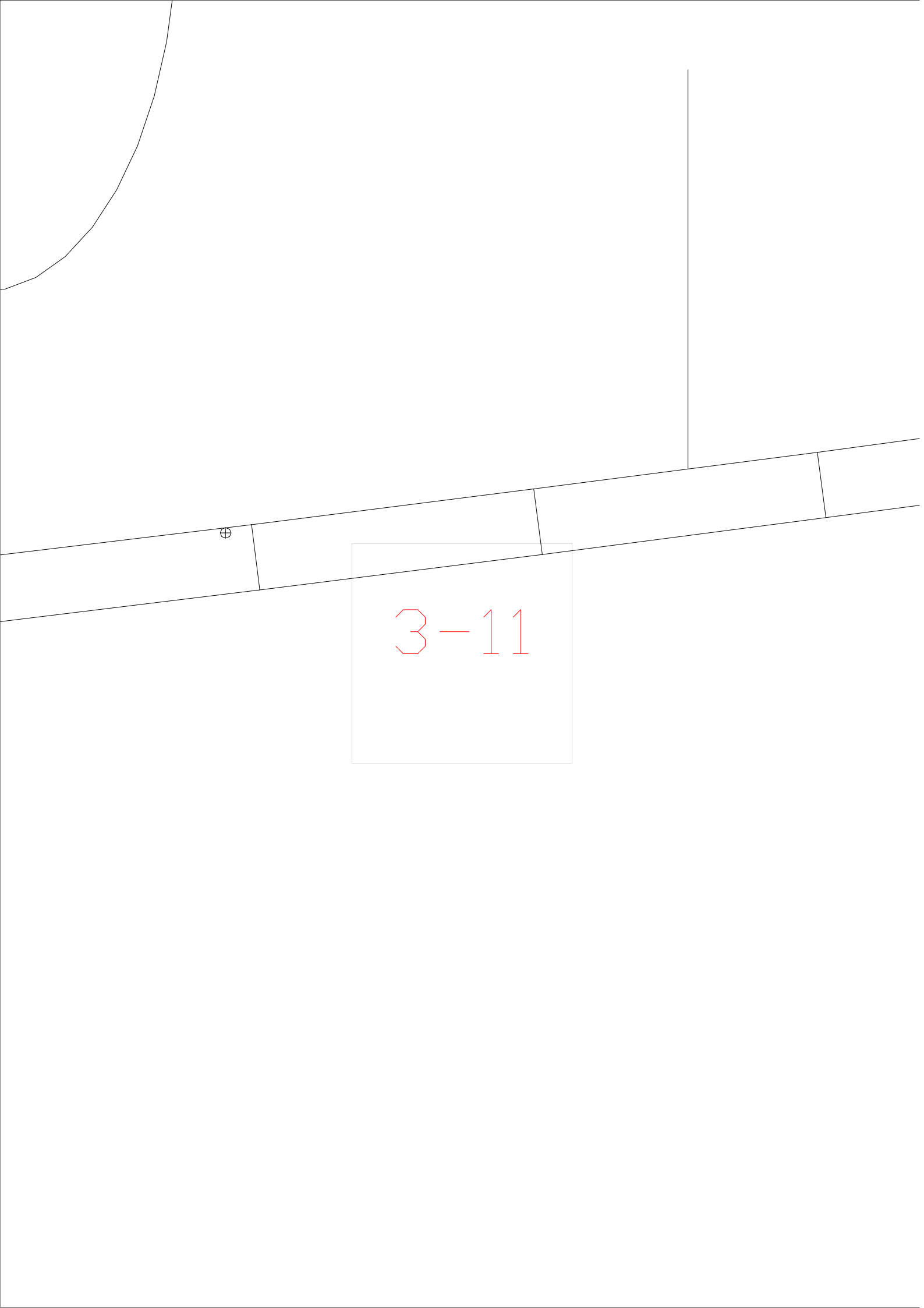

3-11

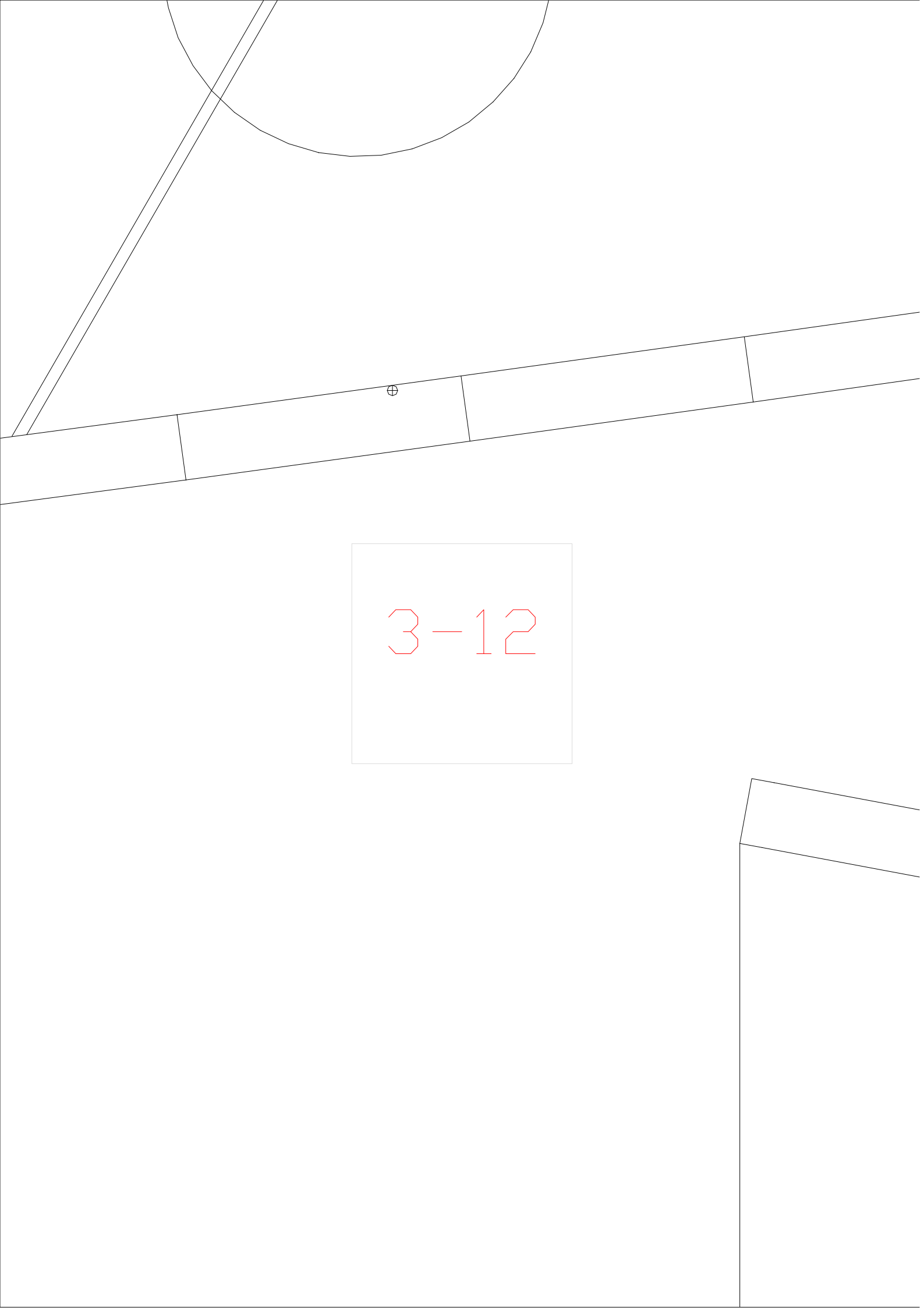

3-12

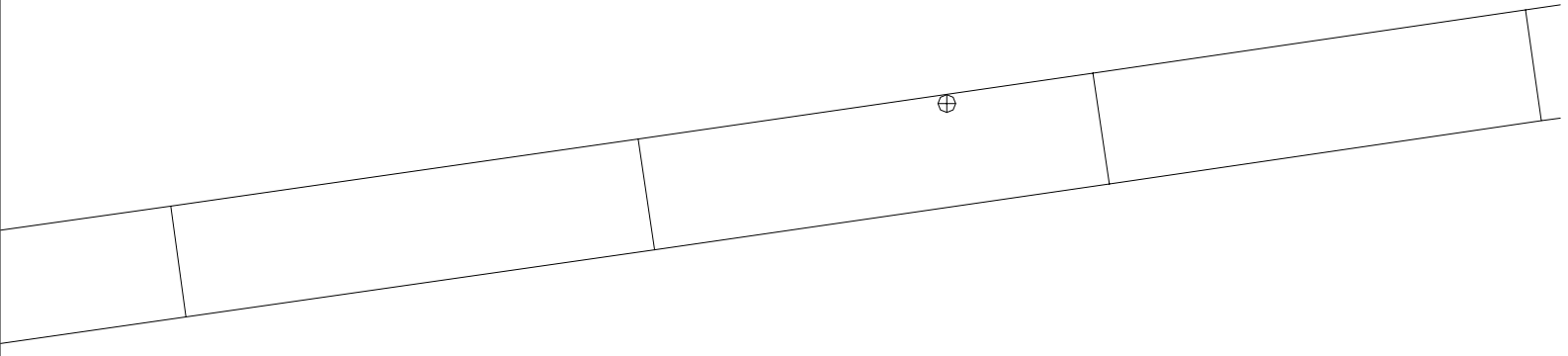

3-13

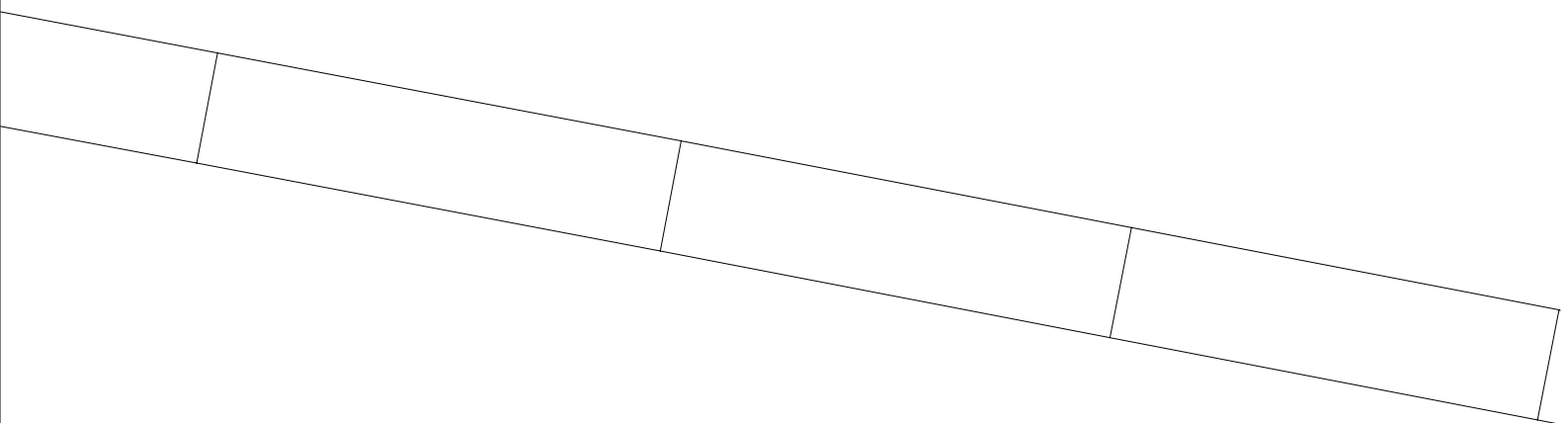

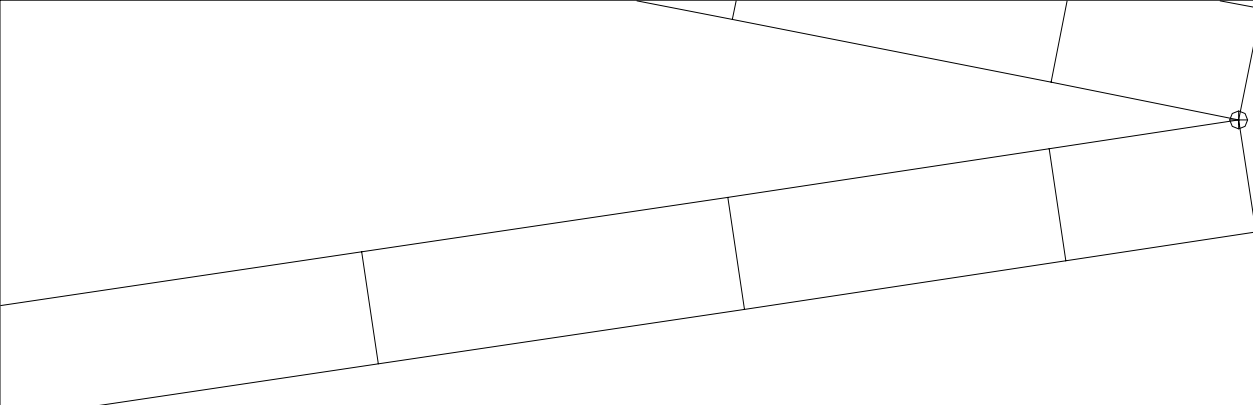

3-14

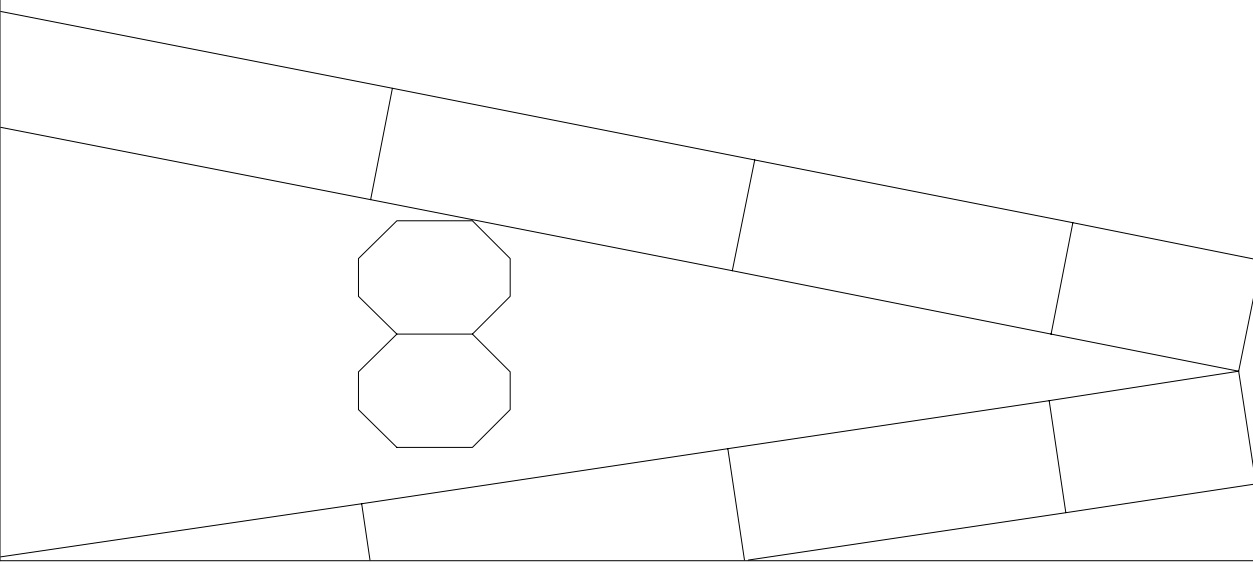

3-15

3-16



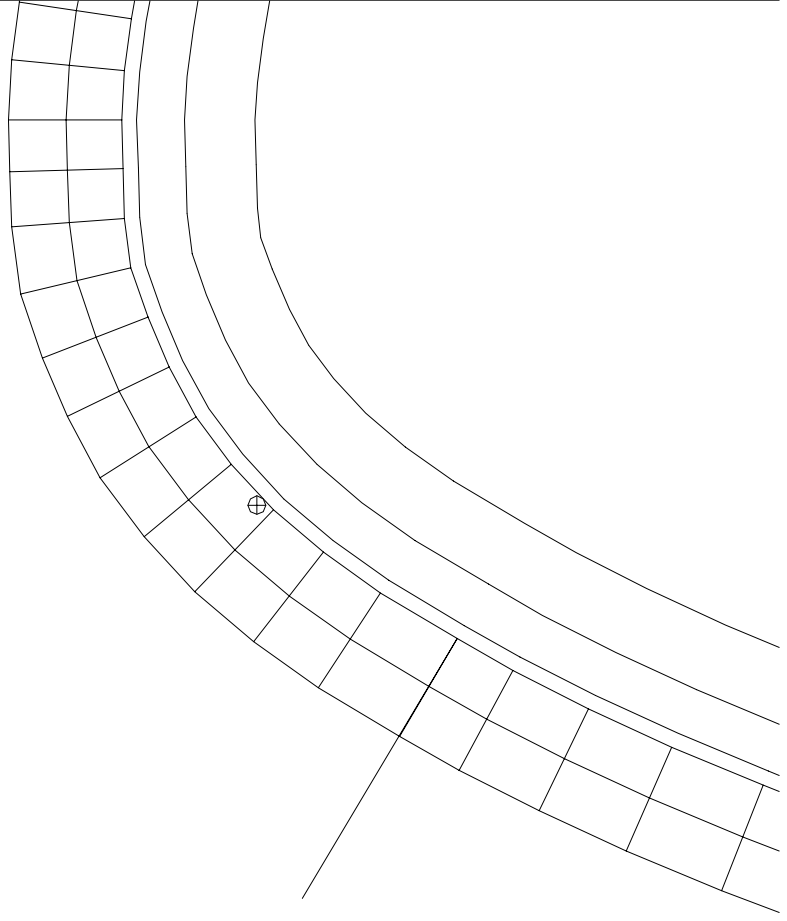

3-1

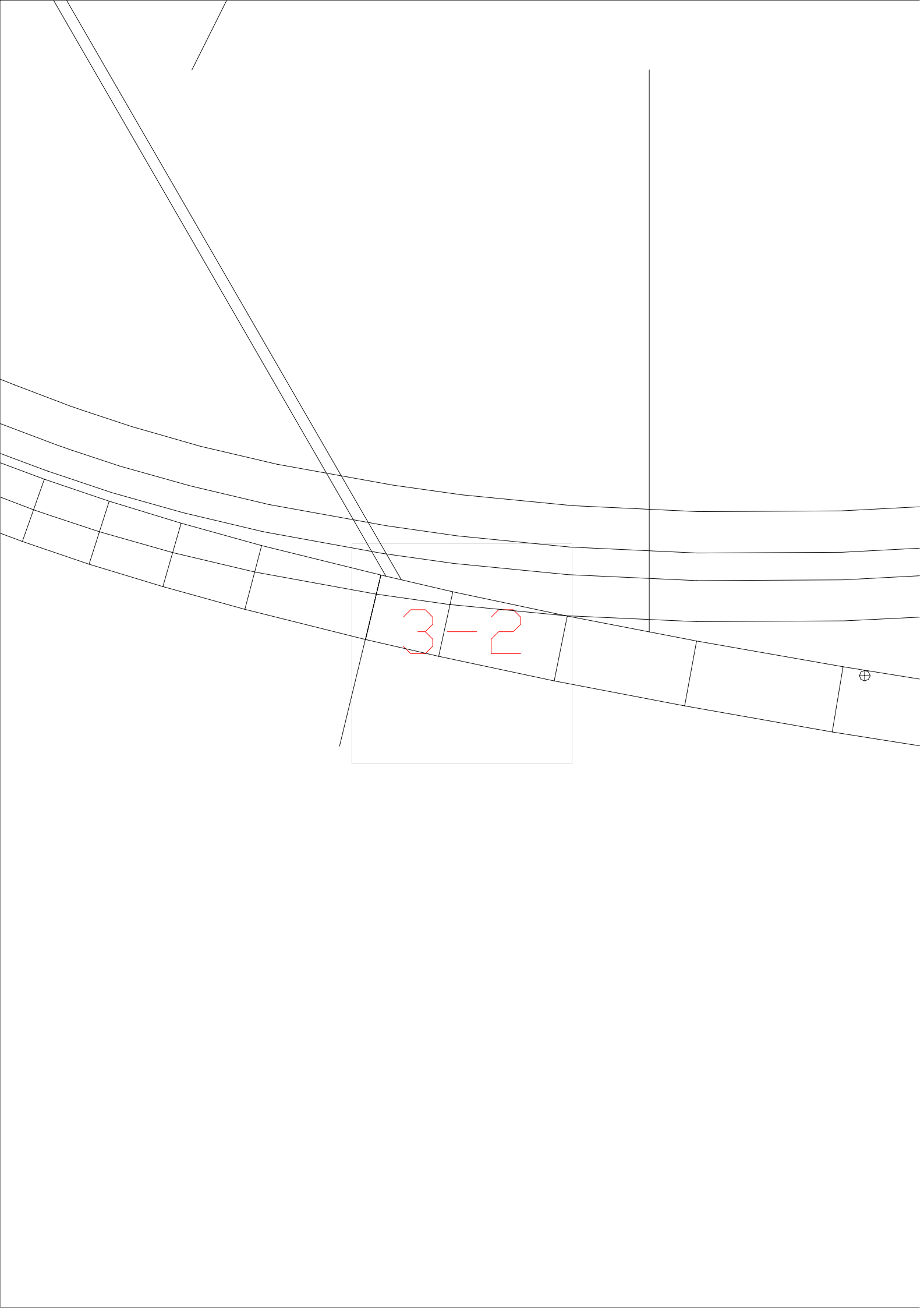

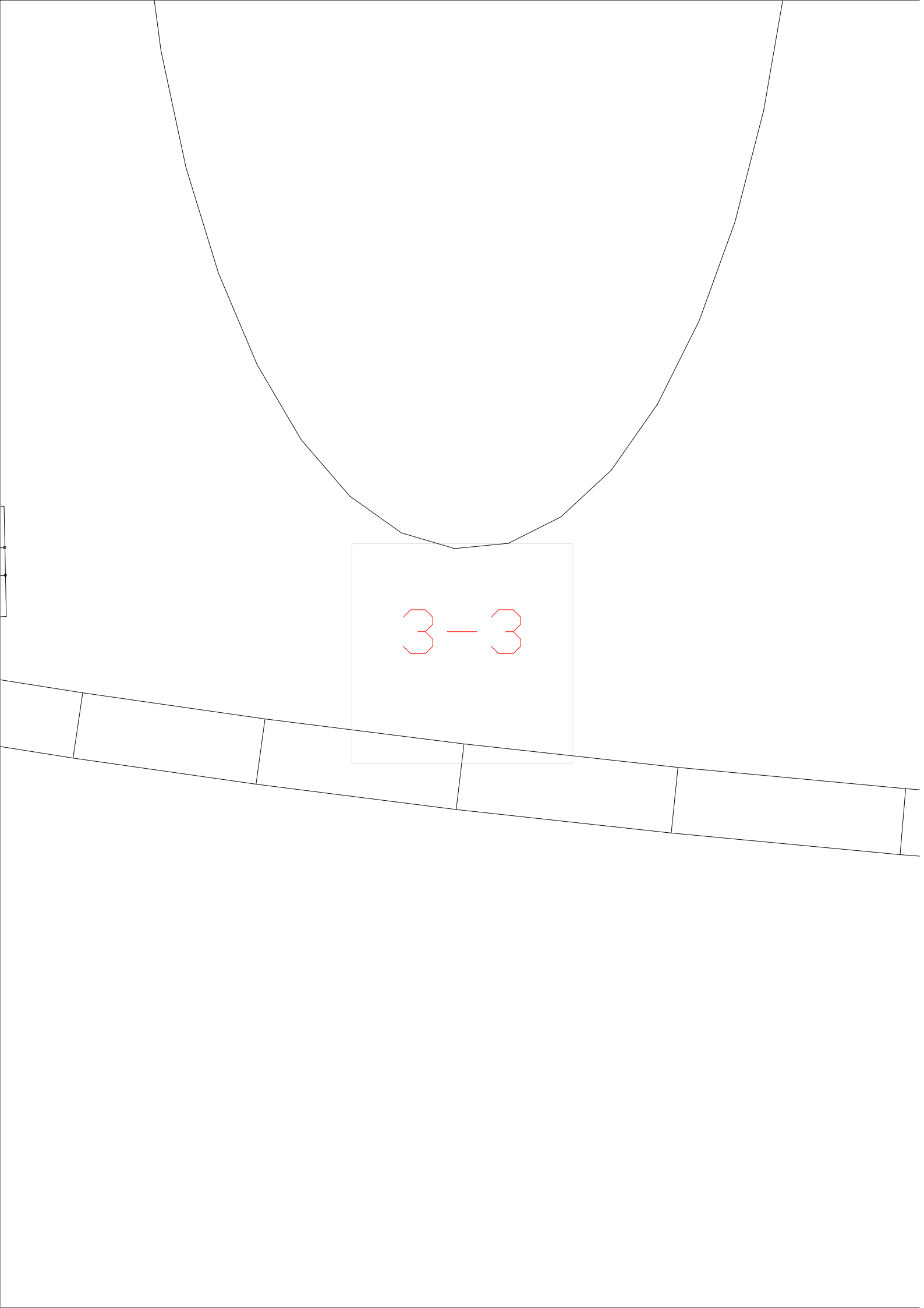

3-3



3-4

3-5

⊕



3-6

		⊕	
--	--	---	--

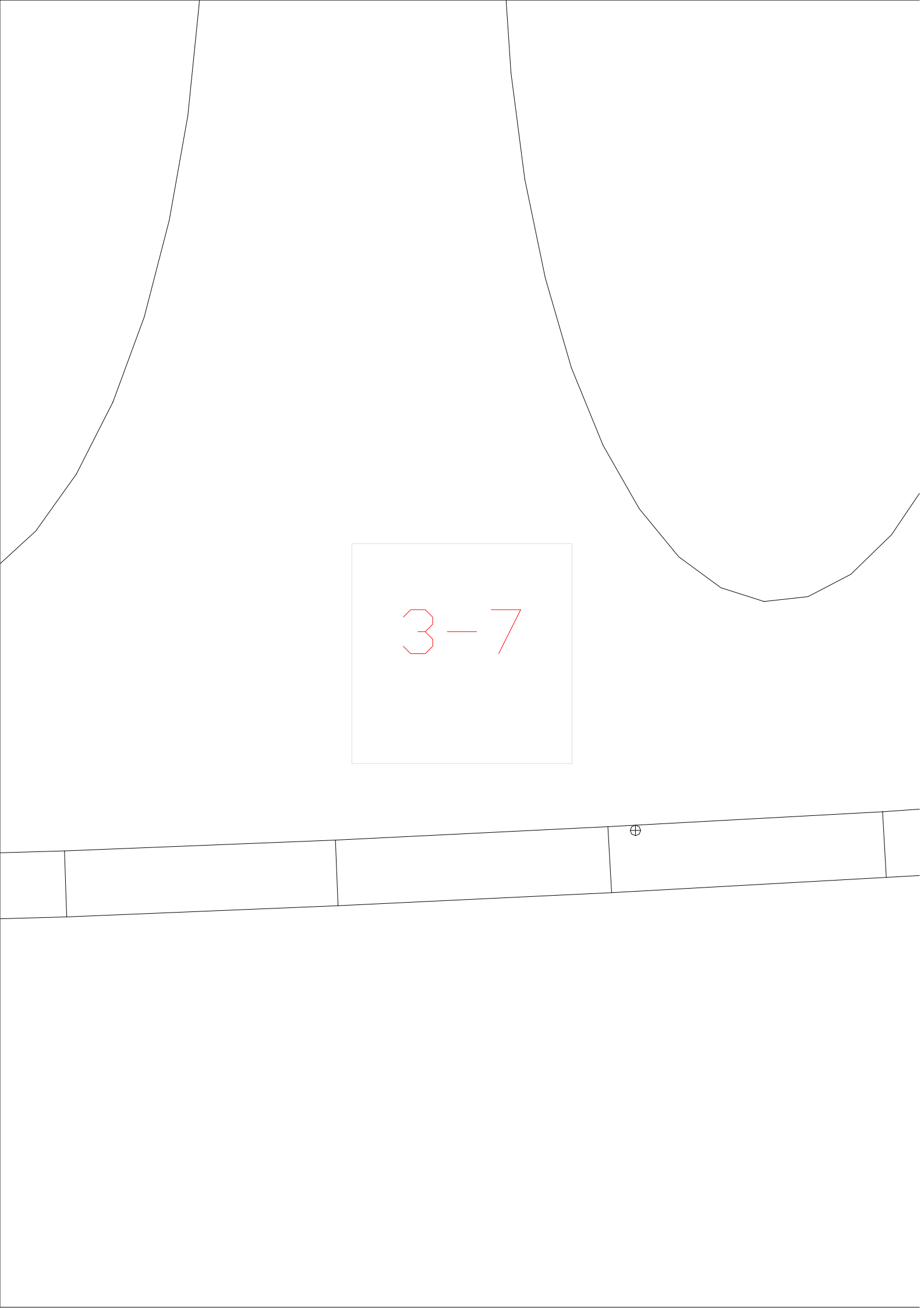

3-7

		⊕	
--	--	---	--



3-8

The image shows a technical drawing of a mechanical part. The part has a cylindrical body with a chamfered edge on the right side. A hole is located in the center of the cylindrical body. The drawing is divided into three sections by vertical lines. The central section is shaded gray. The text '3-8' is written in red in the center of the drawing. A small circle with a cross inside is located on the right side of the drawing.





3-9

4-10

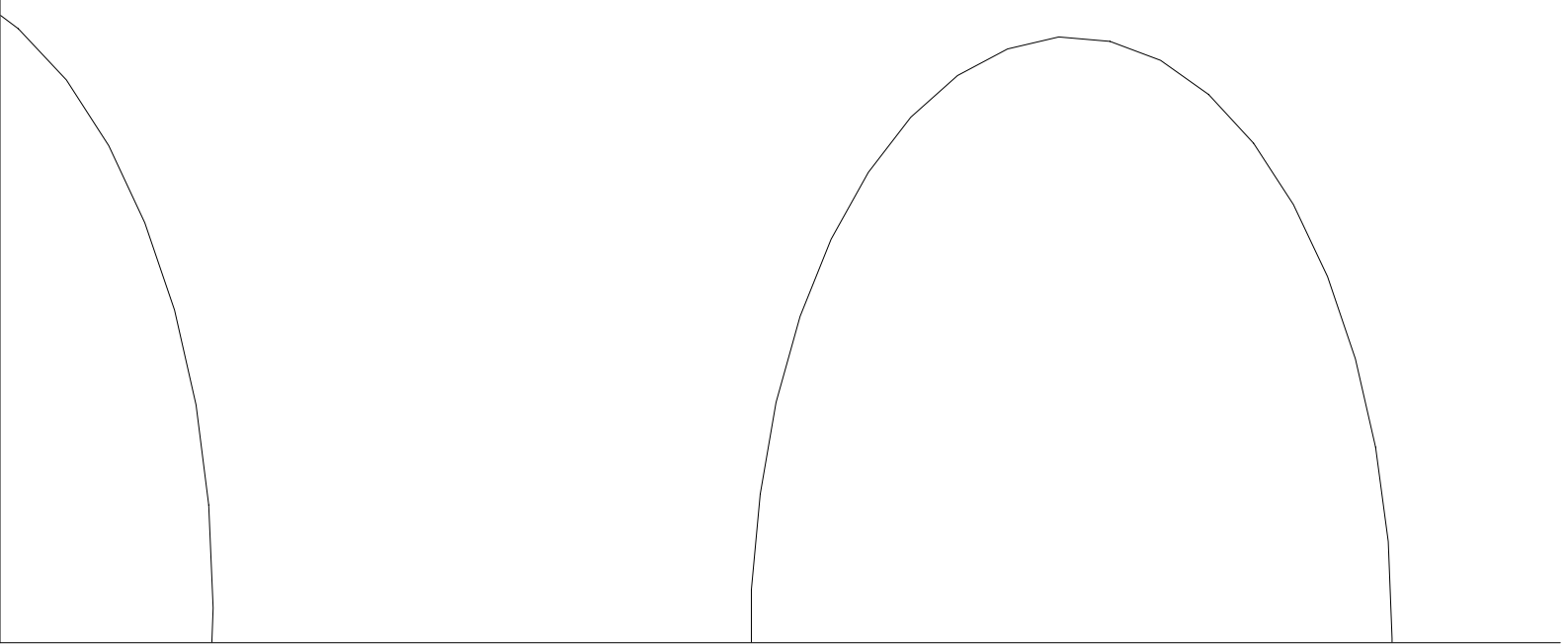
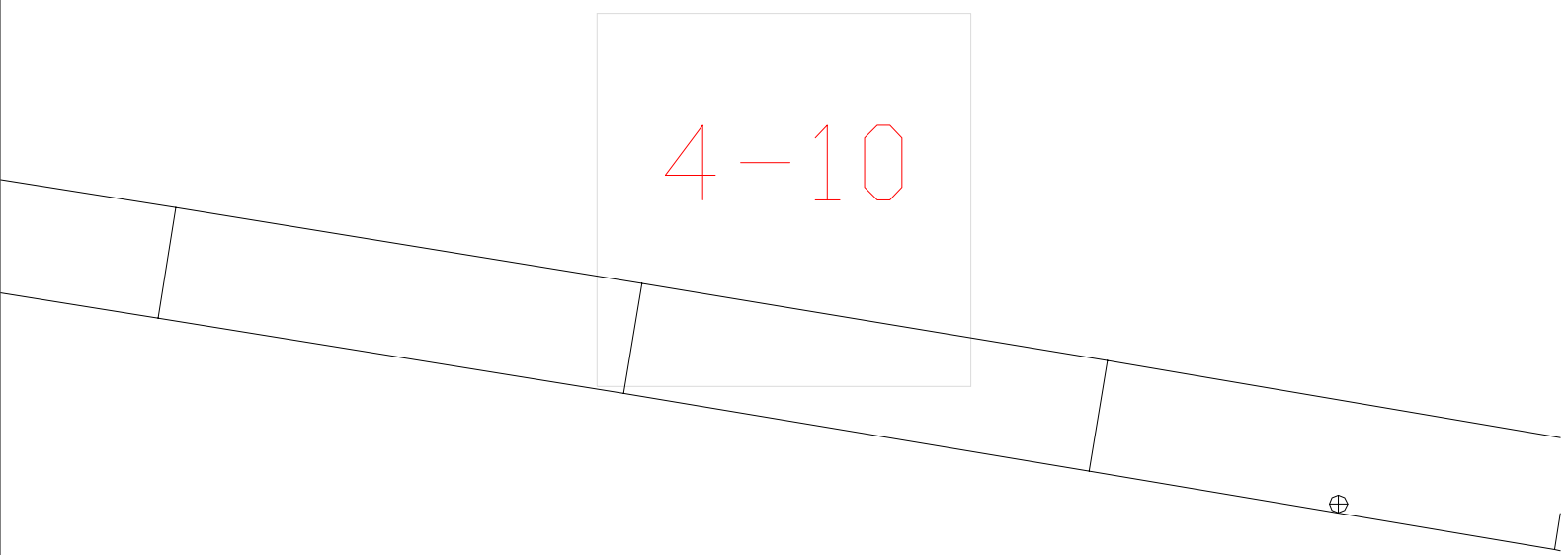

4-11

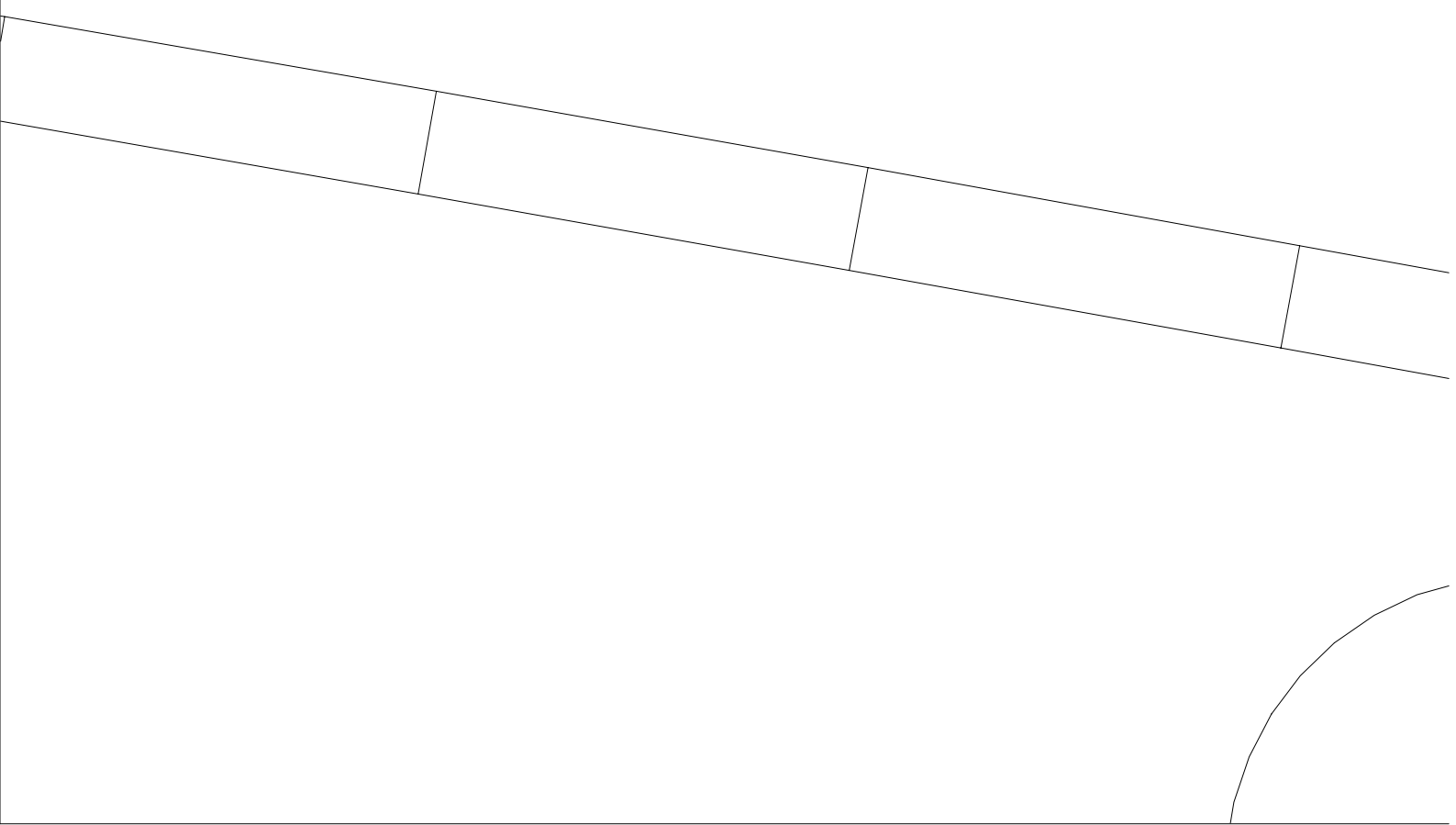

4-12

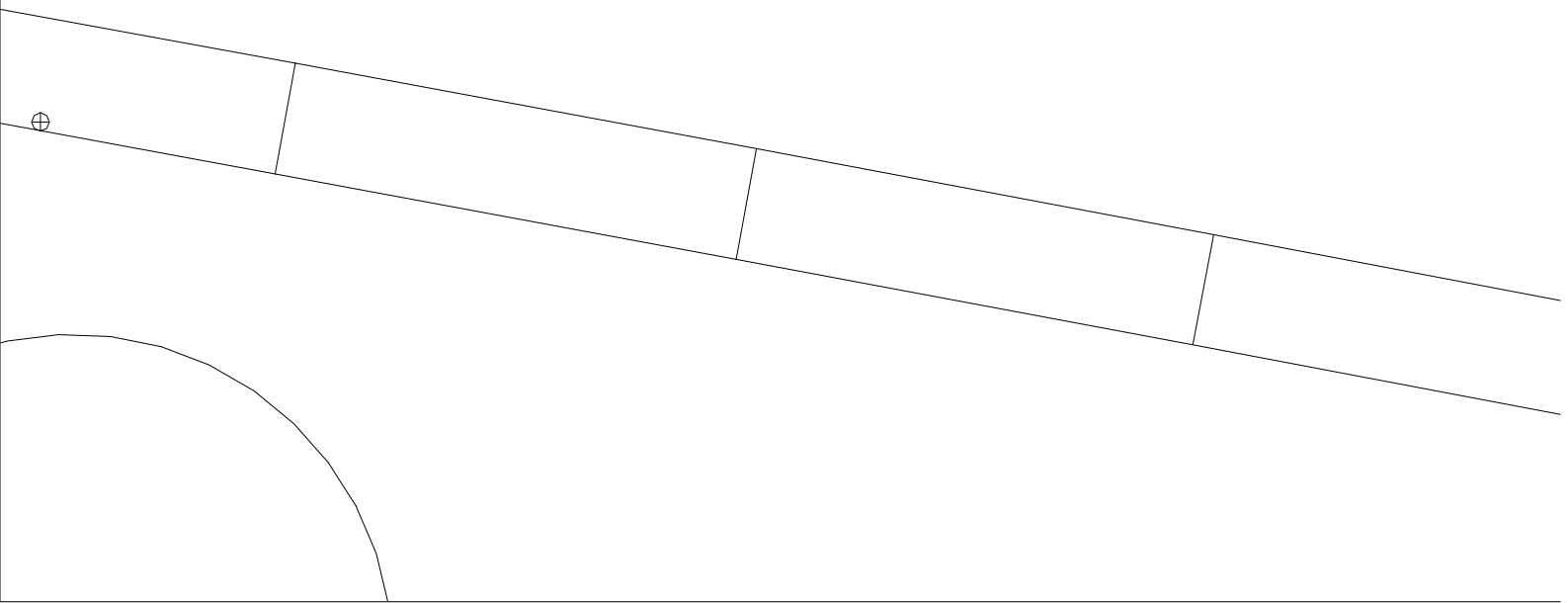

4-13

4-14

4-15

4-16



4-1

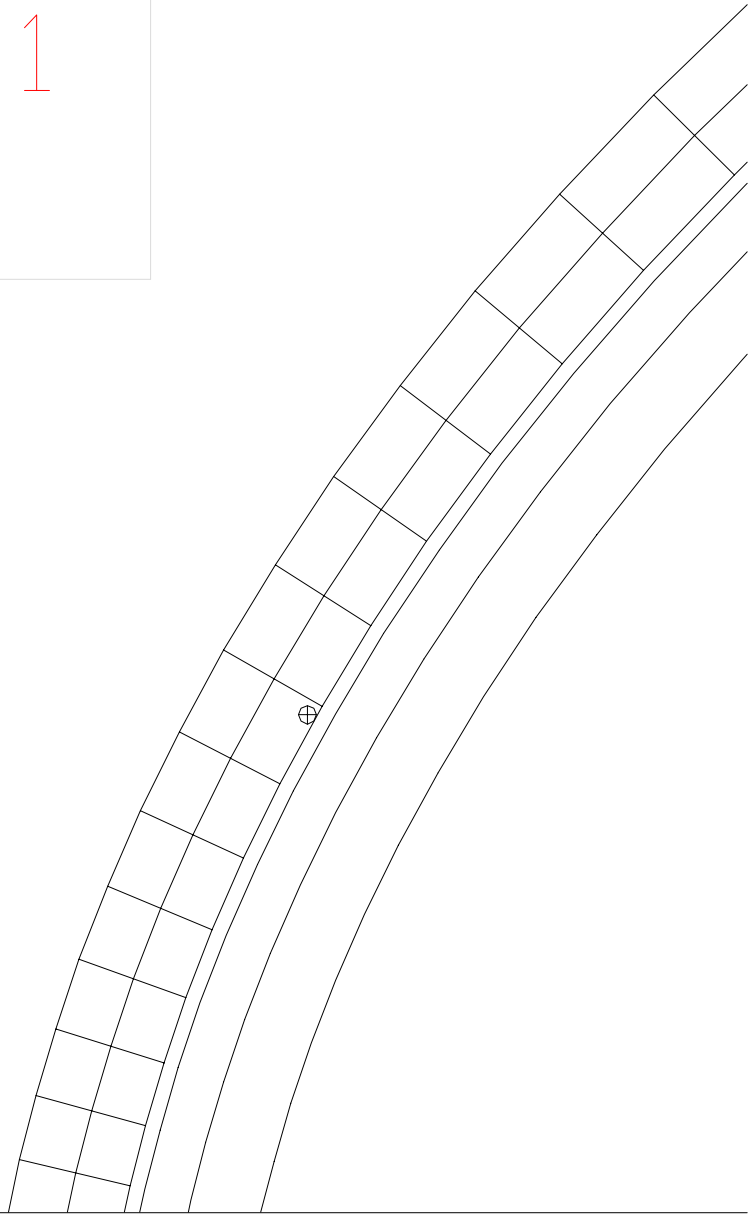

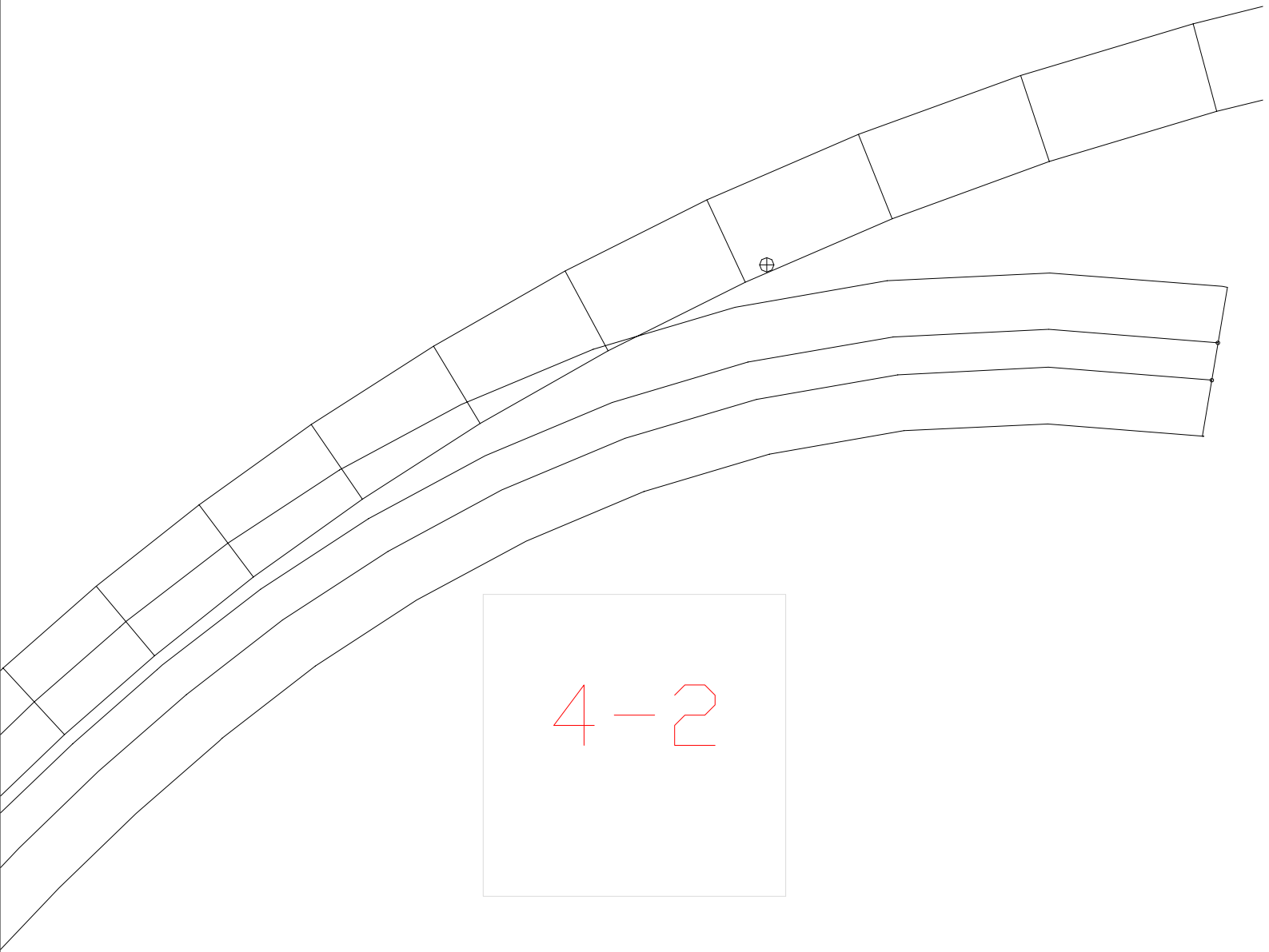

4-2

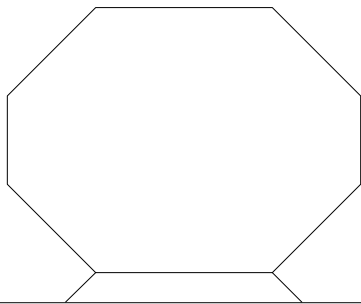

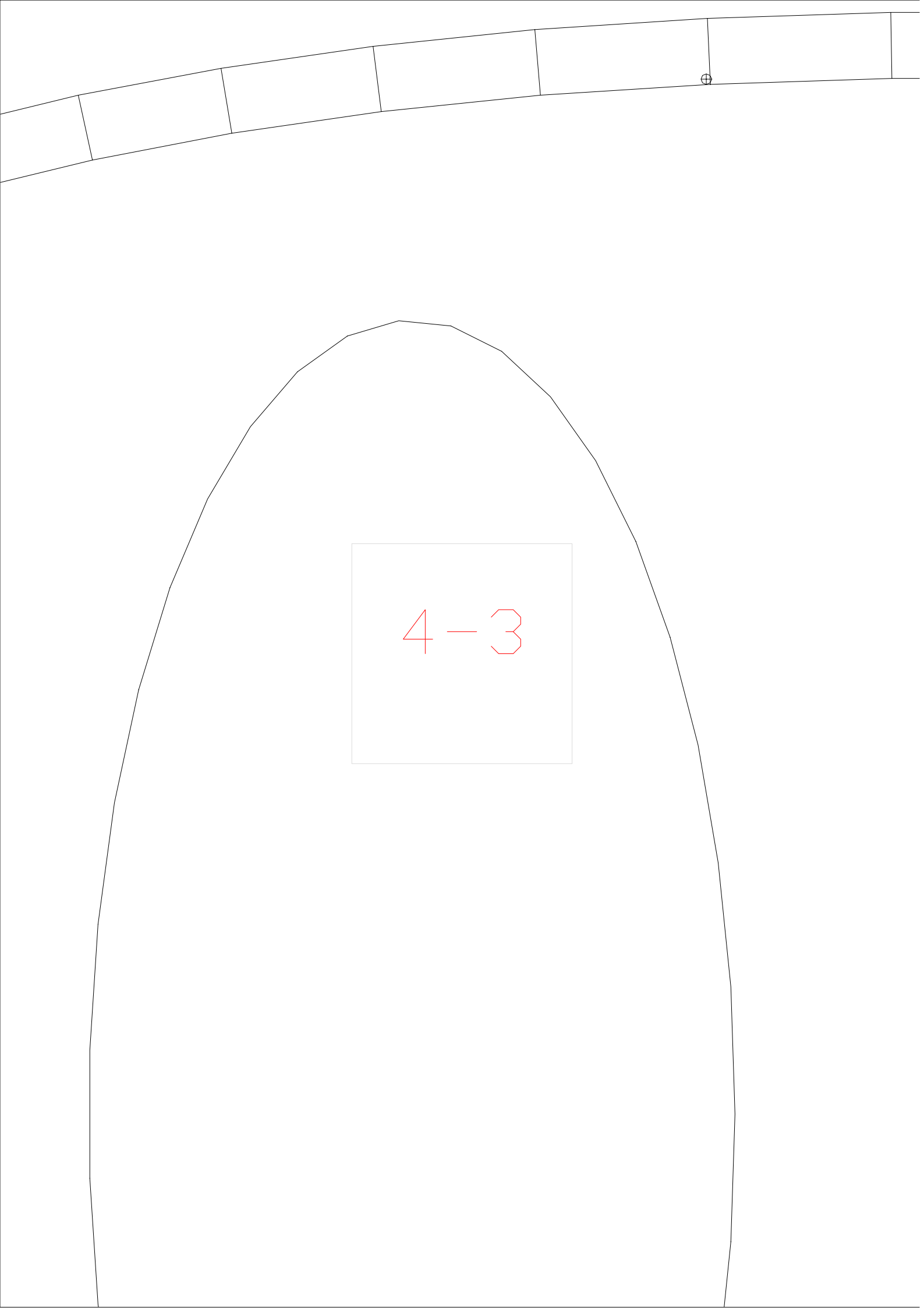

4-3

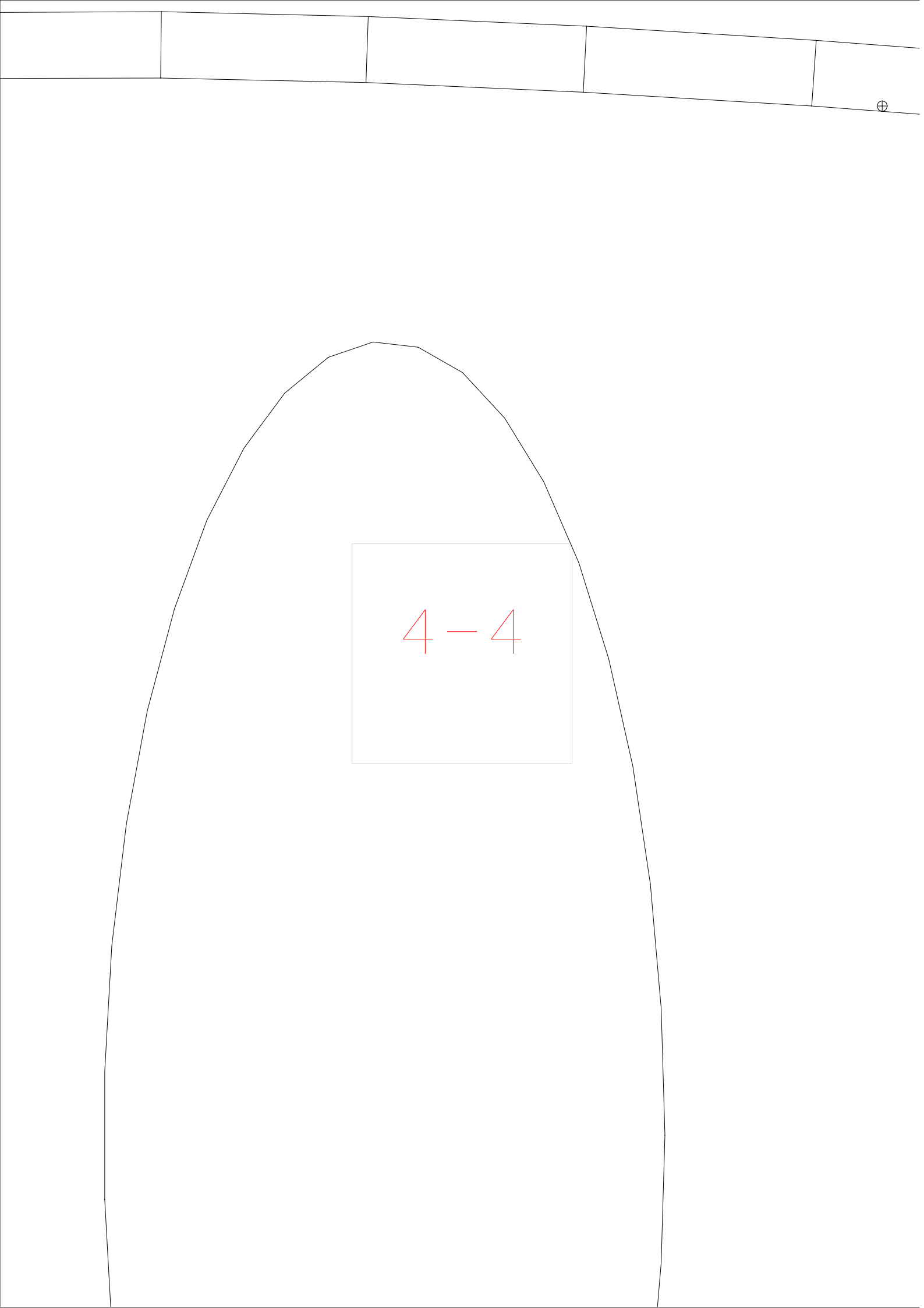

4-4

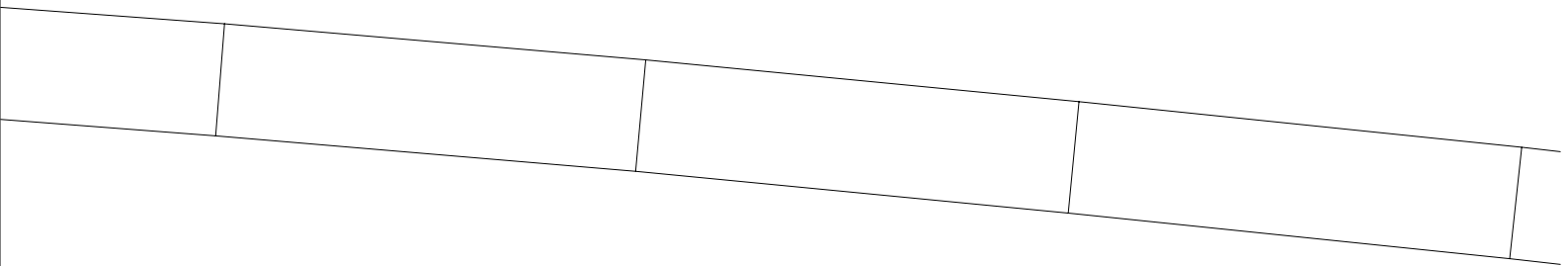

4-5

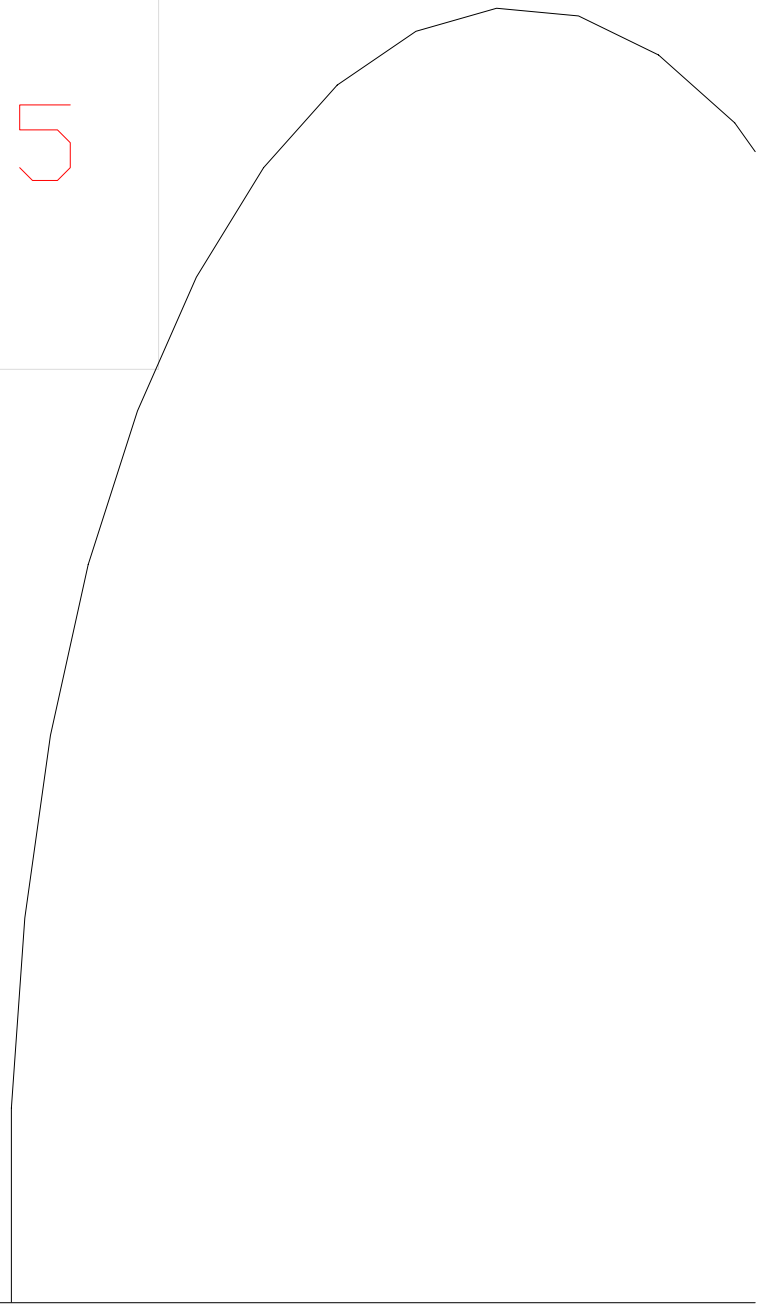

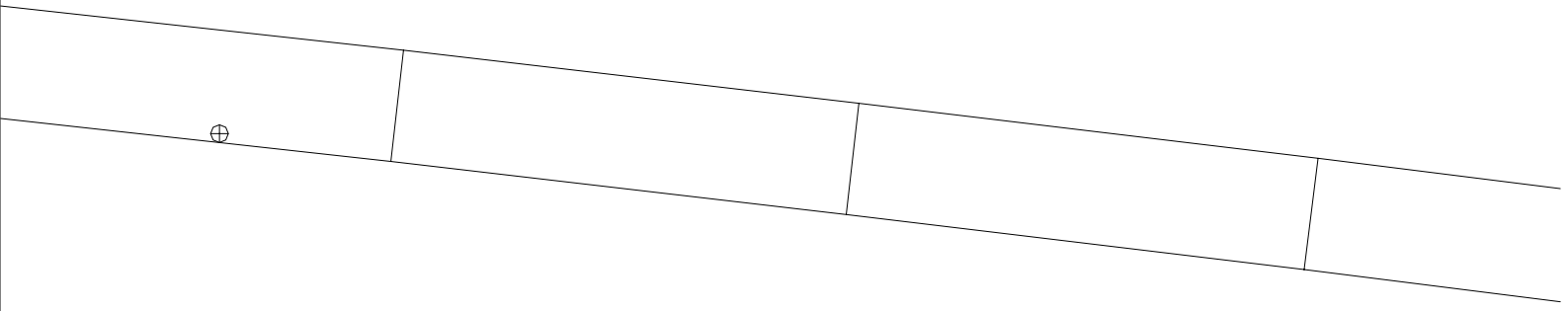

4-6

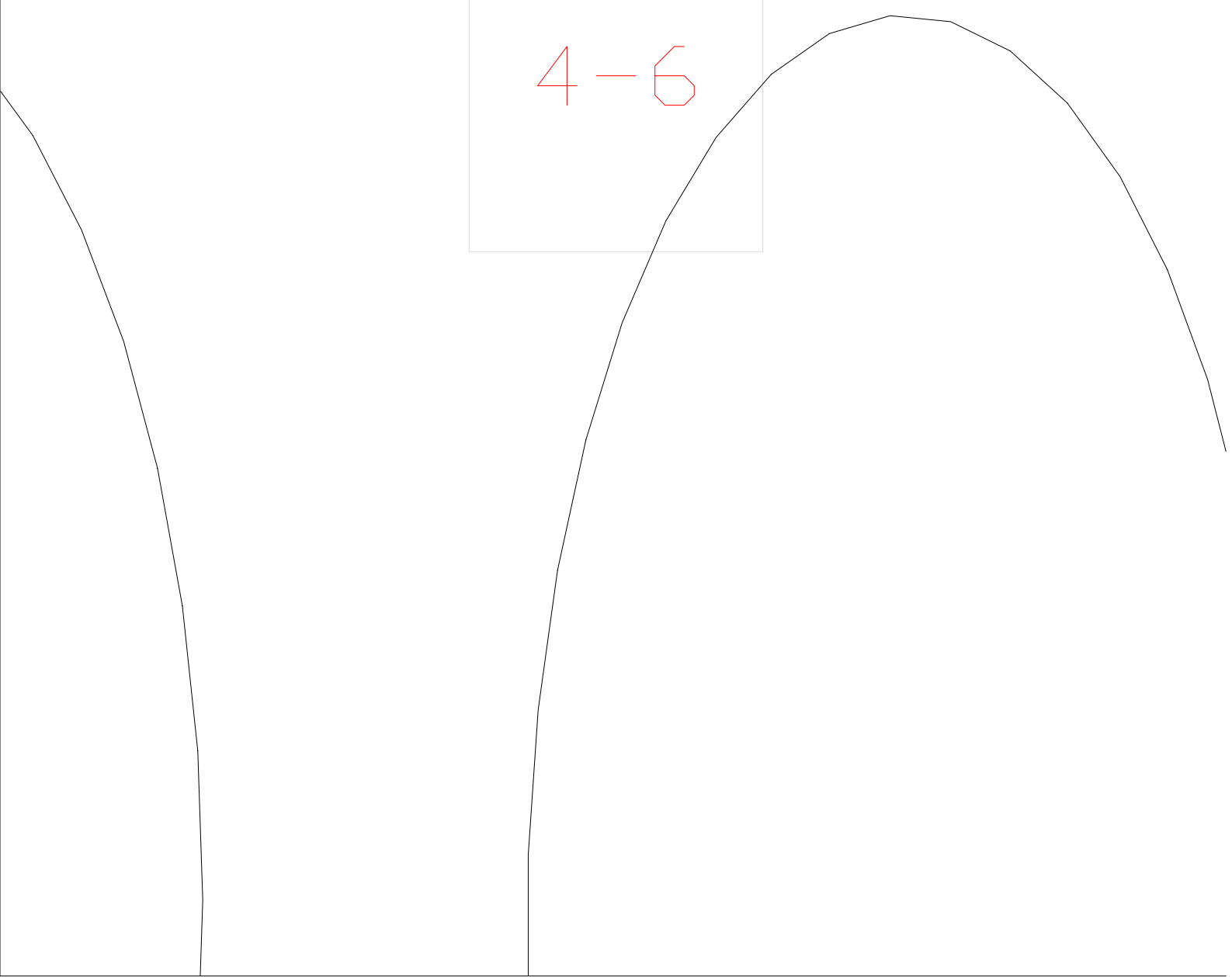

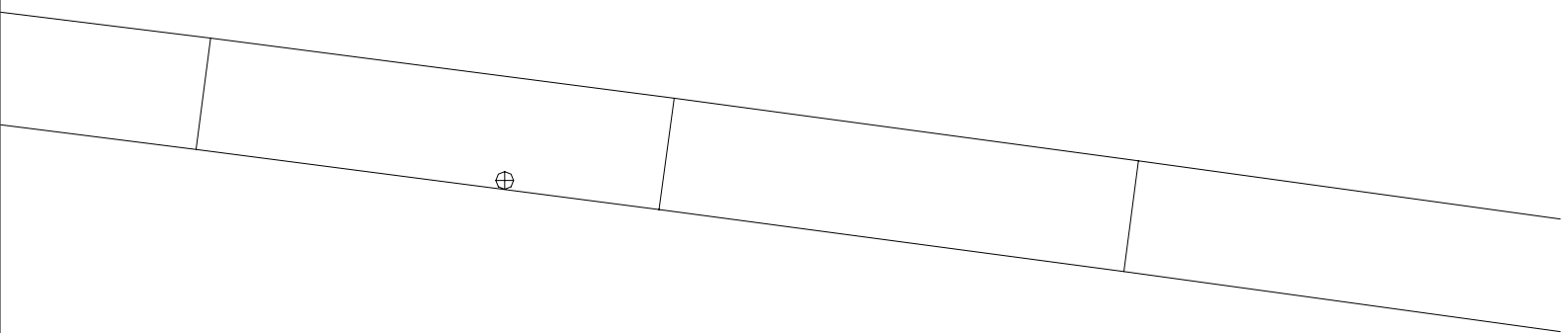

4-7

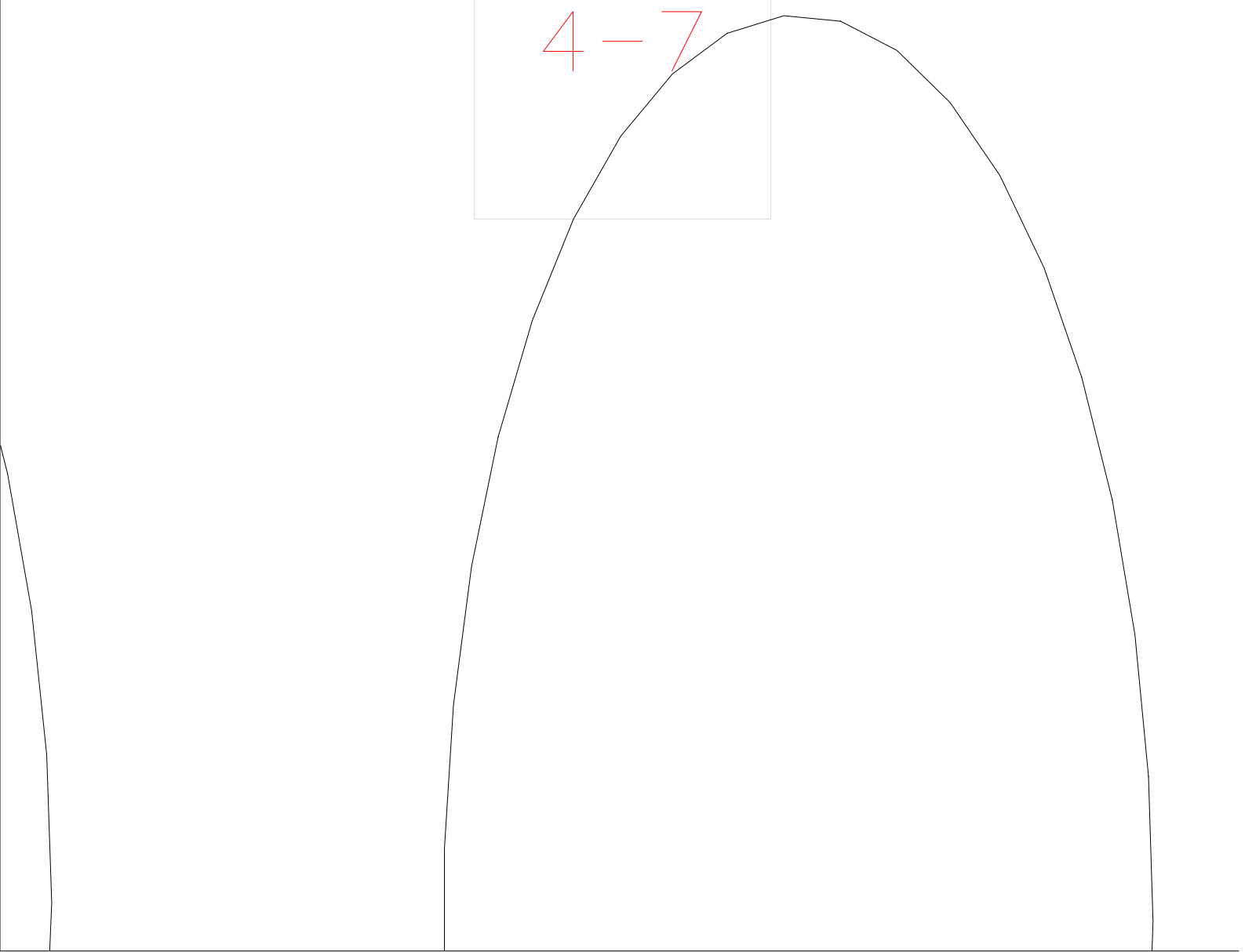

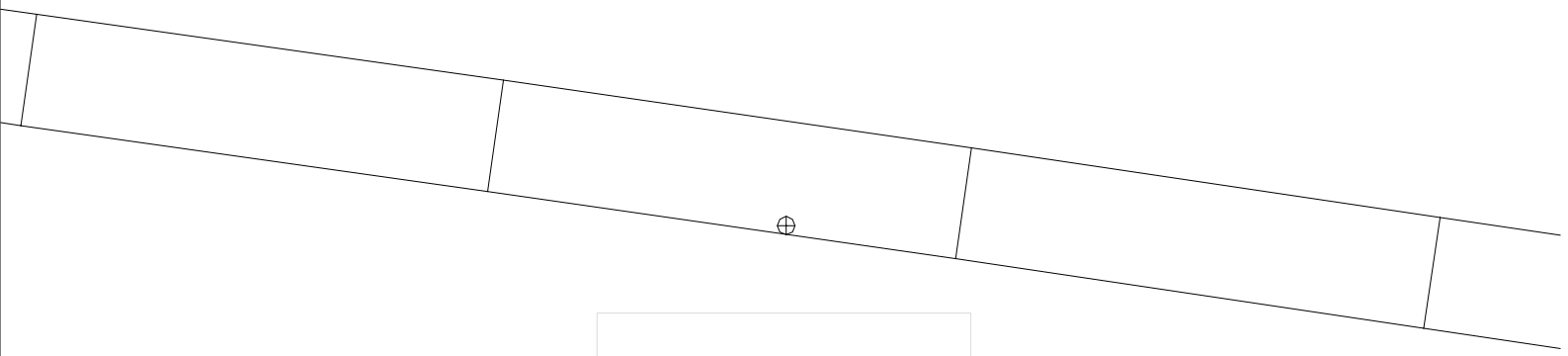

$$4 - 8$$

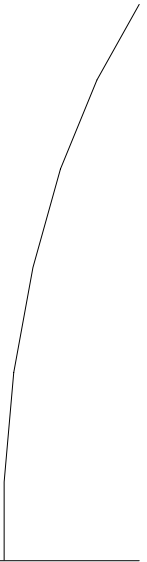



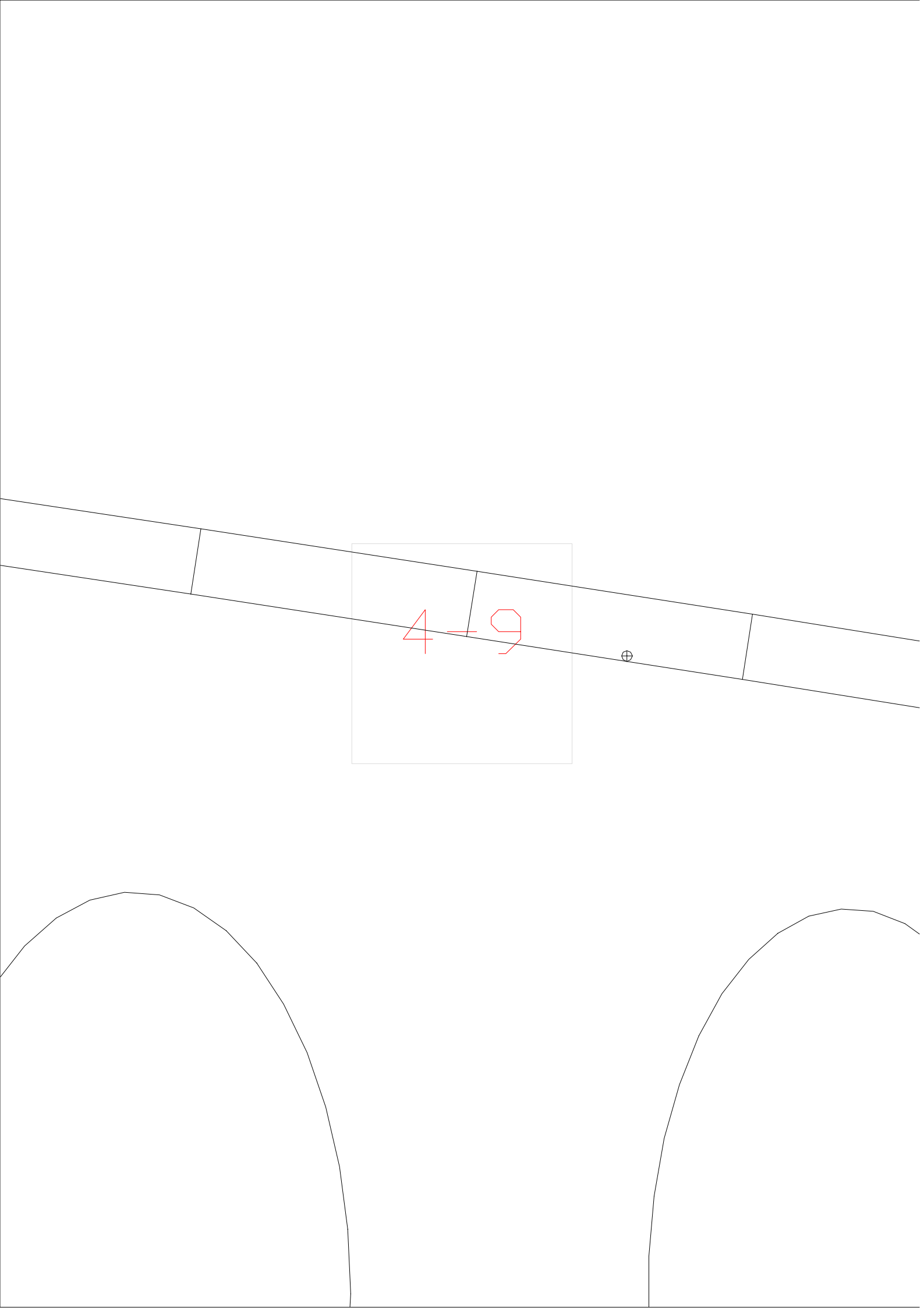

49

⊕

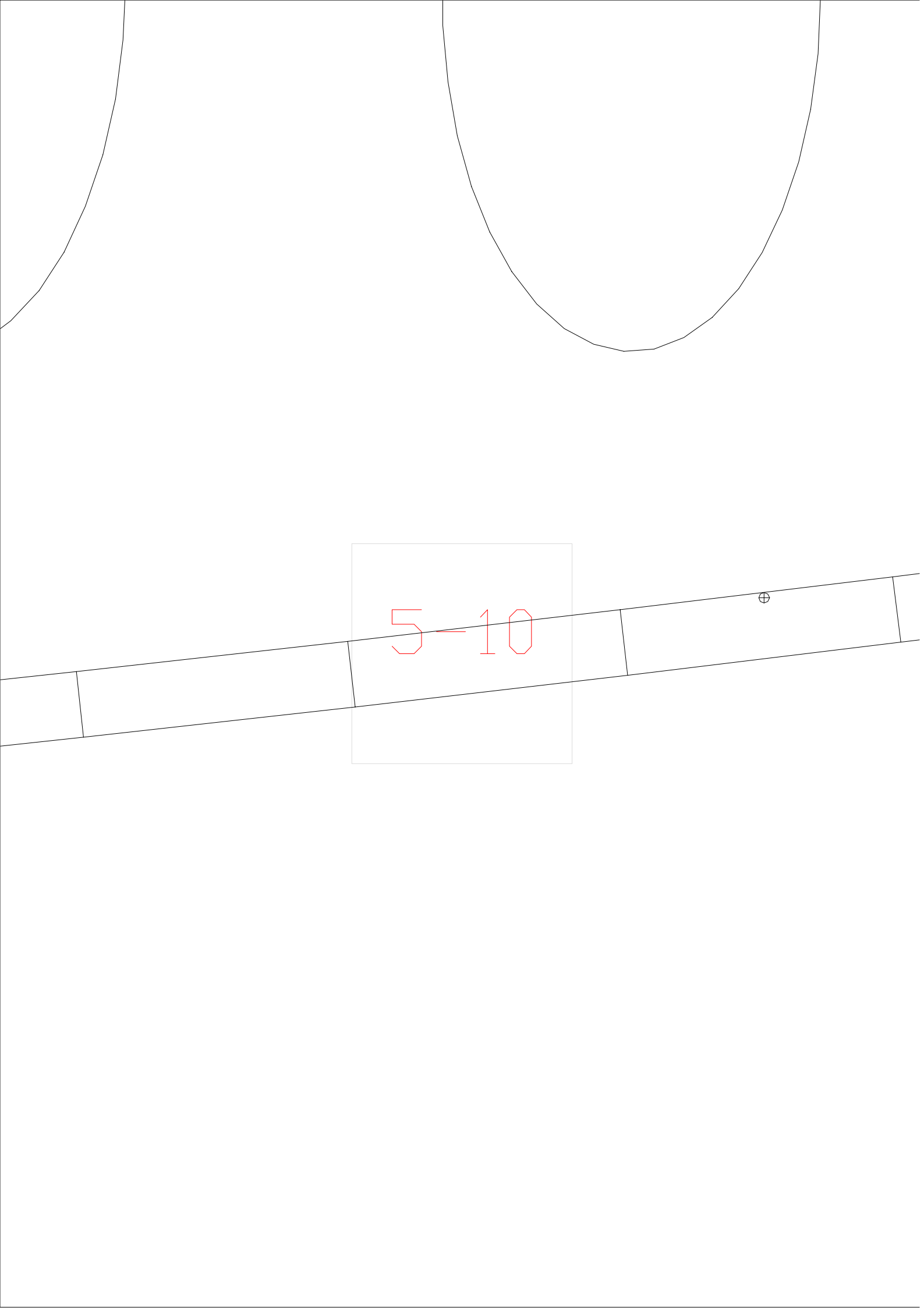

5-10



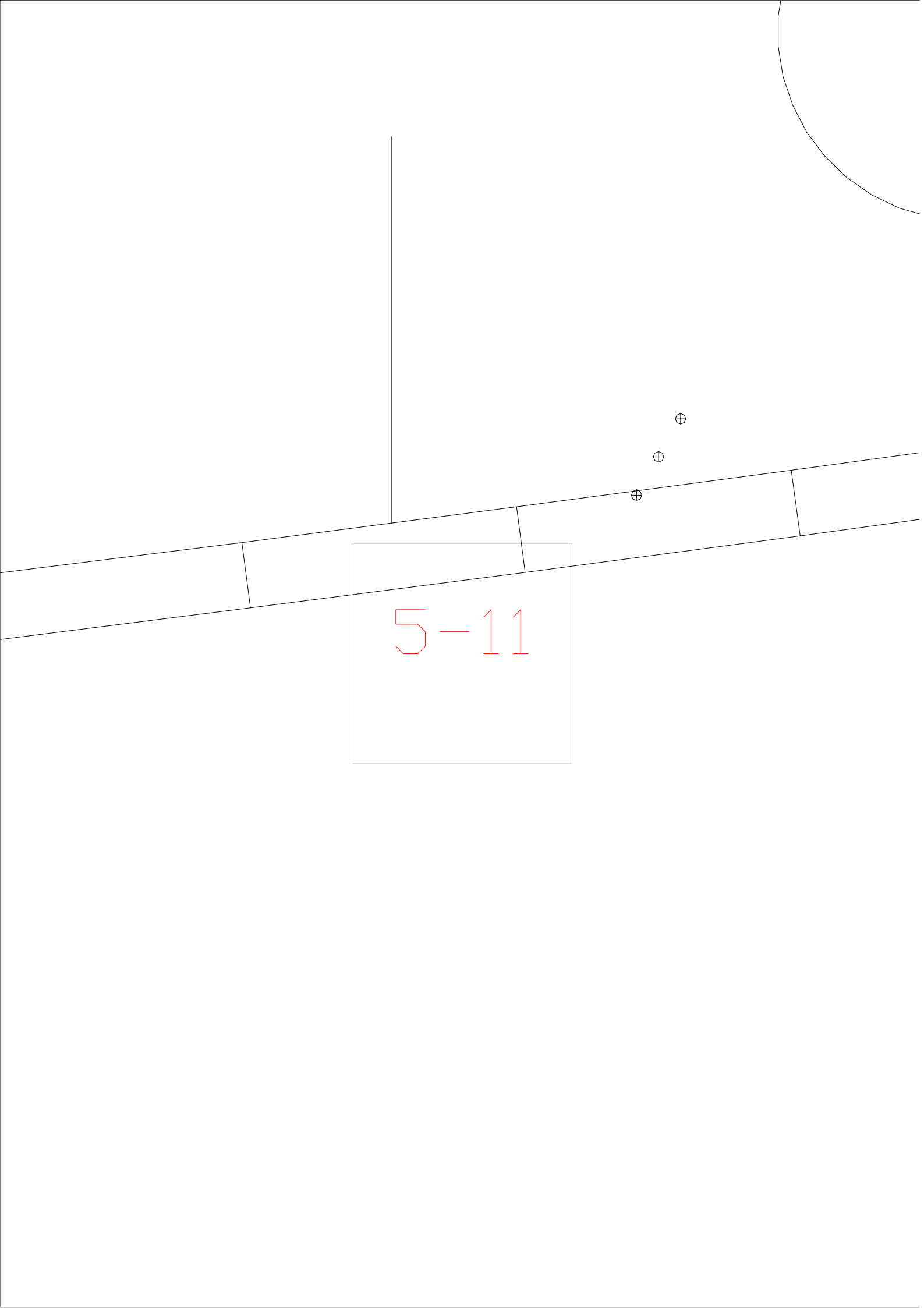

5-11

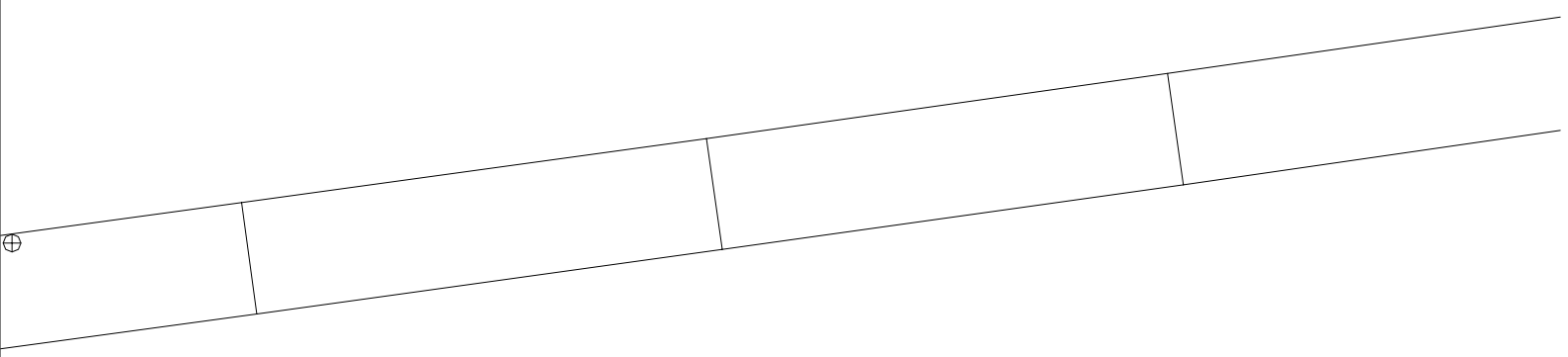
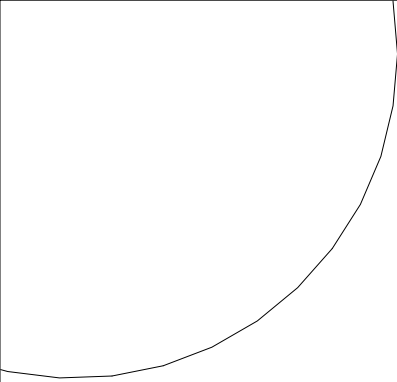

5-12

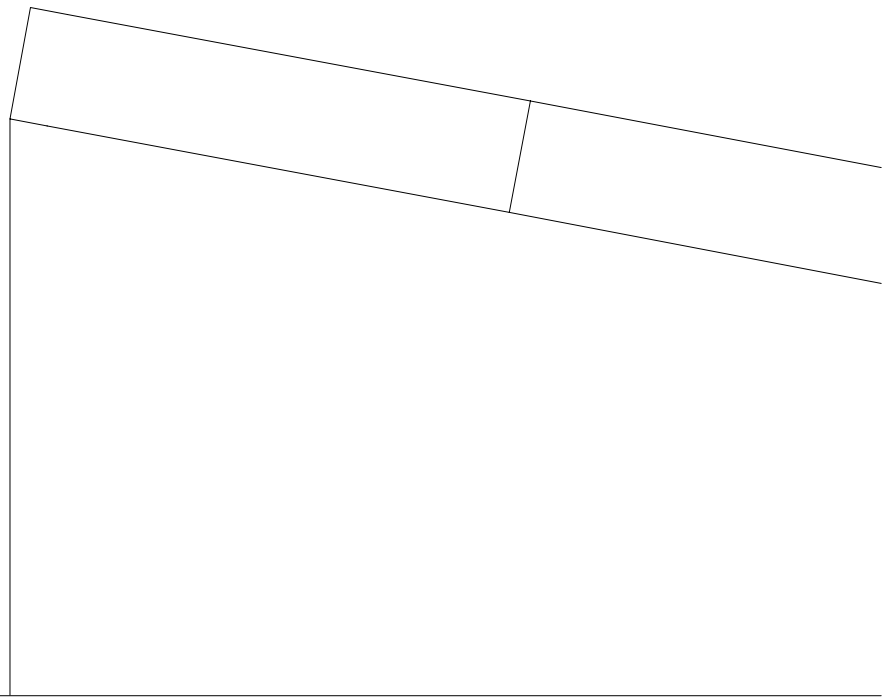

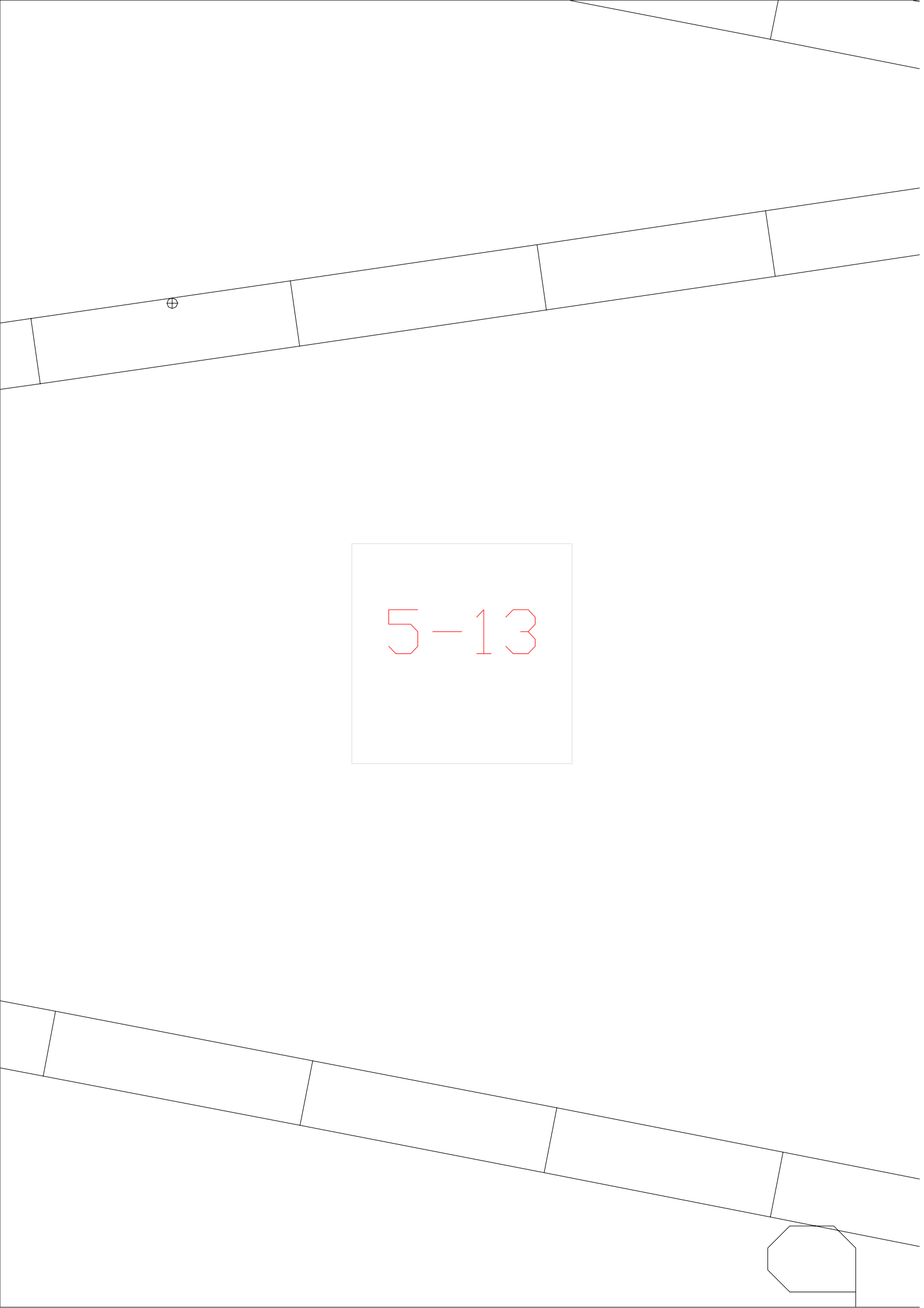

5-13

The image shows a technical drawing of a curved structure, possibly a pipe or duct, with a central rectangular label containing the text '5-13'. The structure is divided into several segments by vertical lines. A small circle with a cross inside is located on the upper left segment. The drawing is a line drawing with no shading or color.

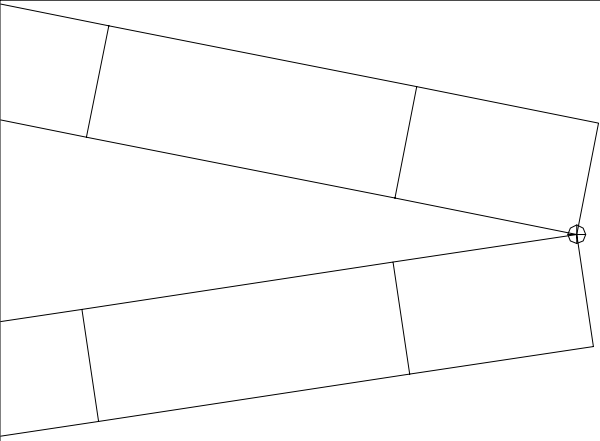

5-14

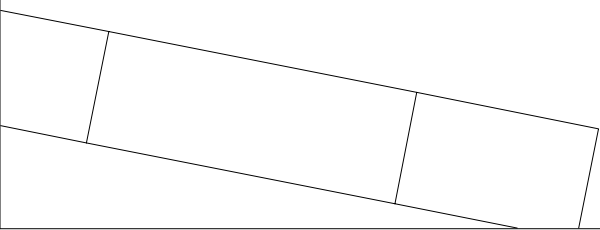

5-15

5-16



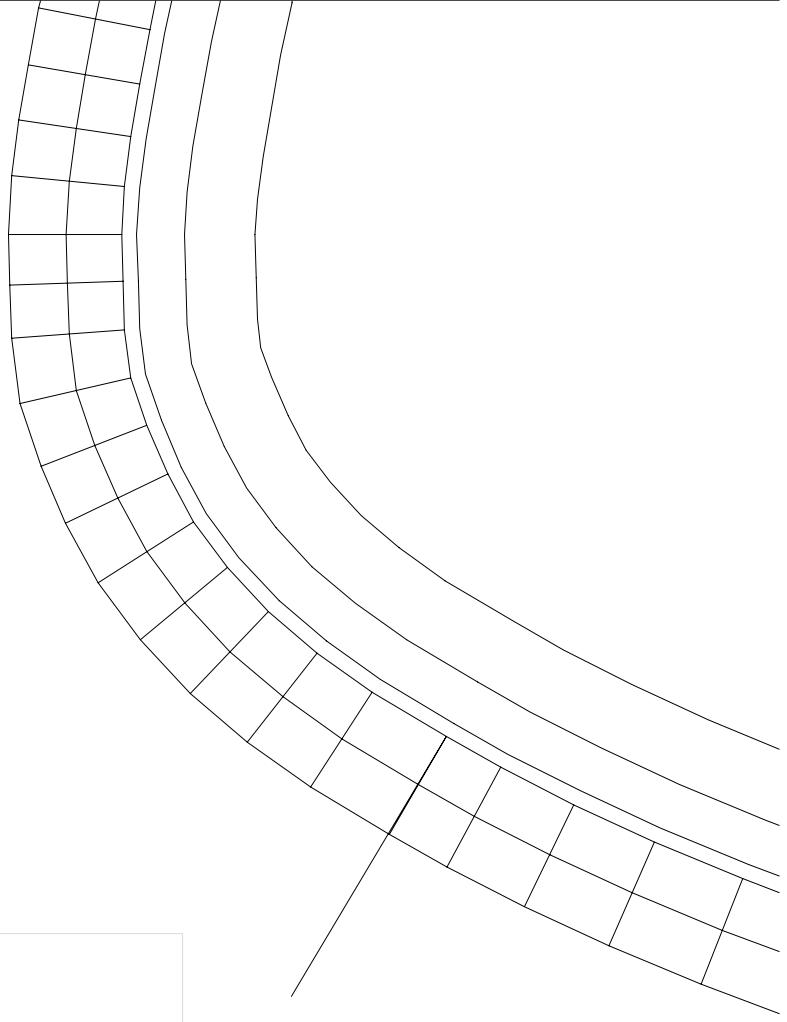

5-1

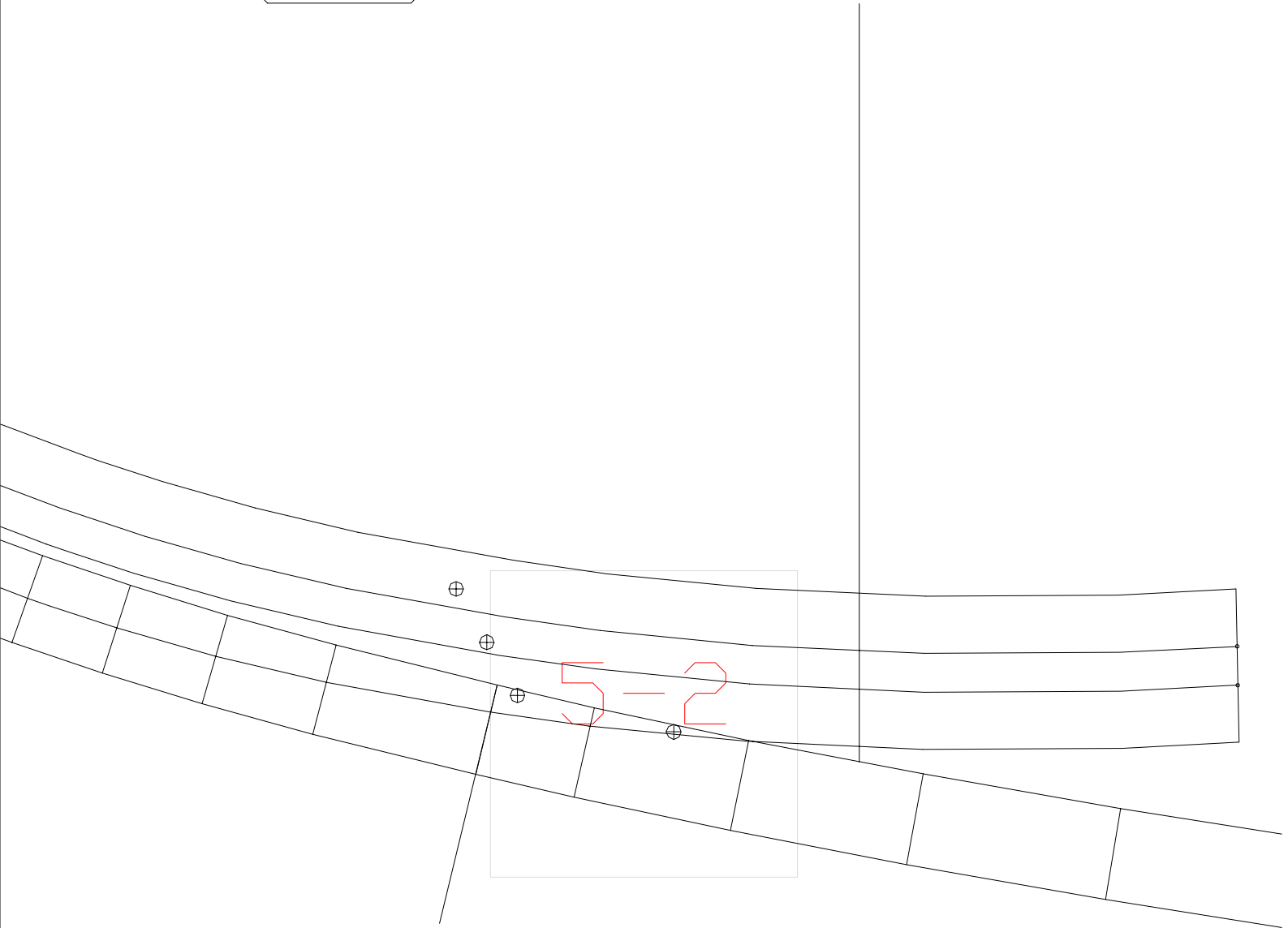
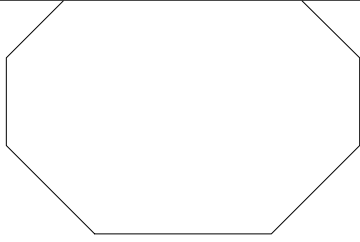

5-3

⊕

5-4

⊕

5-5

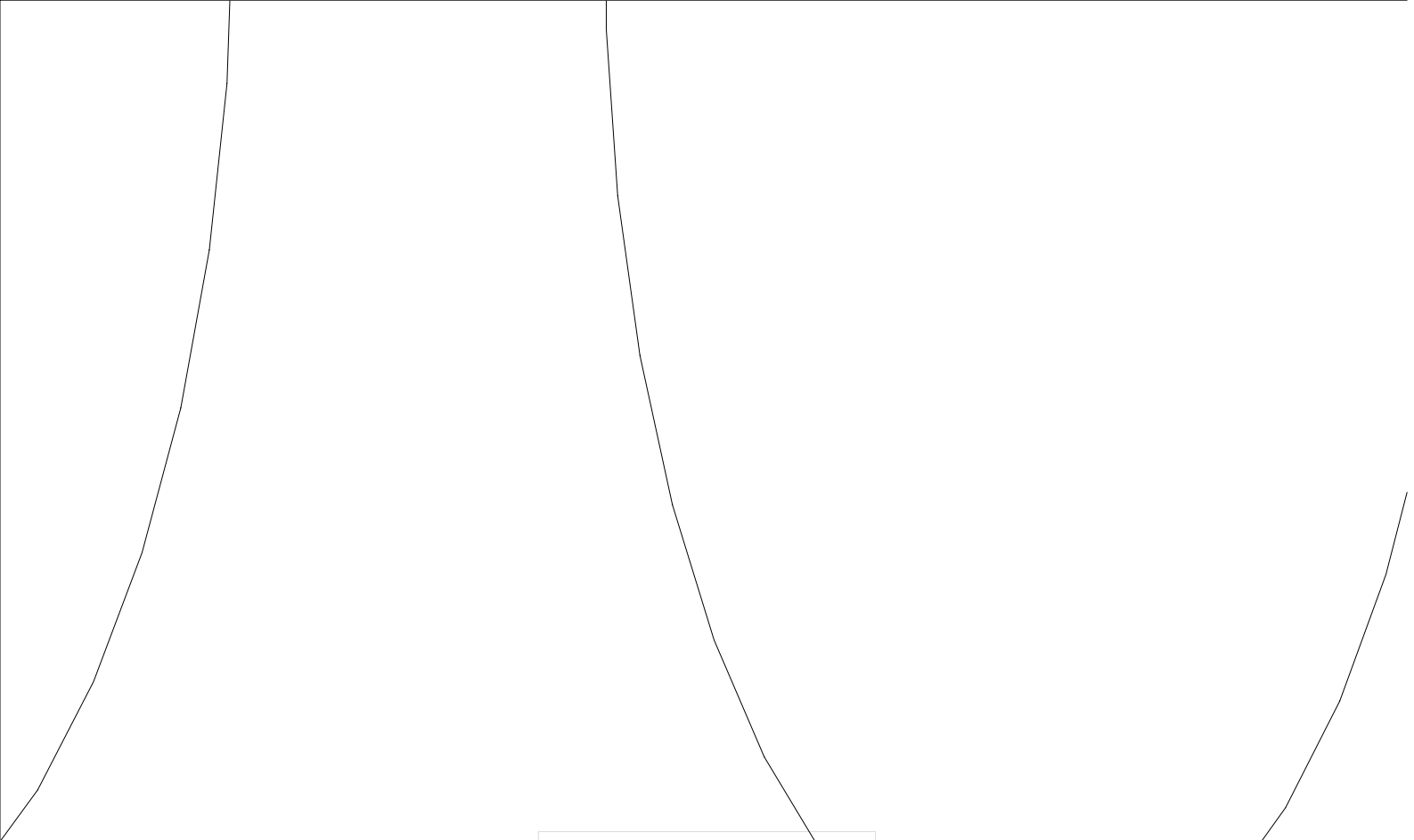

5-6

⊕			
---	--	--	--

5-7

	⊕		
--	---	--	--

5-8

⊕



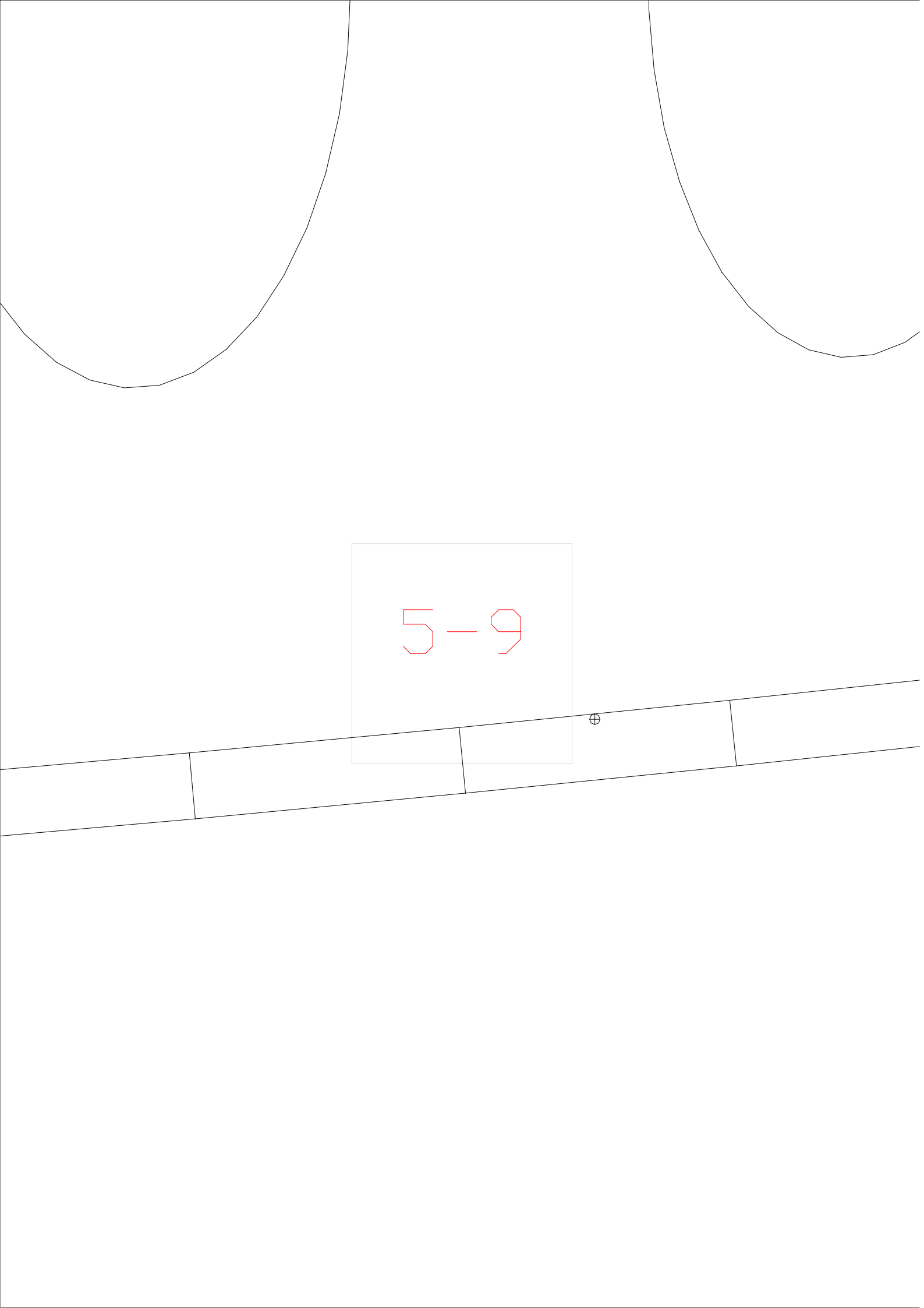

5-9

6-10

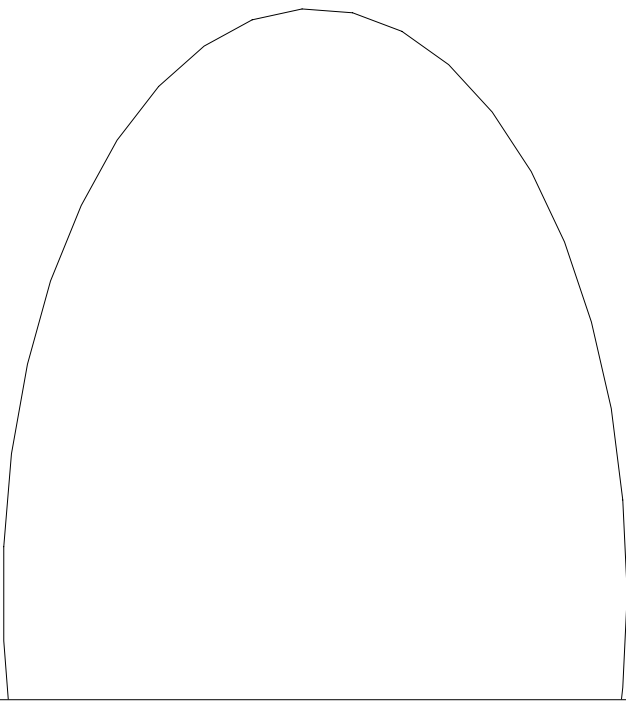

6-11

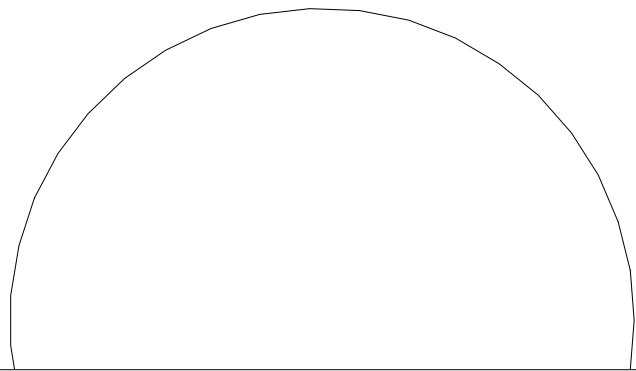
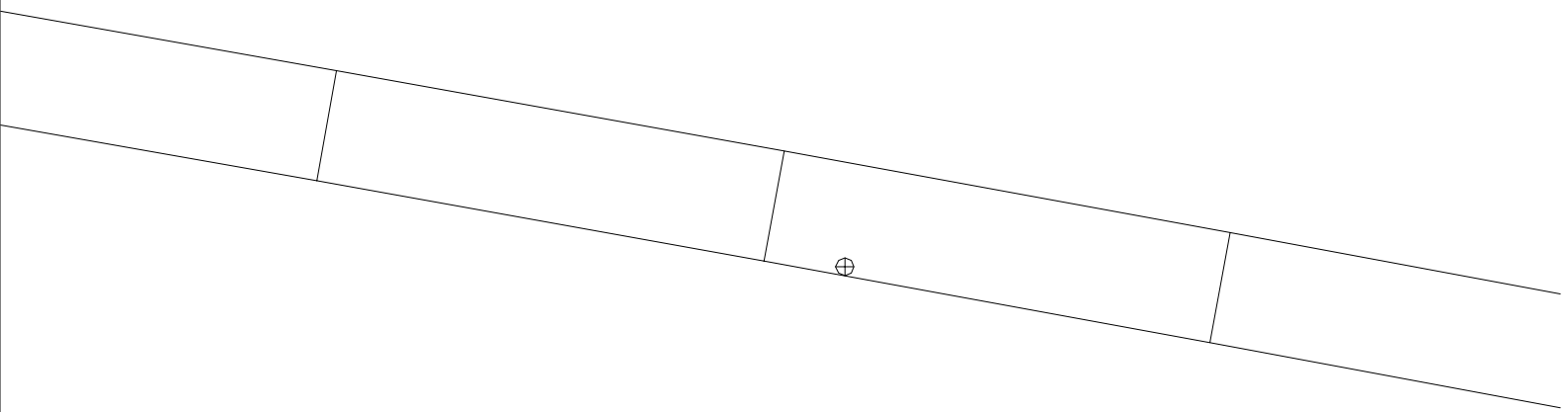

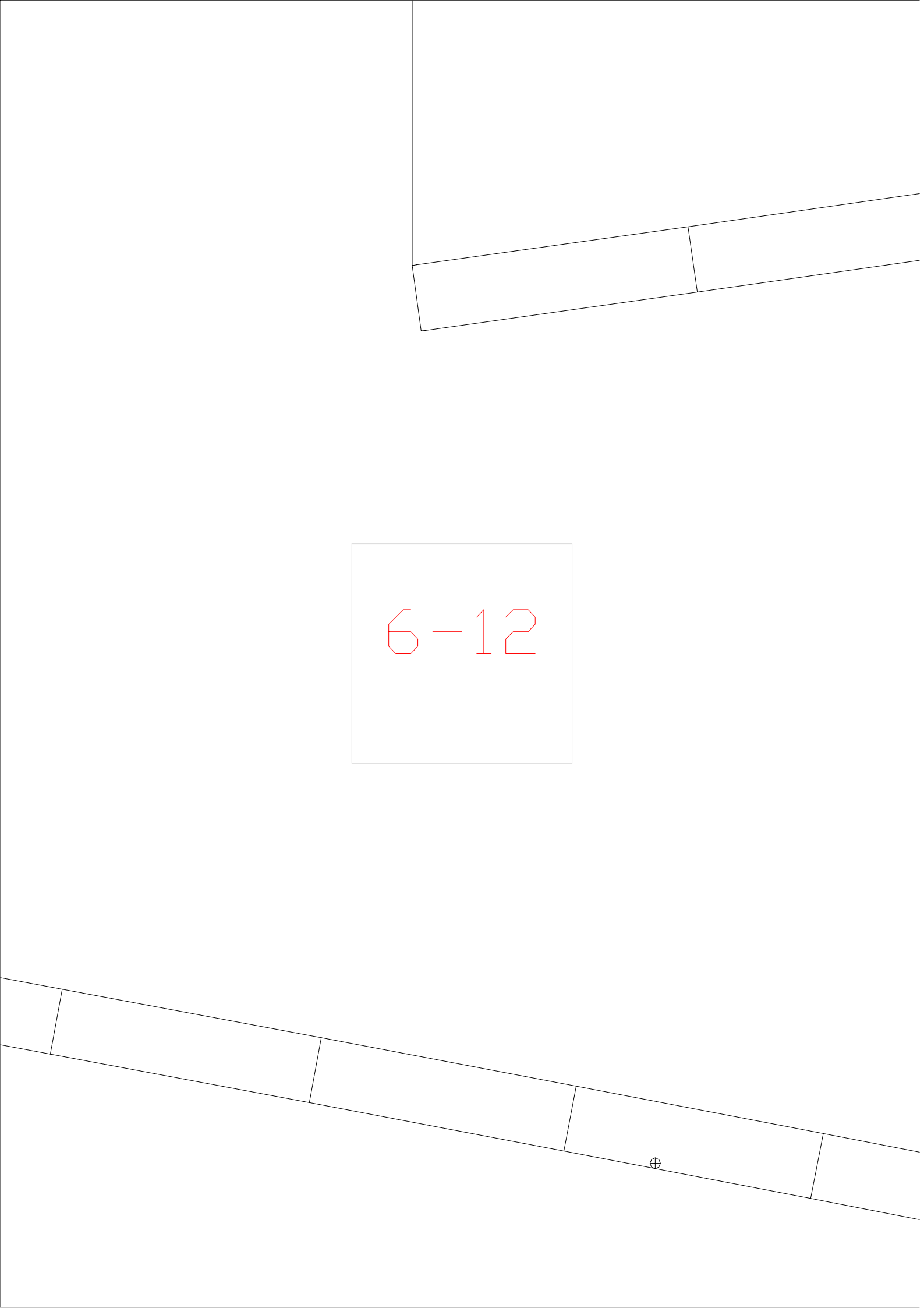

6-12

The image shows a technical drawing of a tapered shaft. The shaft is oriented diagonally from the top right to the bottom left. It is divided into four segments by three vertical lines. The central segment is the largest. In the center of the shaft, there is a rectangular box containing the text '6-12' in red. The shaft tapers from a larger diameter at the top right to a smaller diameter at the bottom left. A small circle with a cross inside is located on the lower part of the shaft.

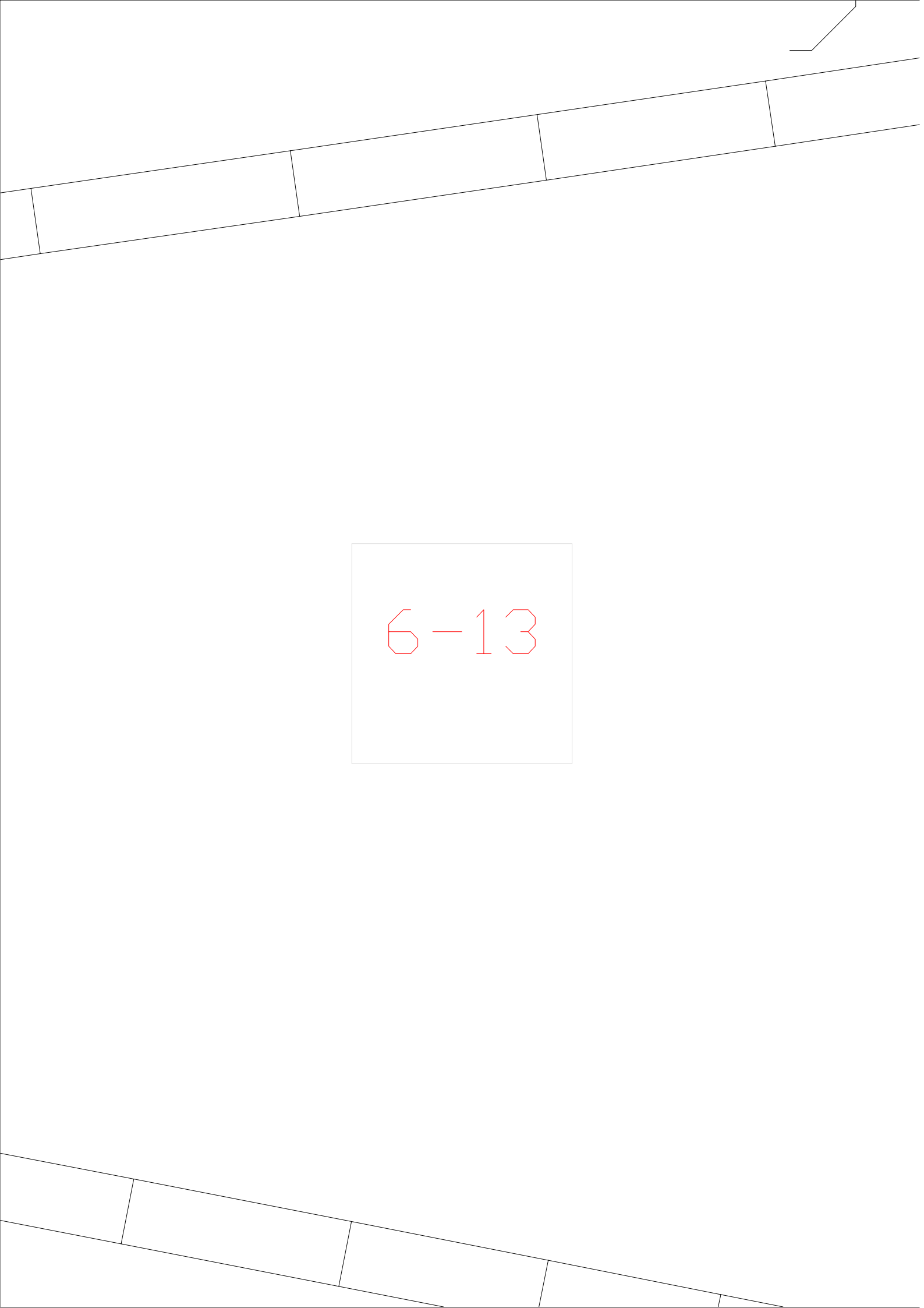

6-13

--	--	--

6-14

6-15

6-16



6-1

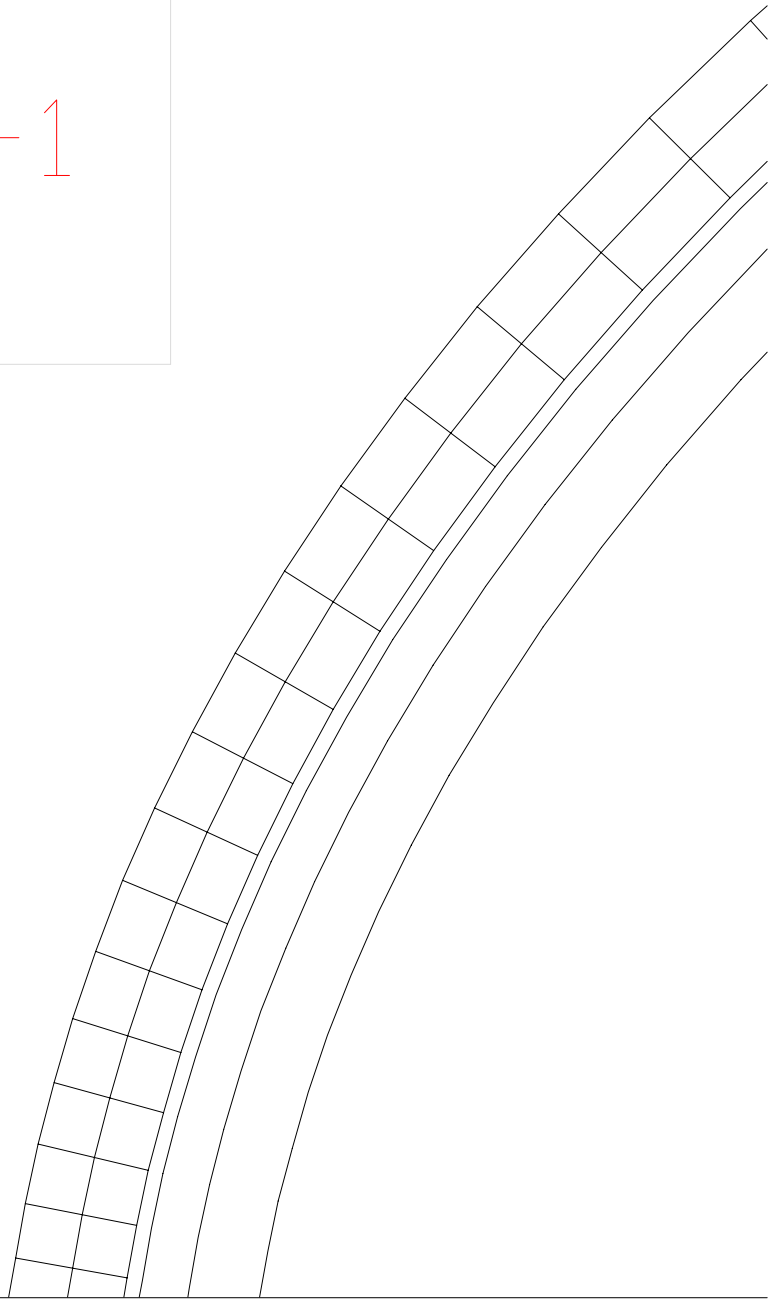

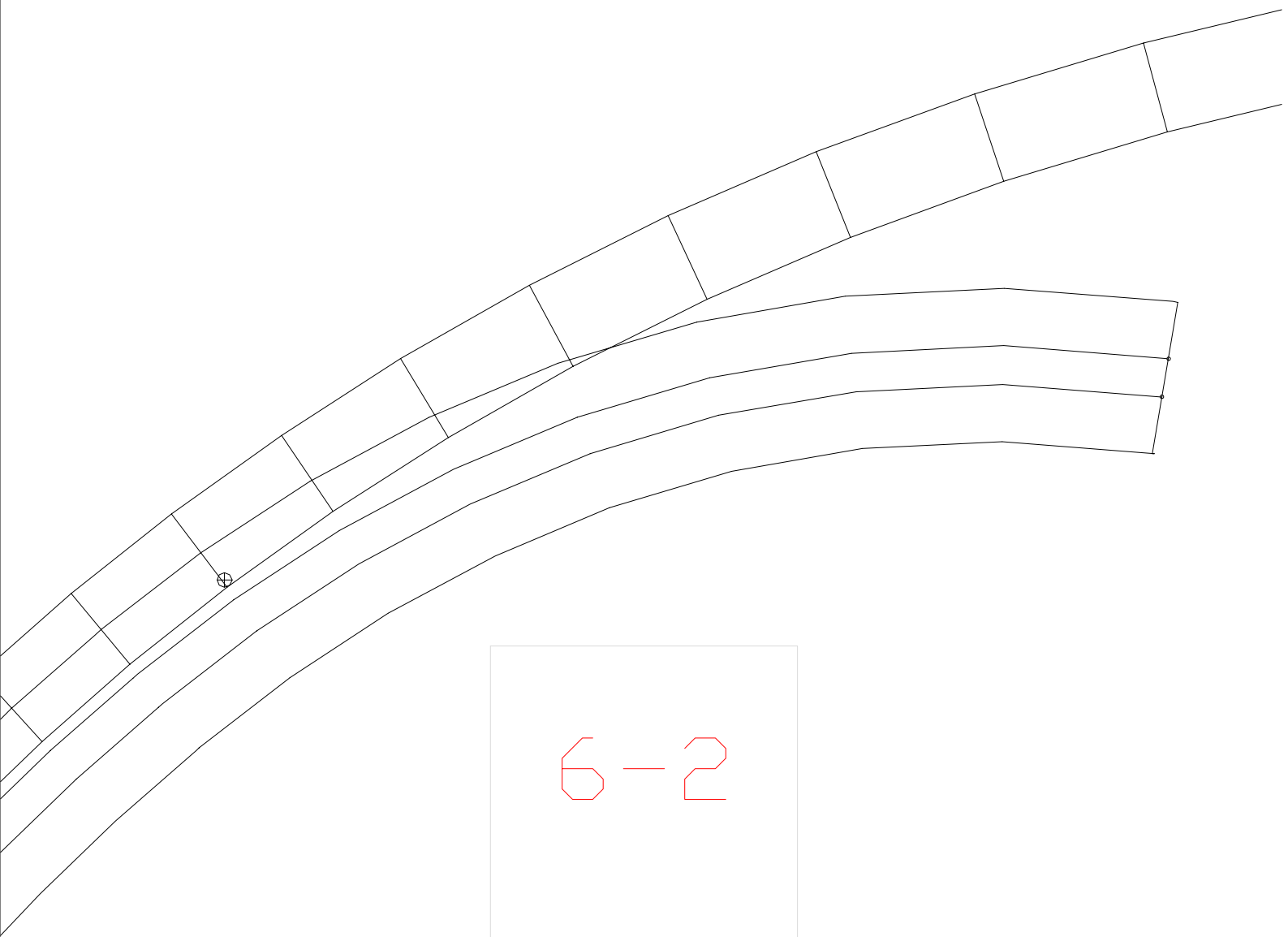

6-2

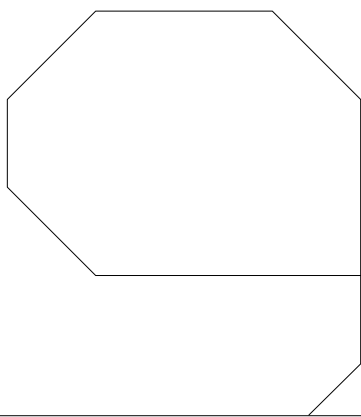

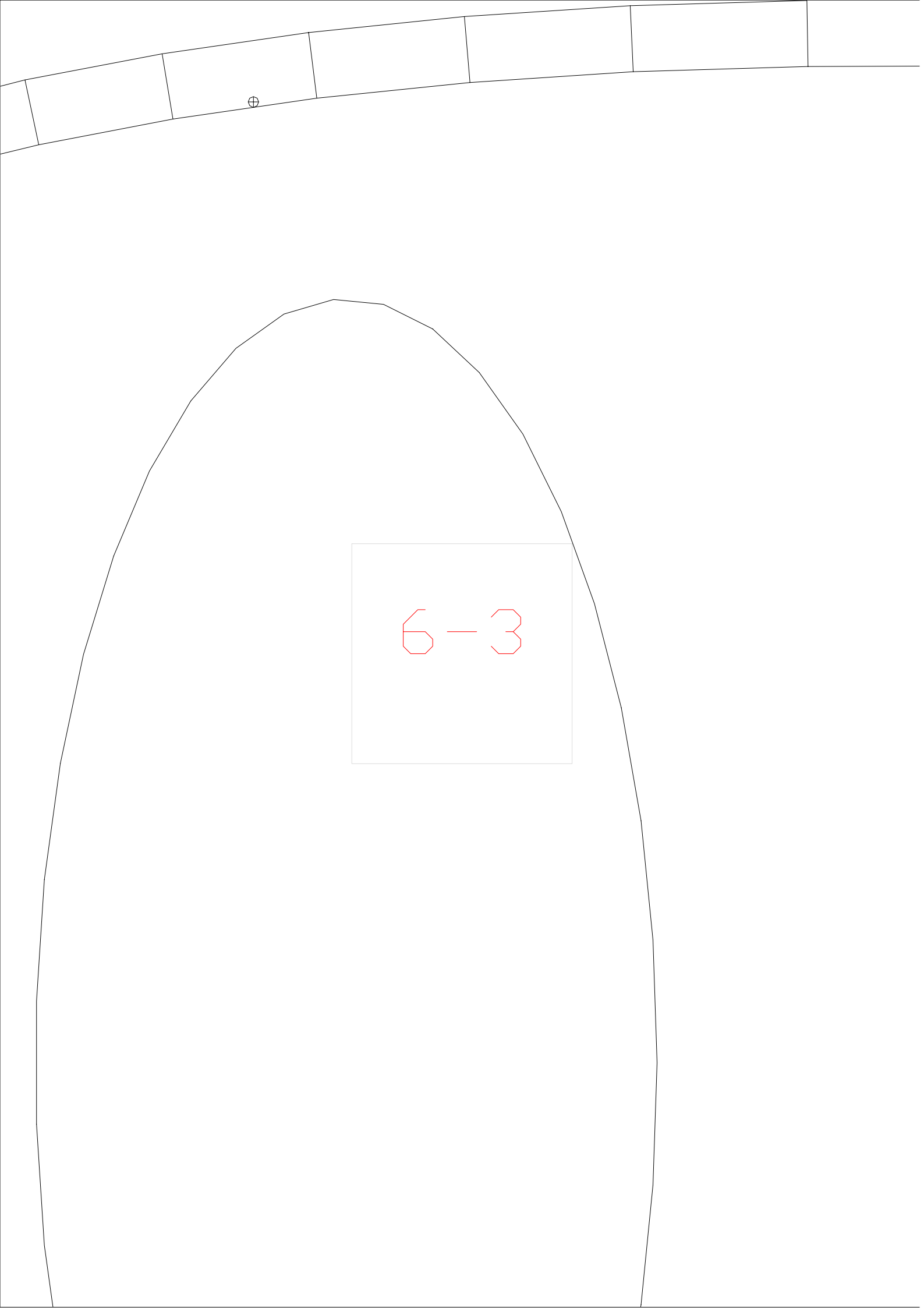

6-3

⊕

6-4

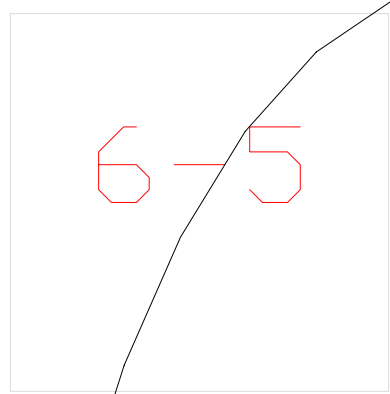
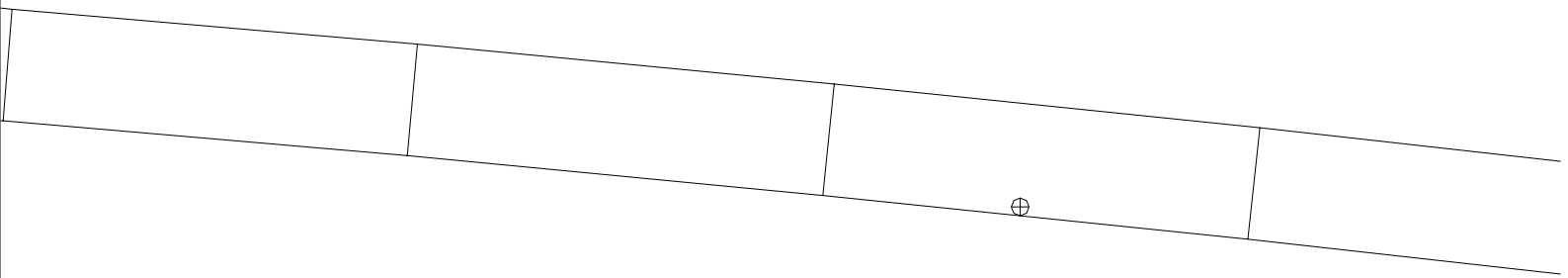

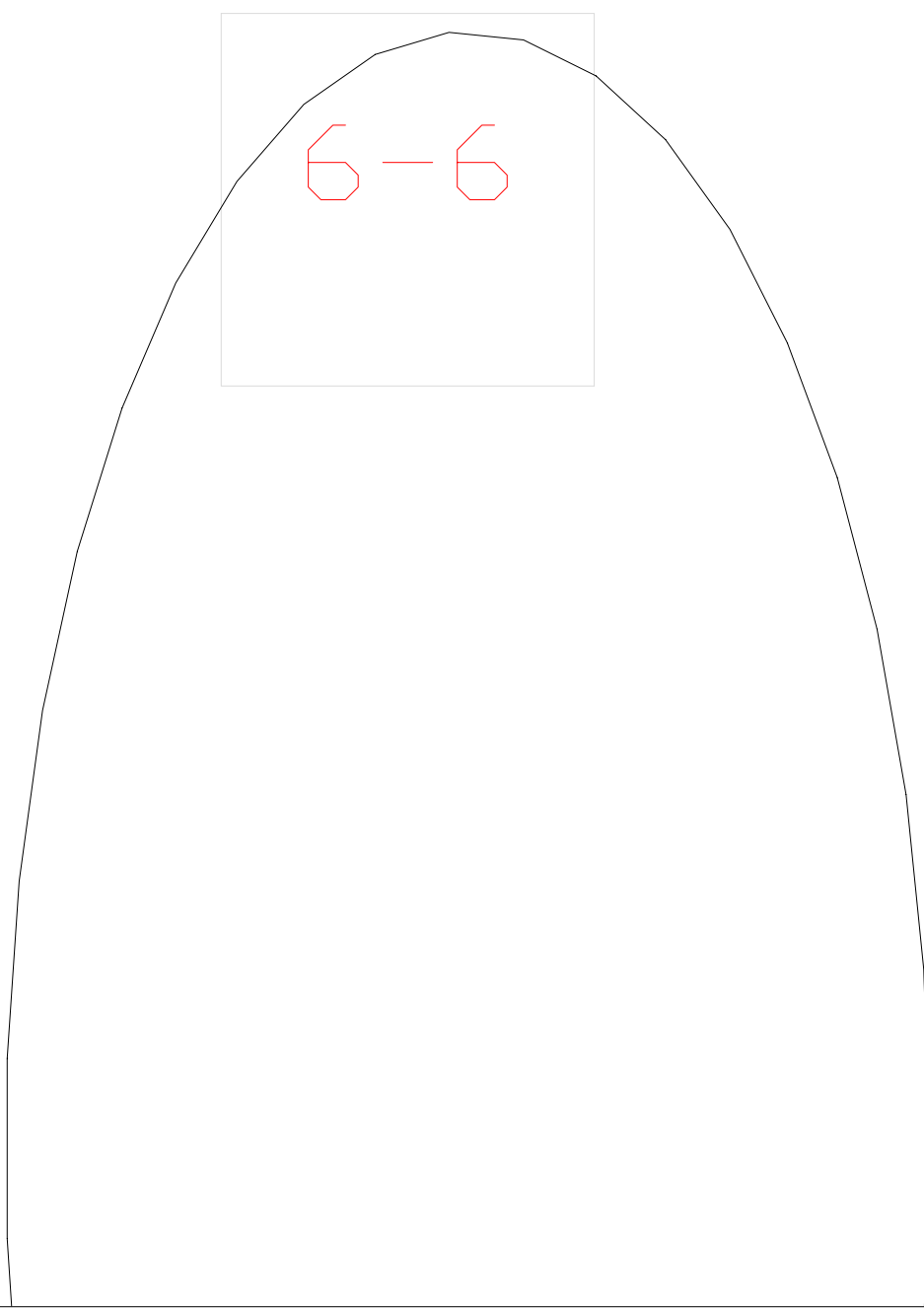
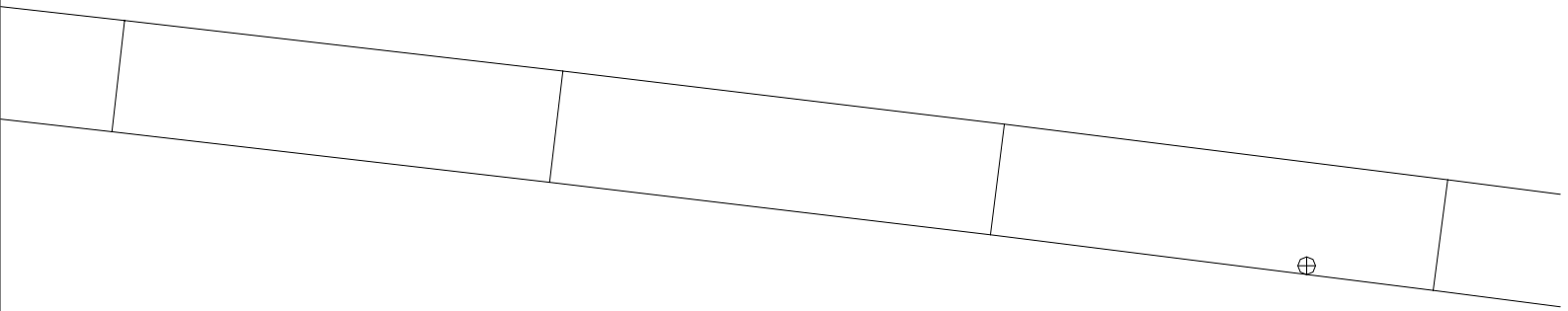

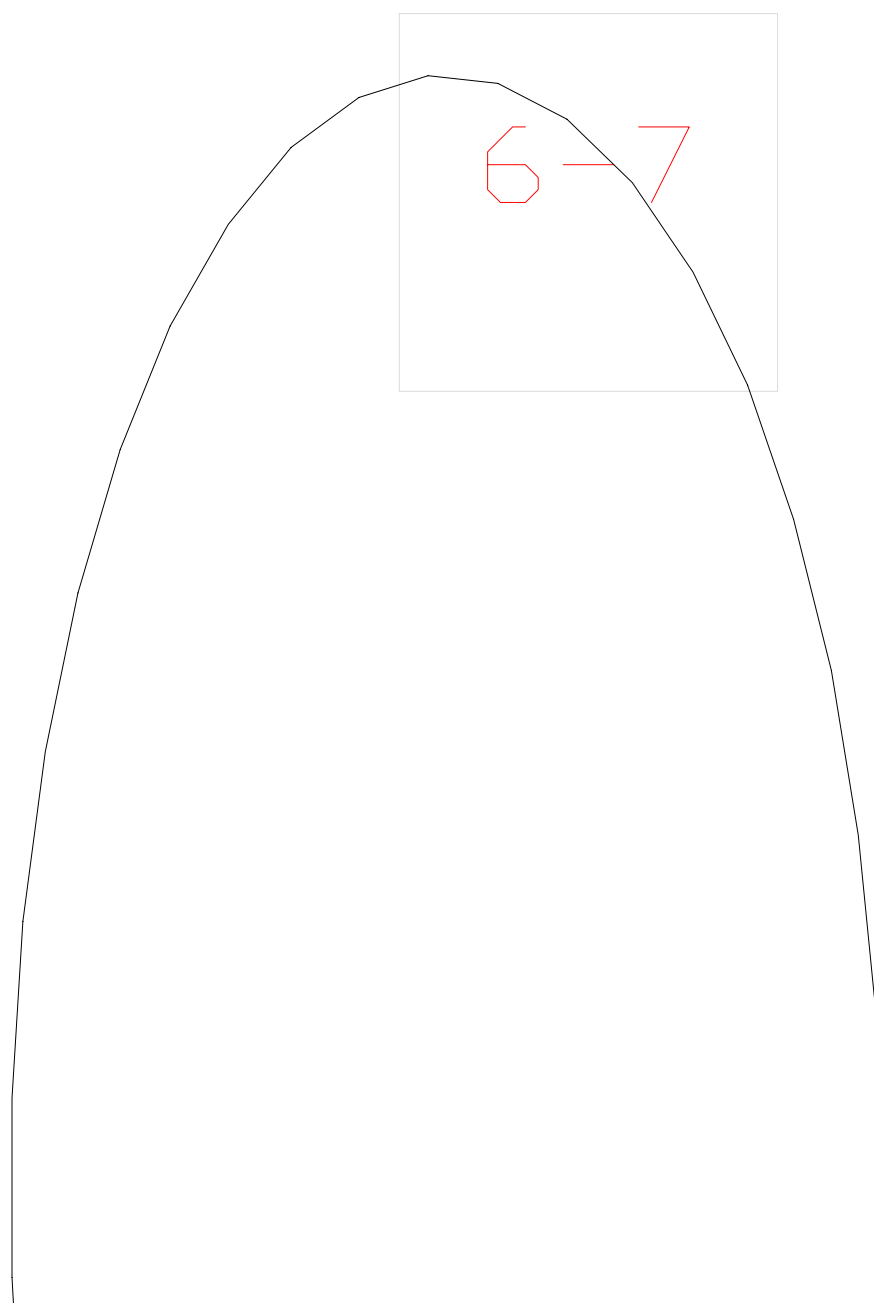
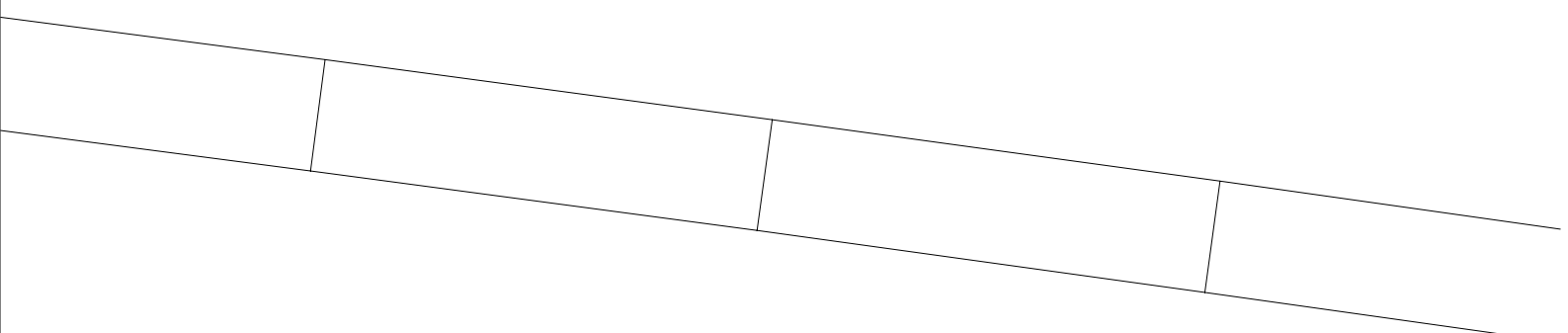

6-7

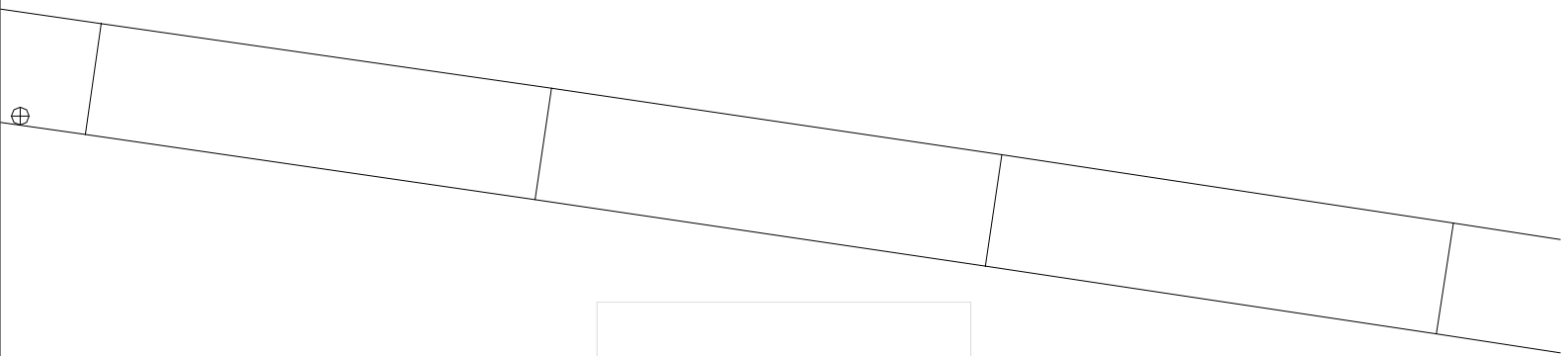

6-8

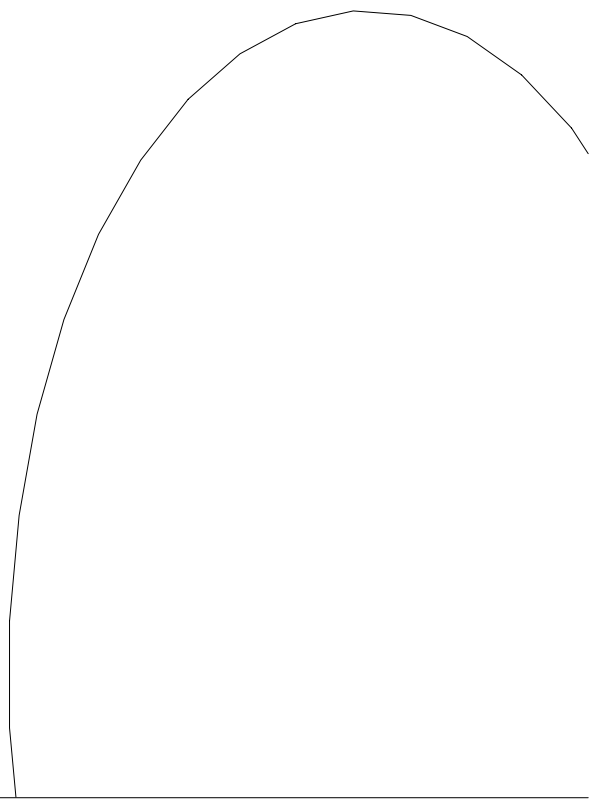



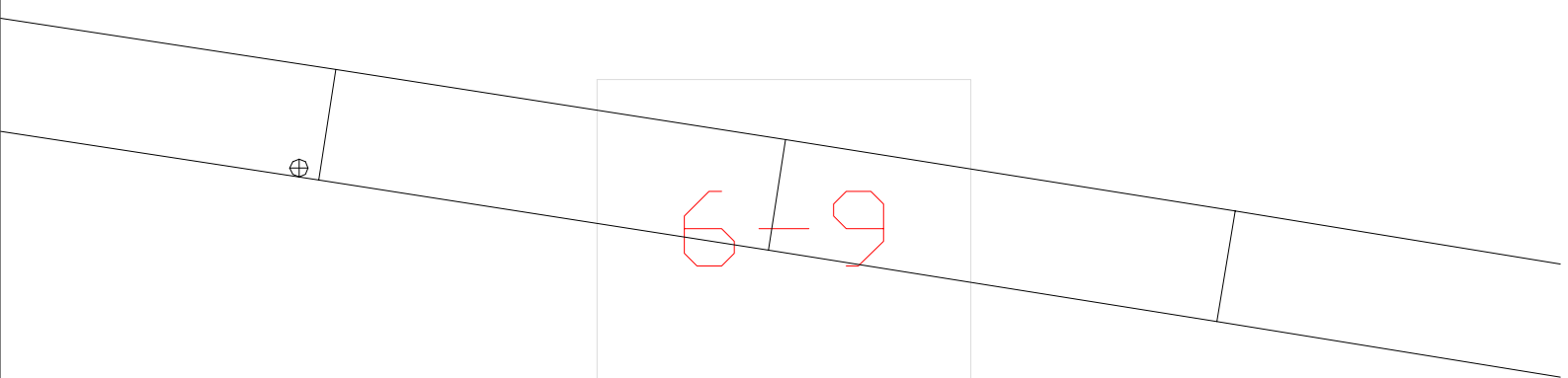

6-9

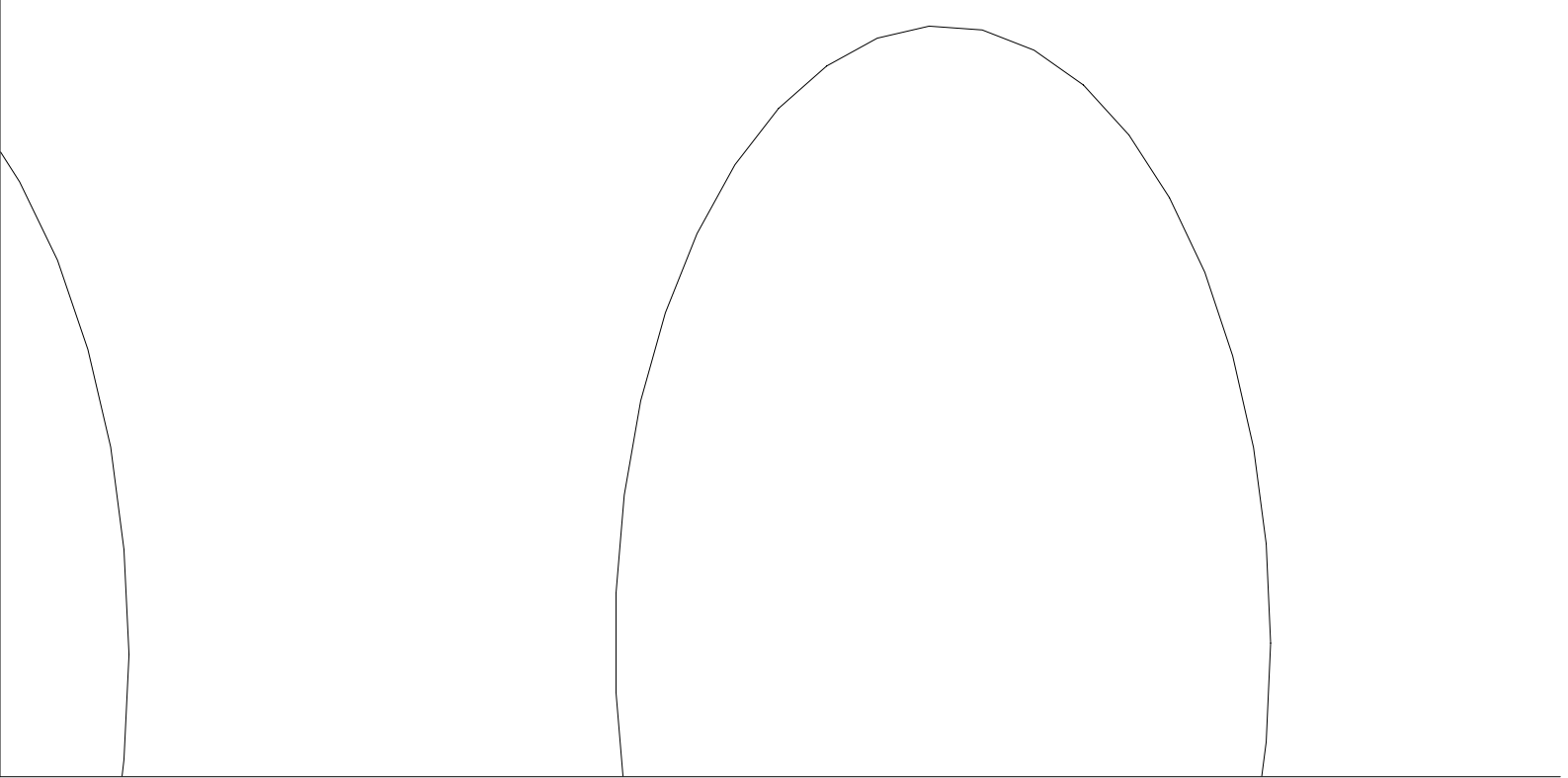

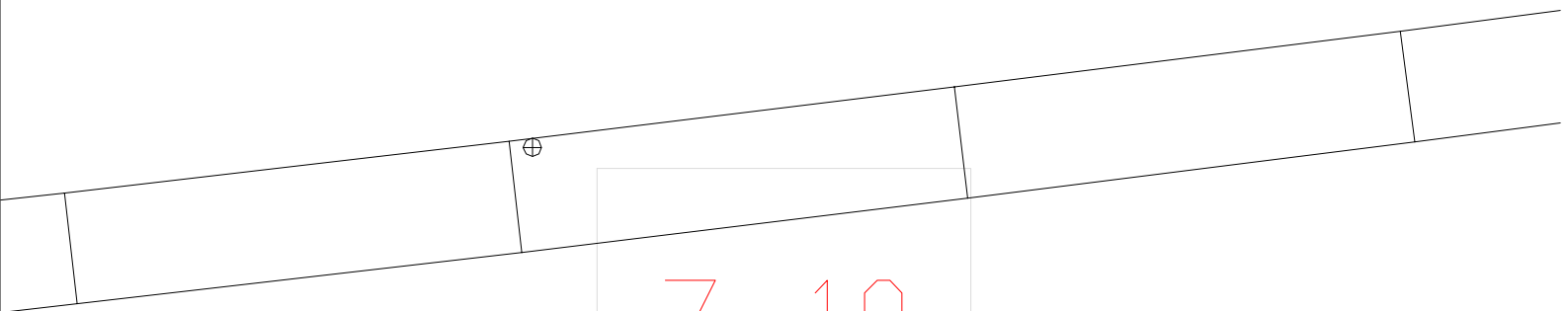
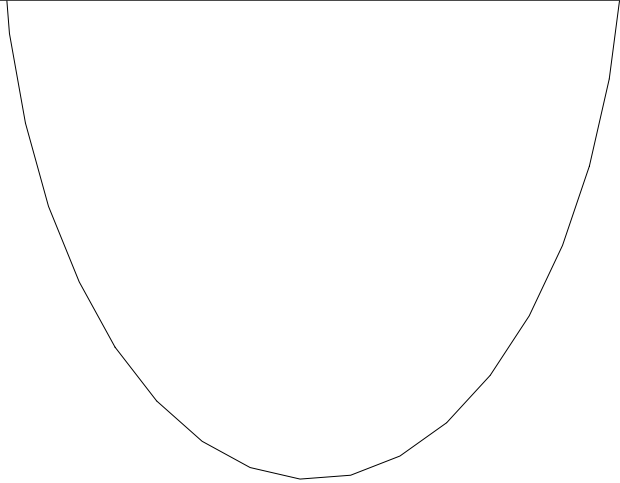

7-10

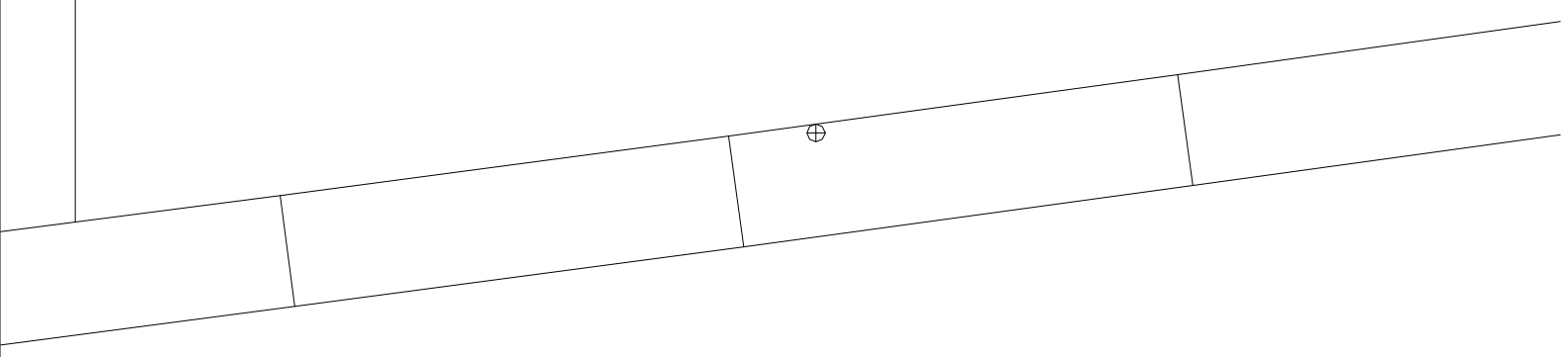
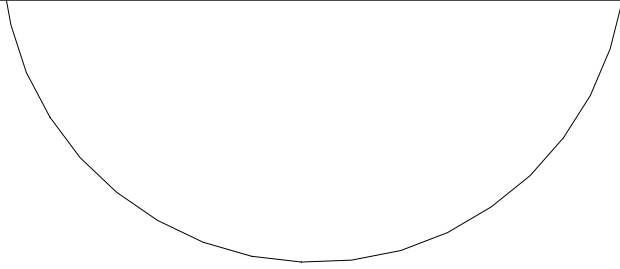

7-11

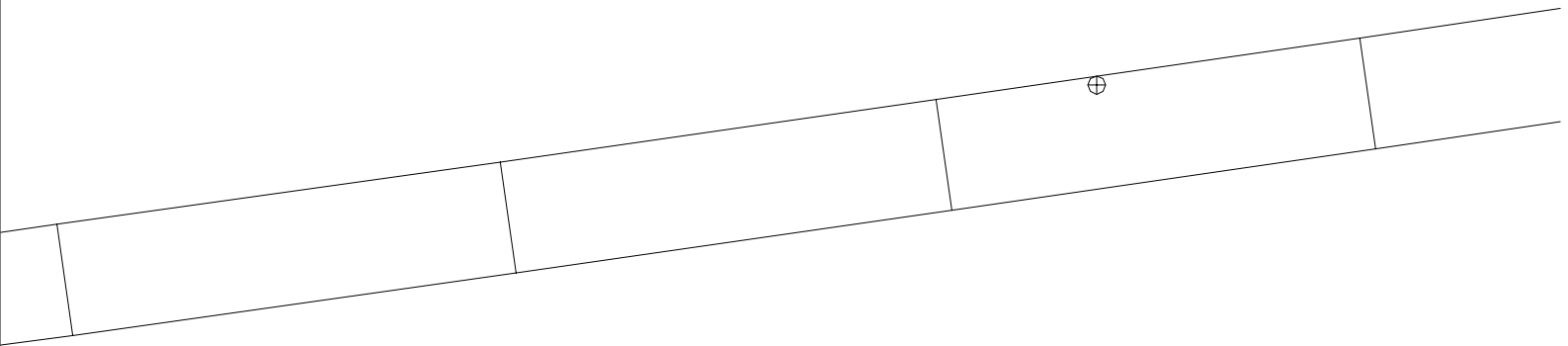

7-12

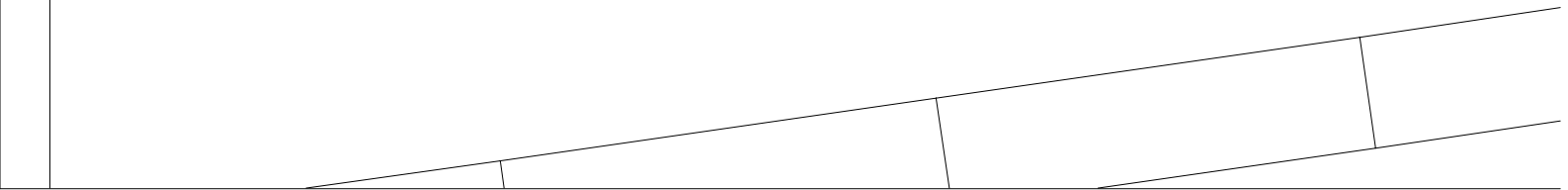
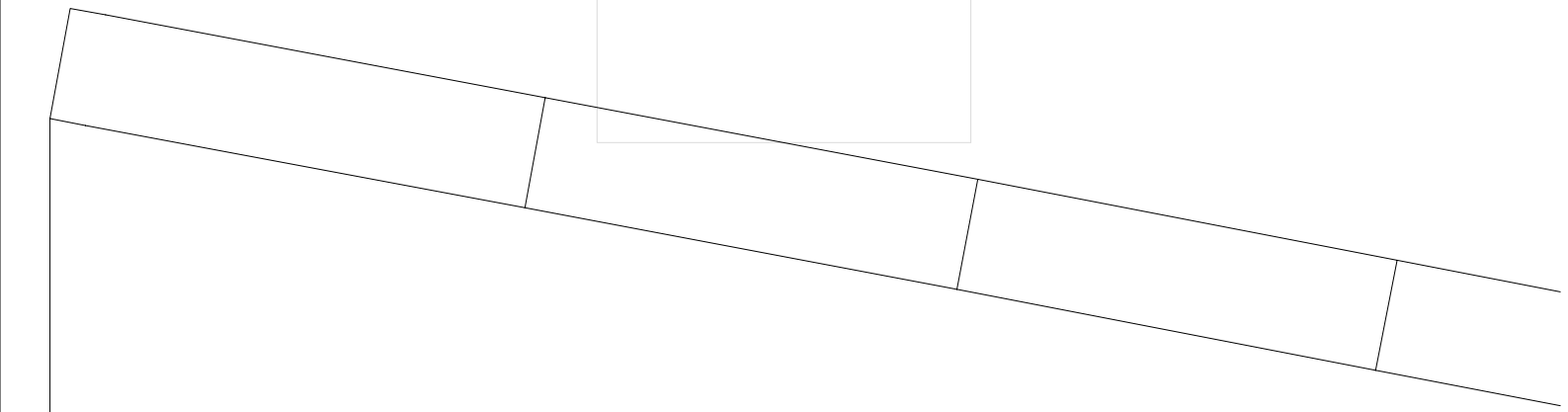

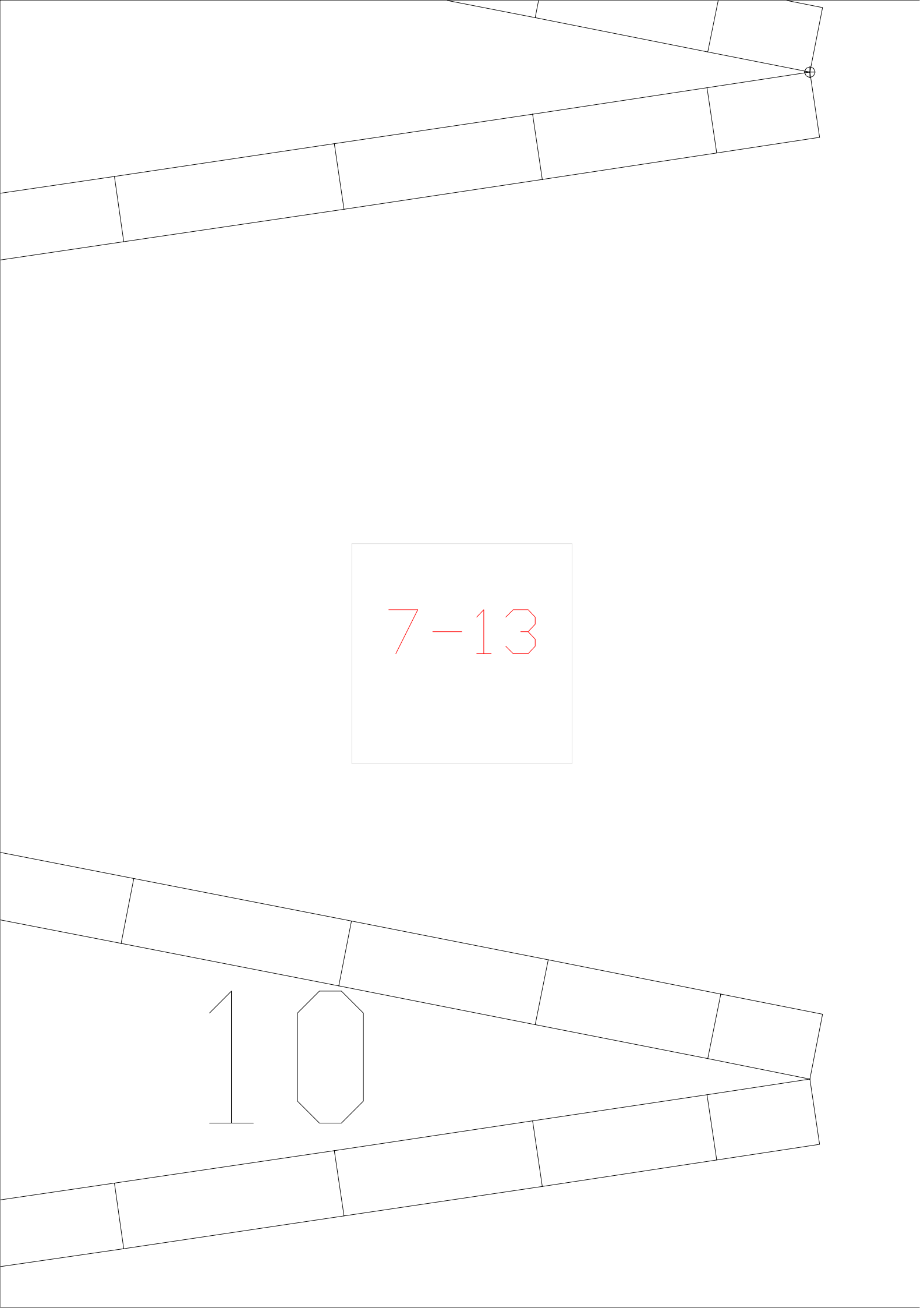

7-13

10

7-14

7-15

7-16



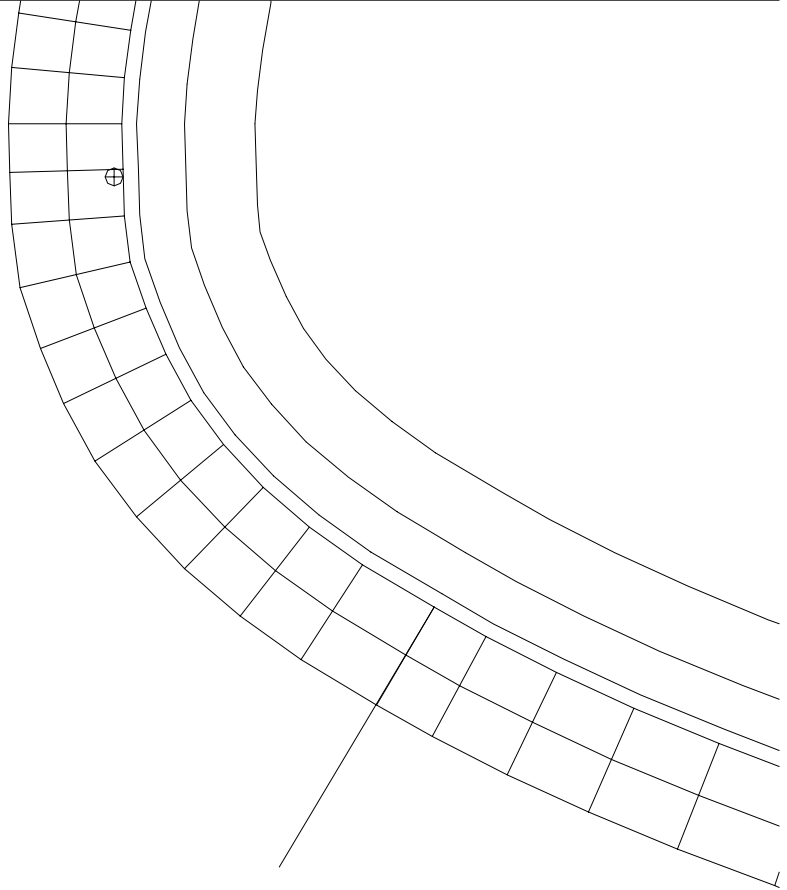

7-1

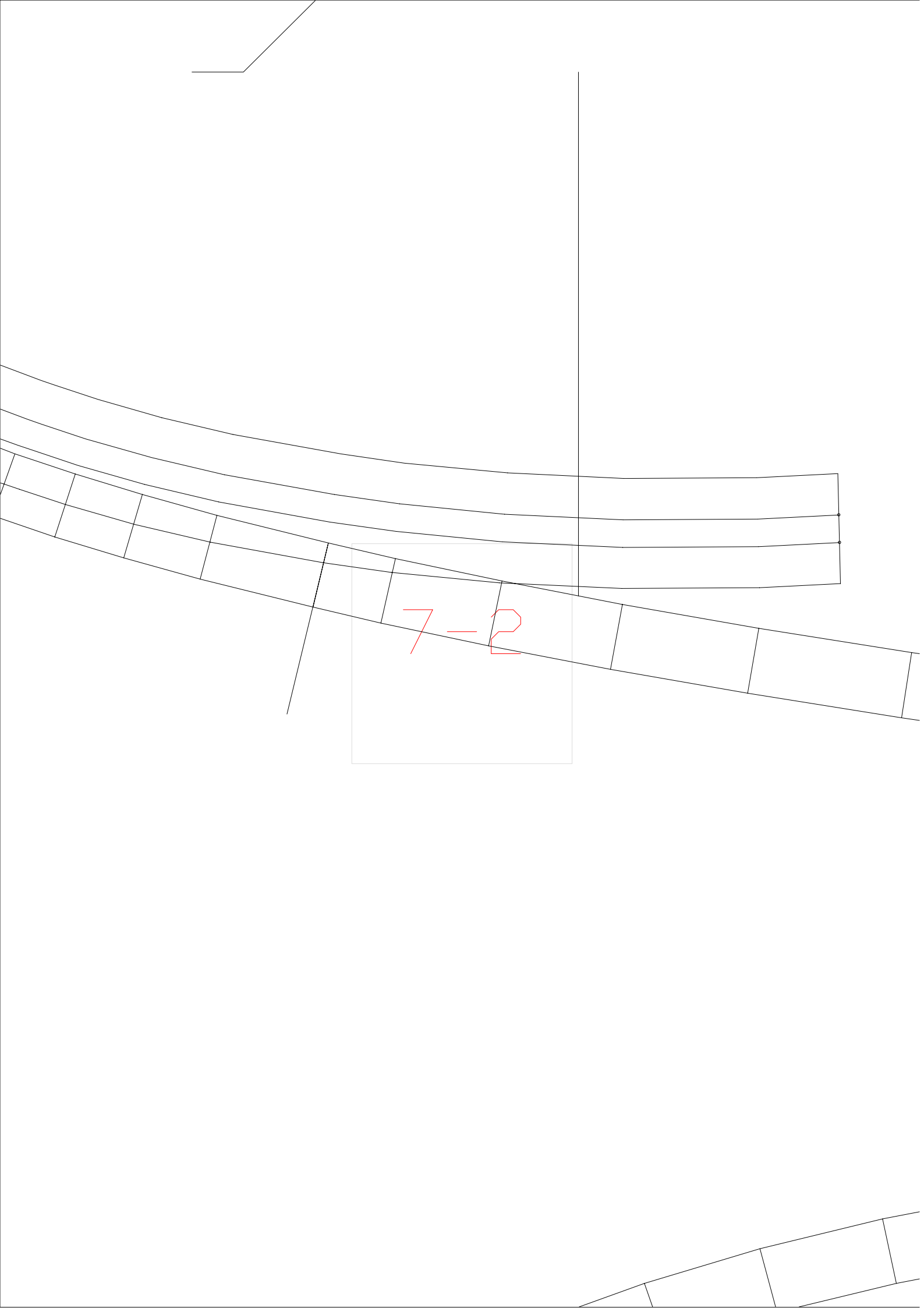

7-2



7-3

The image shows a technical drawing of a curved structure, possibly a pipe or duct, with a grid of rectangular sections. A central box highlights the text '7-3'. Two small circles with a cross inside are located on the grid lines. The top part of the drawing shows a large, smooth curve that tapers towards the center.

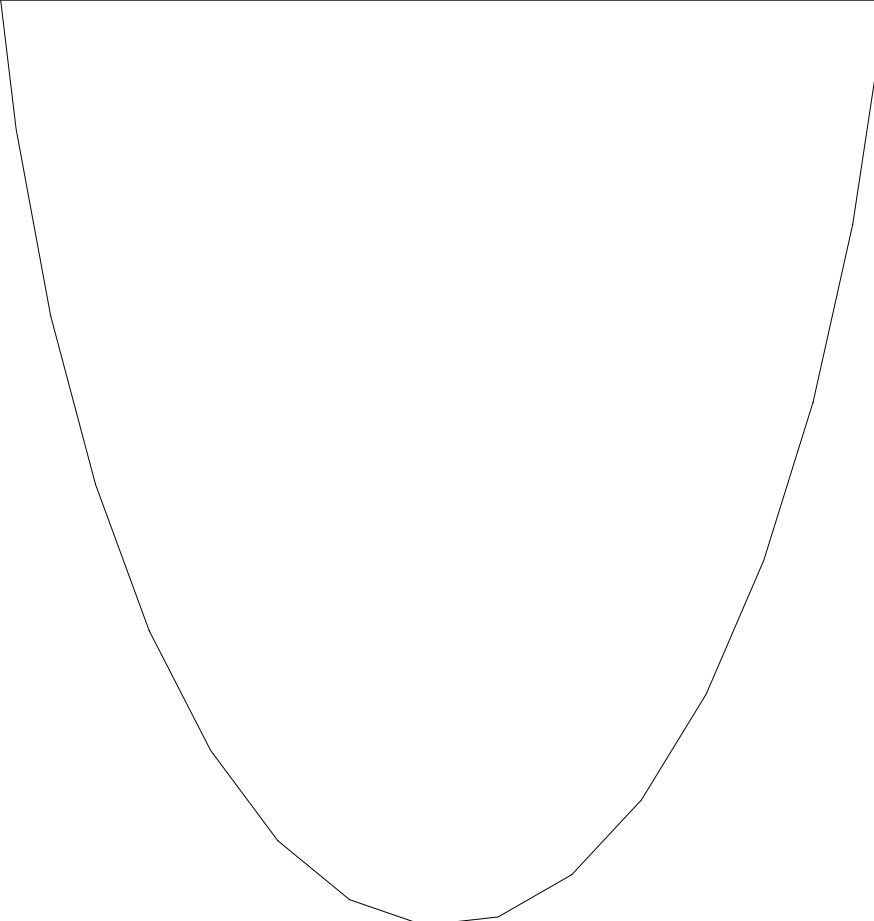

$$7 - 4$$

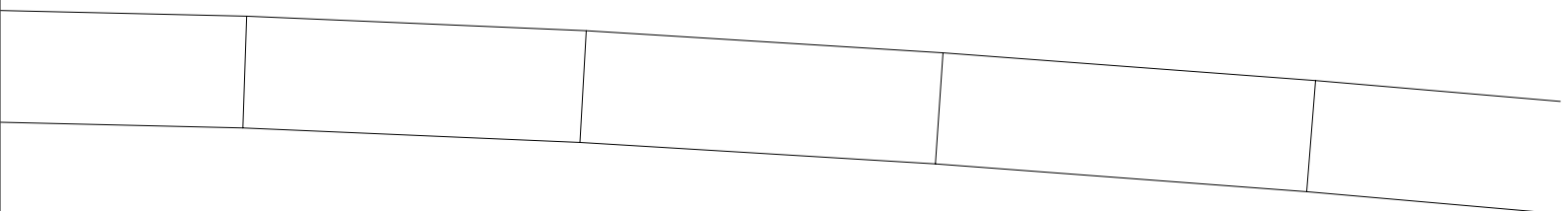
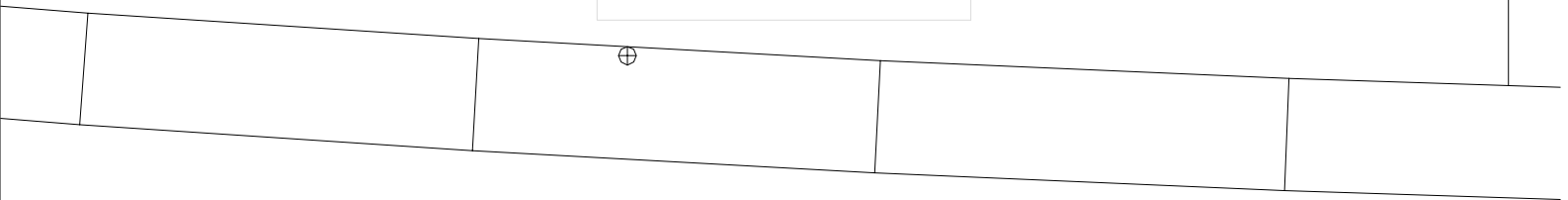



7-5

		⊕		
--	--	---	--	--

⊕				
---	--	--	--	--



7-6

			⊕
--	--	--	---



7-7

⊕



7-8



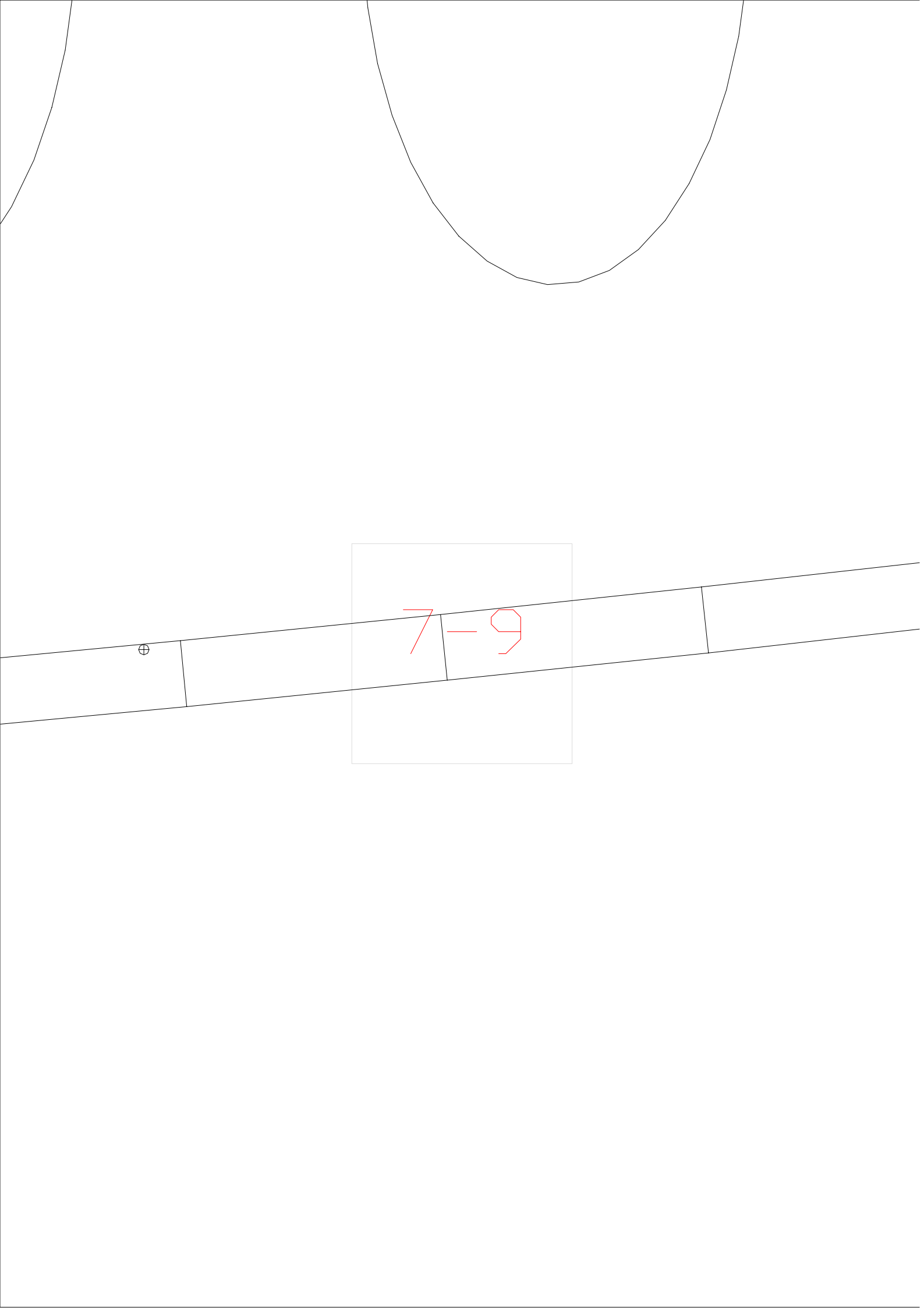

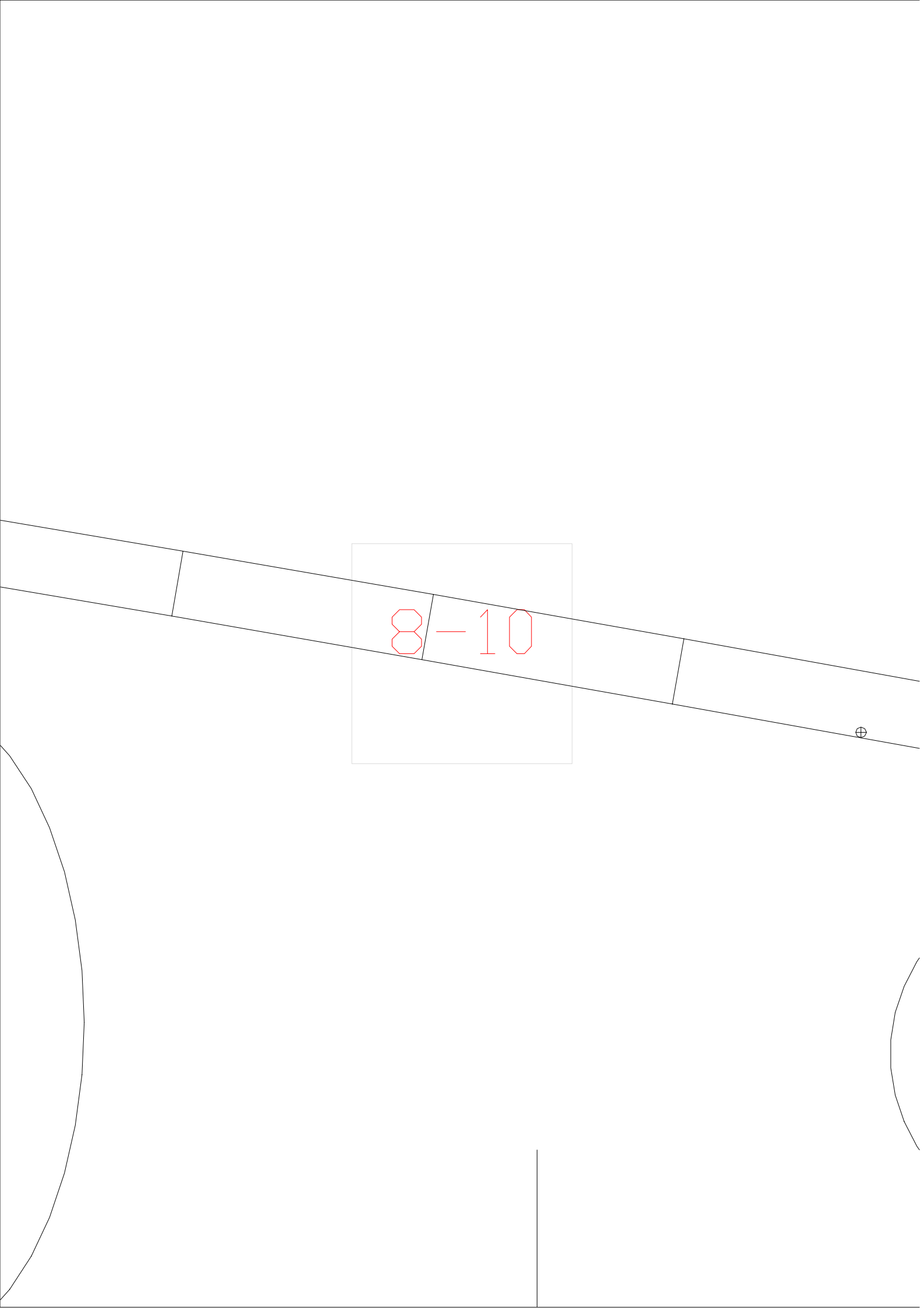

8-10



8-11

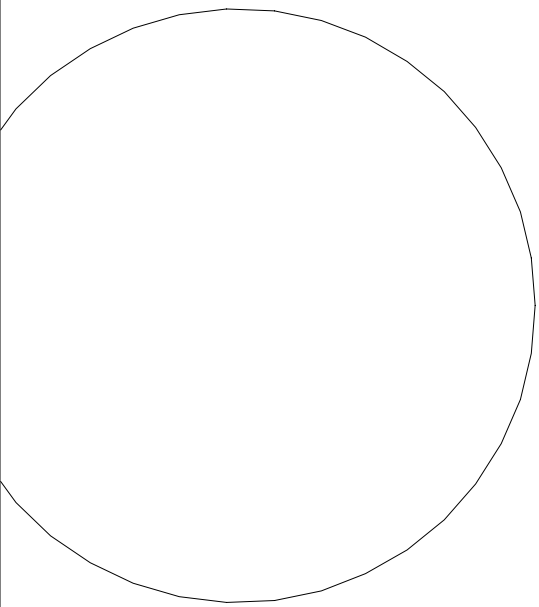
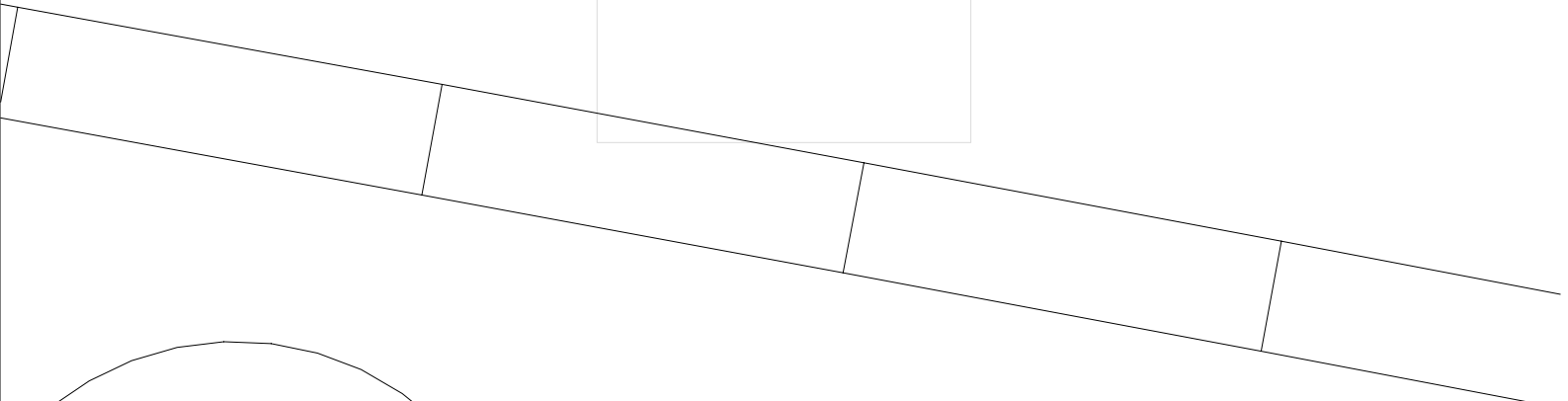

8-12

8-13

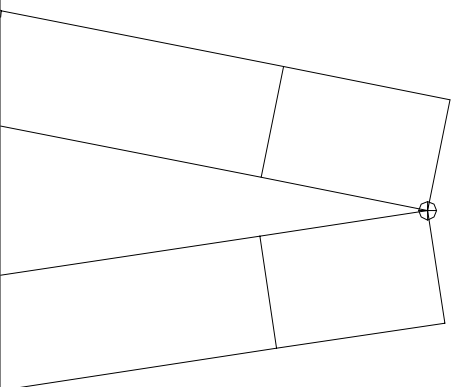

$$8 - 14$$

8-15

8-16



8-1

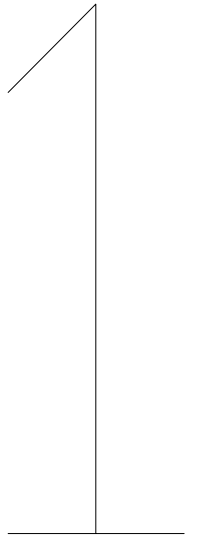
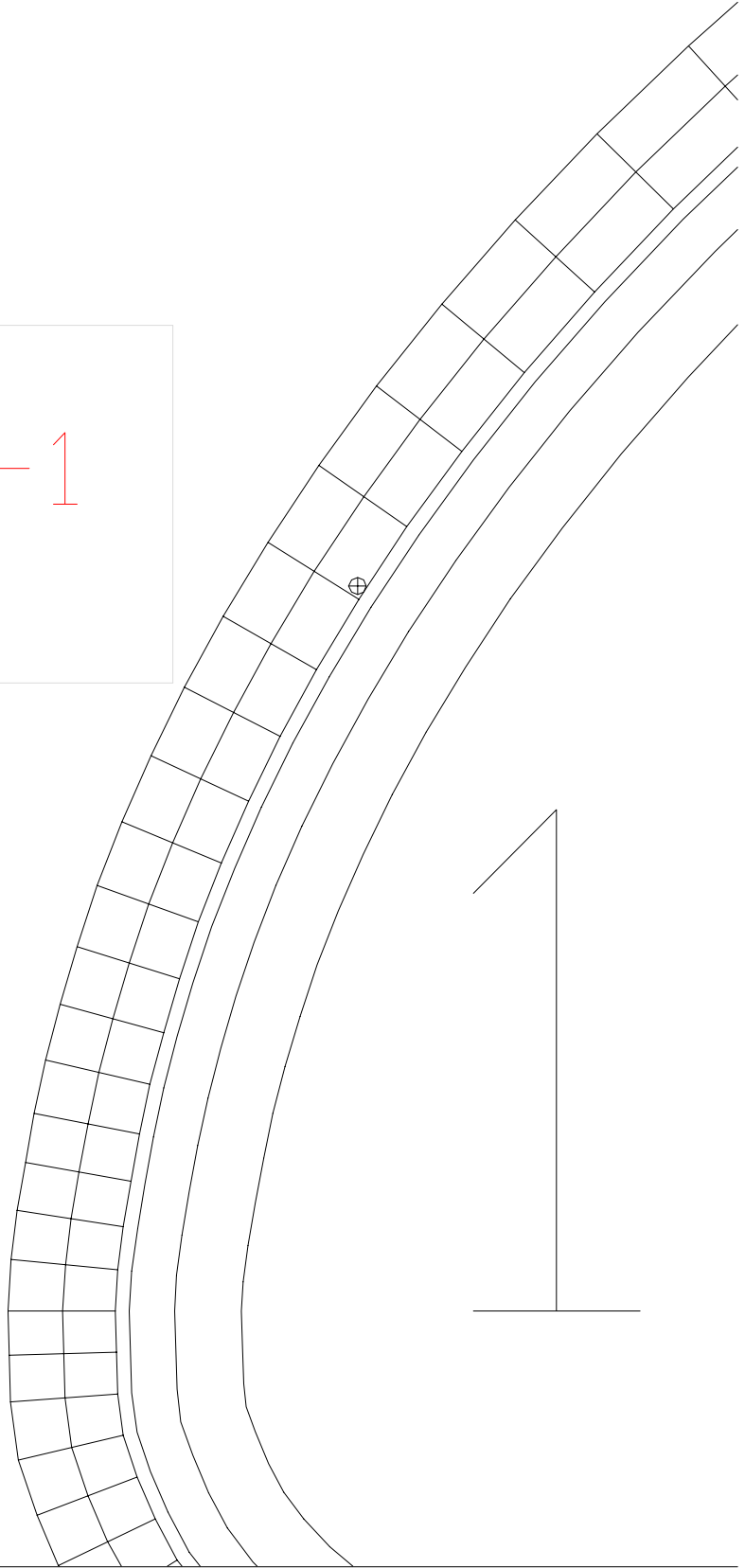

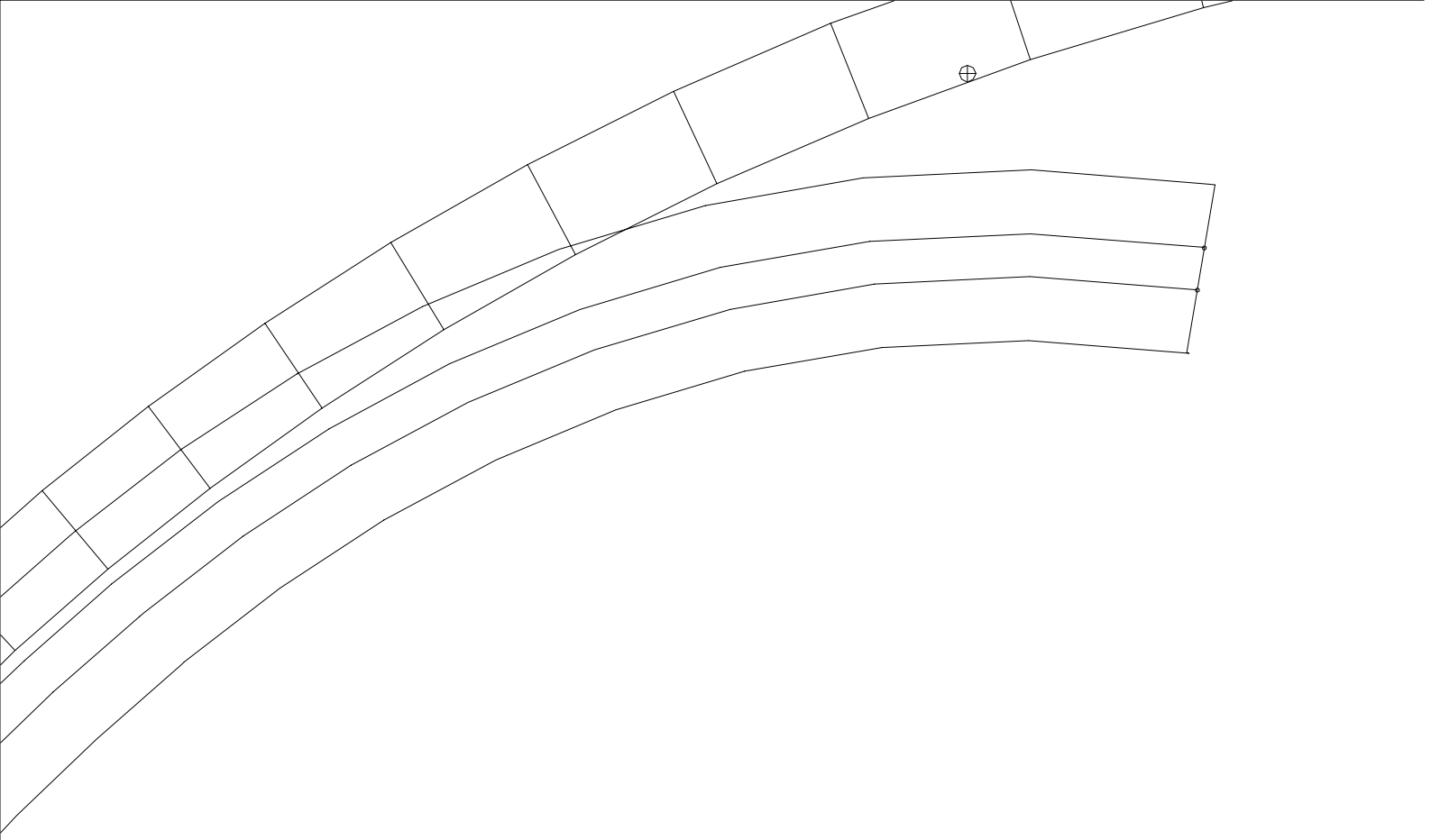

8-2

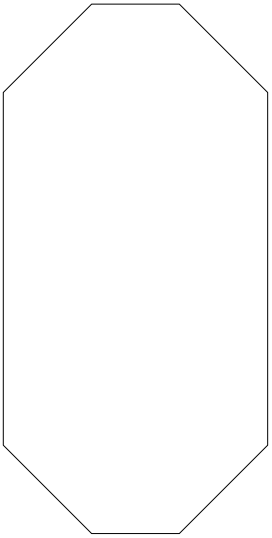



8-3



8-4



8-5

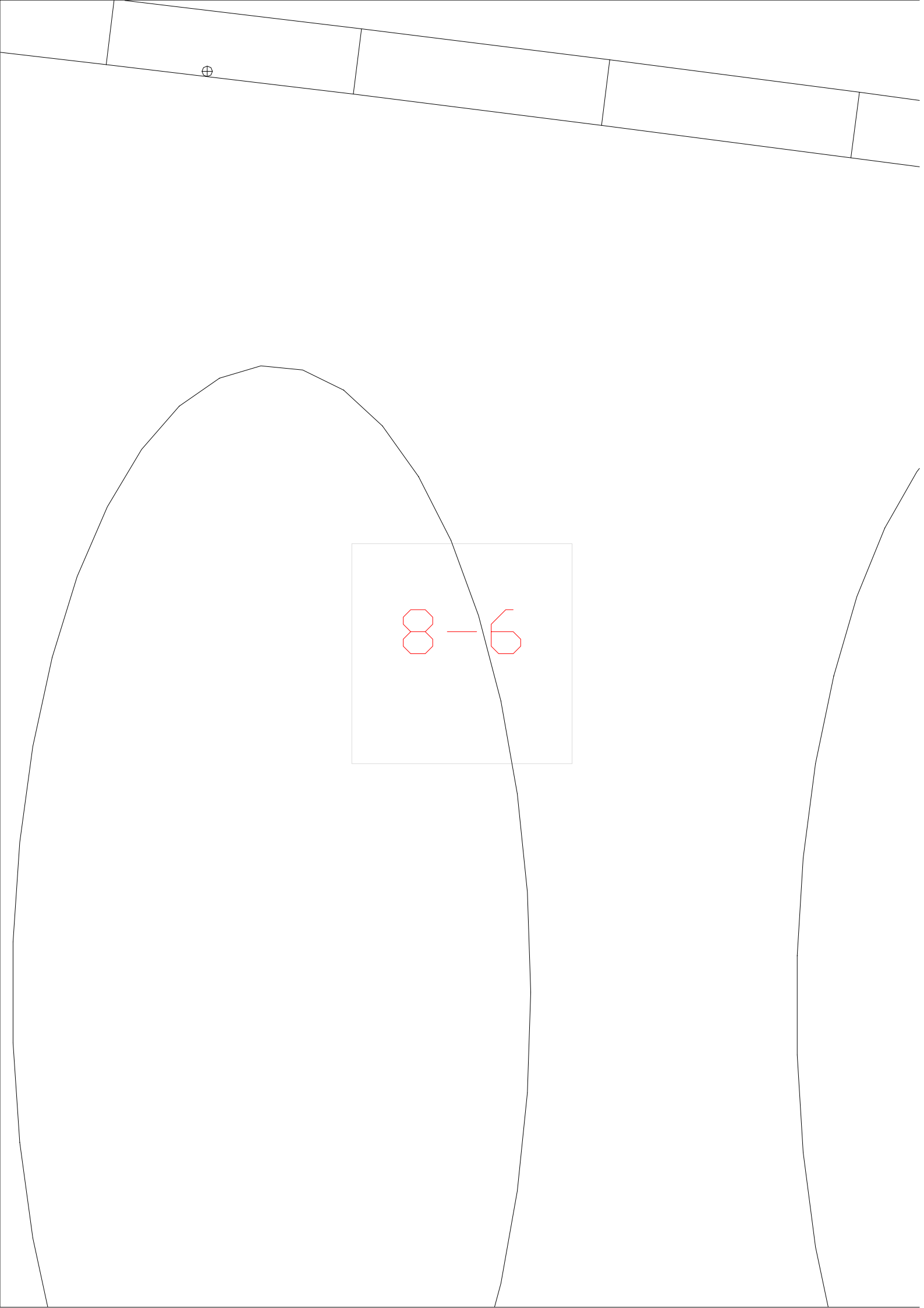

8-6

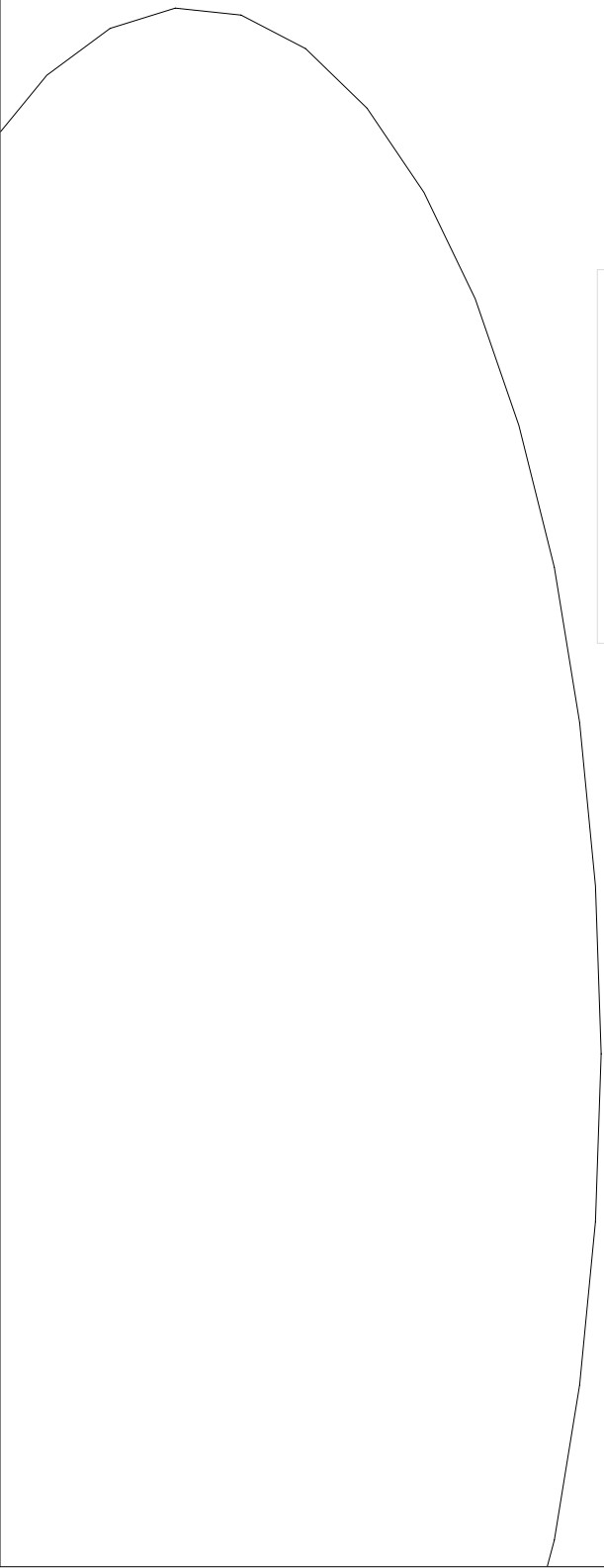
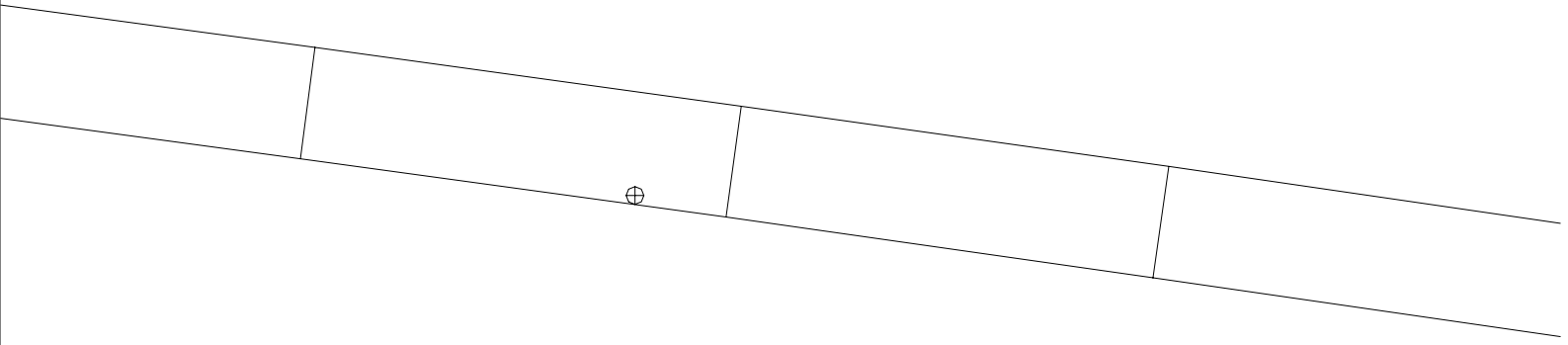

8-7



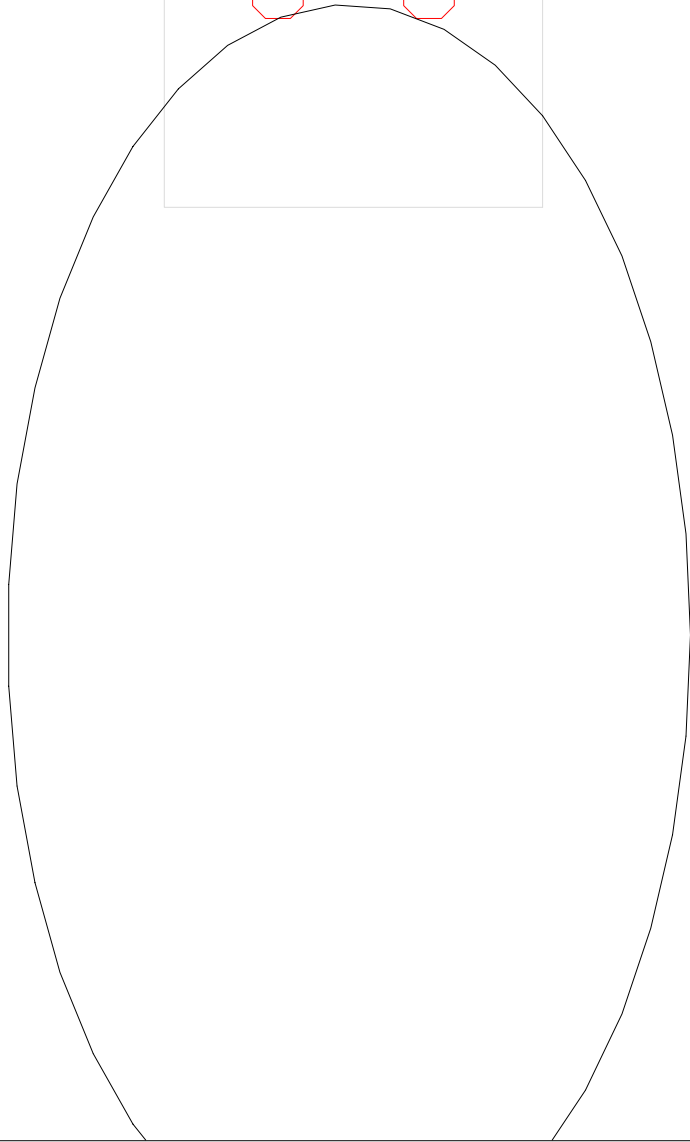
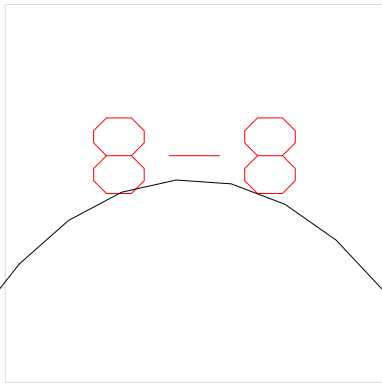
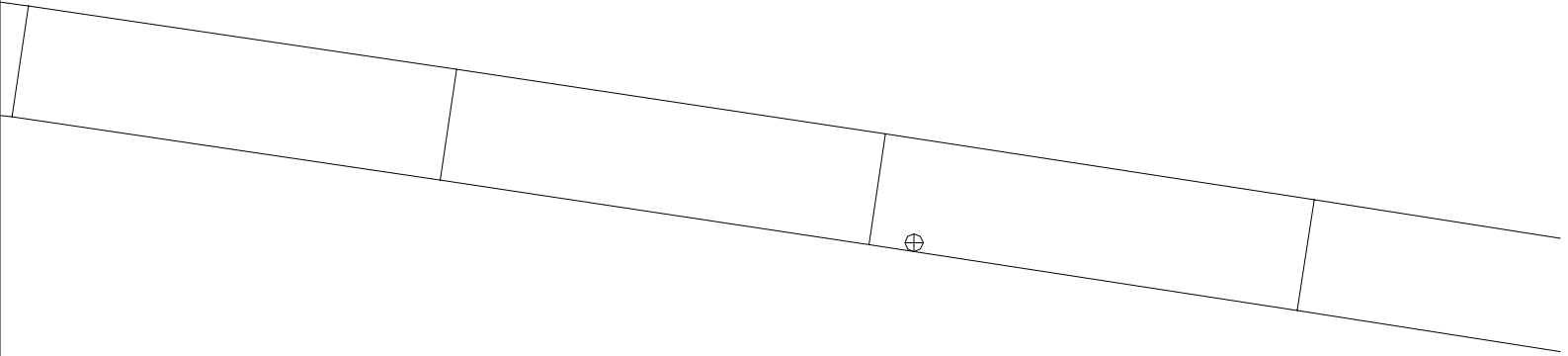



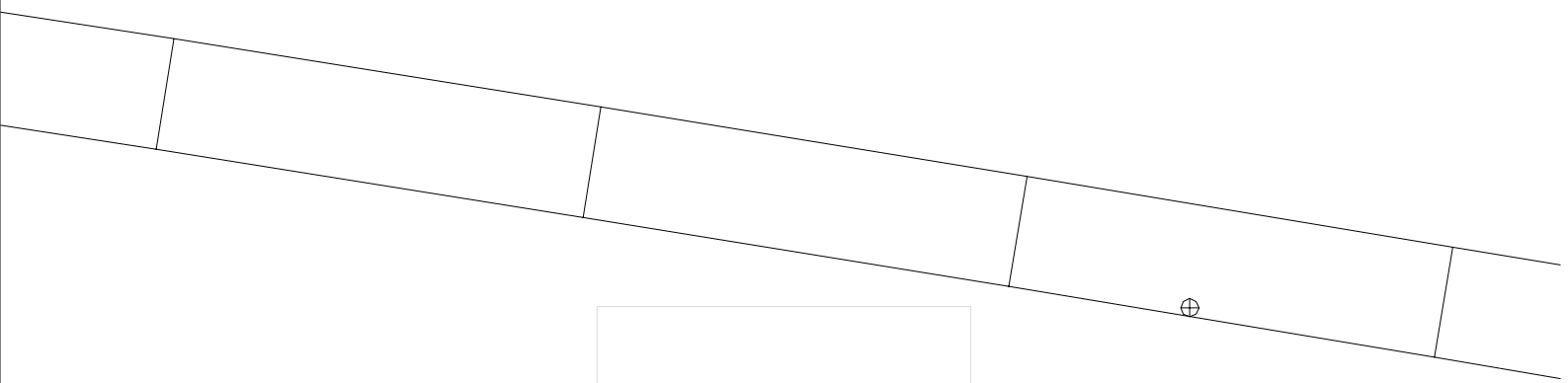

8-9

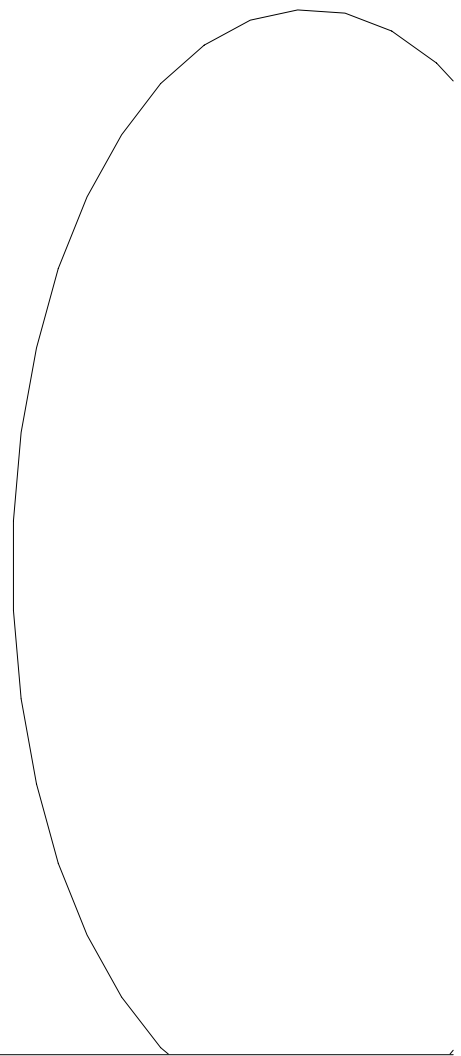
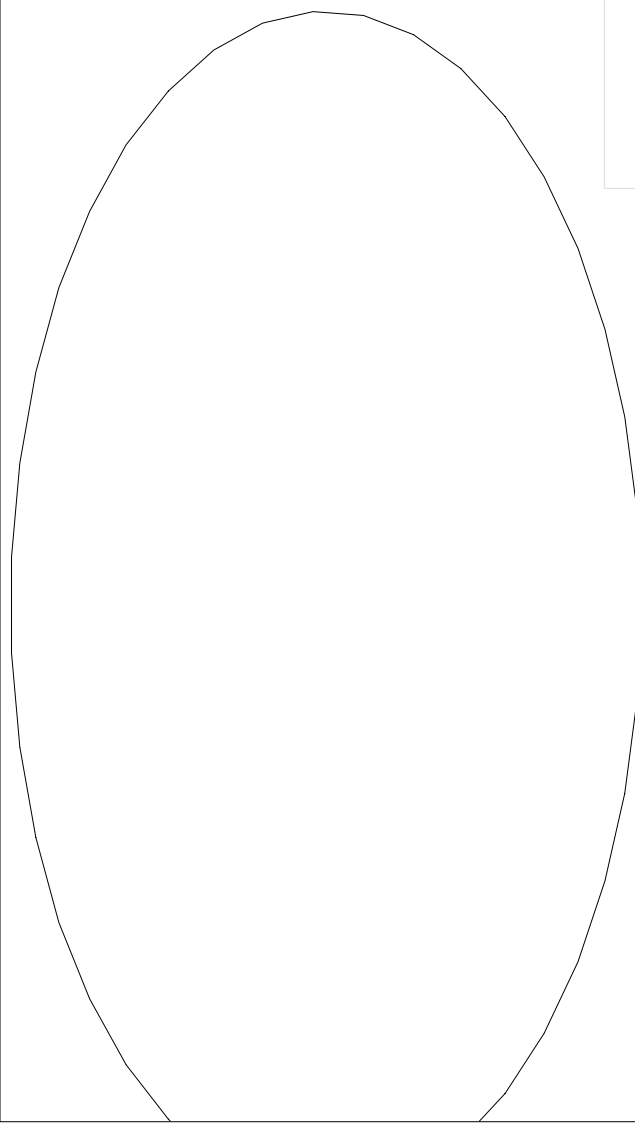

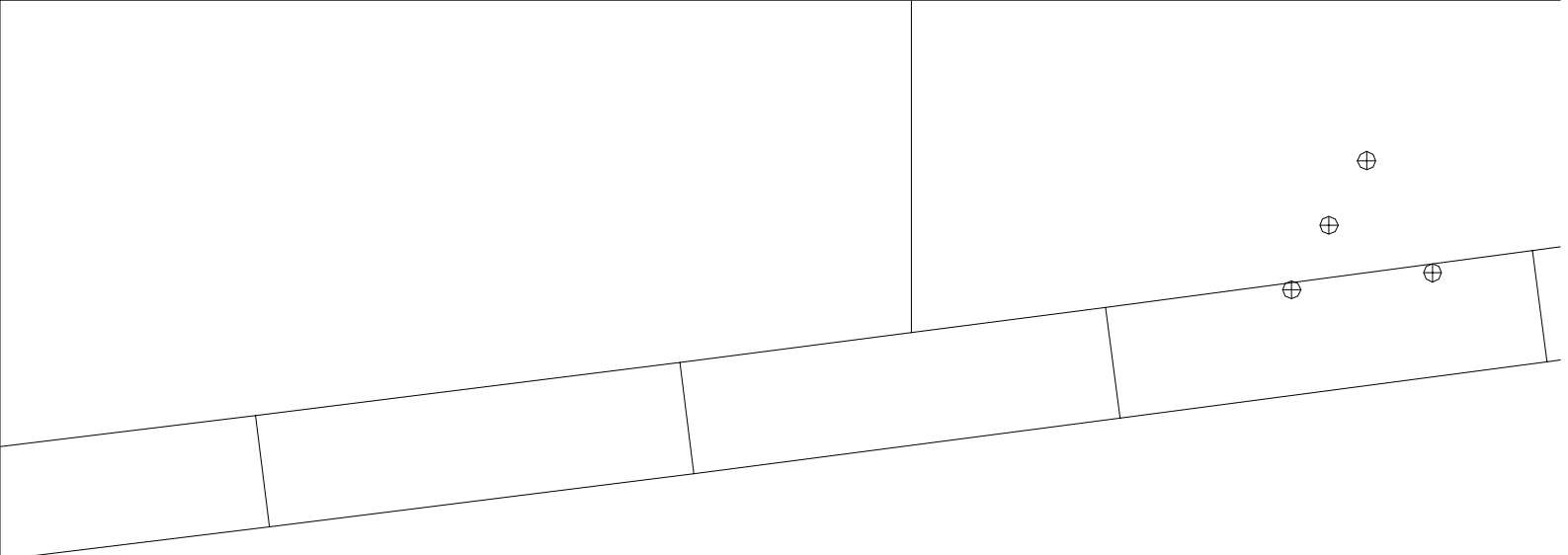

9-10

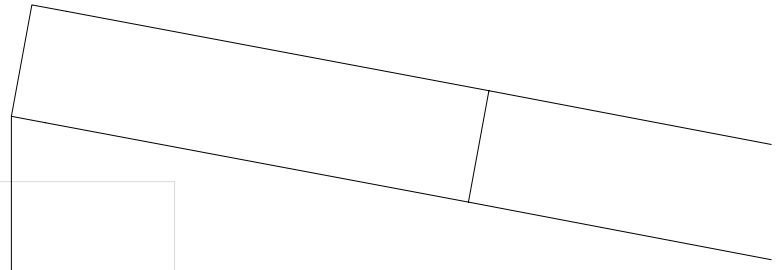
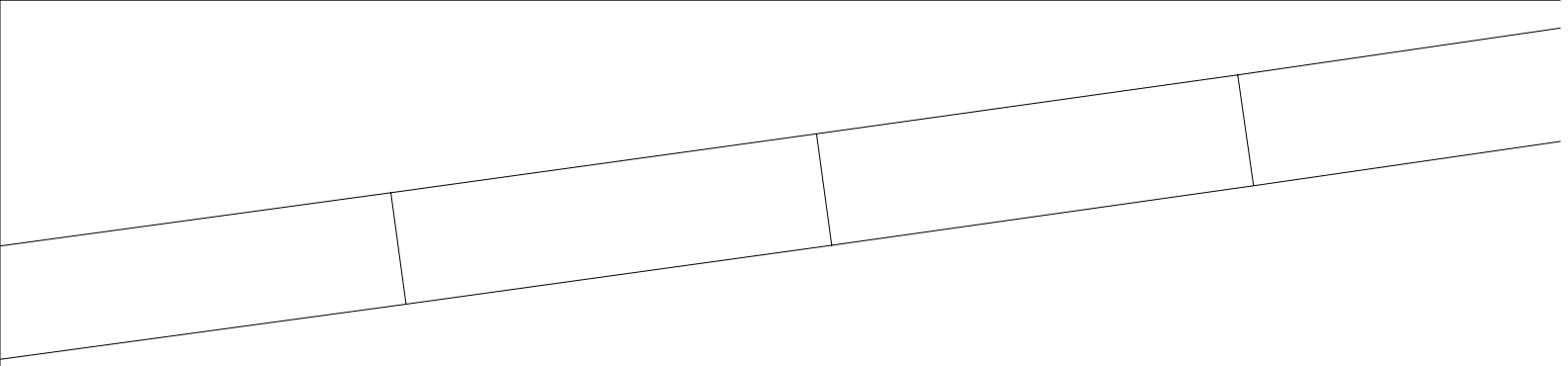

9-11

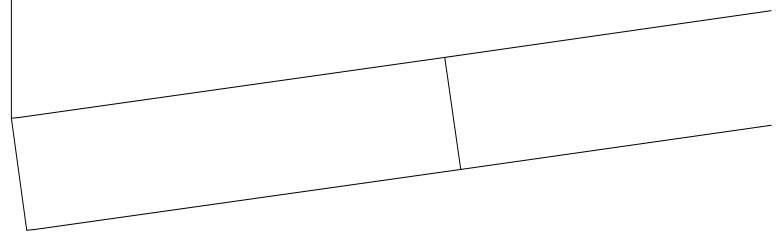

⊕

9-12

1

1

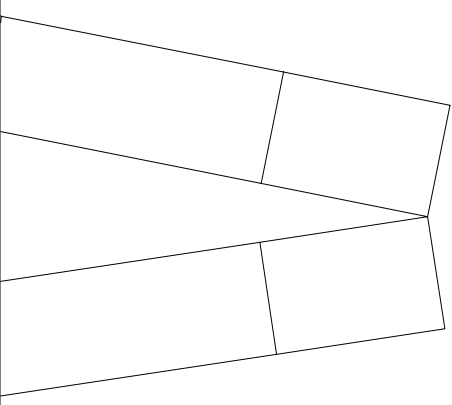

9-13

9-14

9-15

9-16



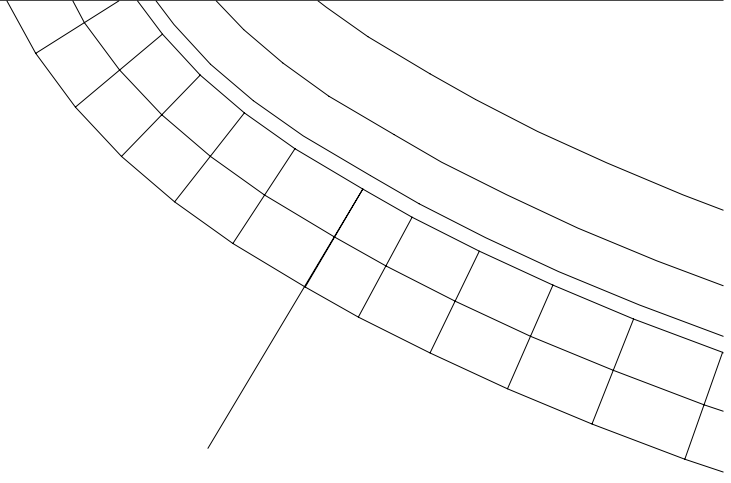

9-1



9-2

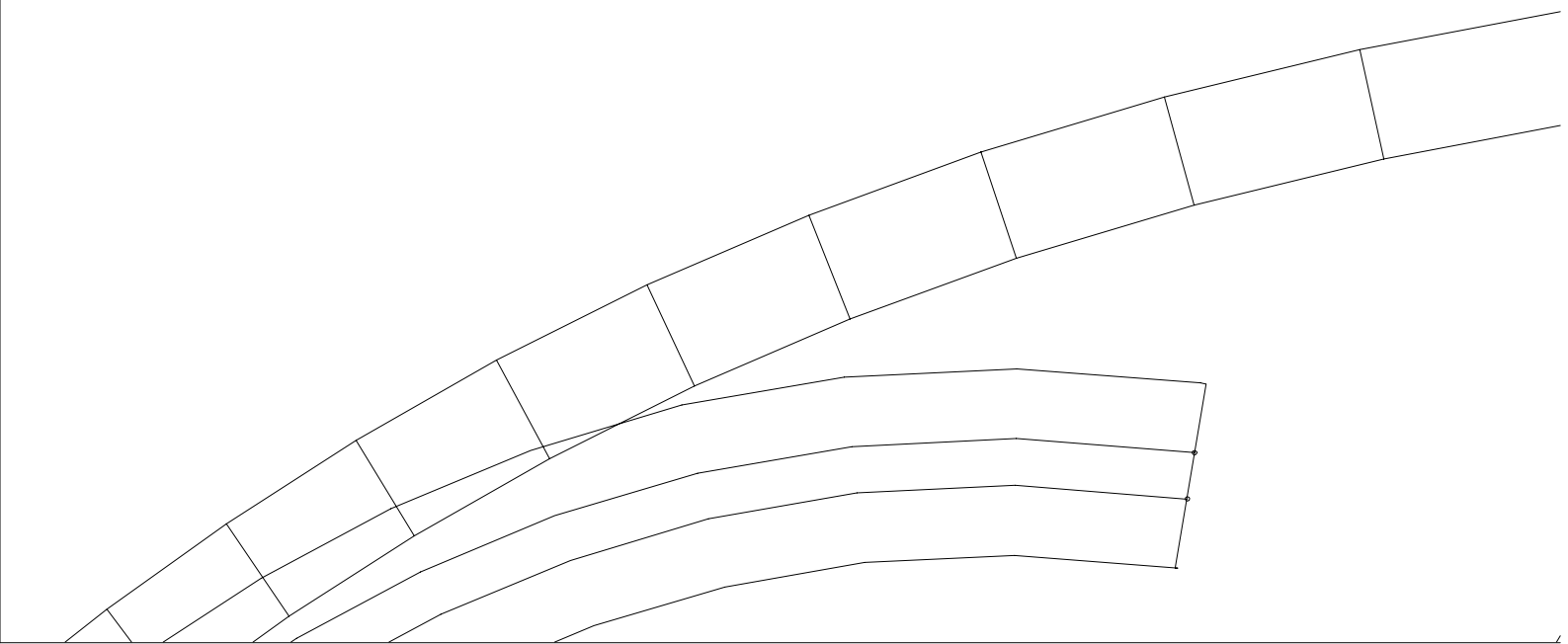

9-3

The image shows a technical drawing of a curved structure, possibly a pipe or duct, divided into several segments. A central rectangular box contains the text '9-3' in red. There are two small circles with a cross inside, one on the upper curve and one on the lower curve, likely representing fasteners or markers. The drawing is a line drawing with no shading.

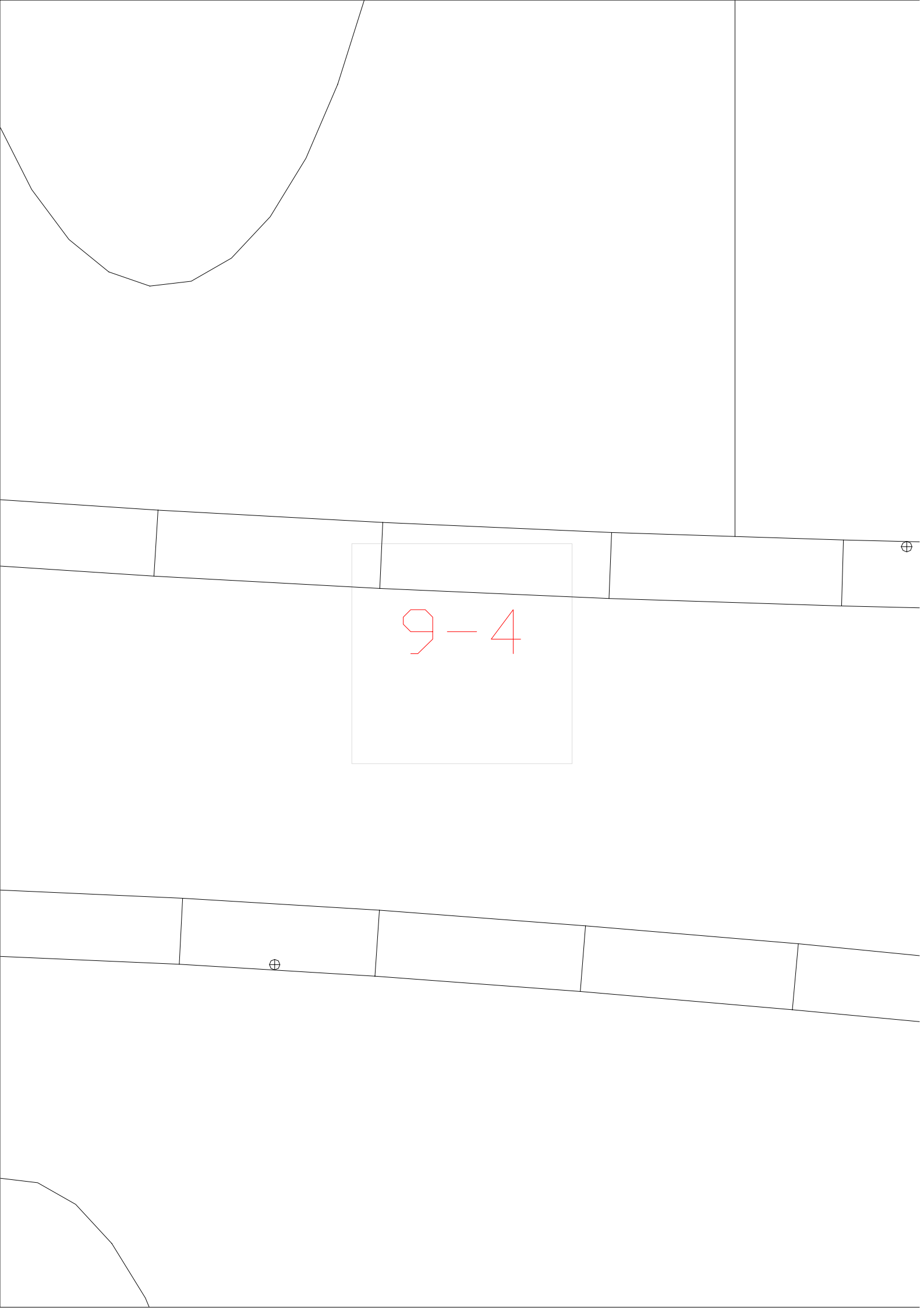

9-4

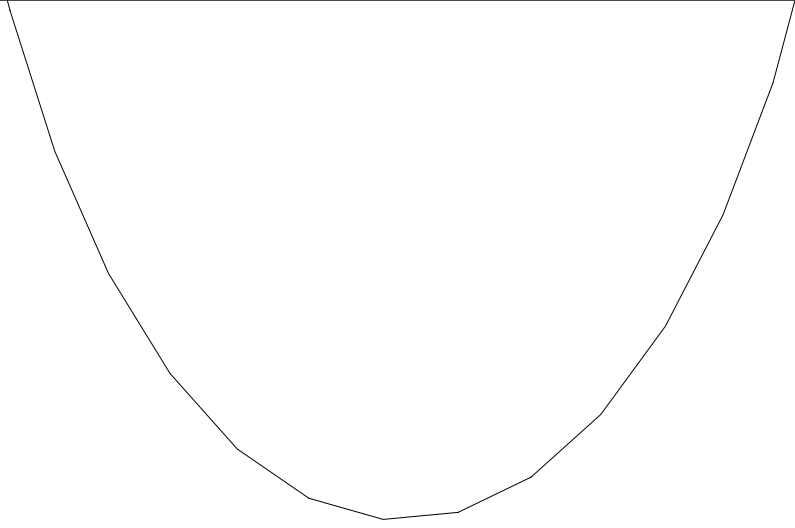

--	--	--	--	--	--	--

9-5

--	--	--	--	--

⊕

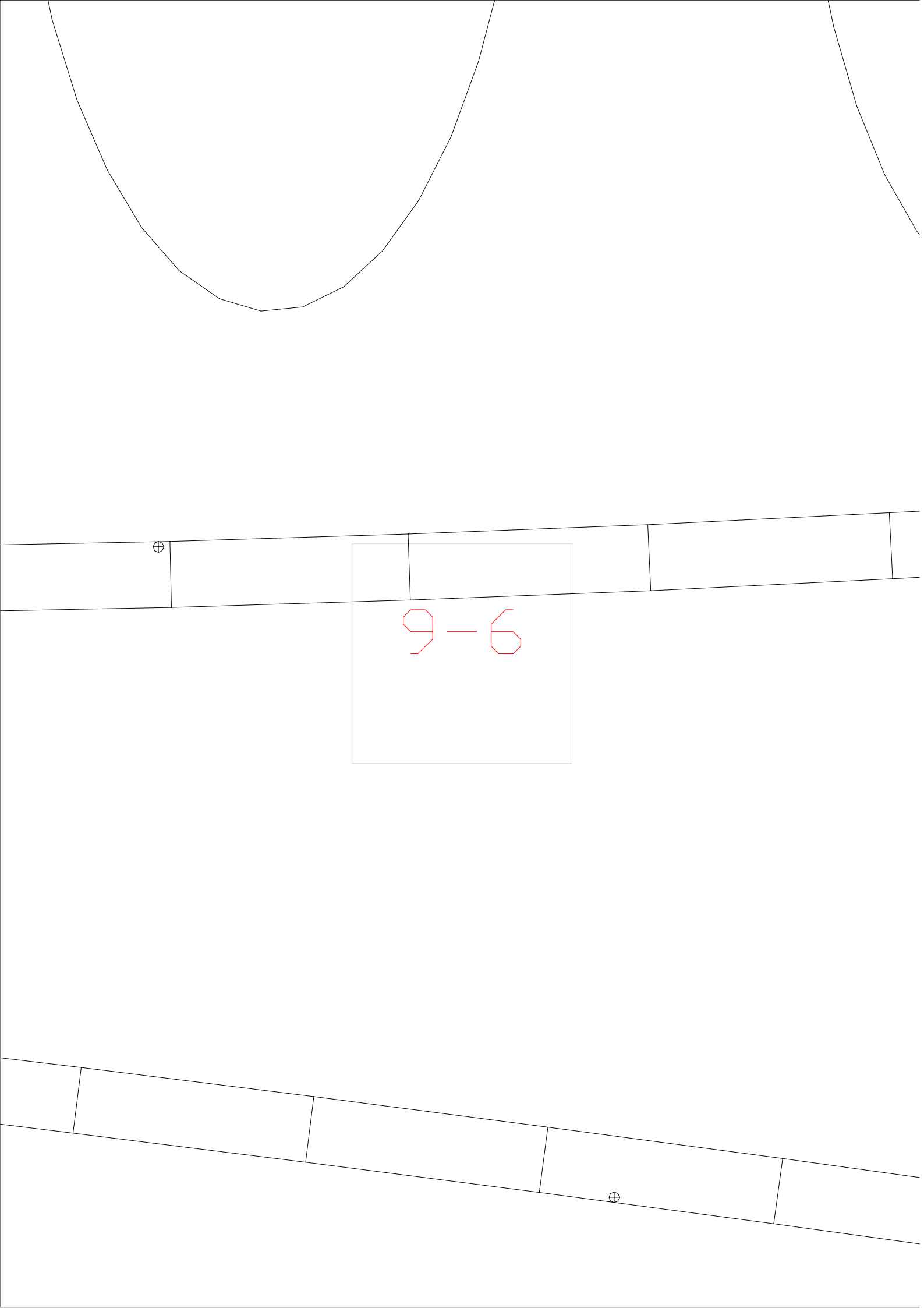

9-6

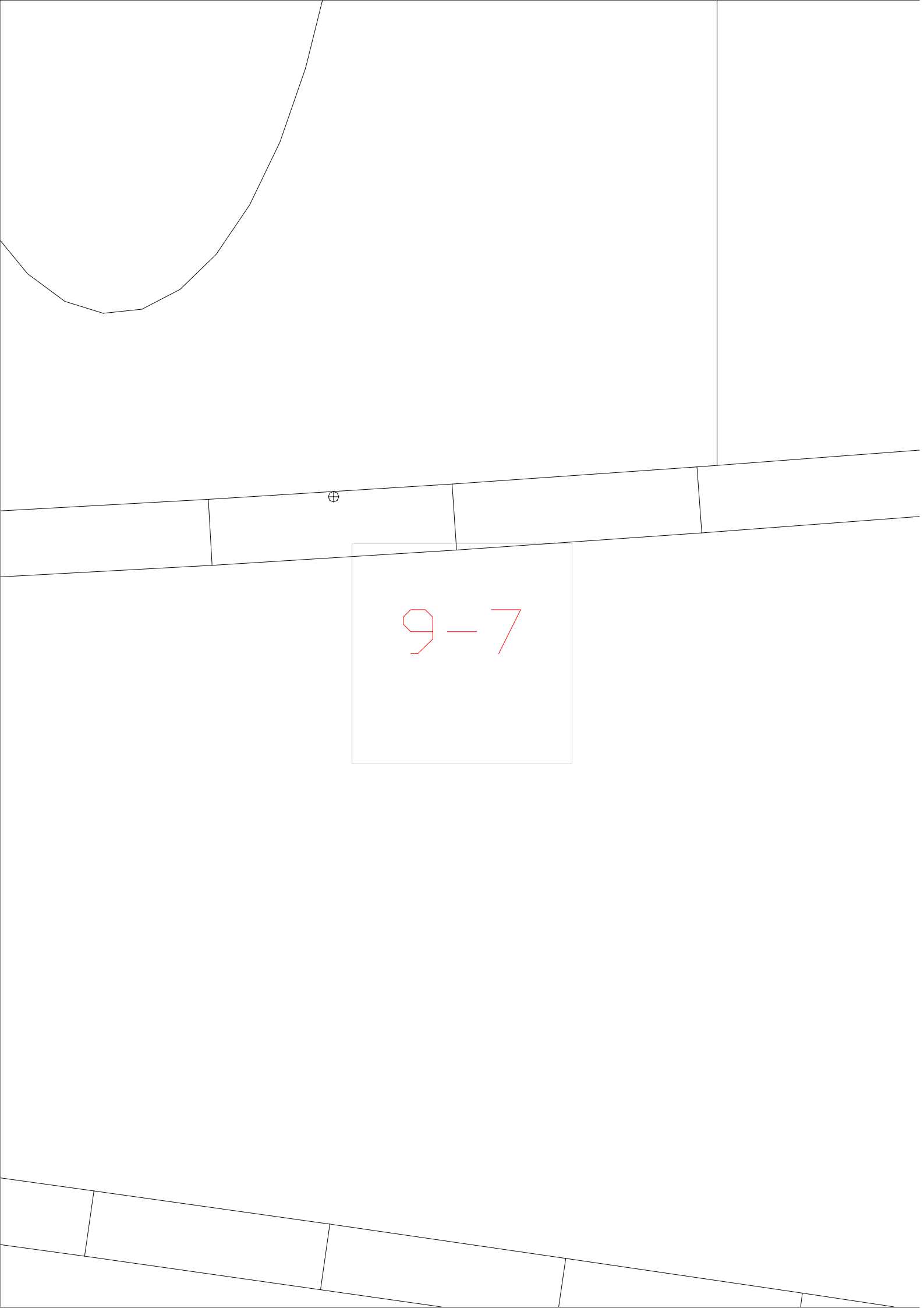

9-7

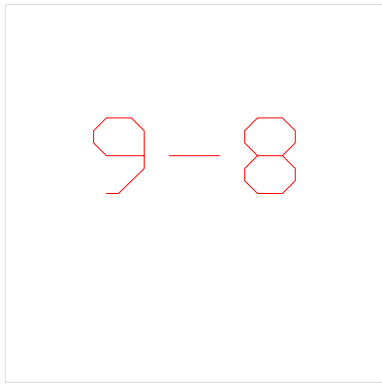
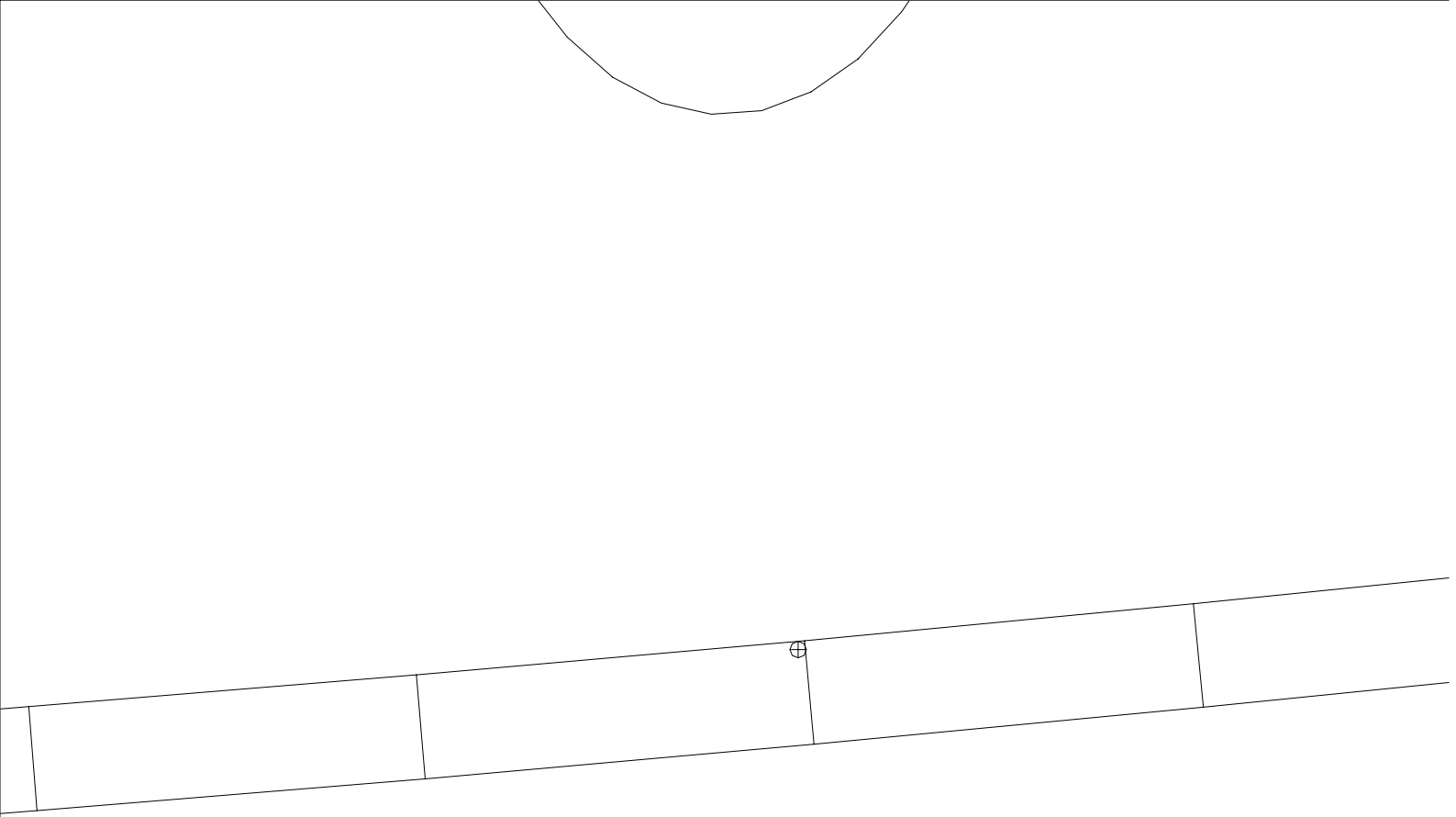



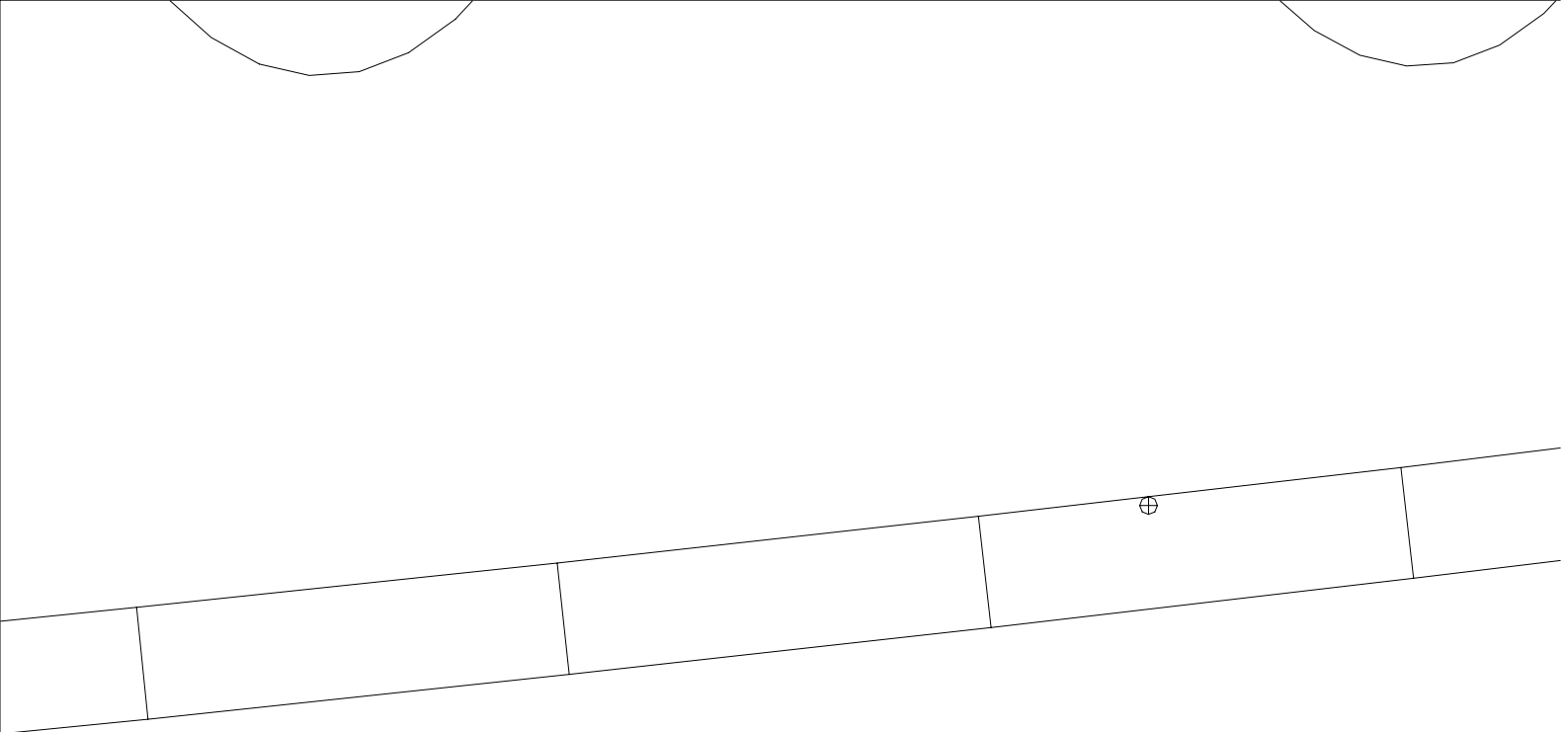

9-9