

10-10

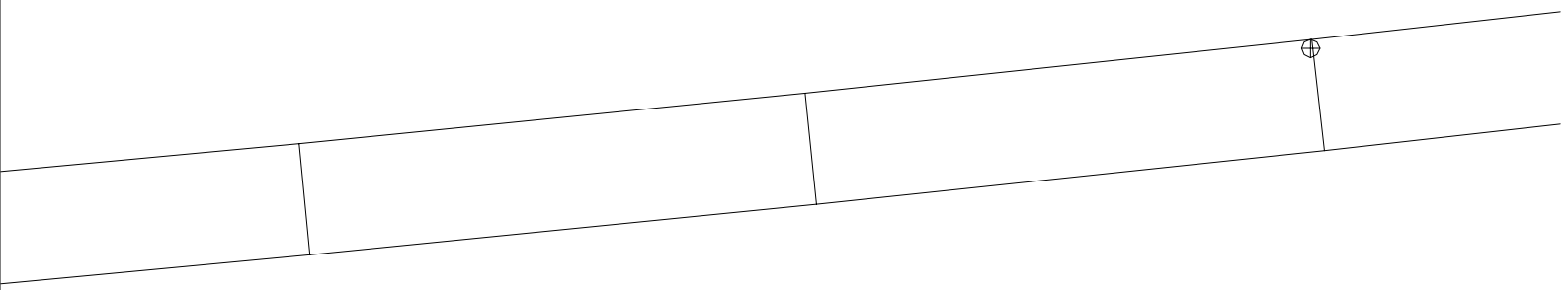

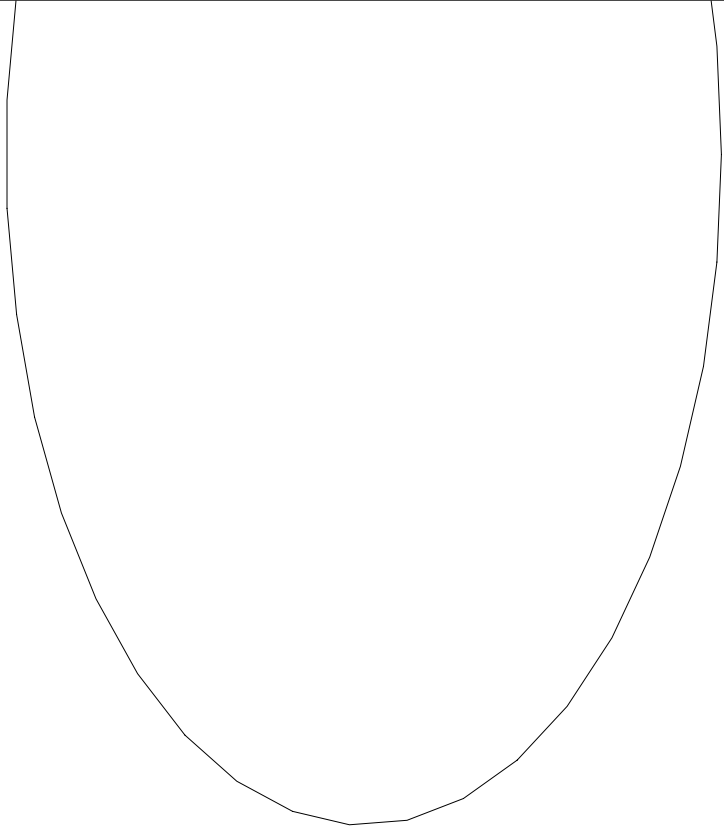

10-11

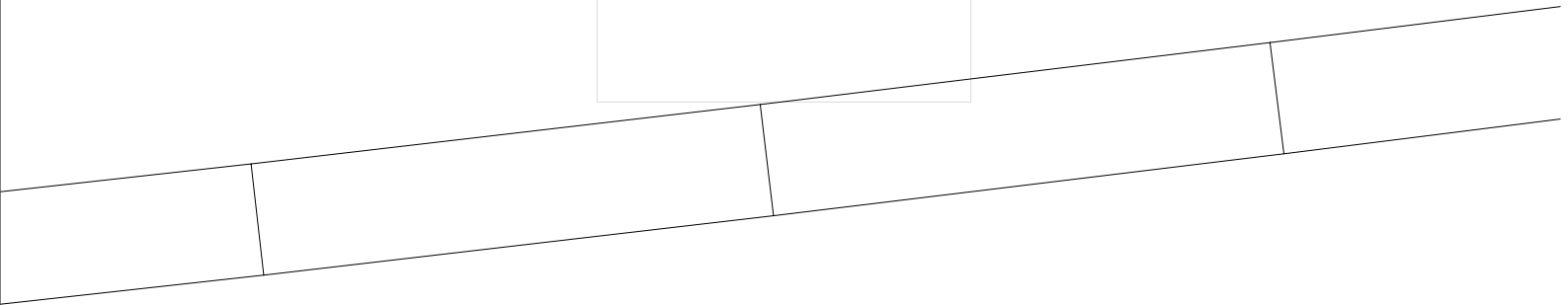

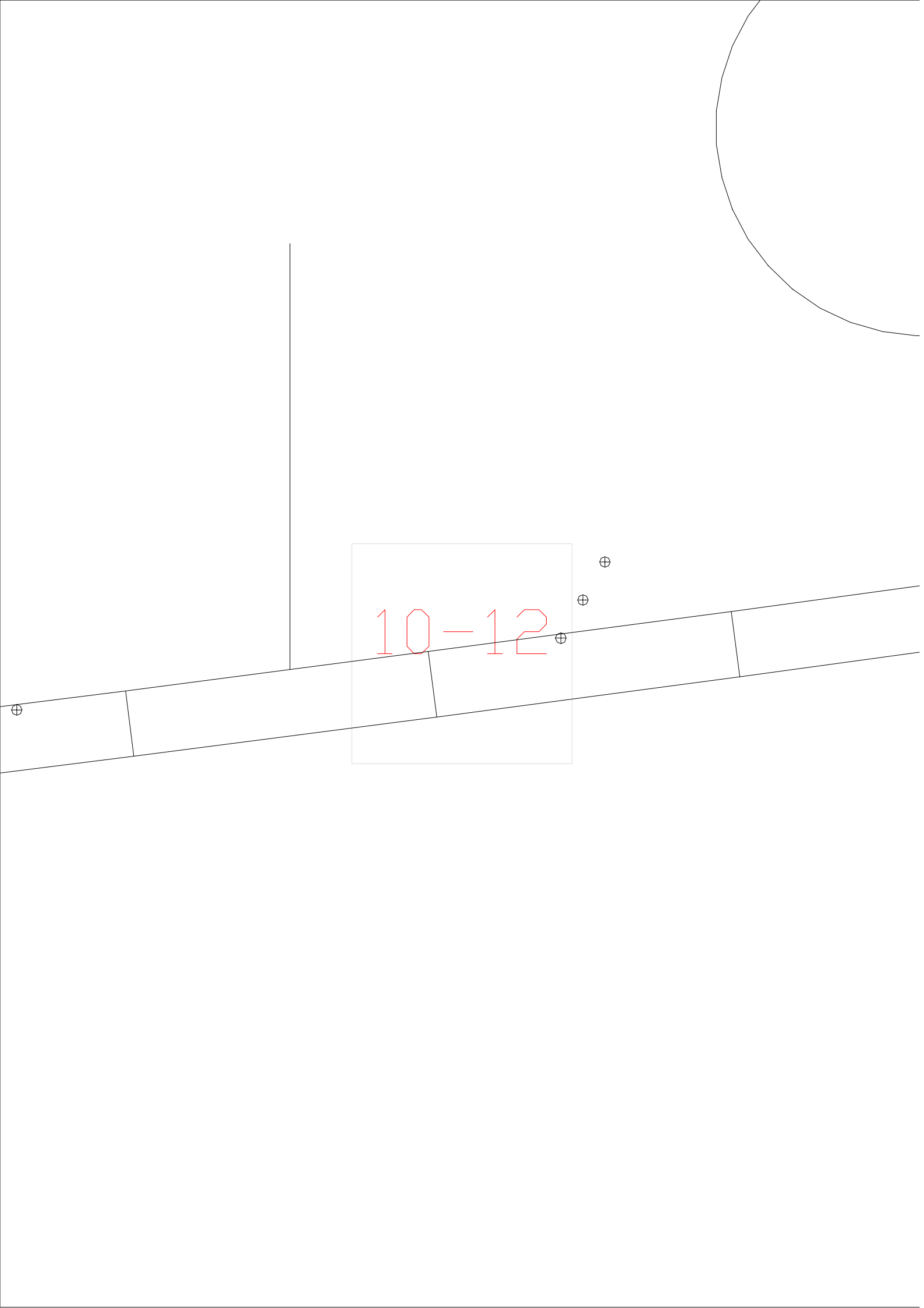

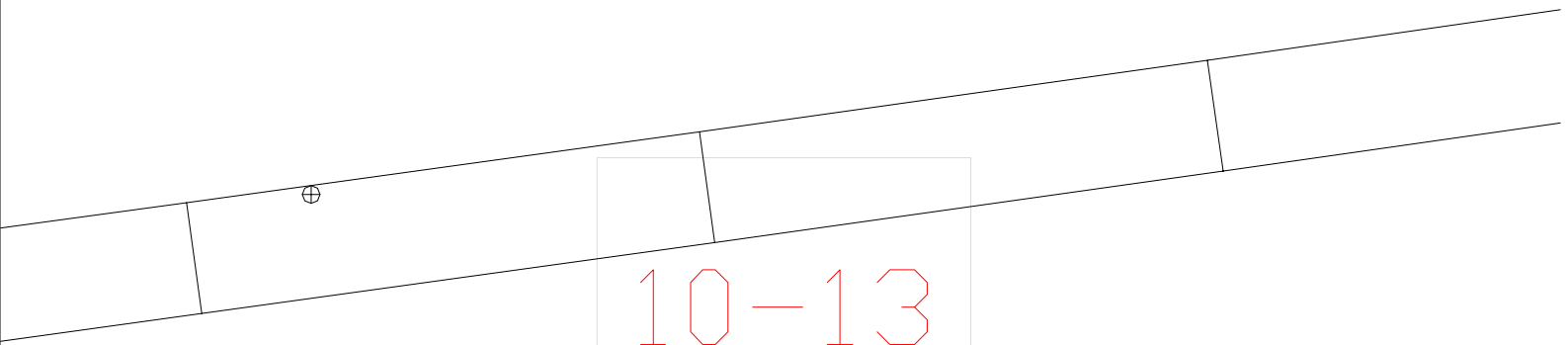
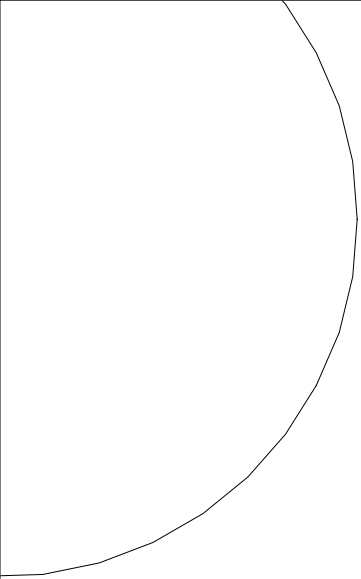

10-13

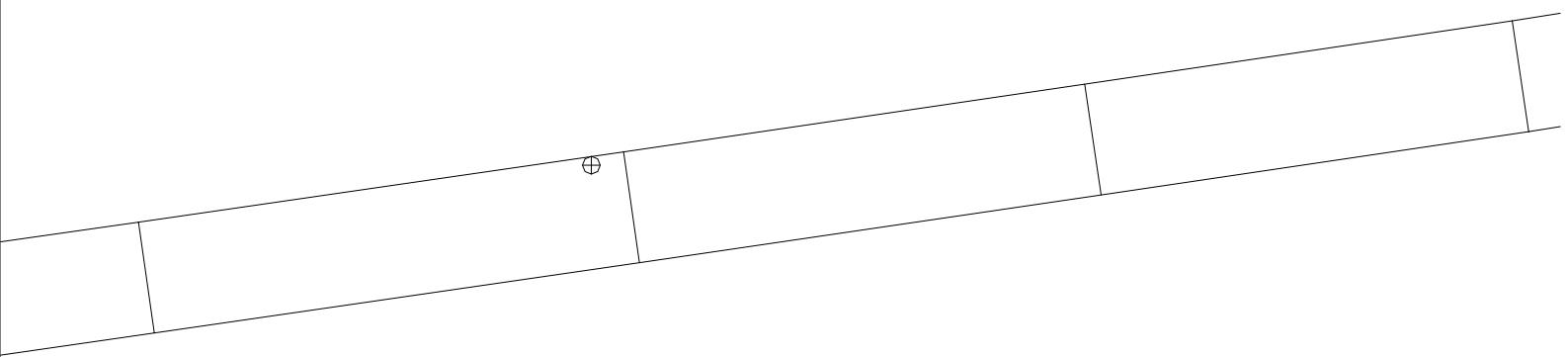
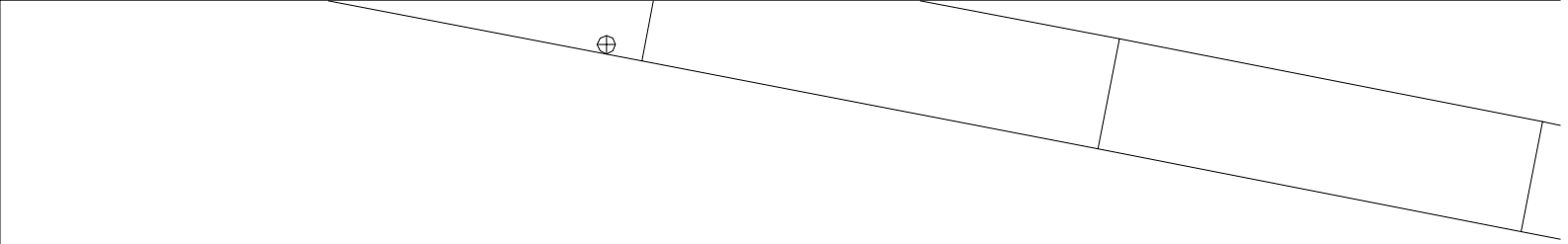

10-14

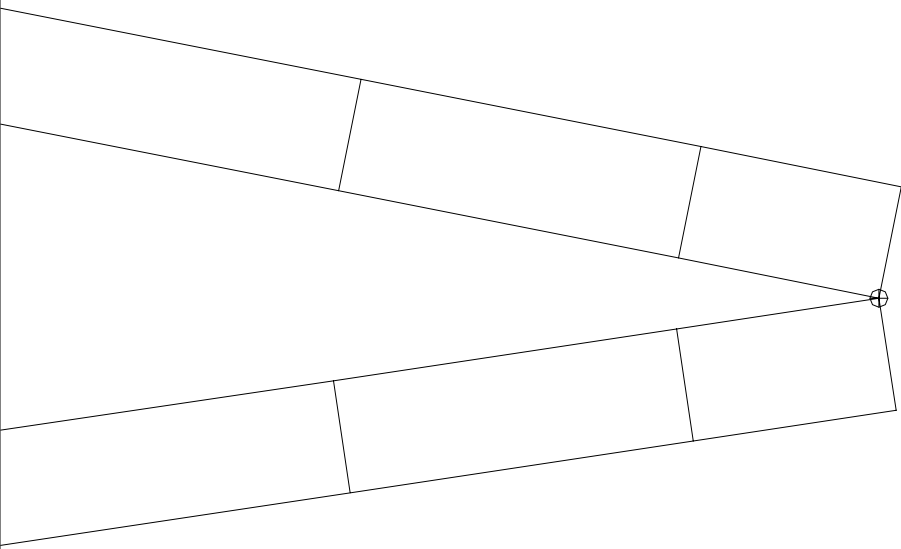

10-15

10-16

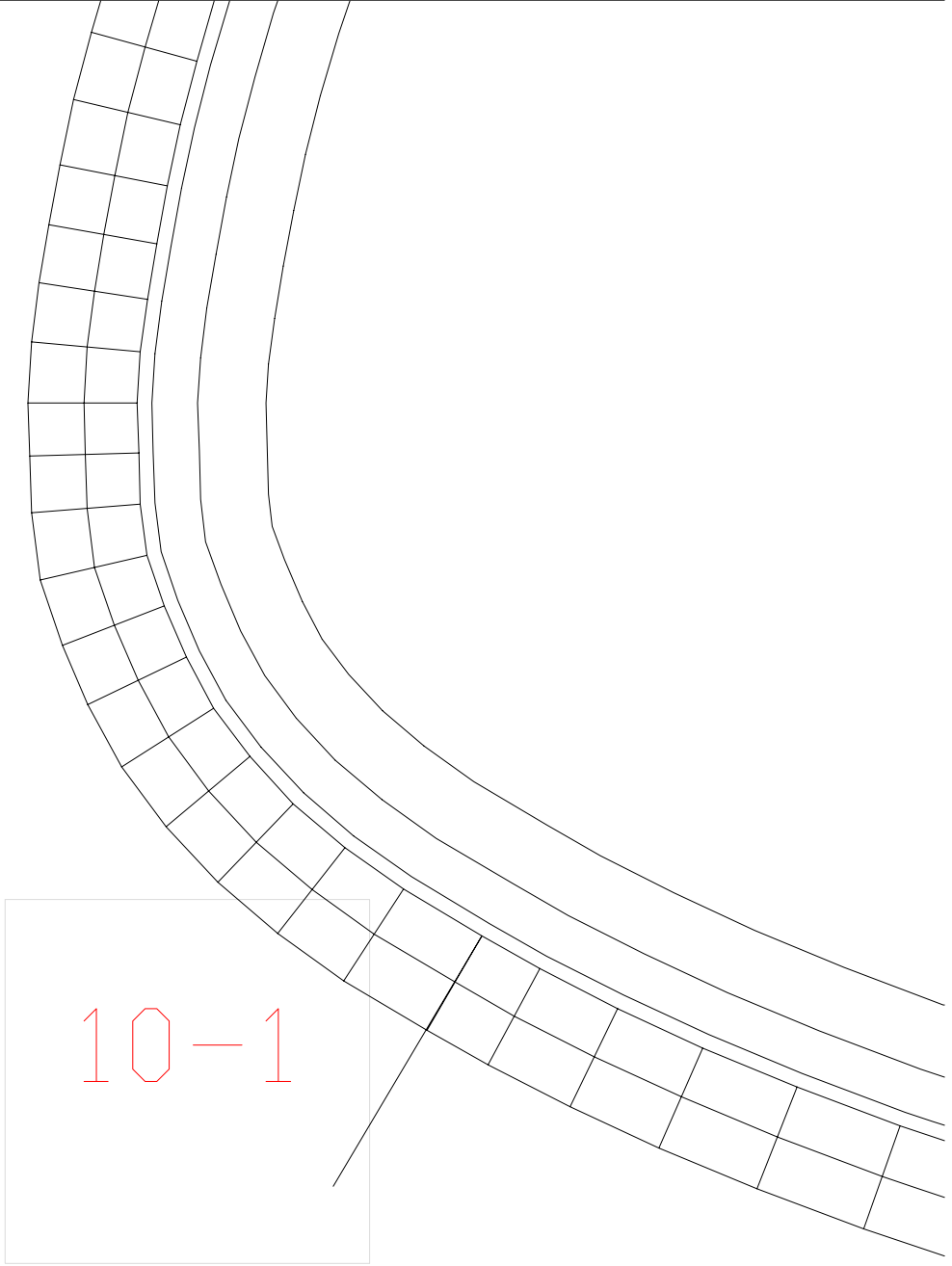

10-1

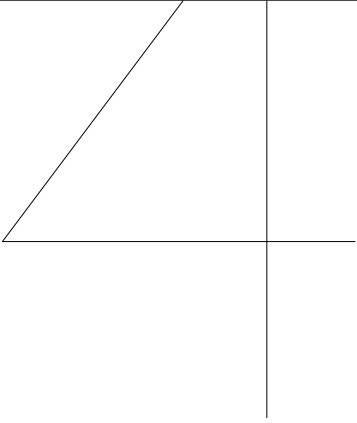

10-2

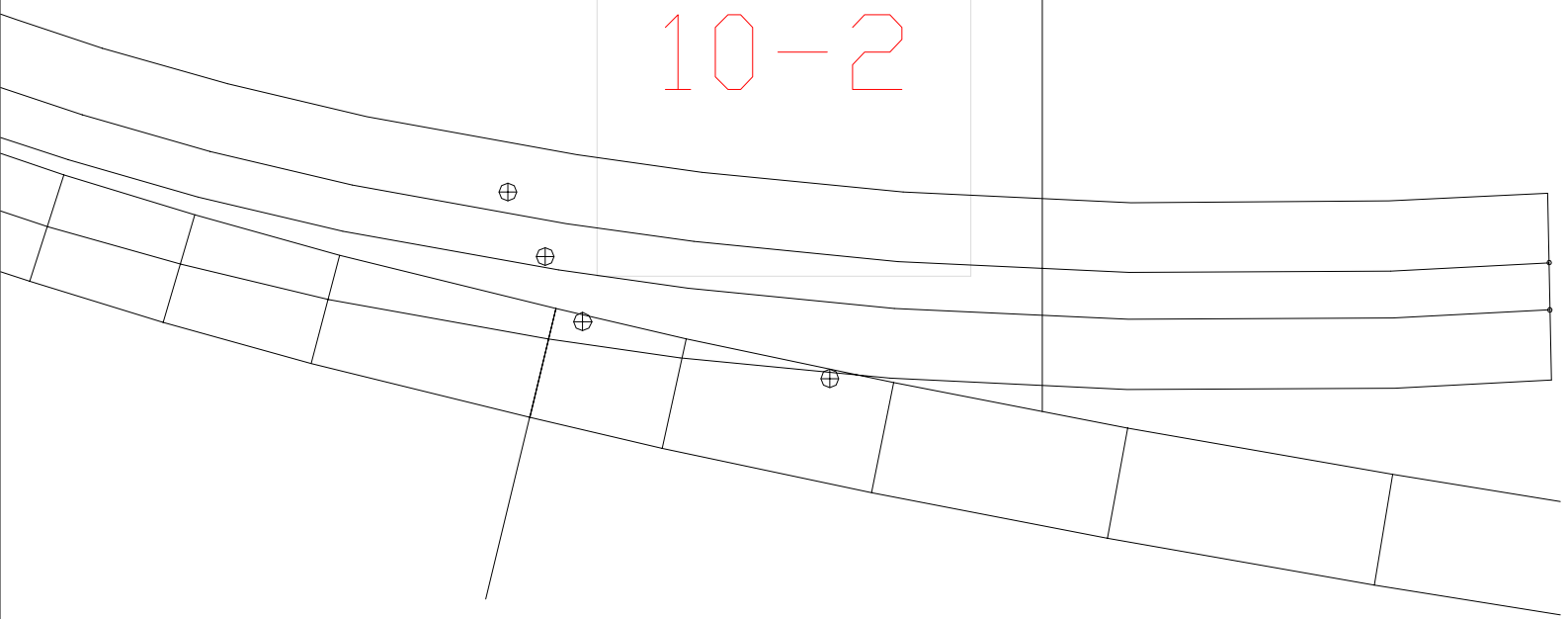

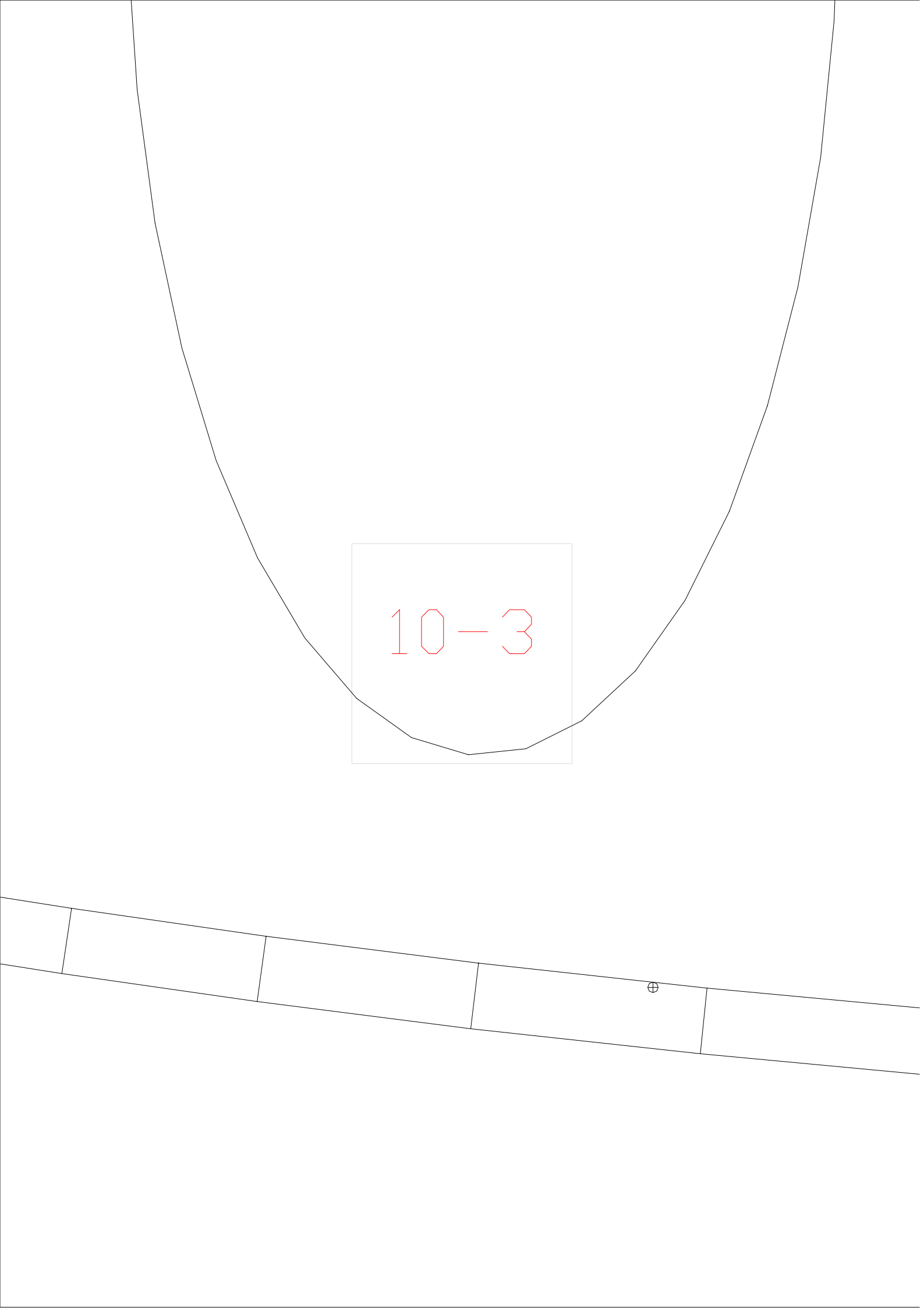

10-3

⊕

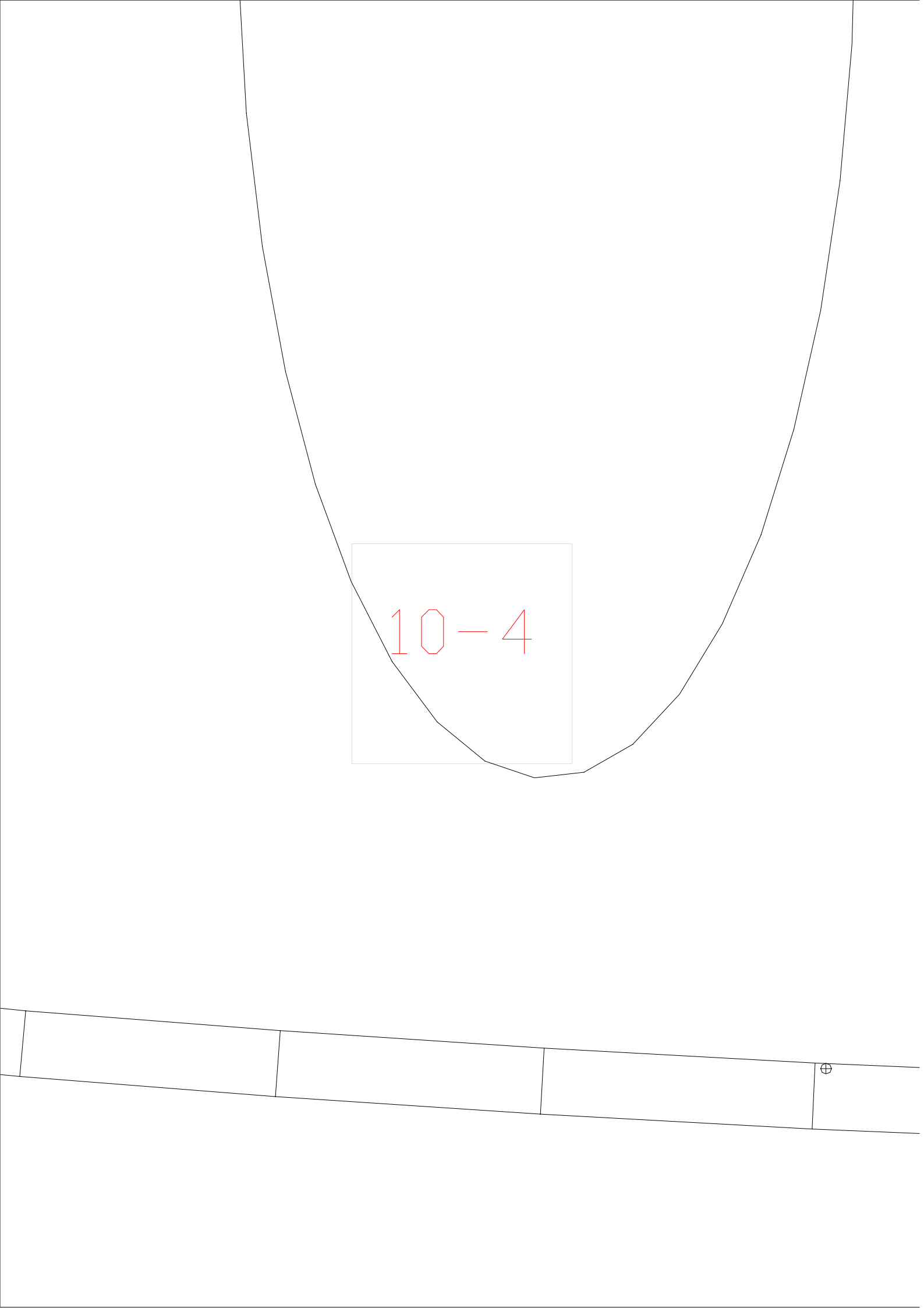

10-4

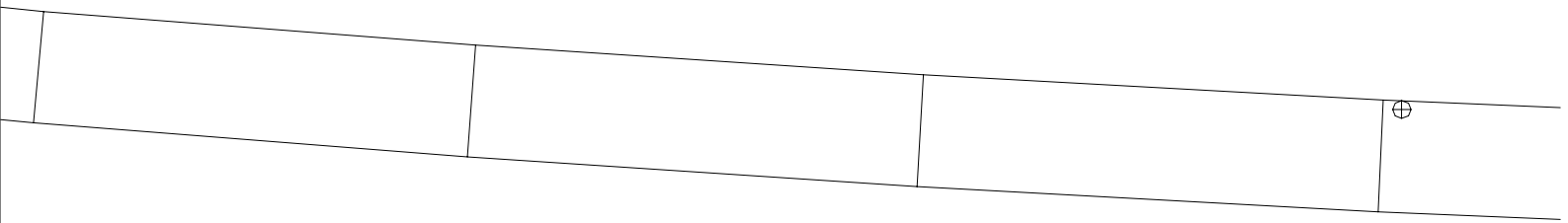

10-5

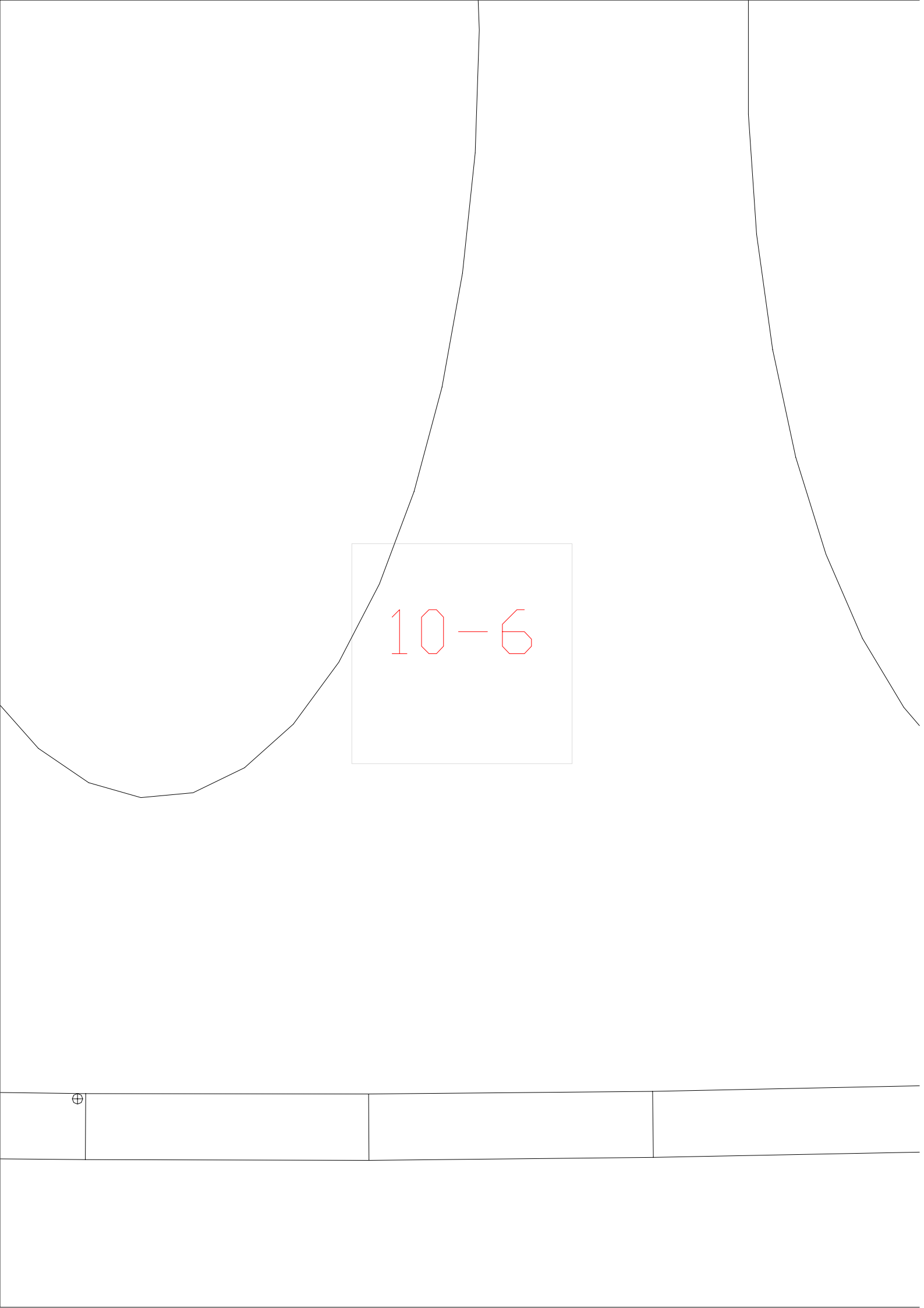

10-6

⊕

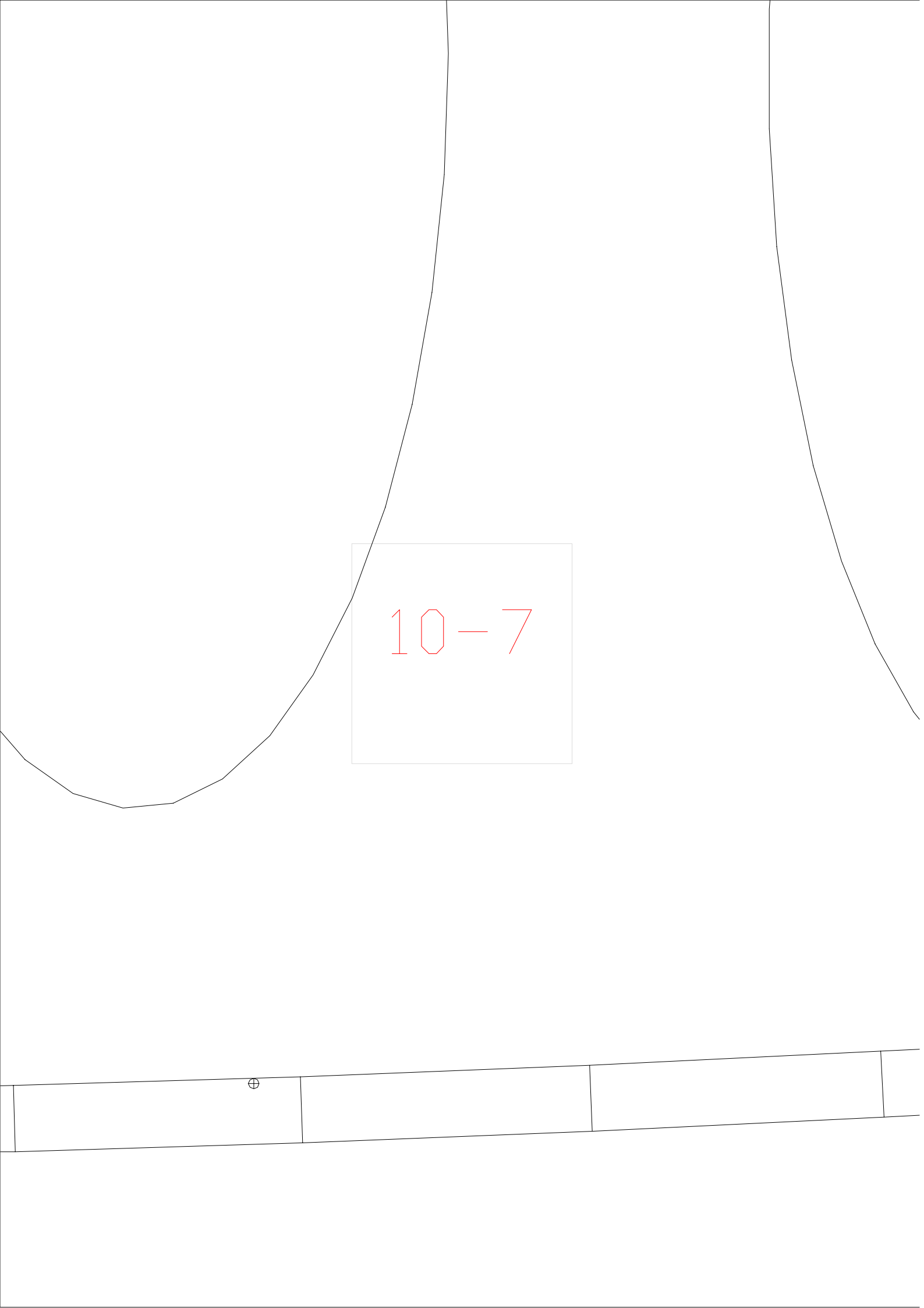

10-7

⊕

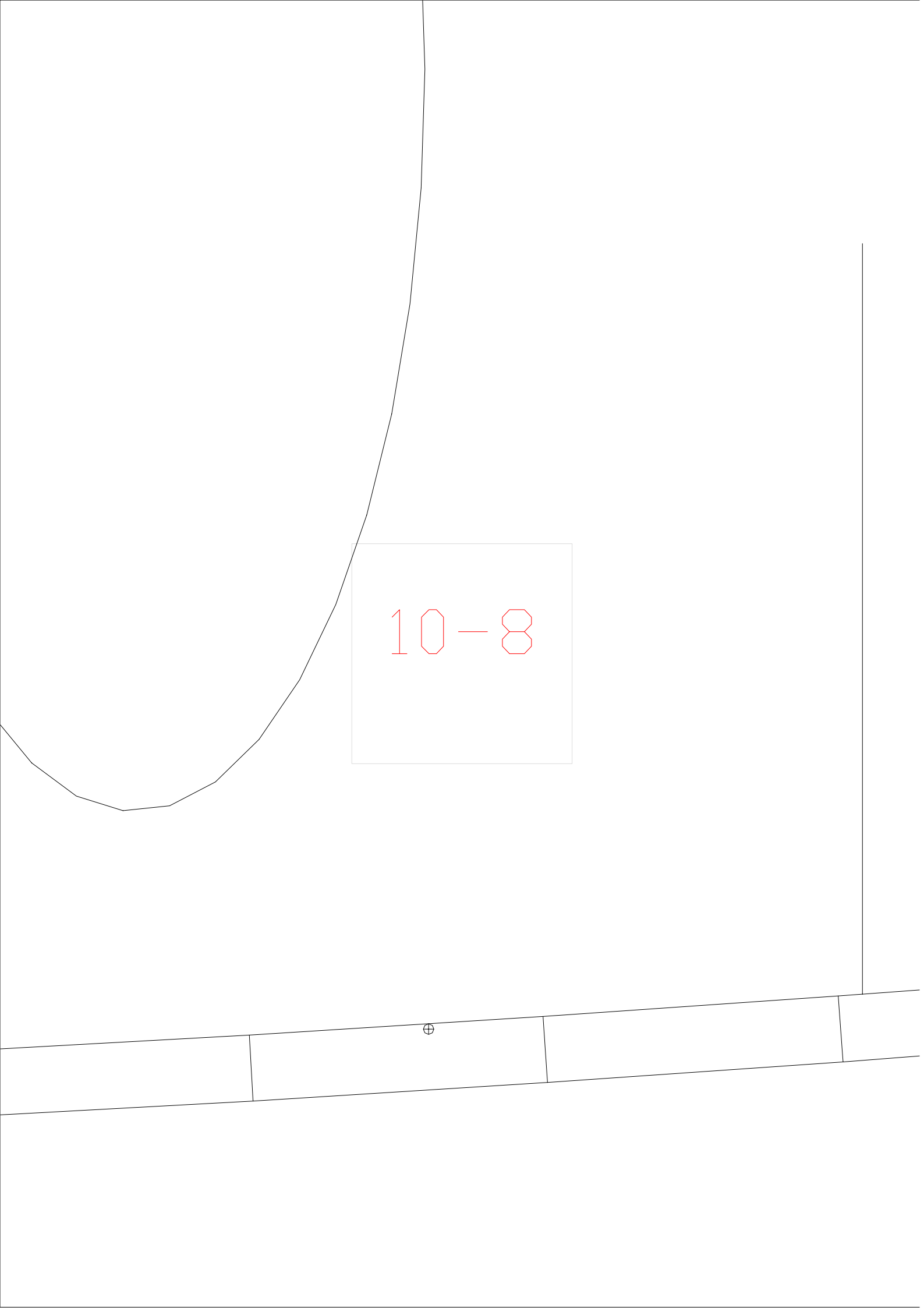

10-8

	⊕	

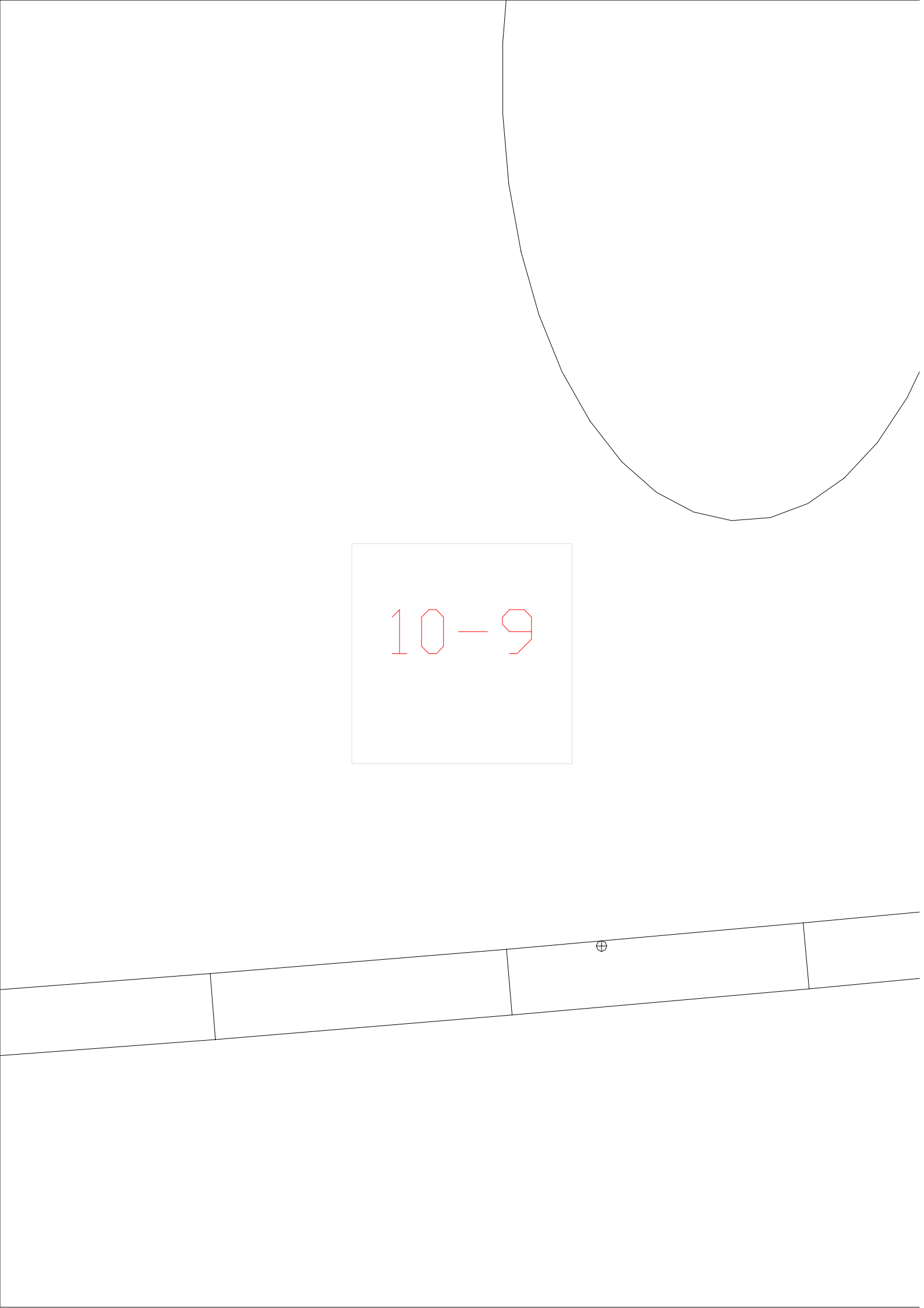

10-9

1-10

11-10

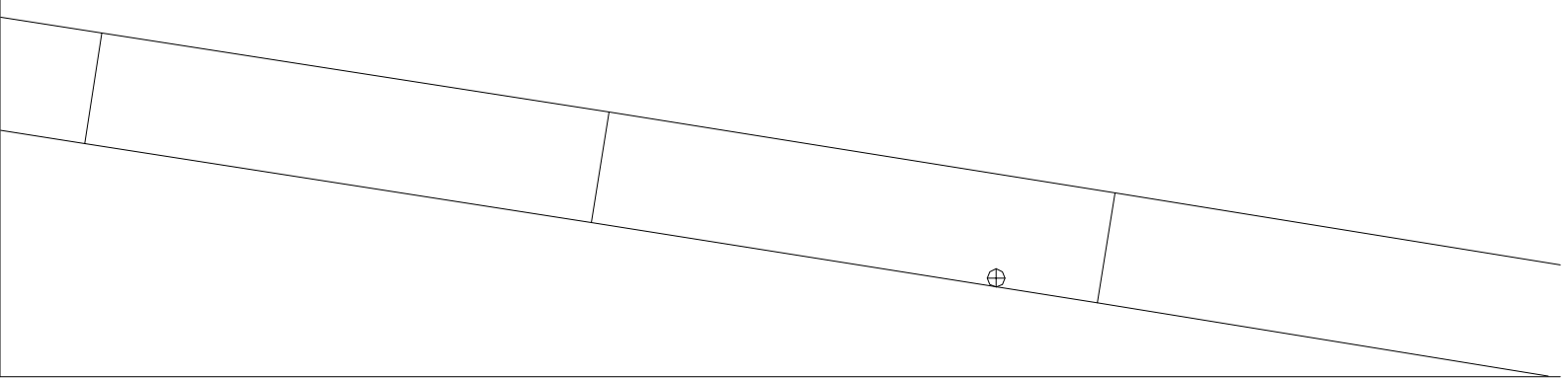

11-11

11-12

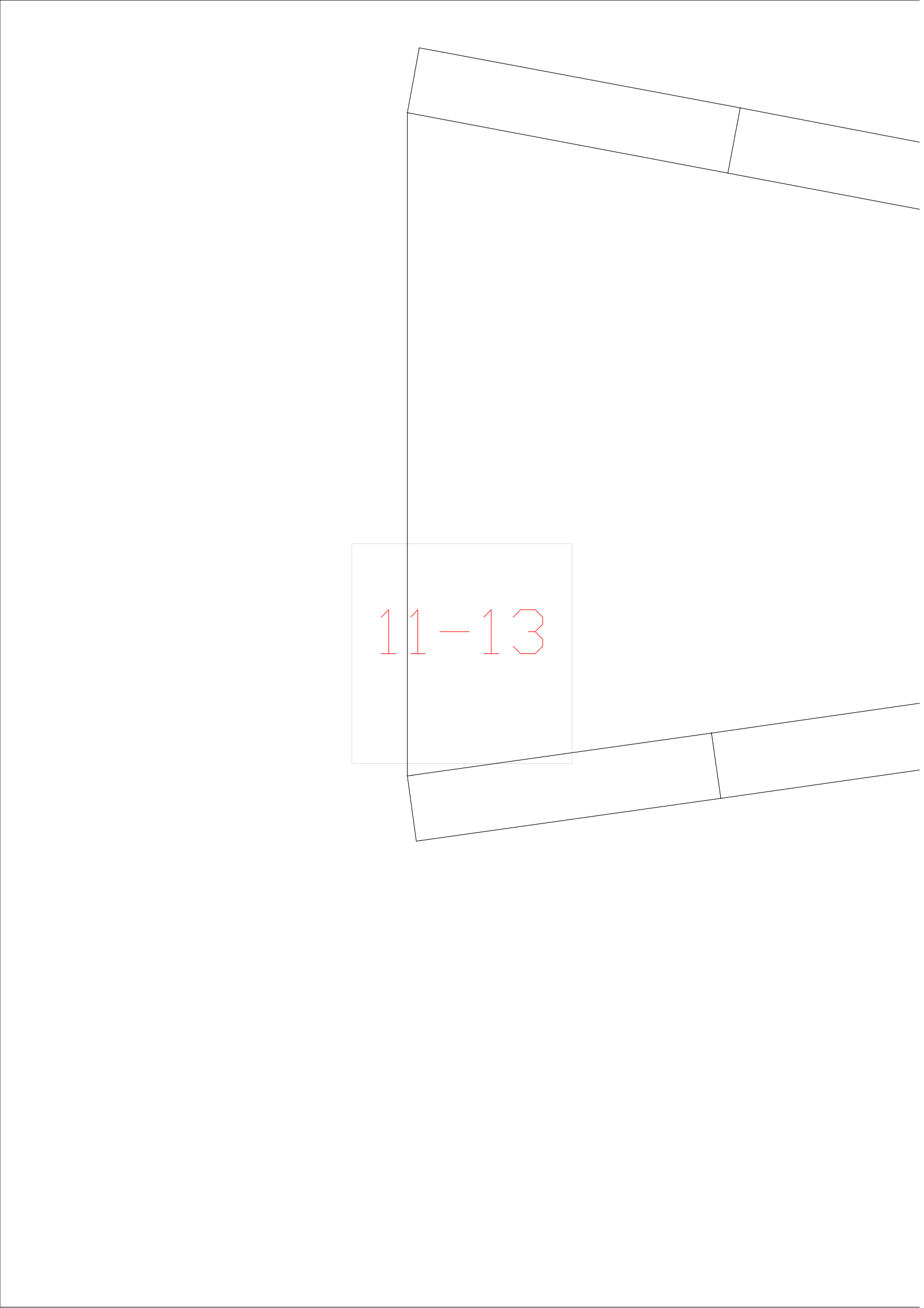

11-13

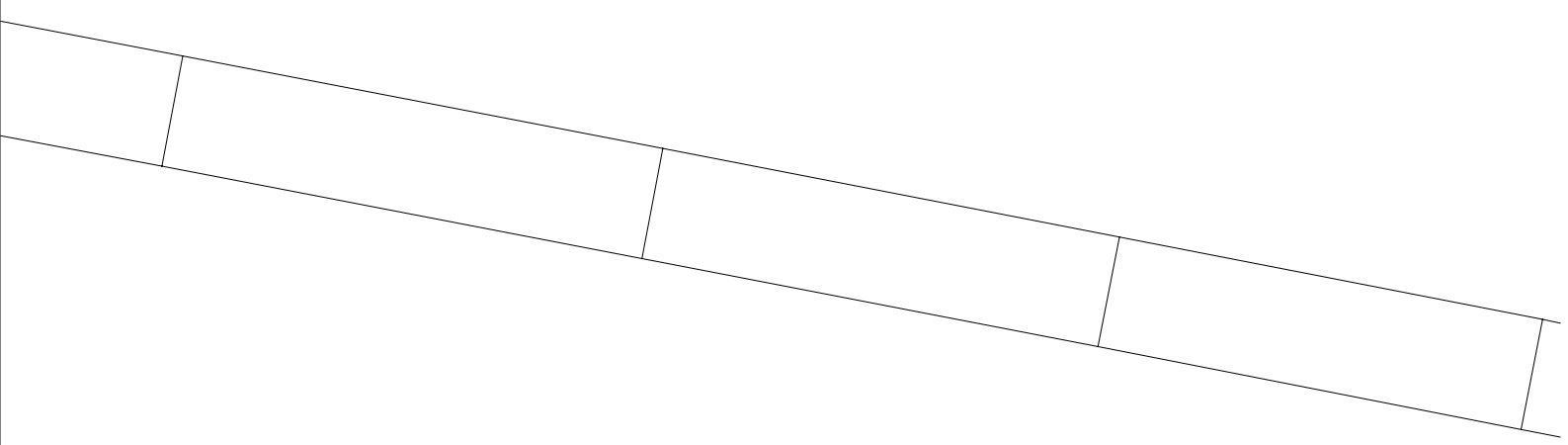

11-14

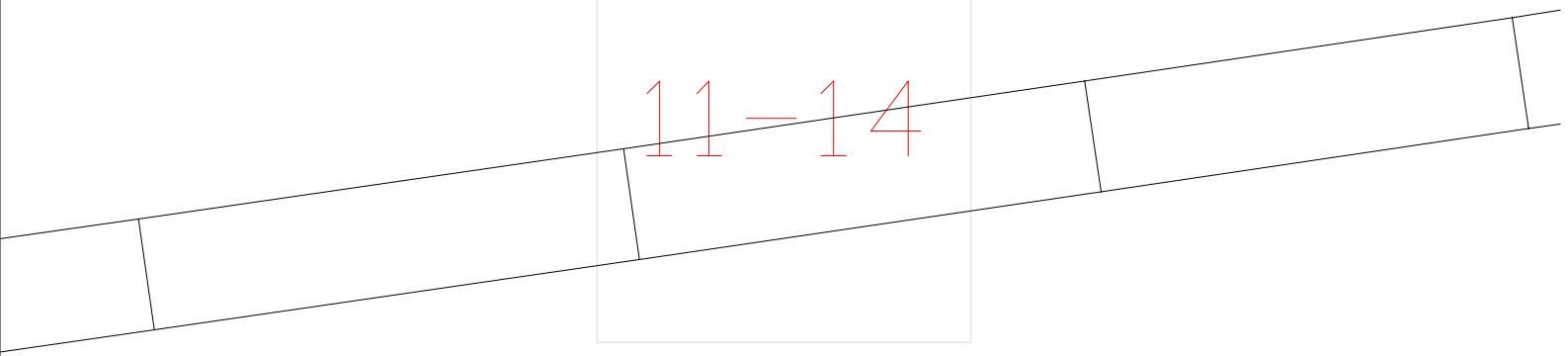

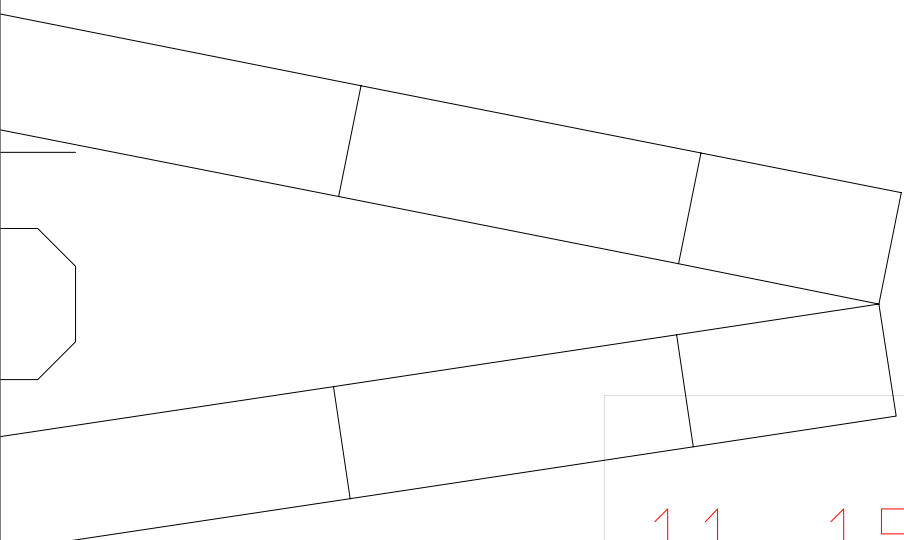

11-15

11-16

1 - 11

11-1

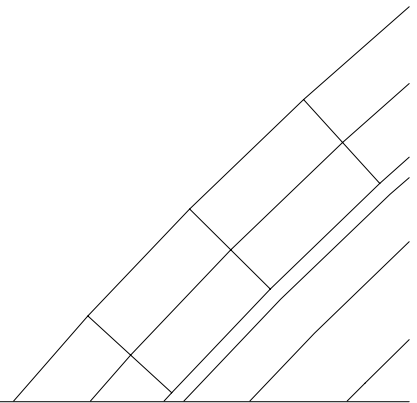

1-12

11-2

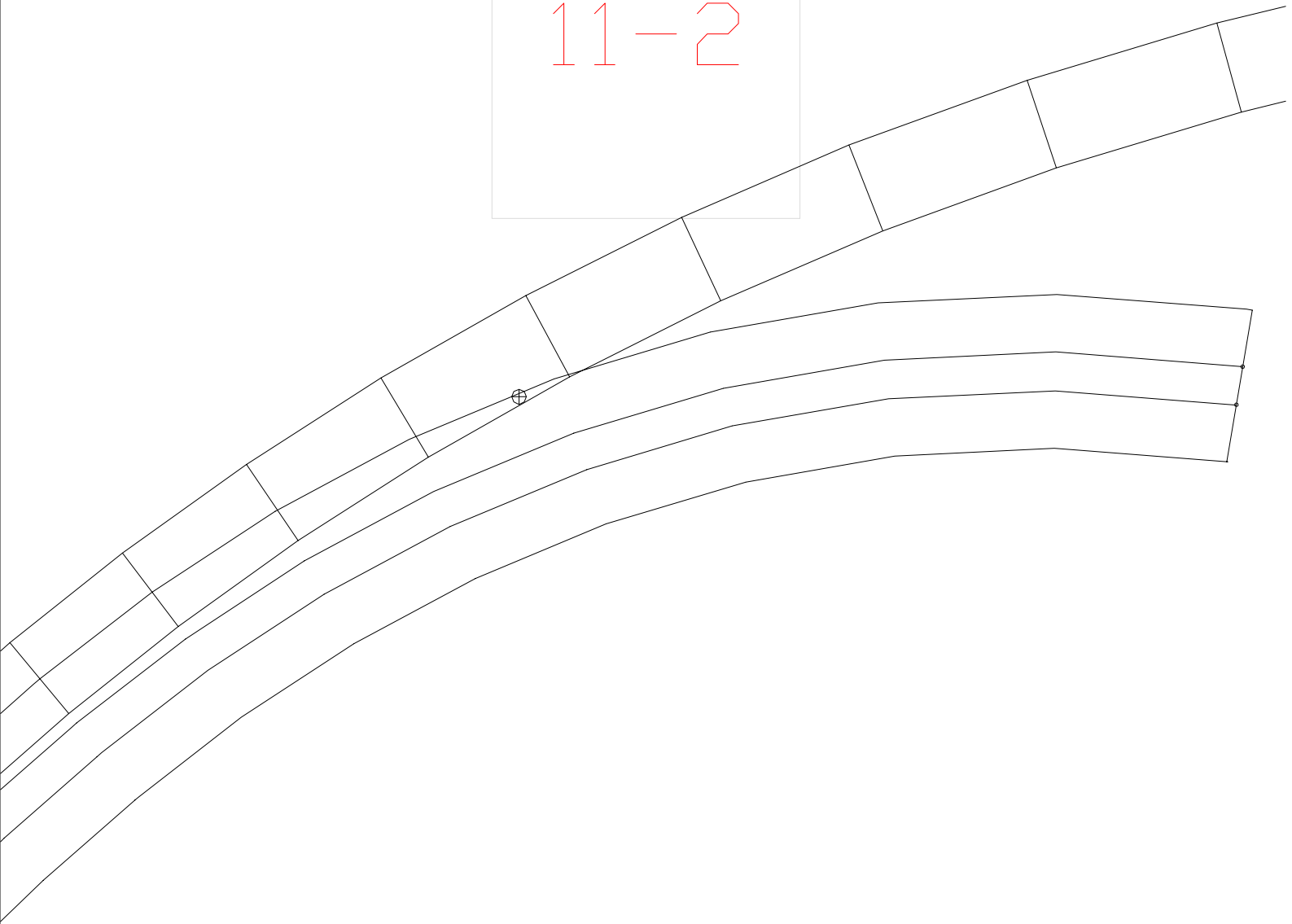

1-13

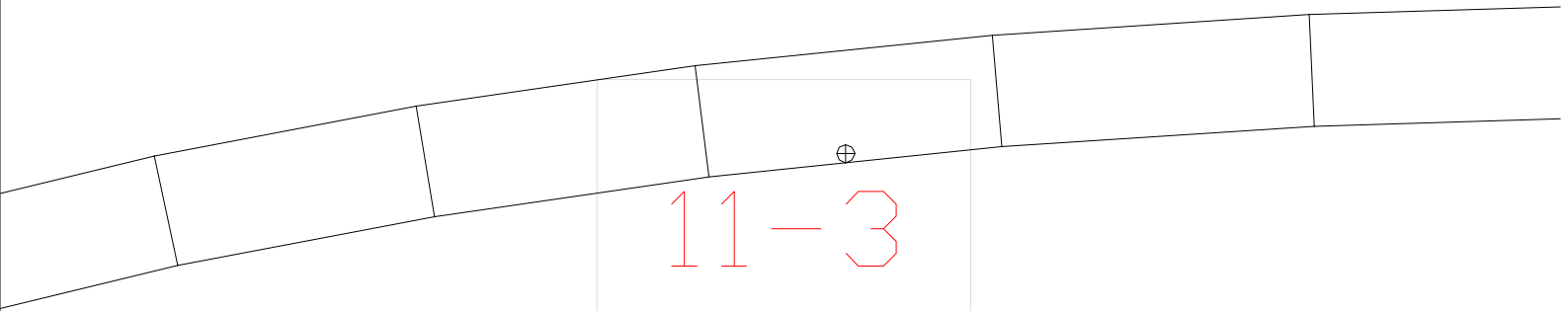

11-3

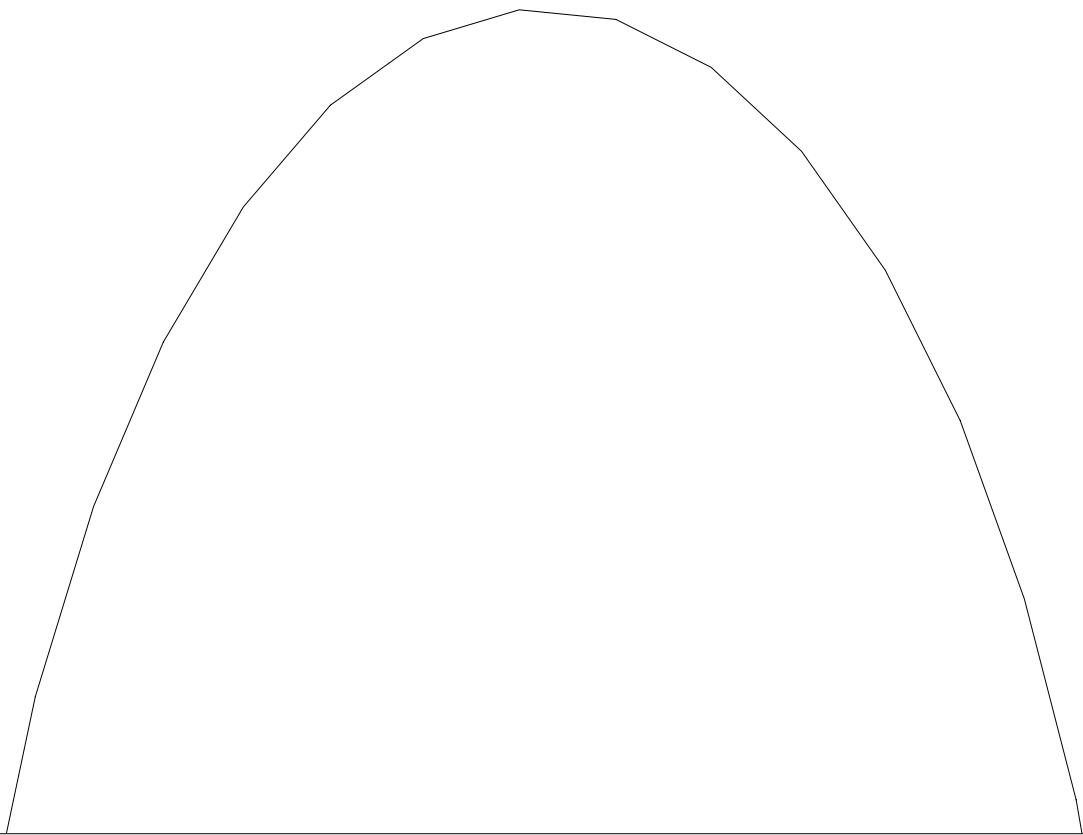

1-14

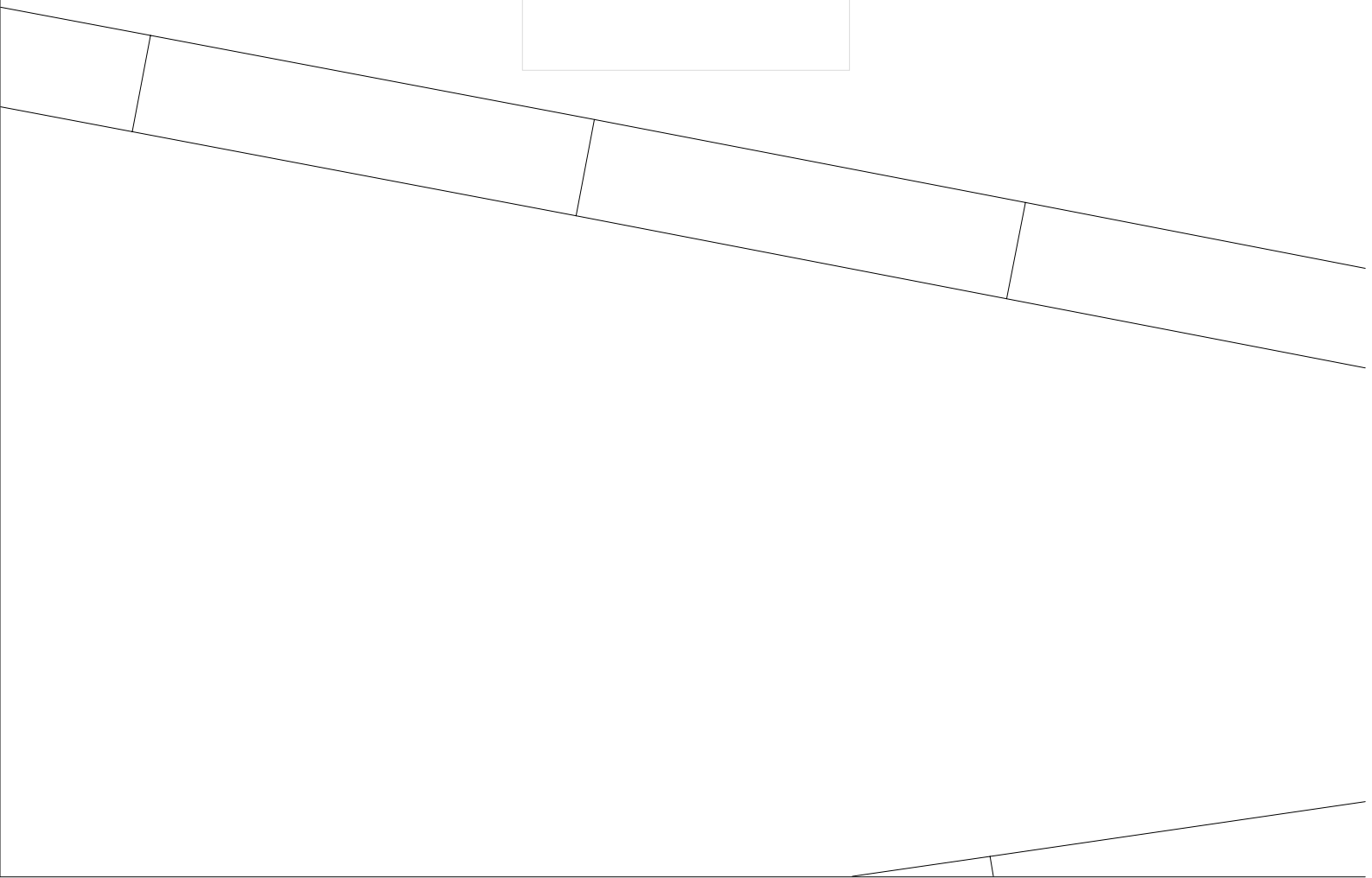

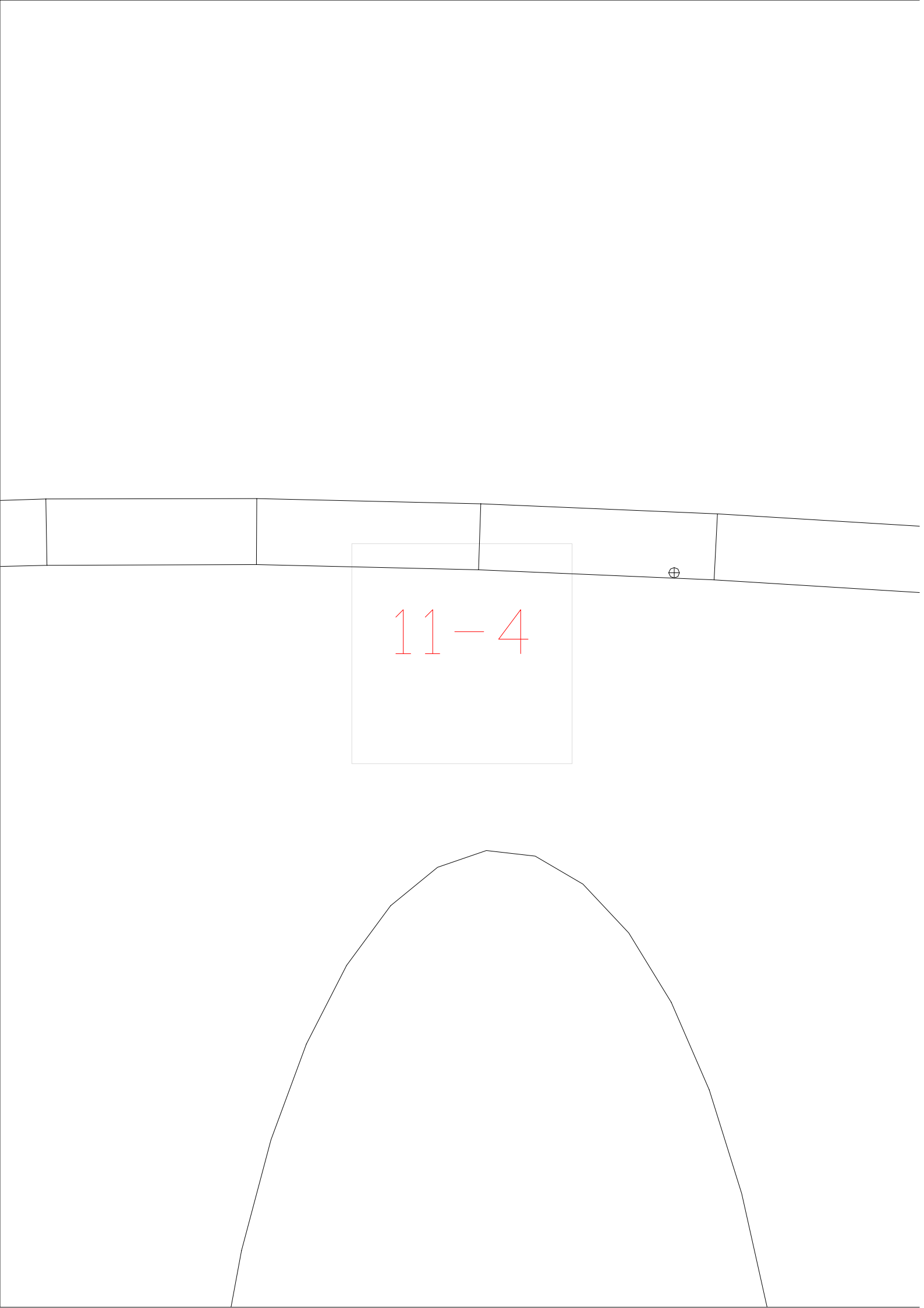

11-4

The image shows a technical drawing of a dome. A horizontal section line is drawn across the upper part of the dome, with a small circle containing a cross symbol (⊕) on the right side. A rectangular callout box is positioned below the section line, containing the text '11-4' in red. The dome's profile is shown as a series of connected line segments forming a smooth curve.

1-15

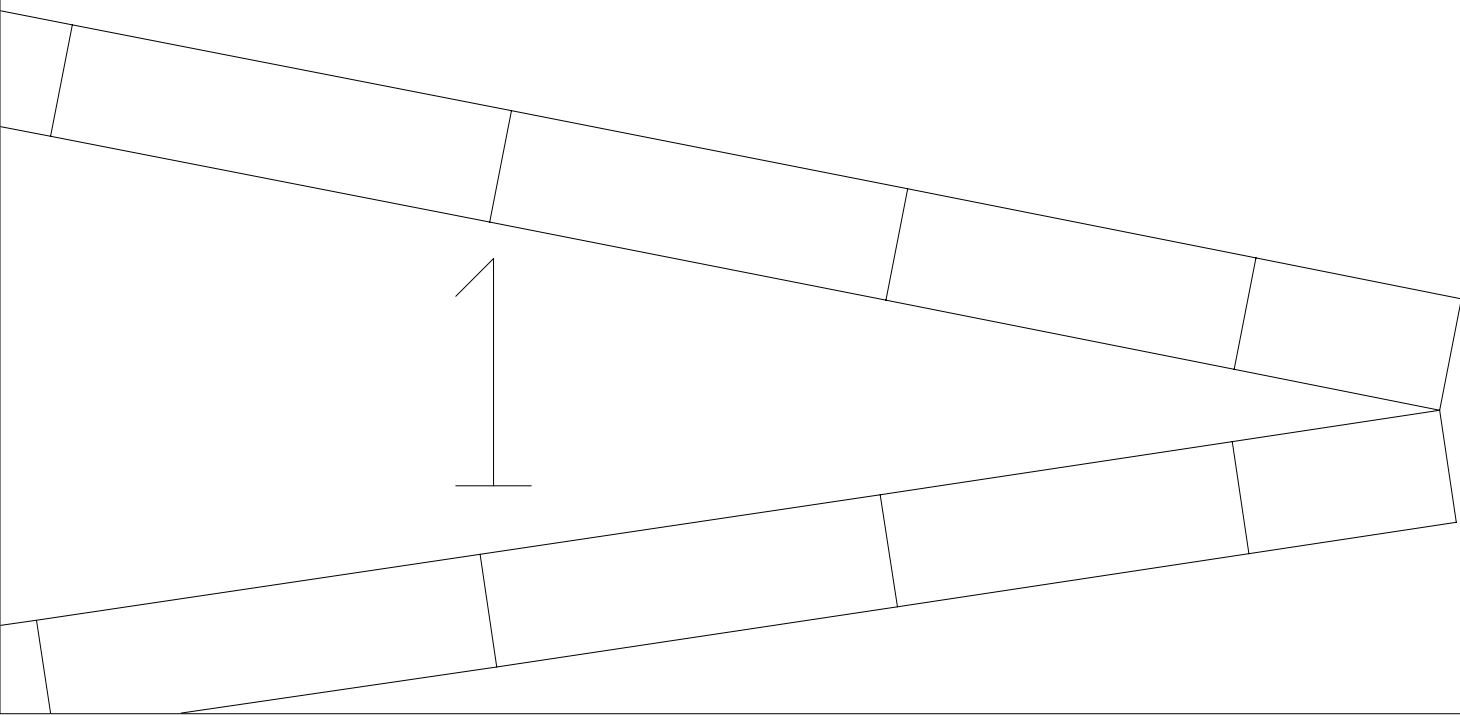

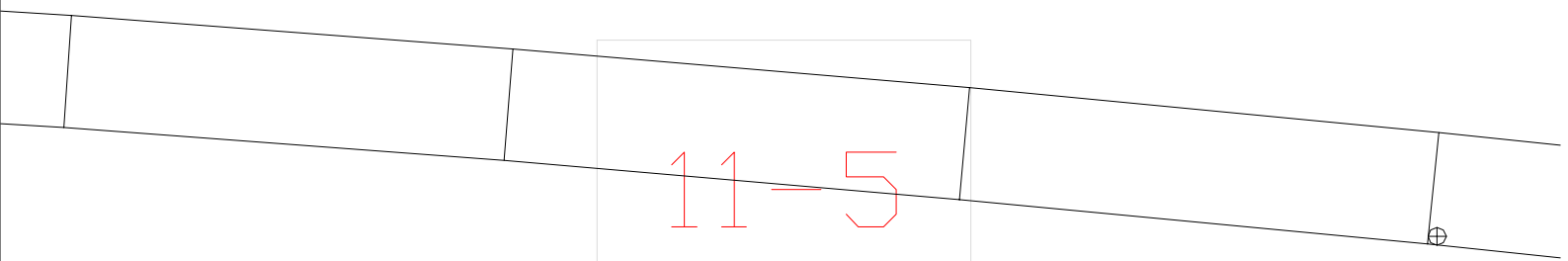

11-5

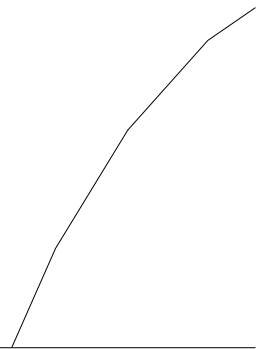

1-16

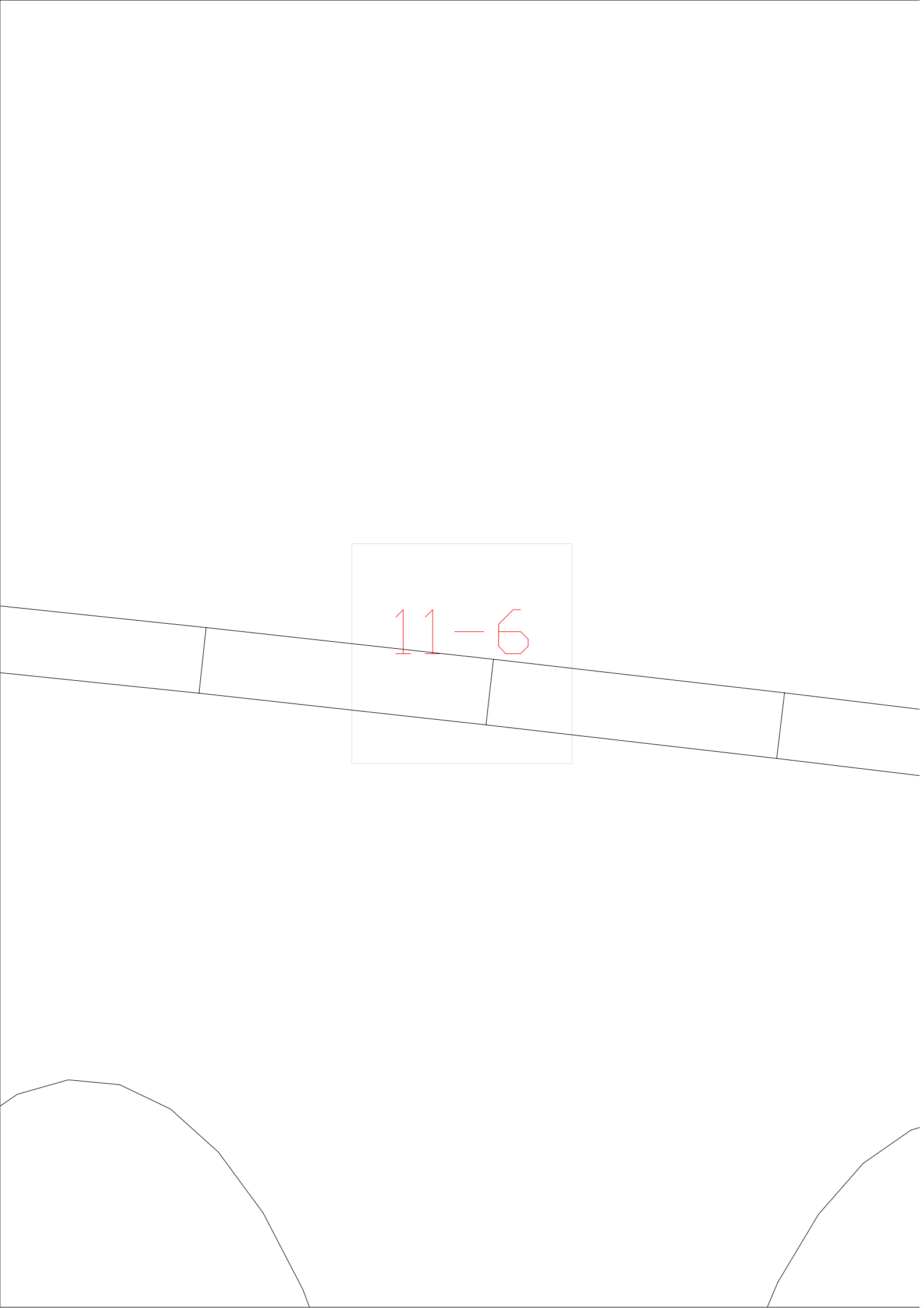

11-6

11-7

⊕

11-8

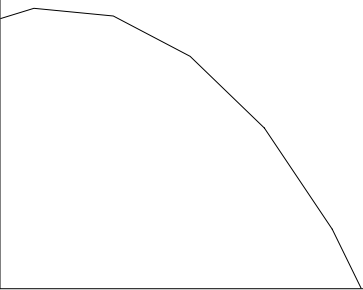
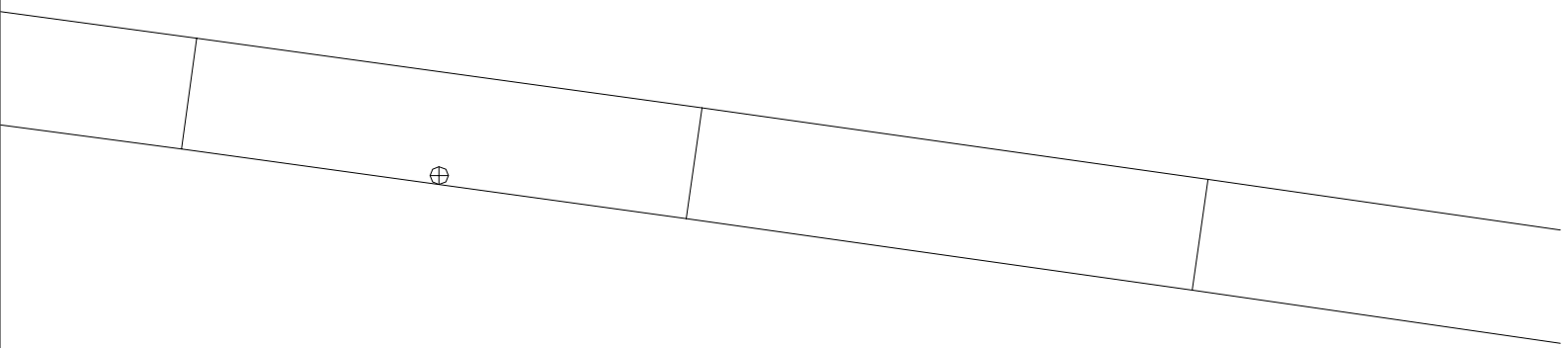

11-9

⊕

1 - 1

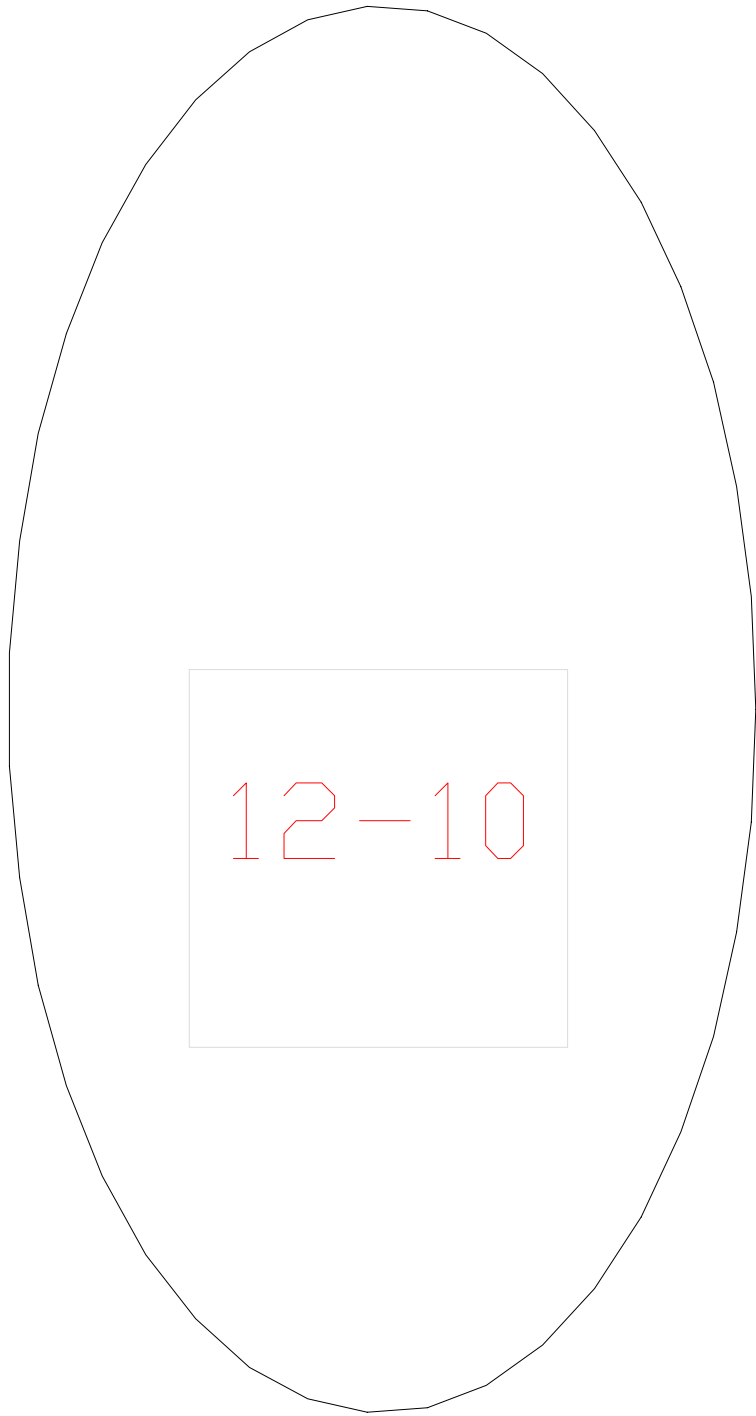

12-10

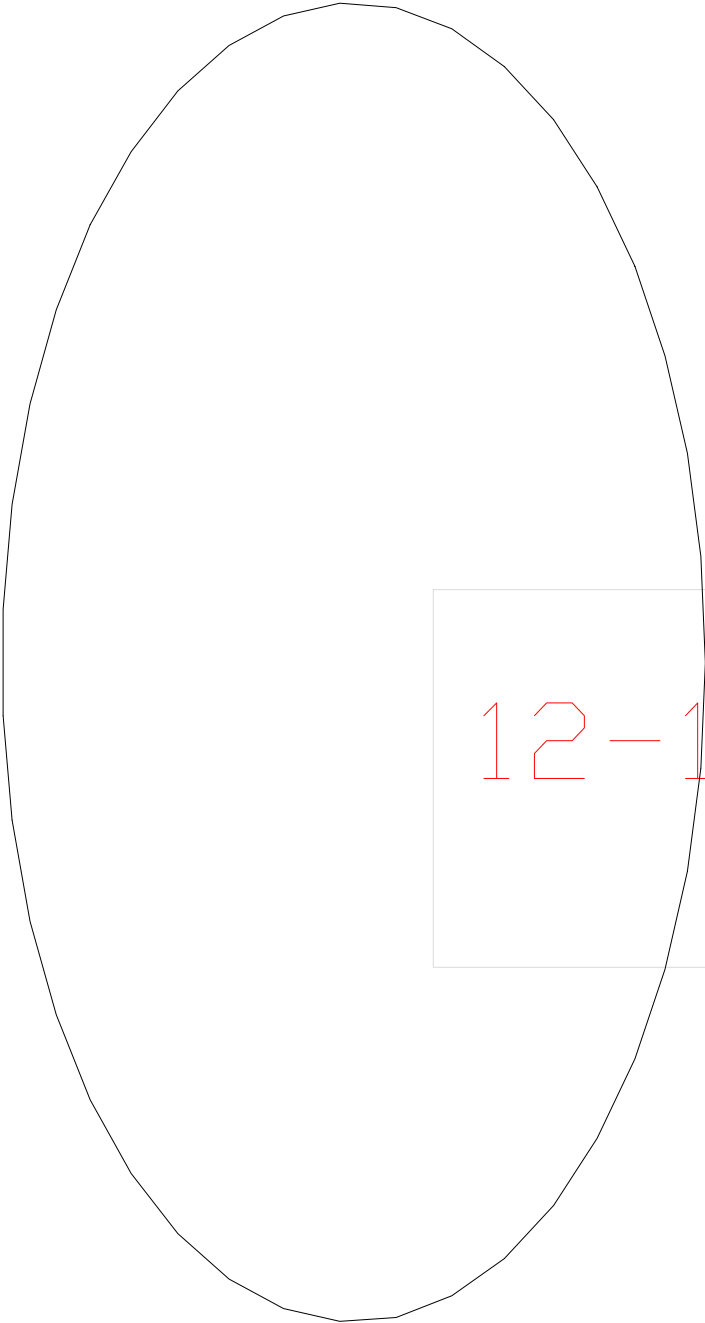

12-11



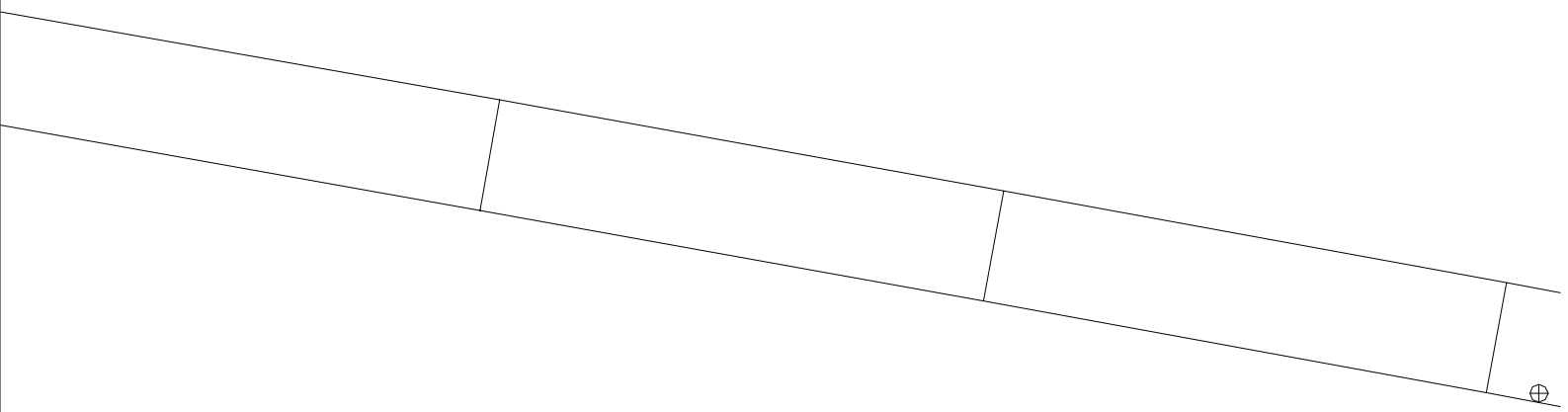

12-12

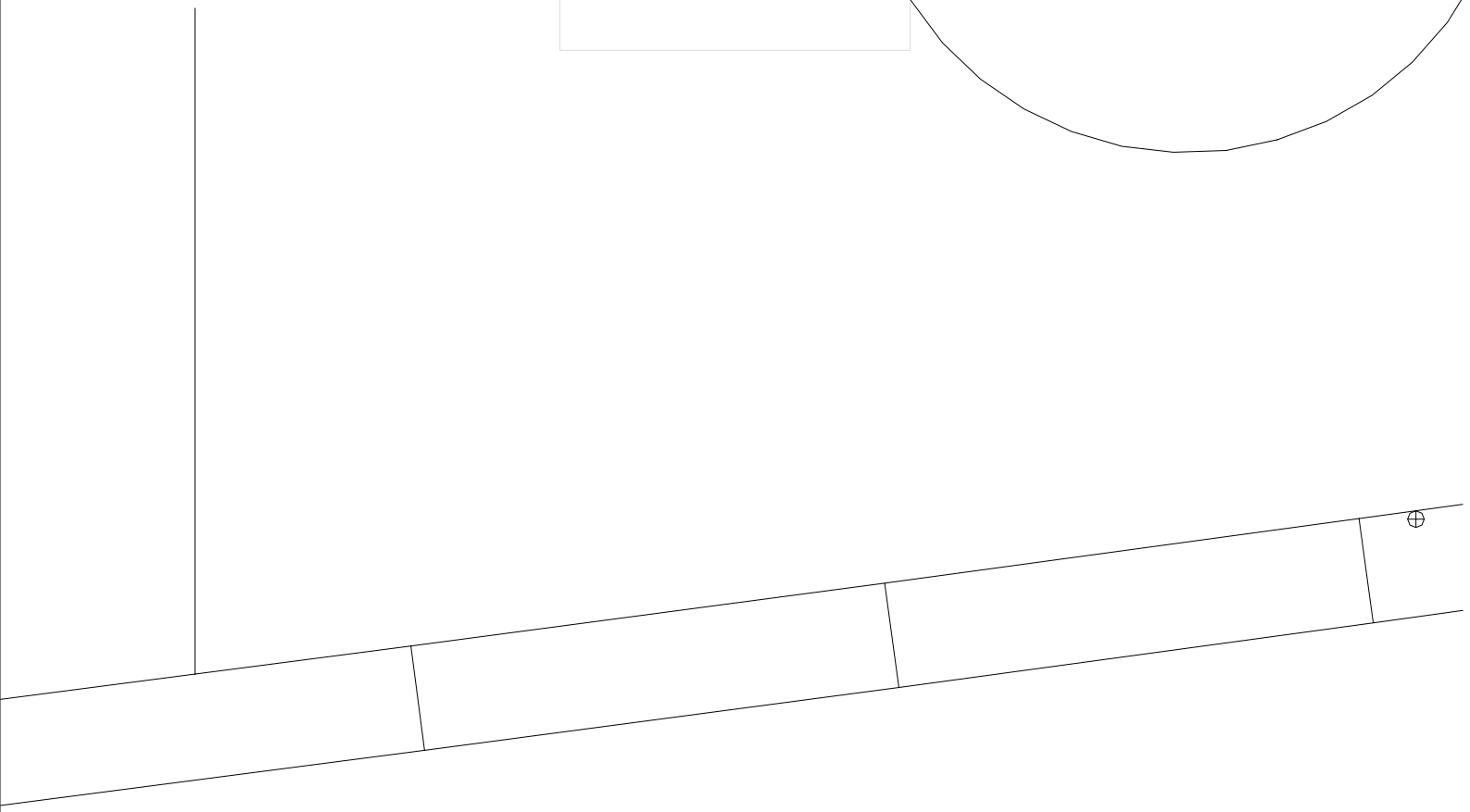
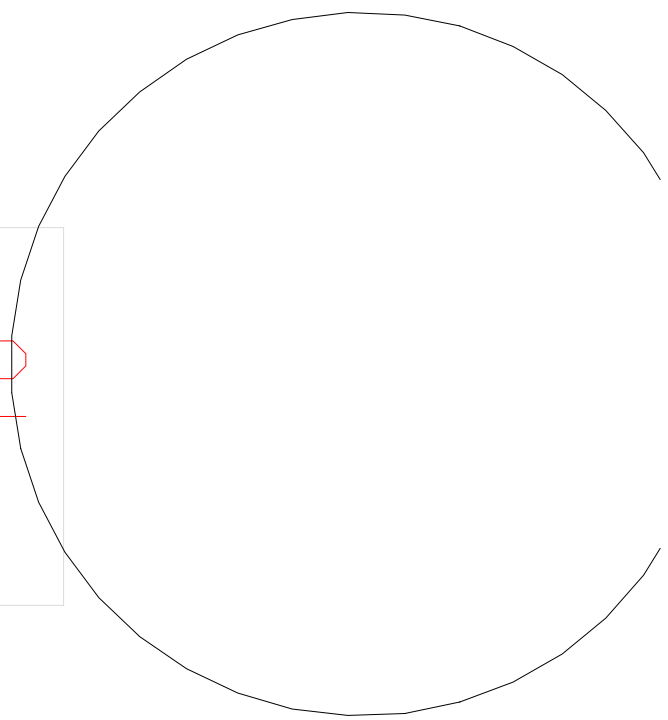



12-13

The image shows a technical drawing of a tapered shaft. The shaft is oriented horizontally and tapers from left to right. It is divided into four segments by three vertical lines. A central rectangular box contains the text '12-13' in red. The drawing is set against a white background with a vertical line on the left side and a curved line on the far left edge.

12-14

The diagram shows a curved structure, possibly a pipe or duct, divided into several segments by vertical lines. A central rectangular box contains the text '12-14' in red. Two circular markers with a plus sign inside are located on the left side of the structure, one on the upper curve and one on the lower curve.

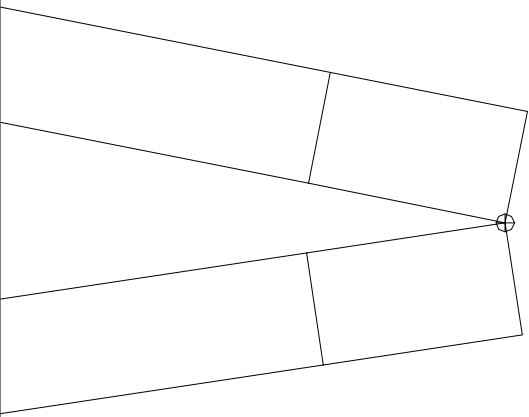

12-15

12-16

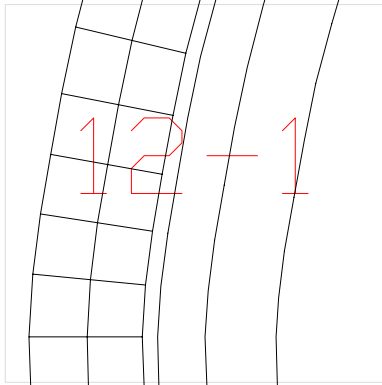

12-1

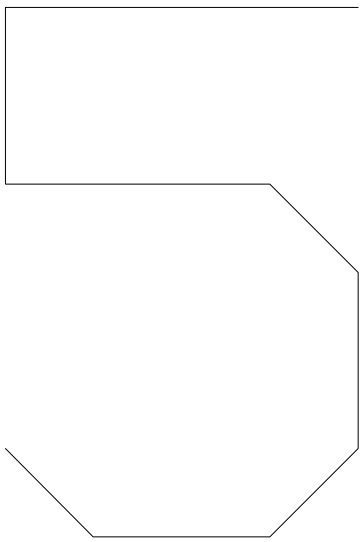

12-2

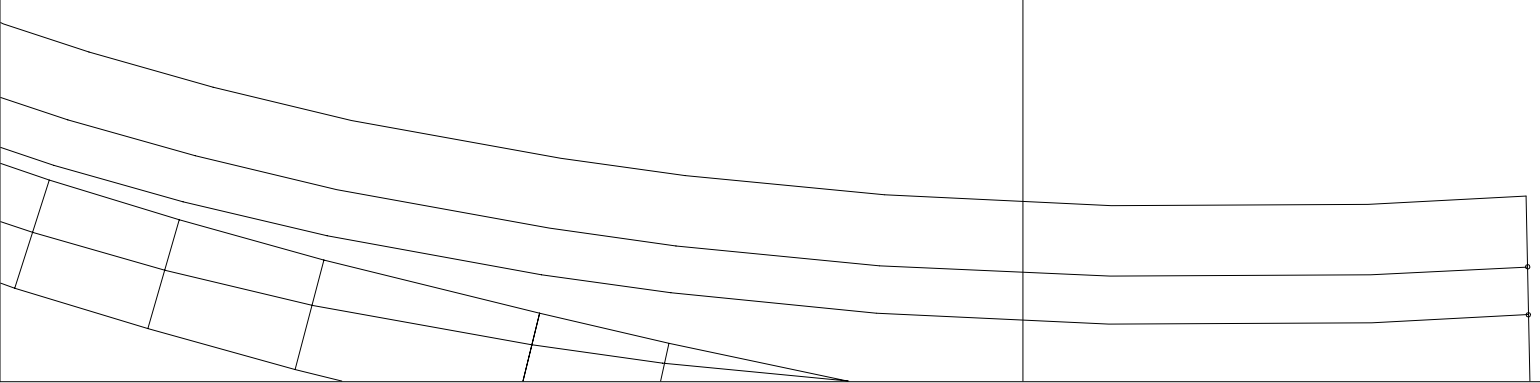

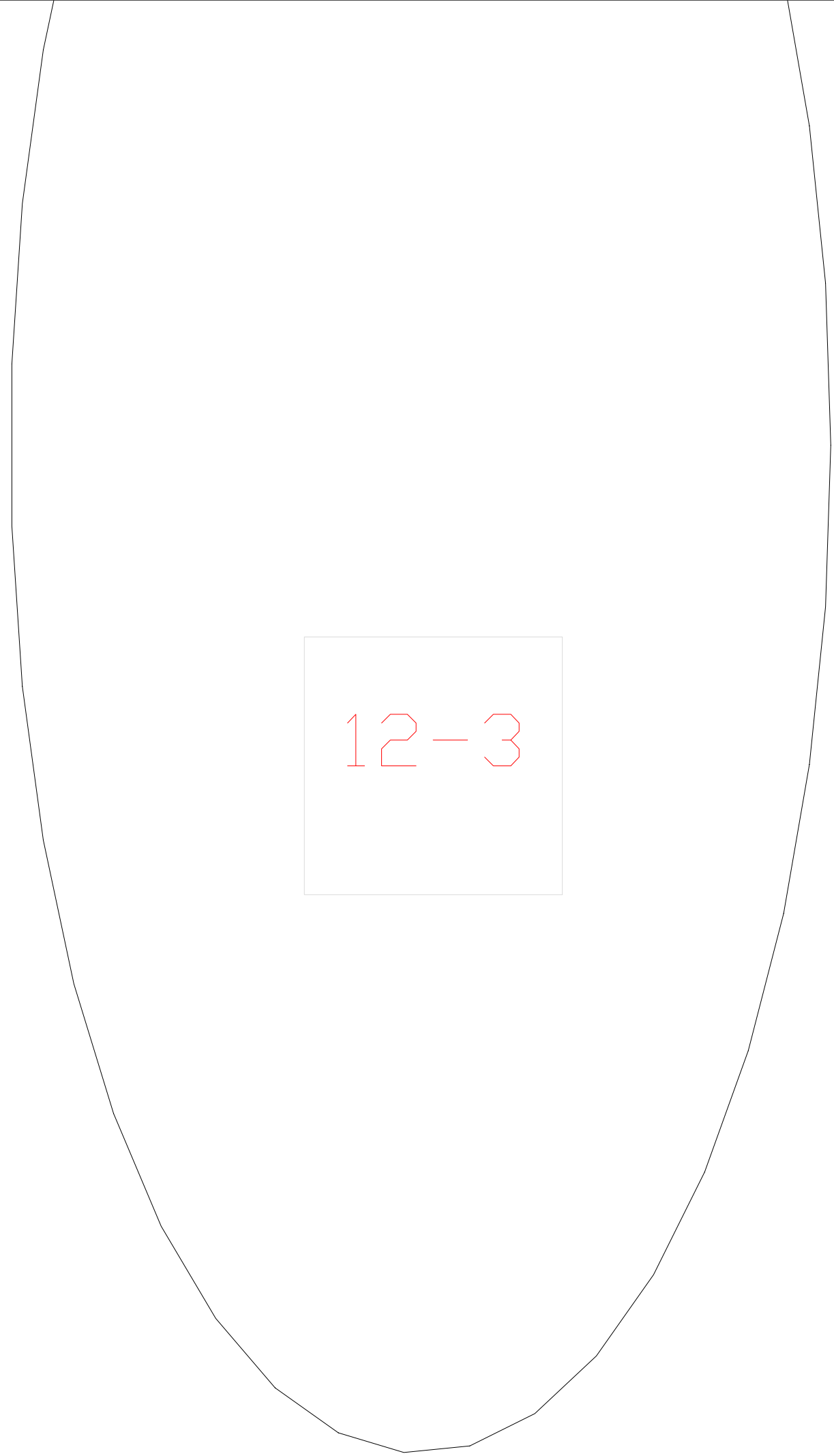

12-3

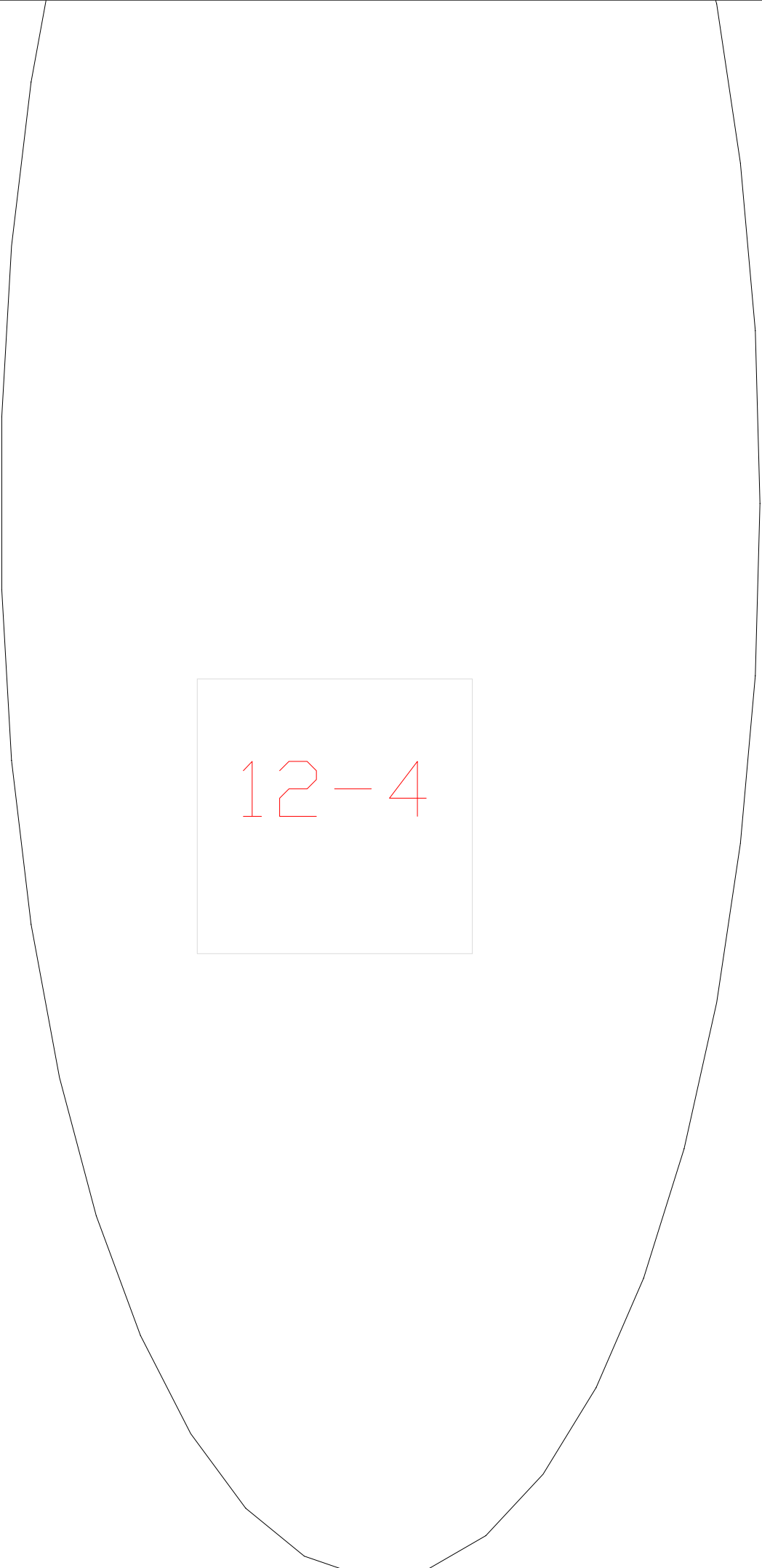

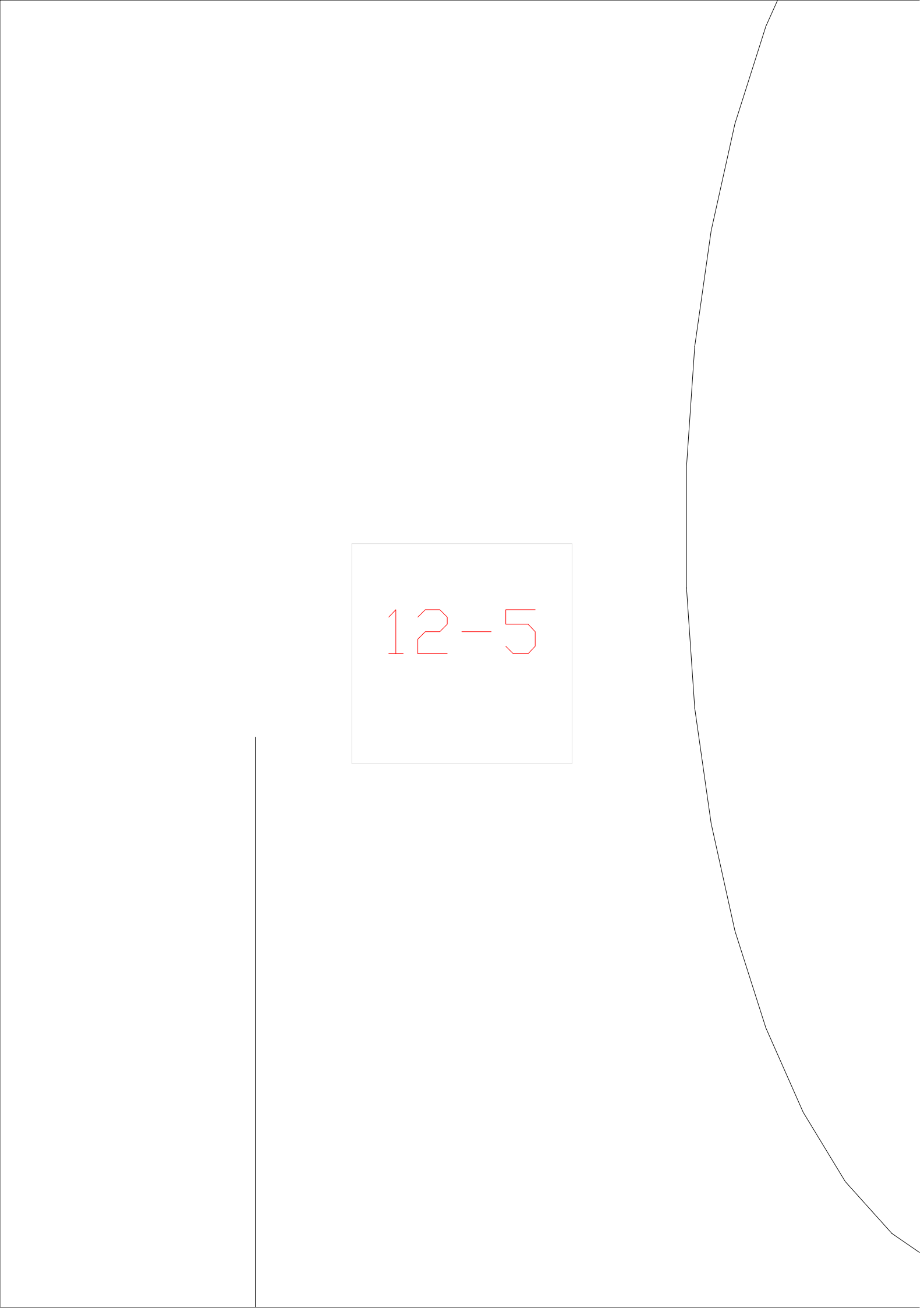
$$12 - 4$$

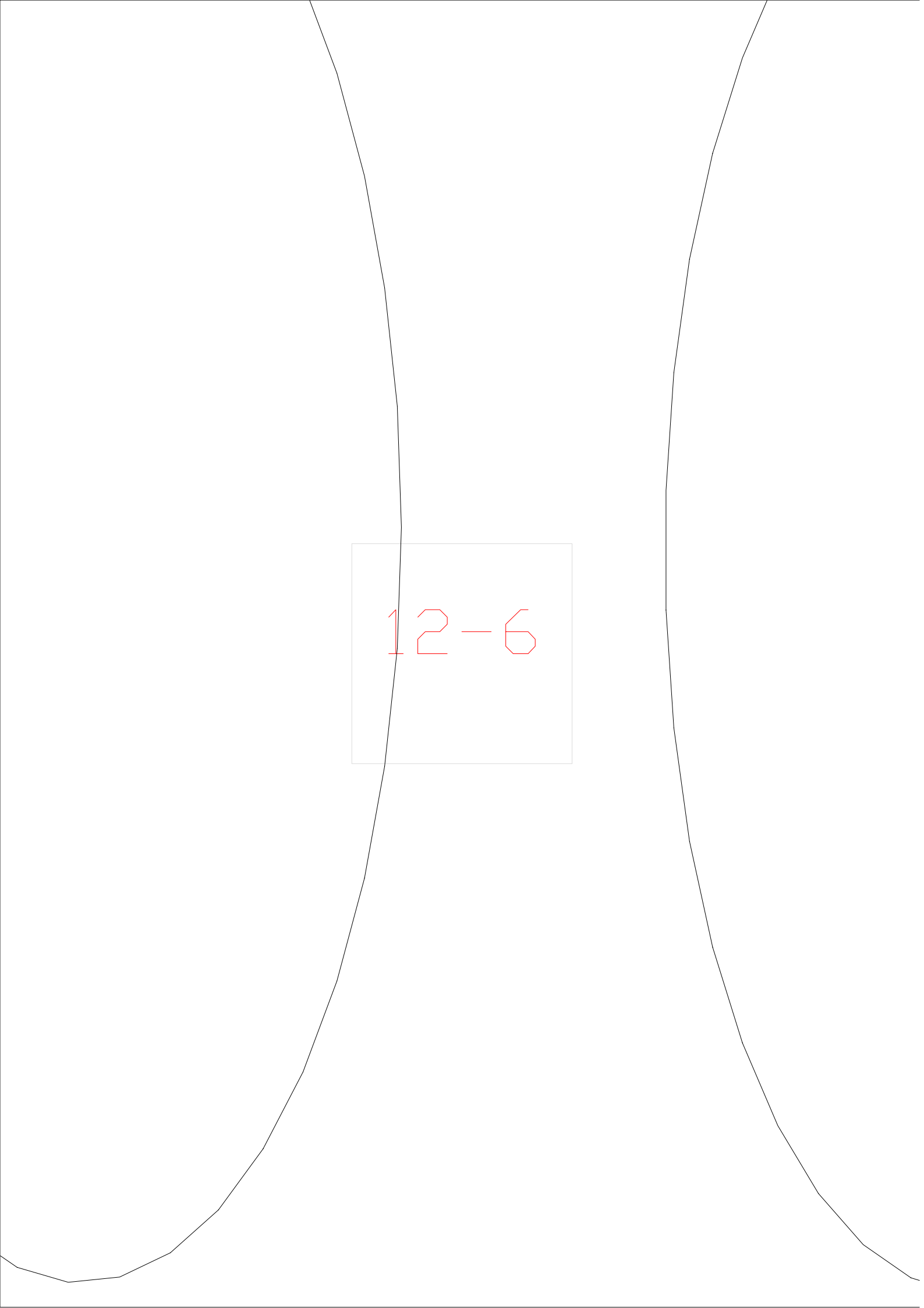

12-5

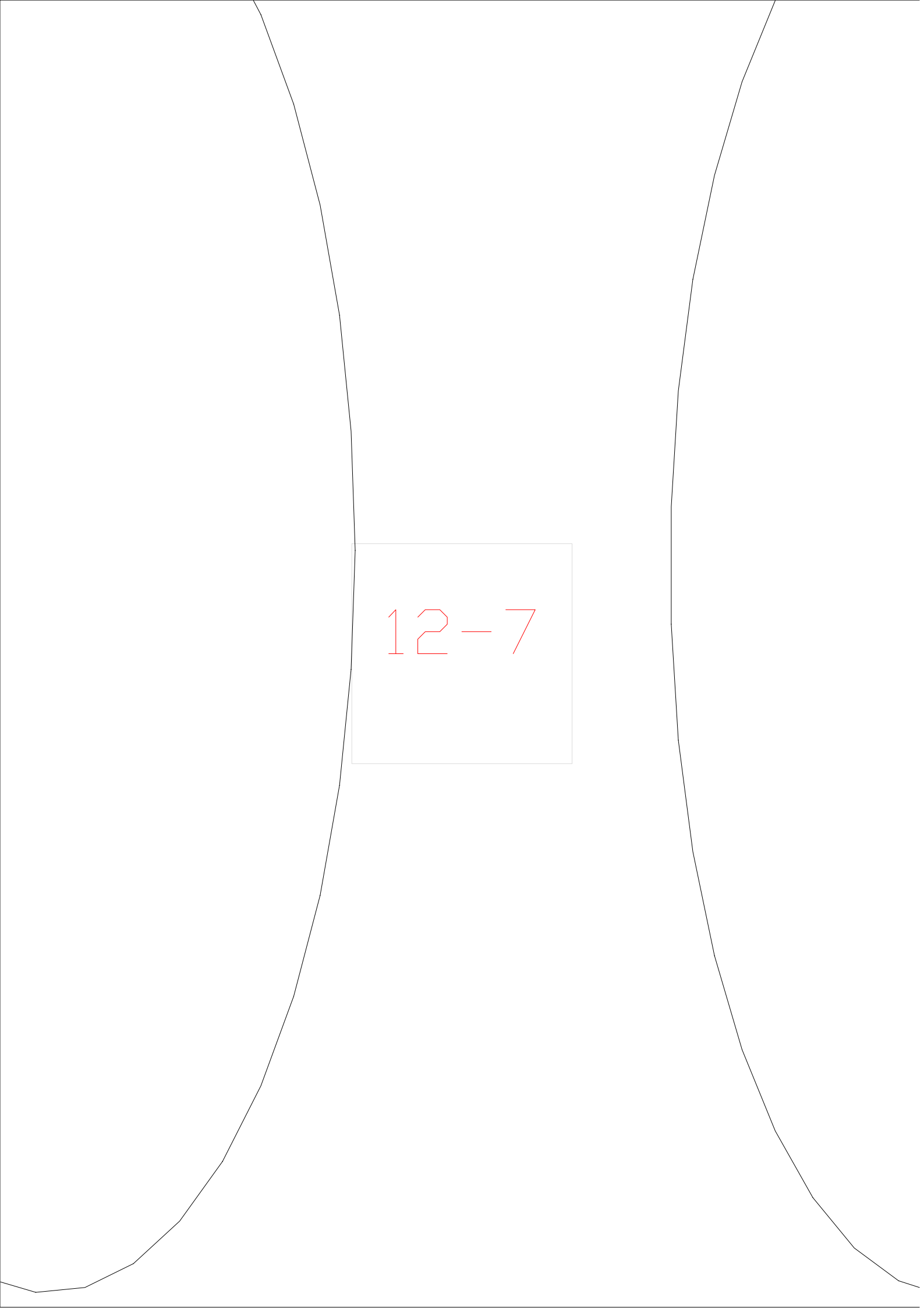

12-6

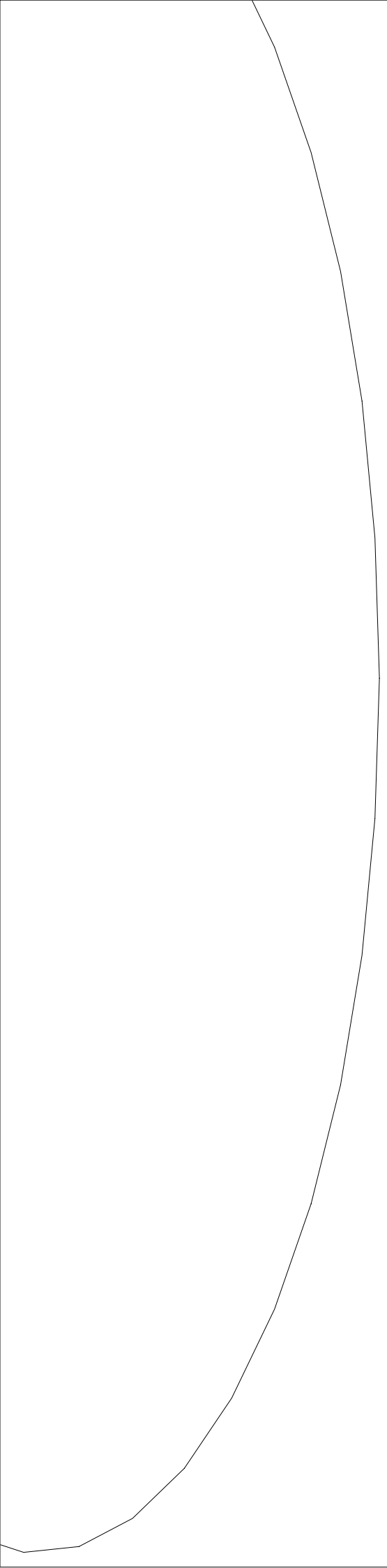

12-7

$$12 - 8$$

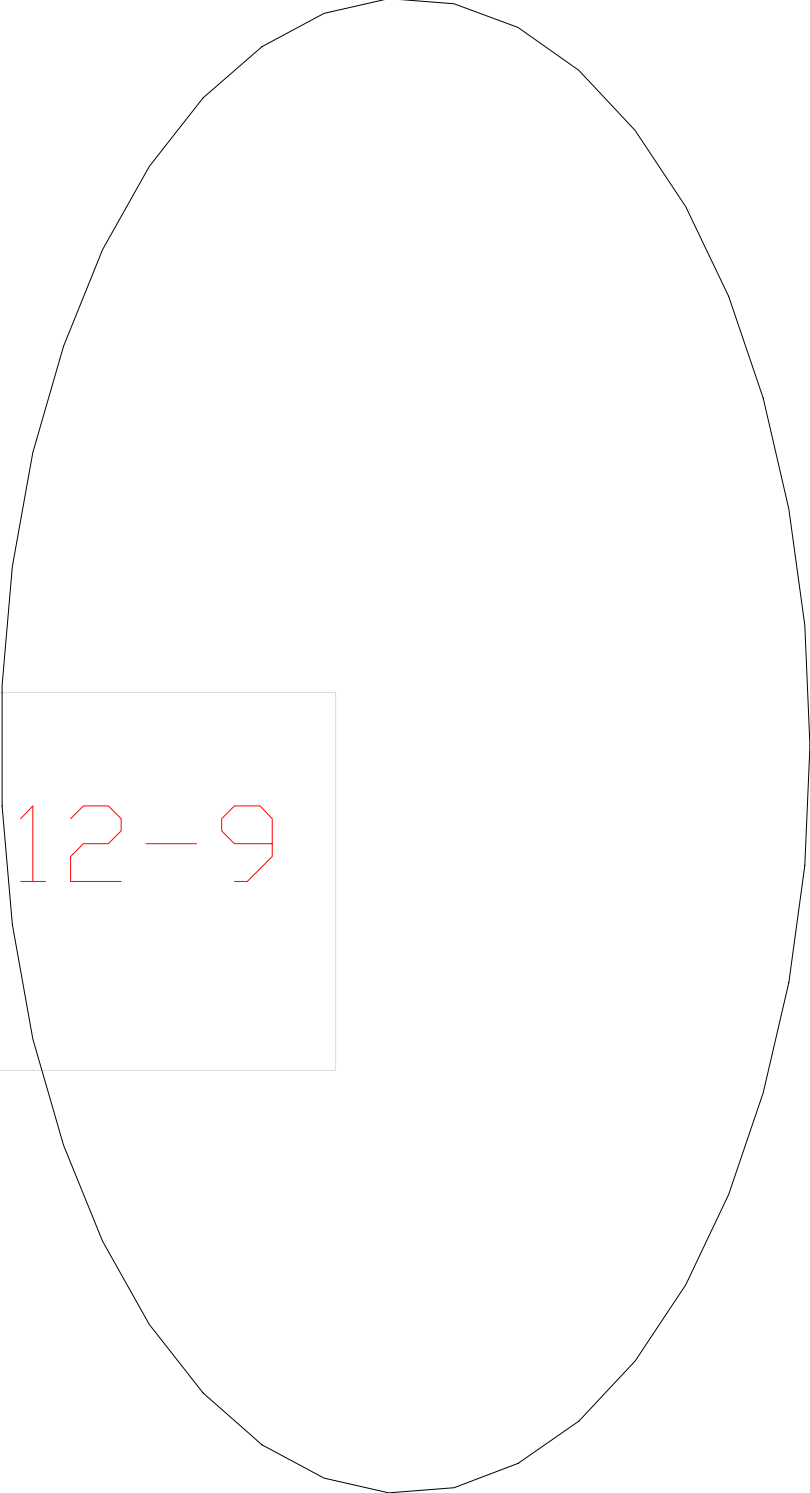

12-9

1-2

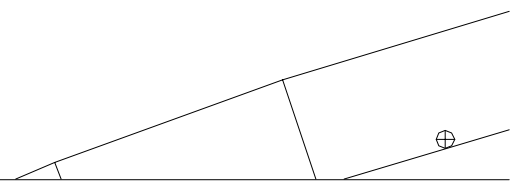

⊕

13-10

13-11

13-12

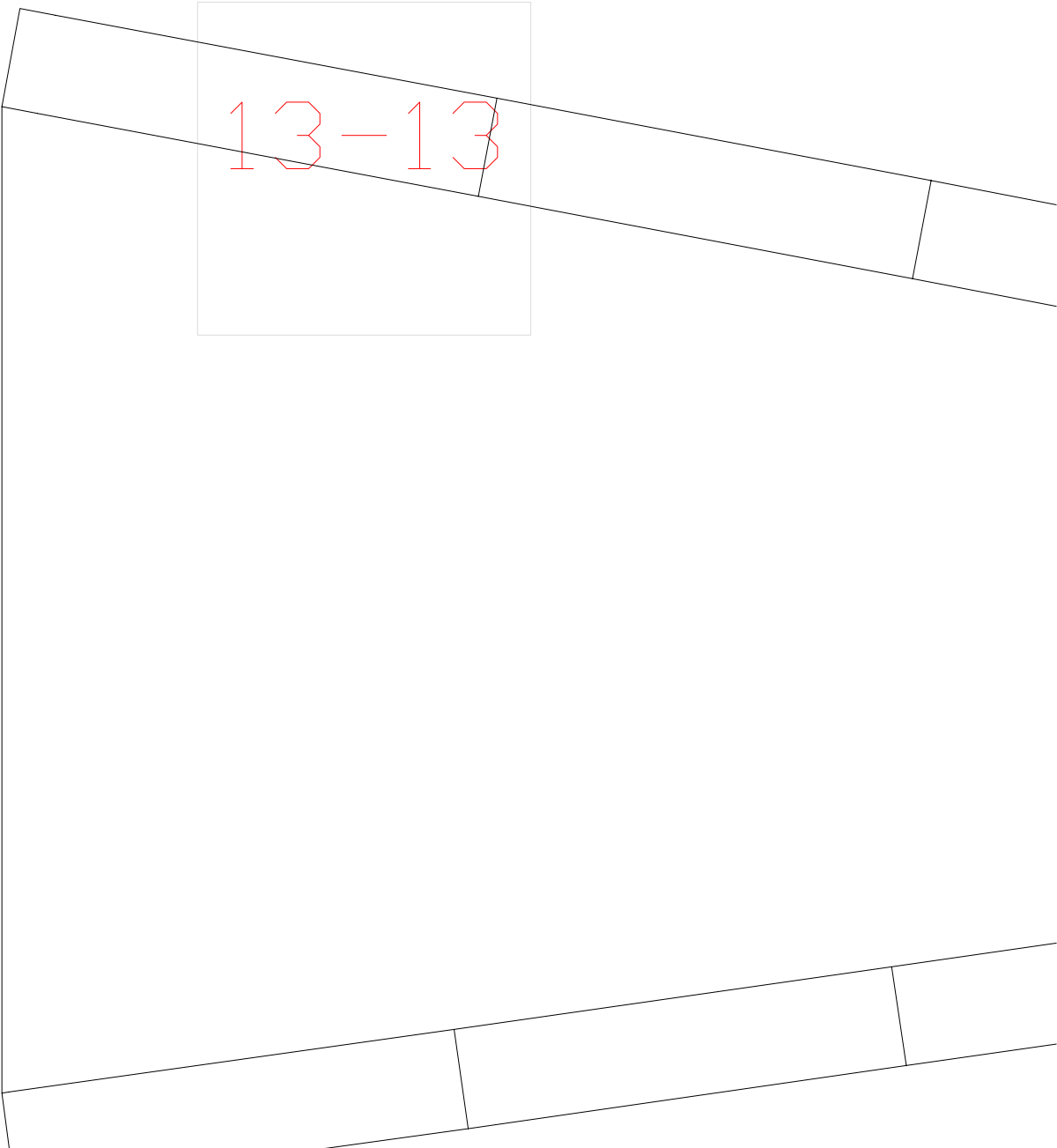

13-13

The image shows a technical drawing of a tapered shaft. The shaft is oriented horizontally and tapers from left to right. A vertical section line is drawn through the shaft, labeled '13-13' in red. This section line is highlighted by a light gray rectangular box. The shaft is divided into three segments by two vertical lines. The top and bottom edges of the shaft are slightly curved, suggesting a rounded or chamfered end. The drawing is a simple line drawing with no shading or texture.

13-14

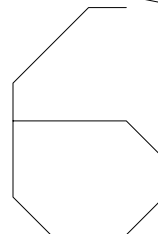

13-15

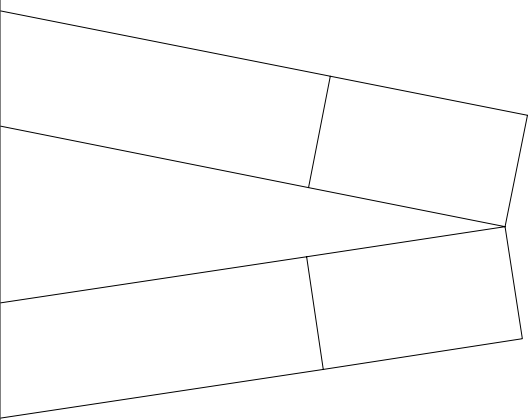

13-16

13-1

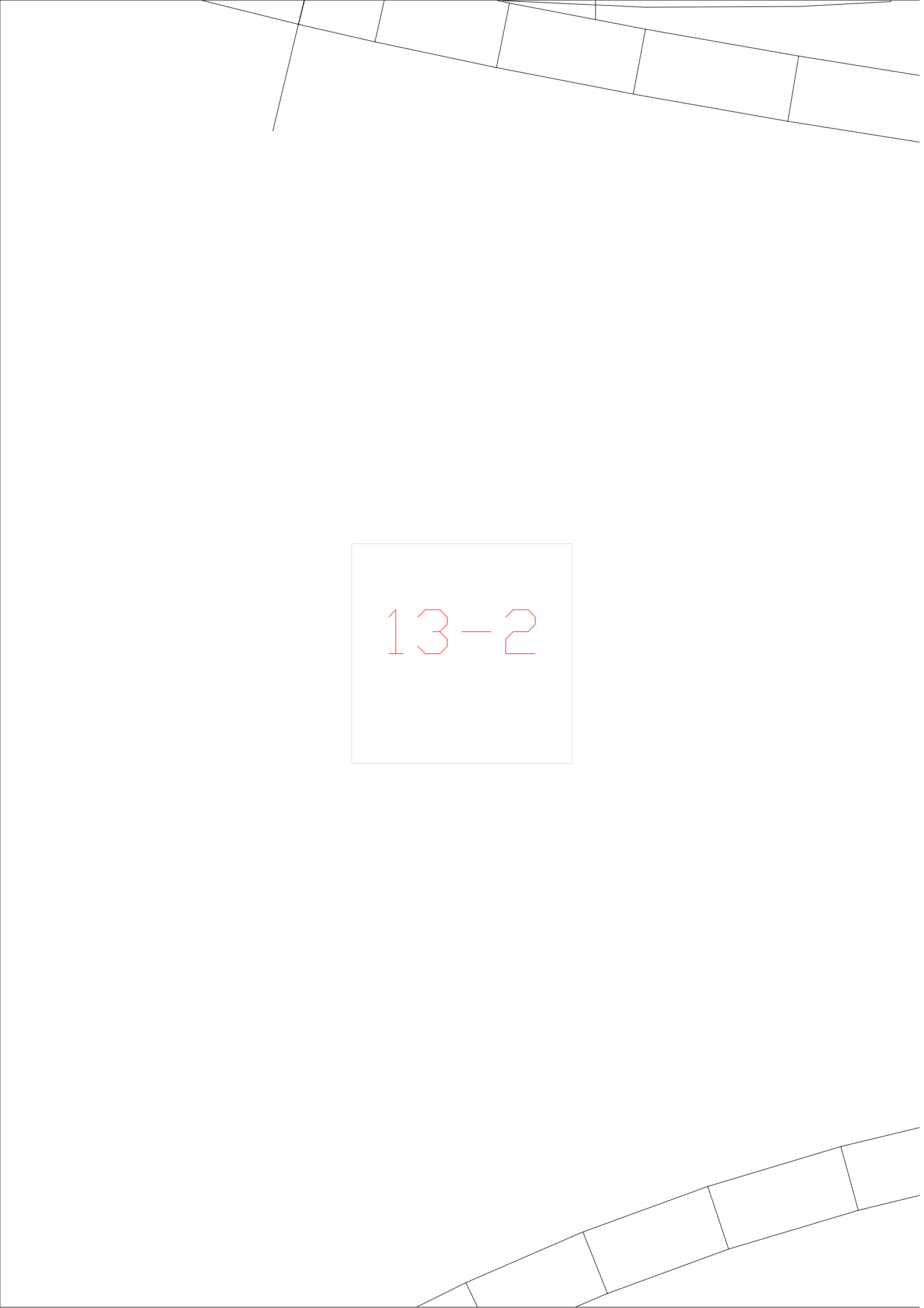

13-2

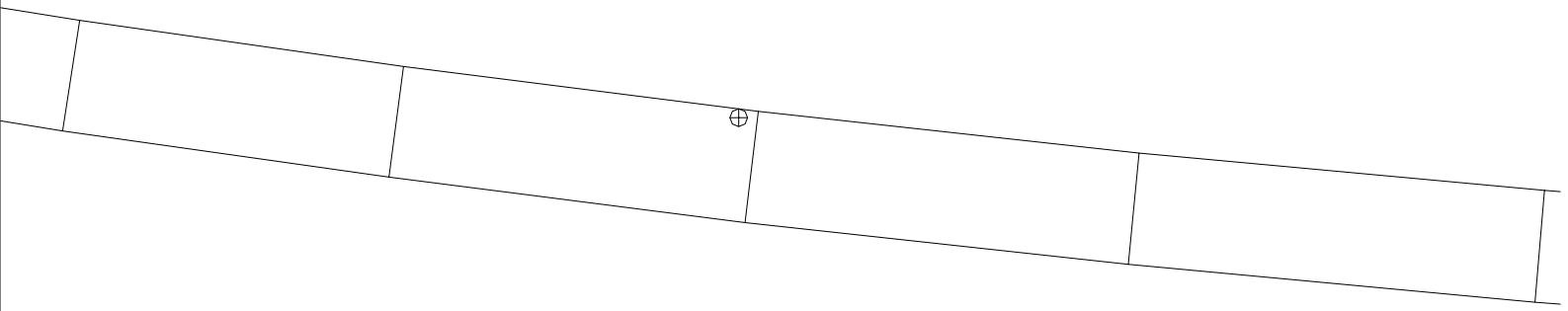

13-3

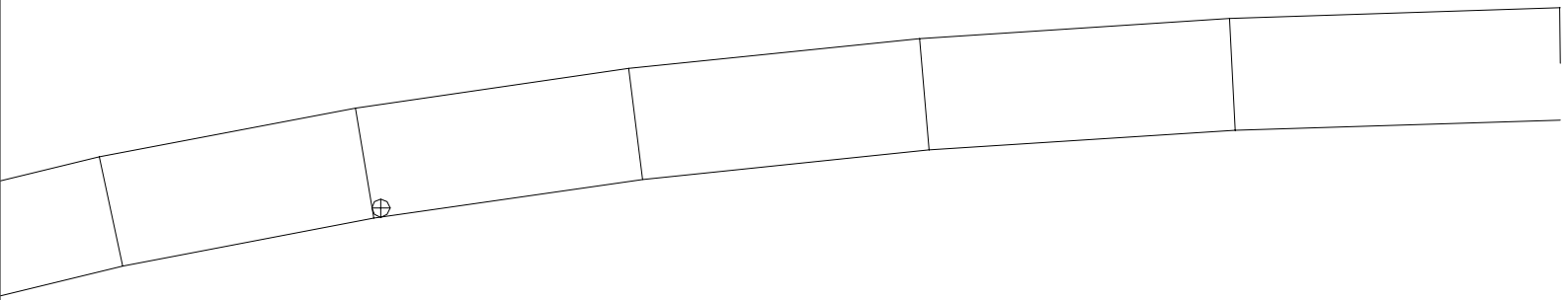

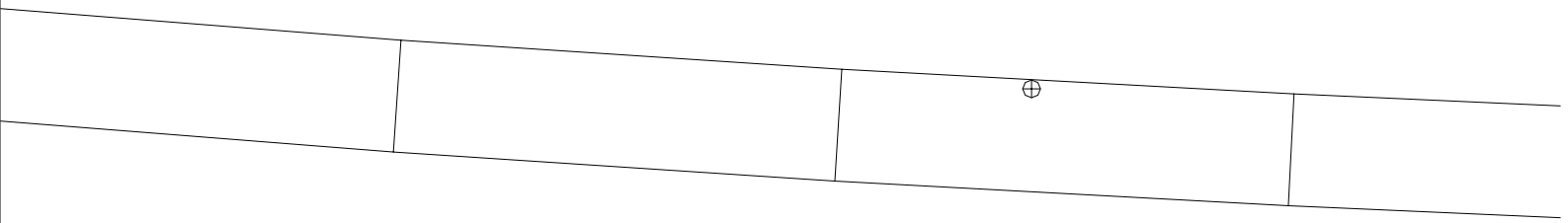

13-4

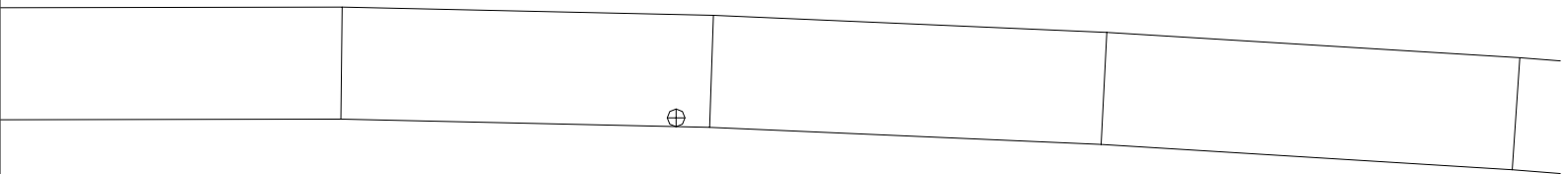

13-5

13-6

⊕			
---	--	--	--

13-7



13-8

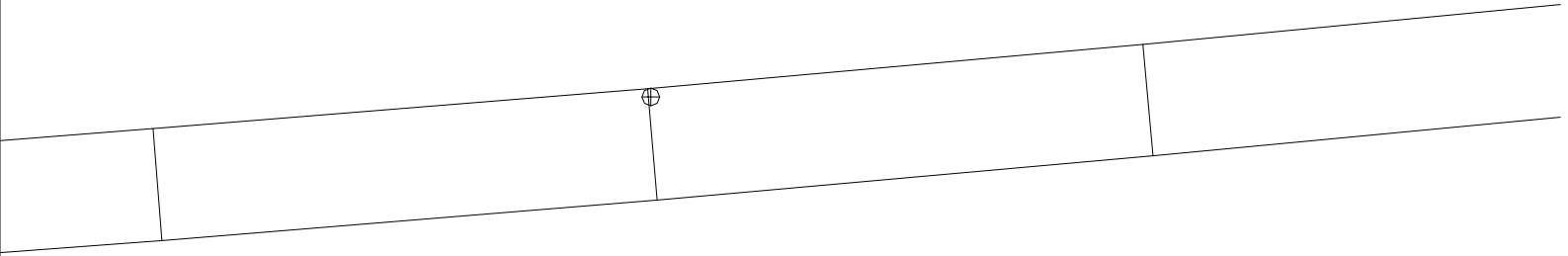

13-9

1-3

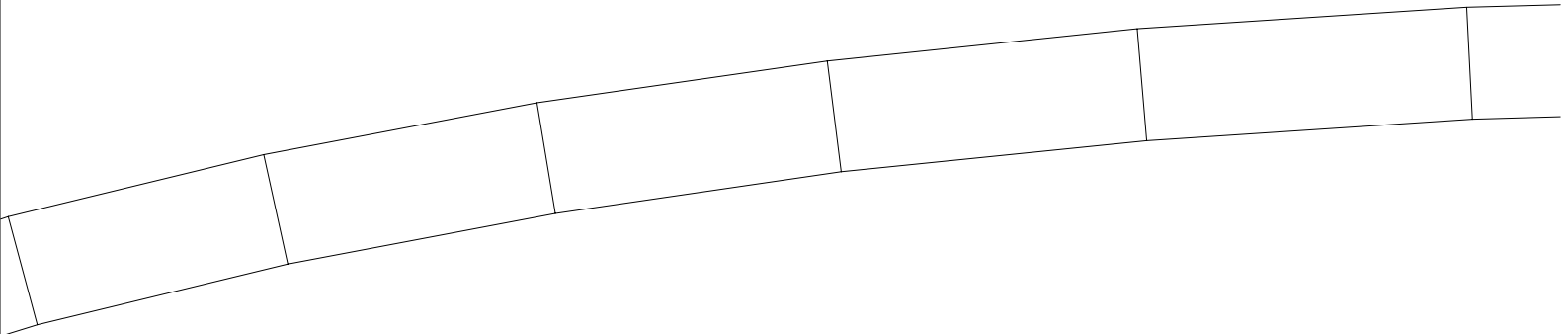

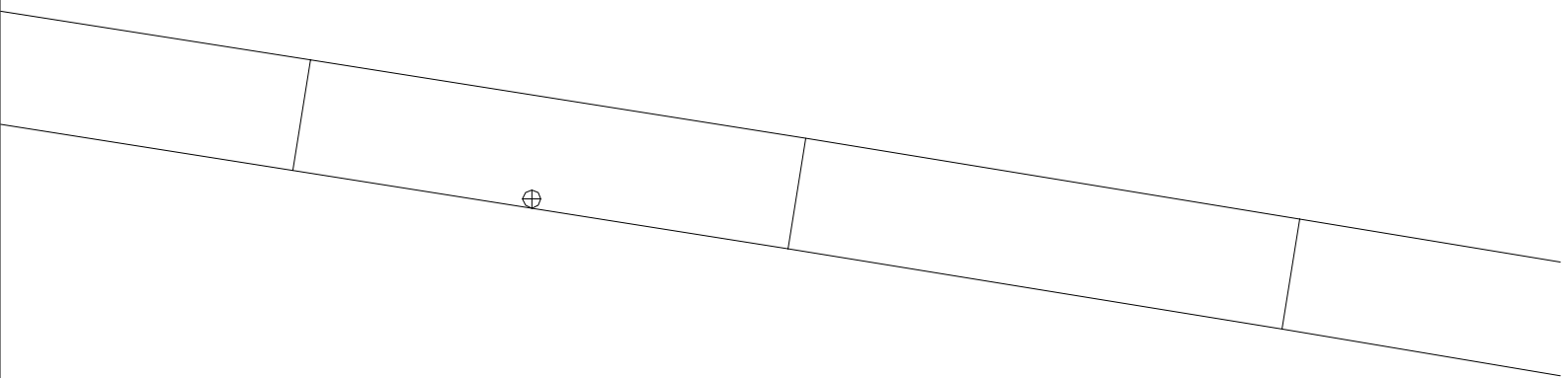

14-10

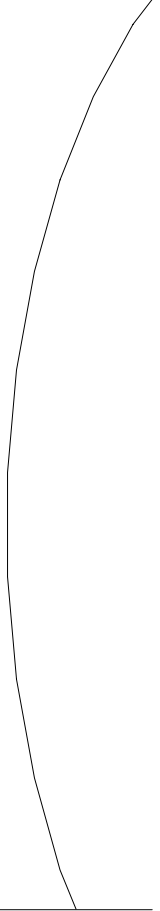
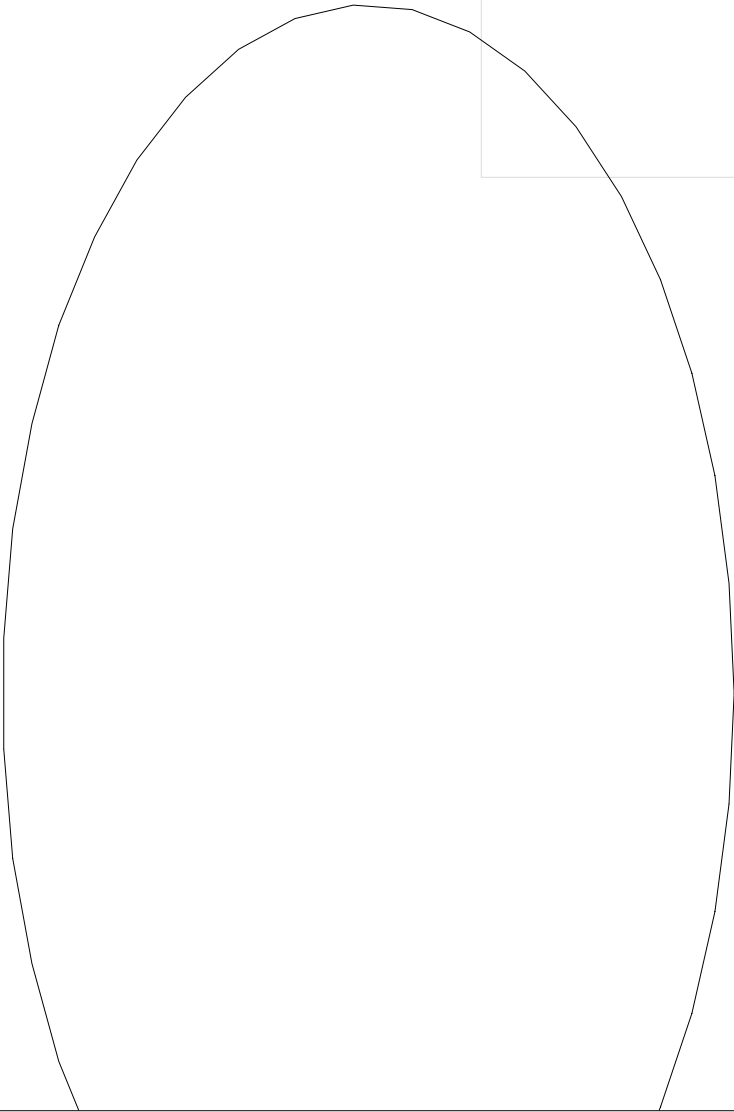

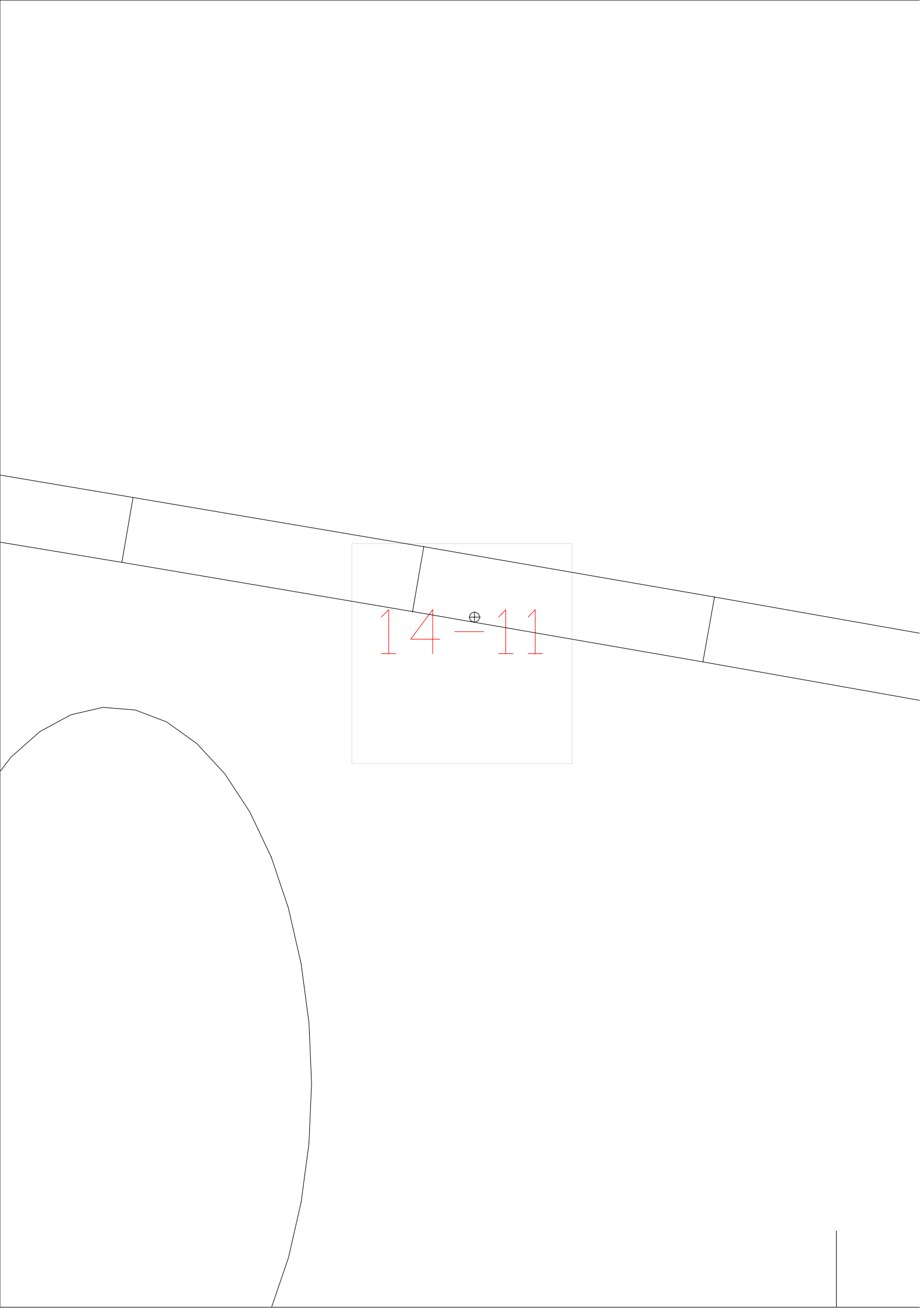

14-11



14-12

⊕

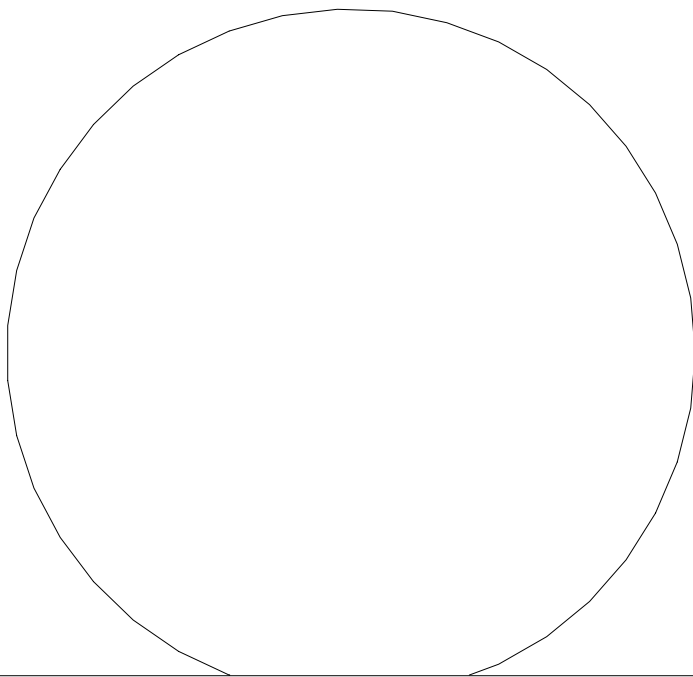

14-13

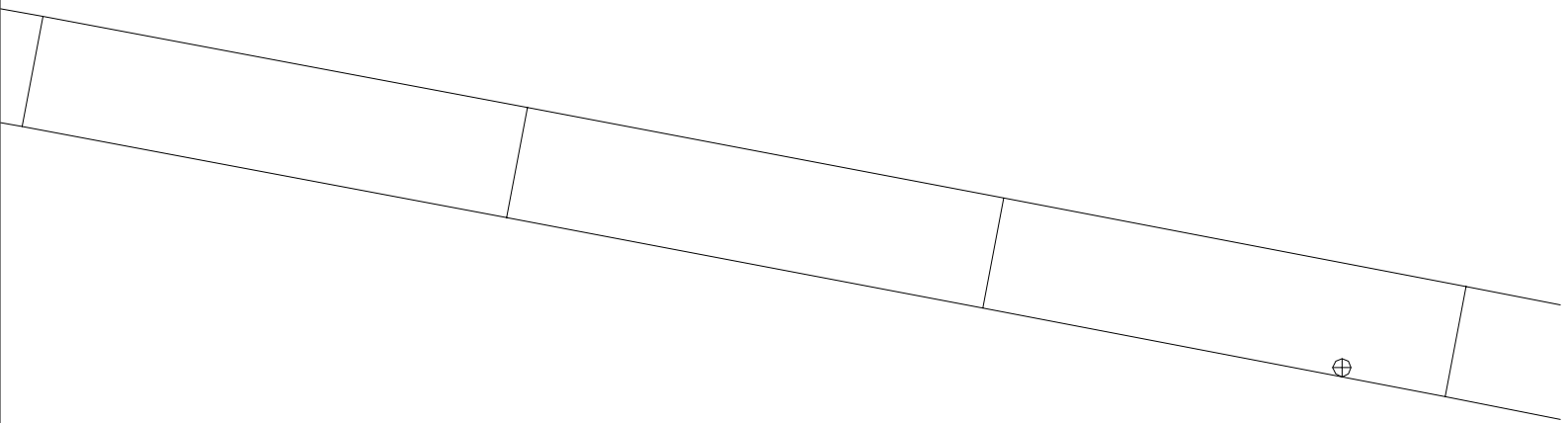

14-14

14-15



14-16

14-1

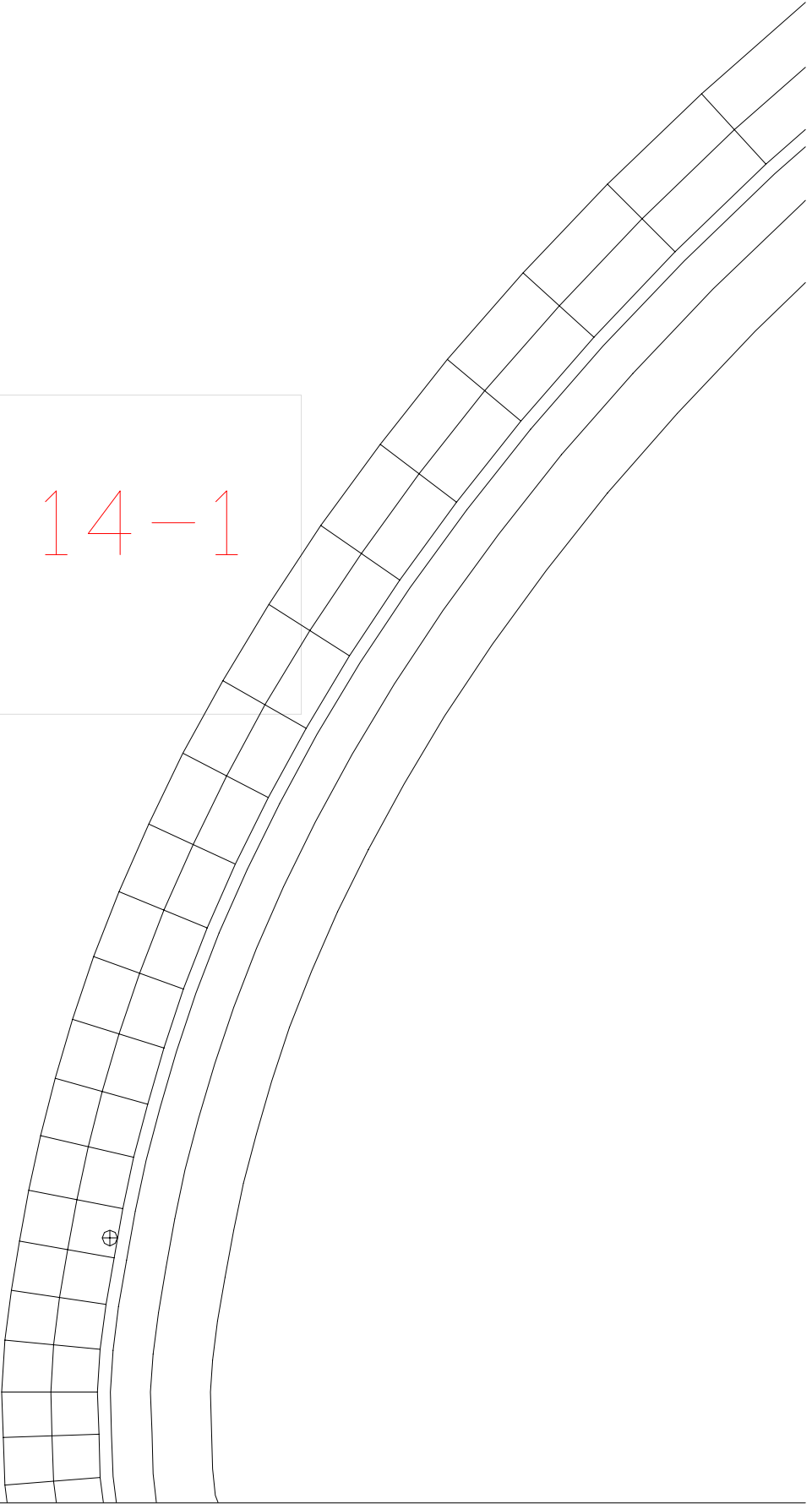

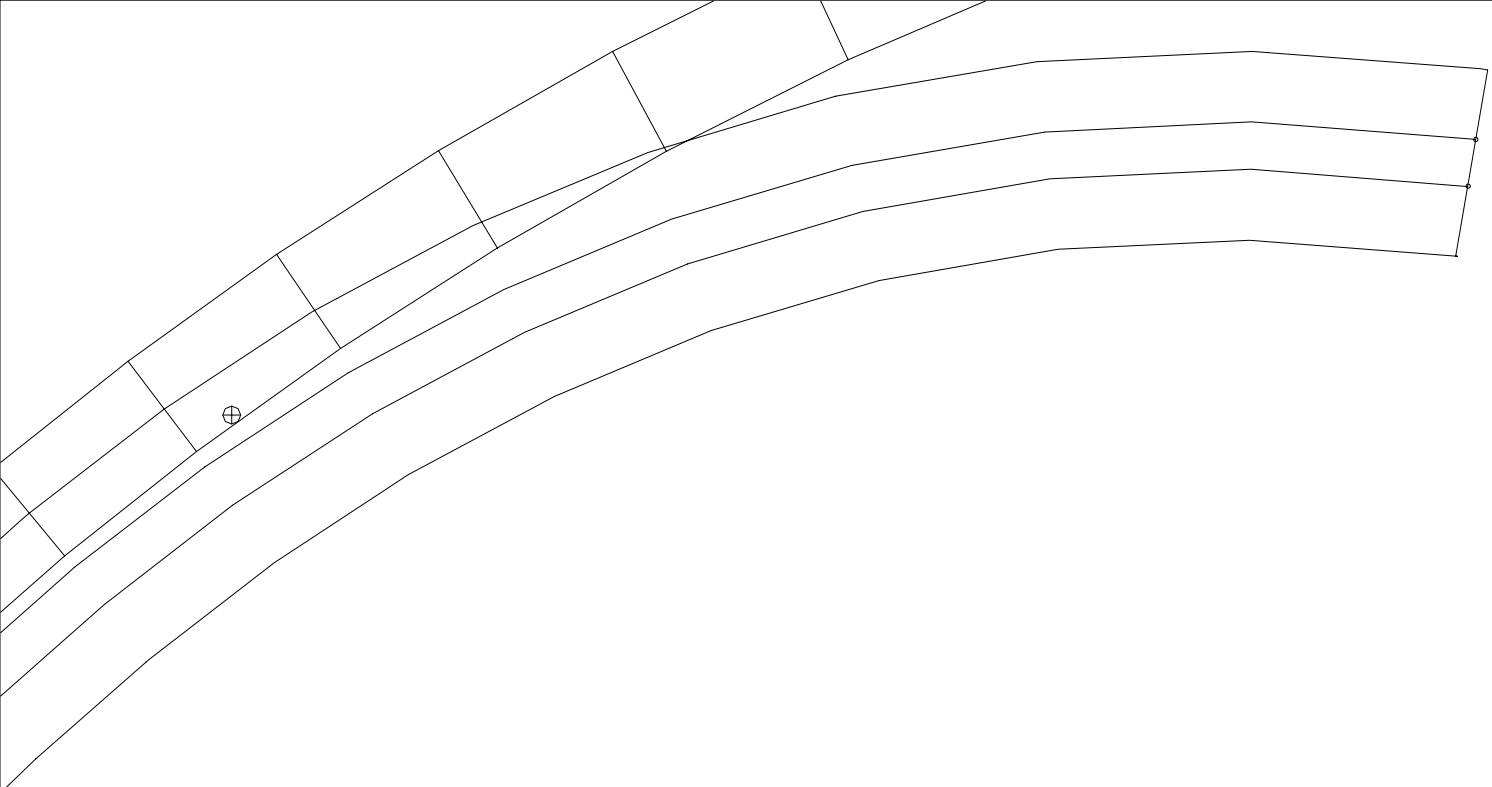

14-2

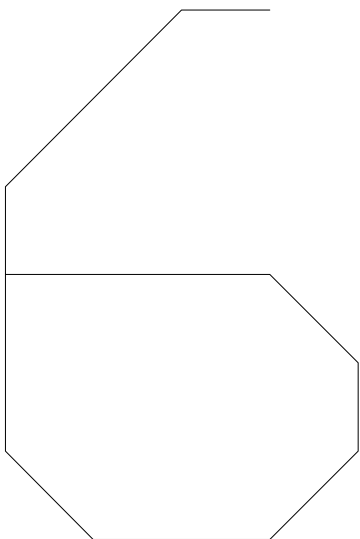

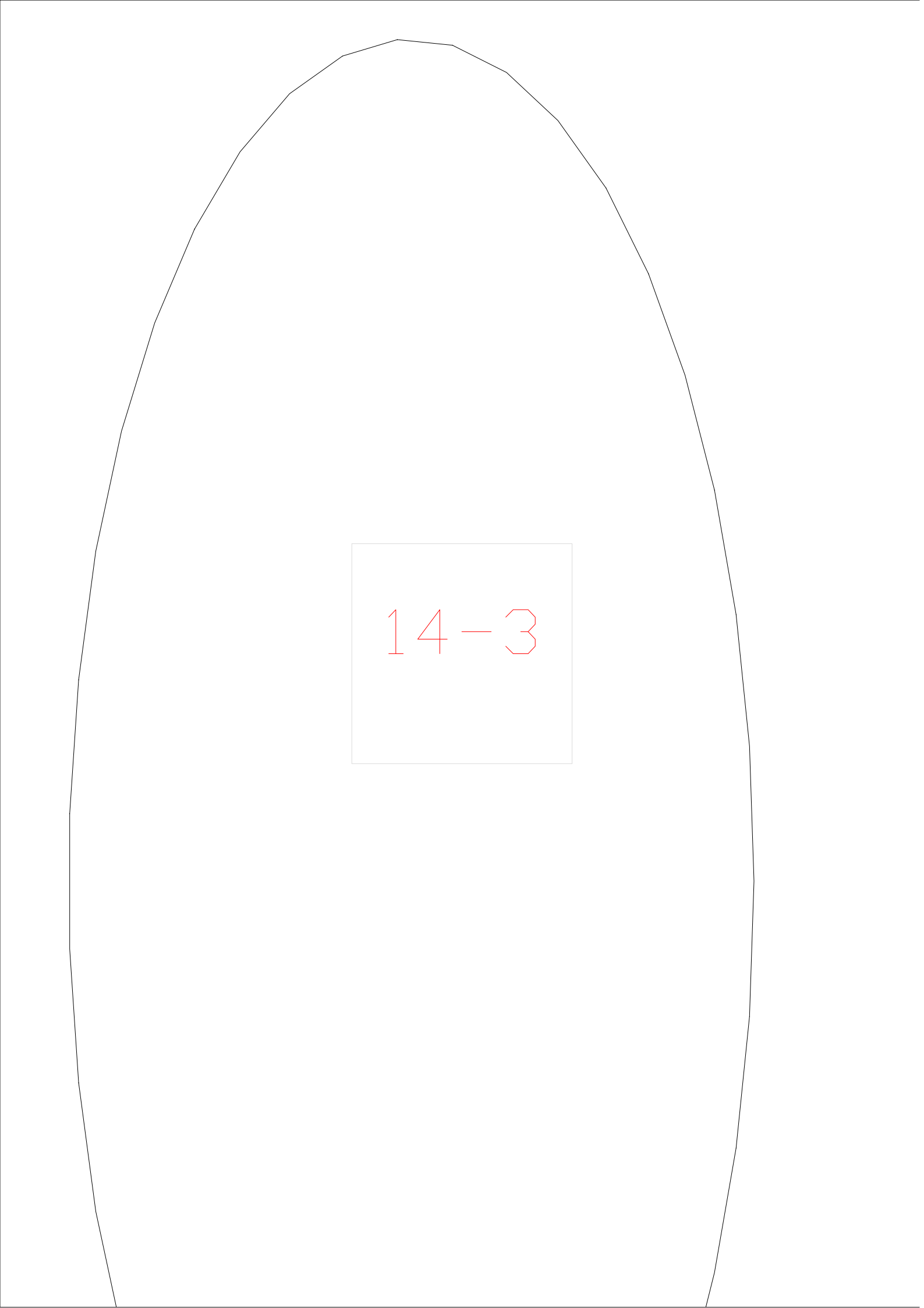

14-3

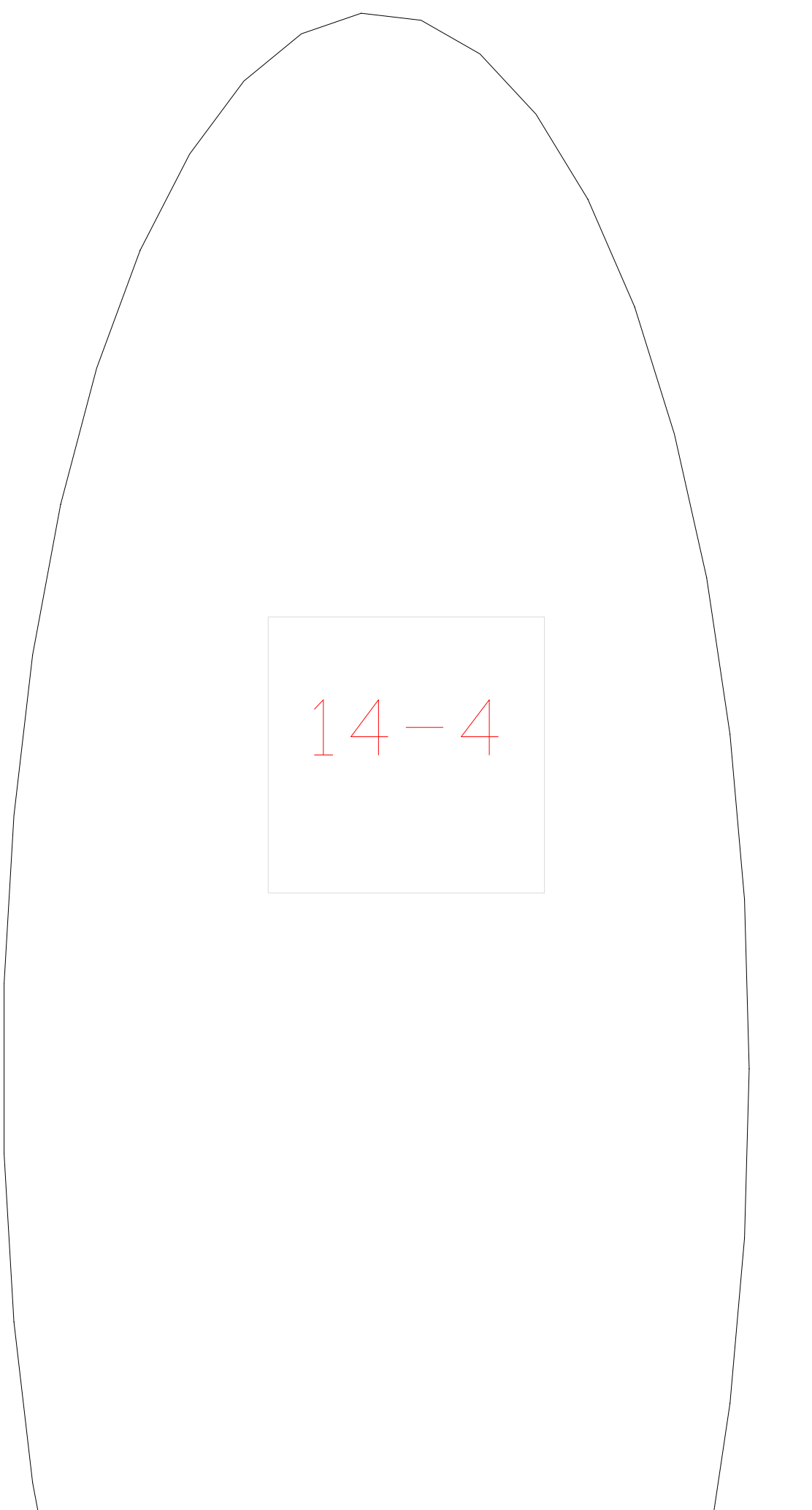
 $14-4$

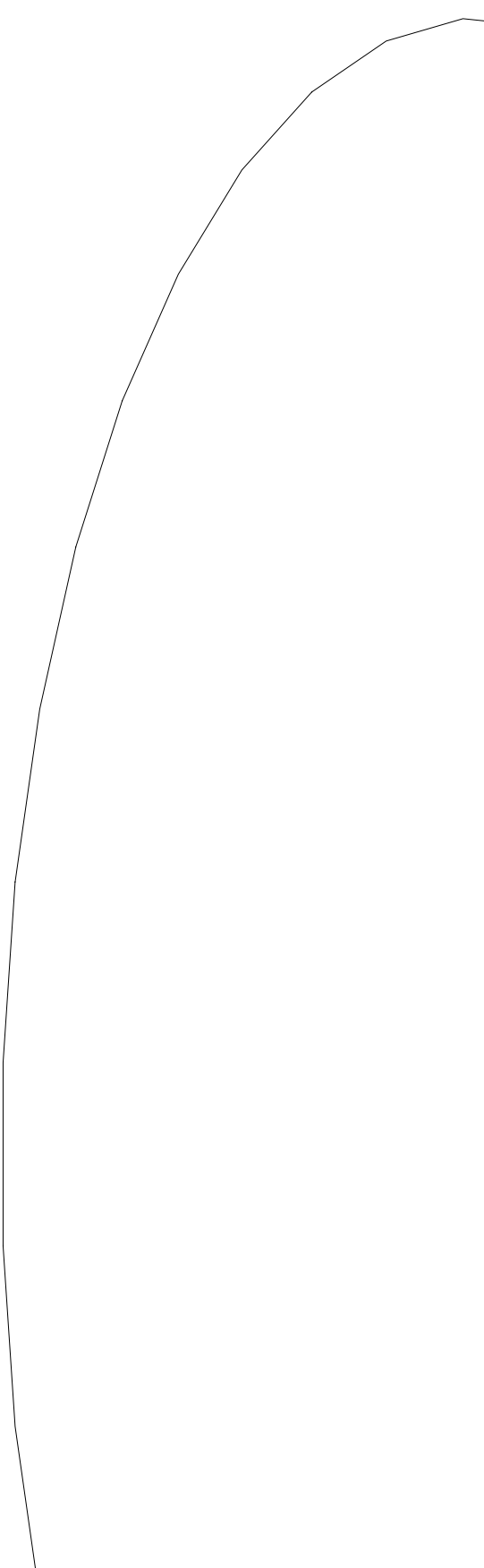

14-5

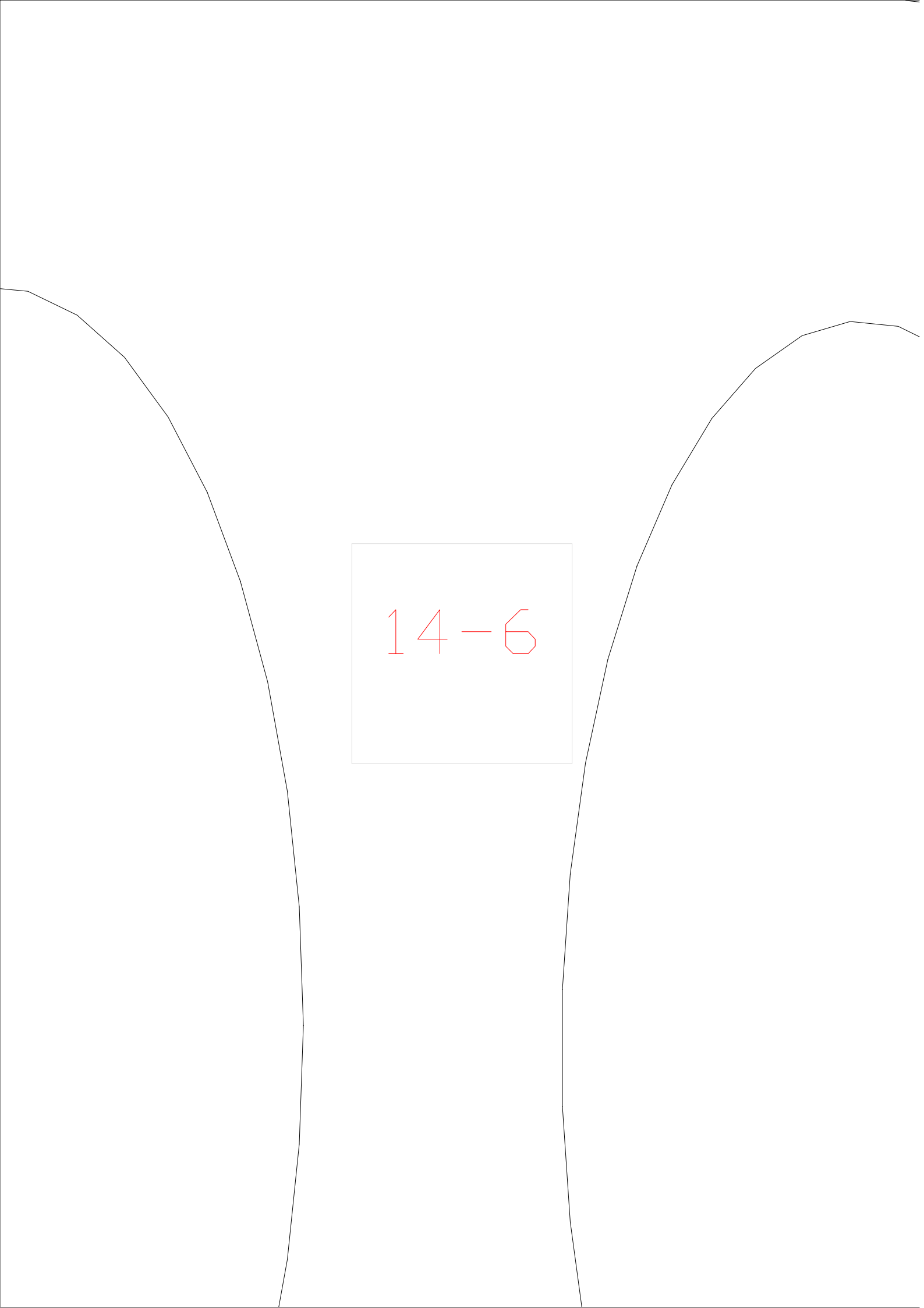

14-6

14-7



$14 - 8$

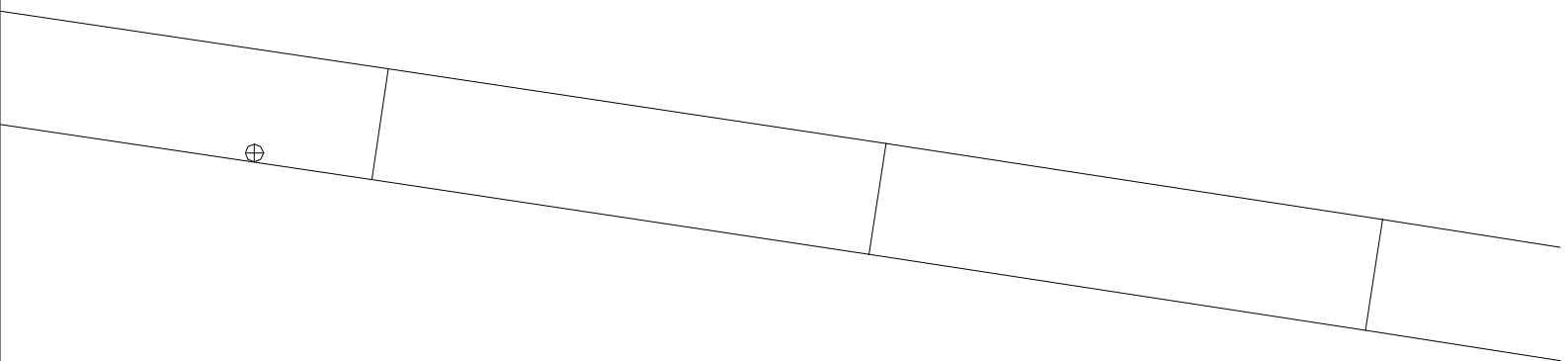

14-9

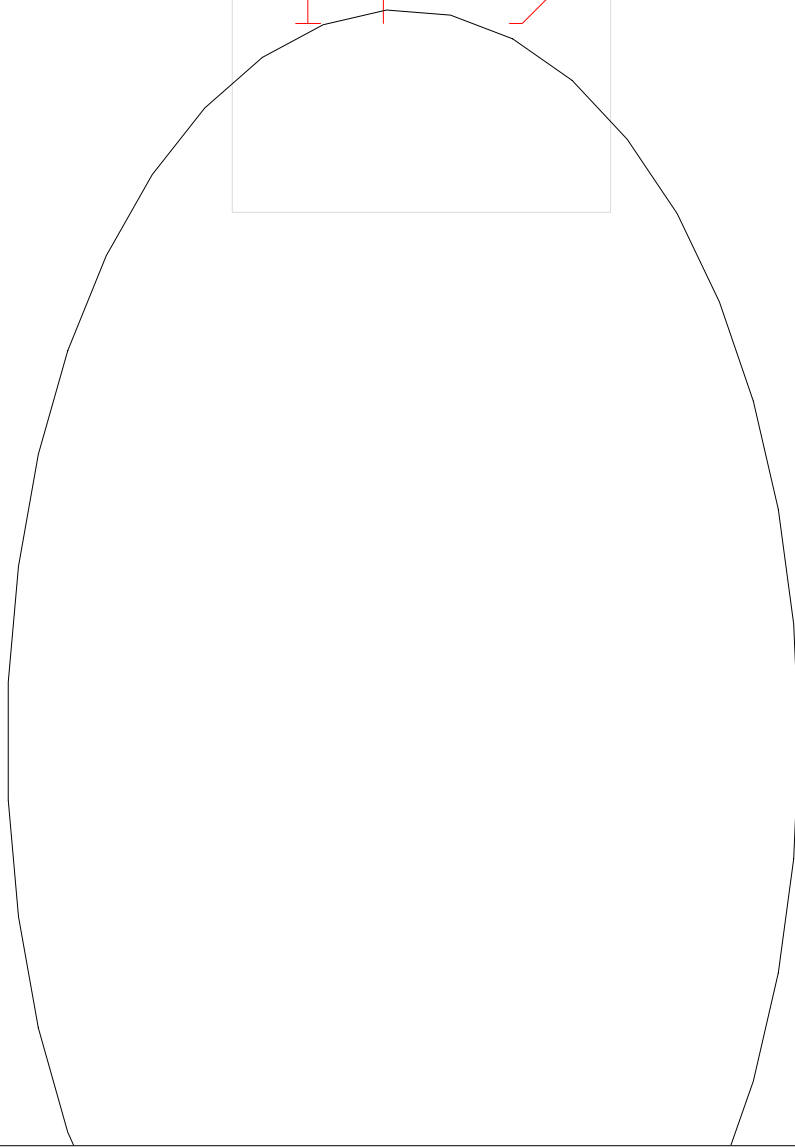

1-4

⊕

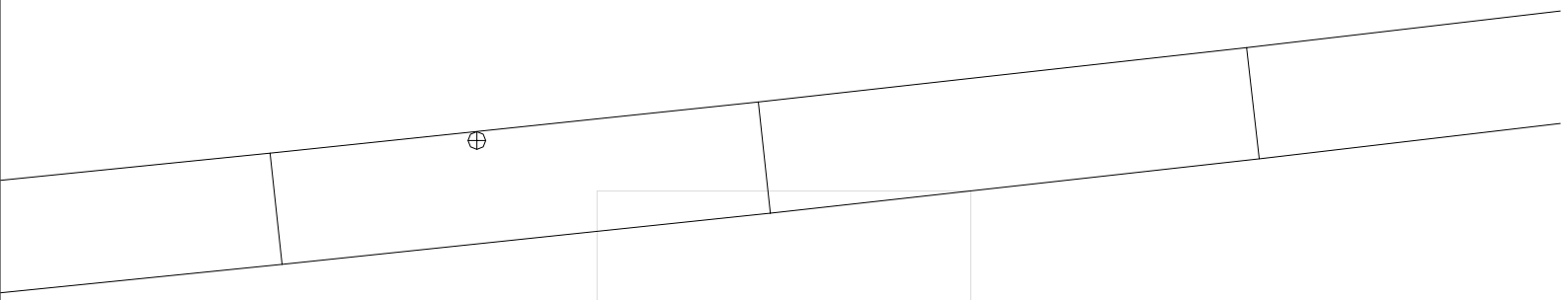
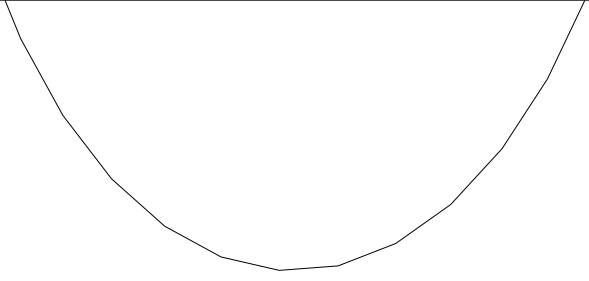

15-10



15-11

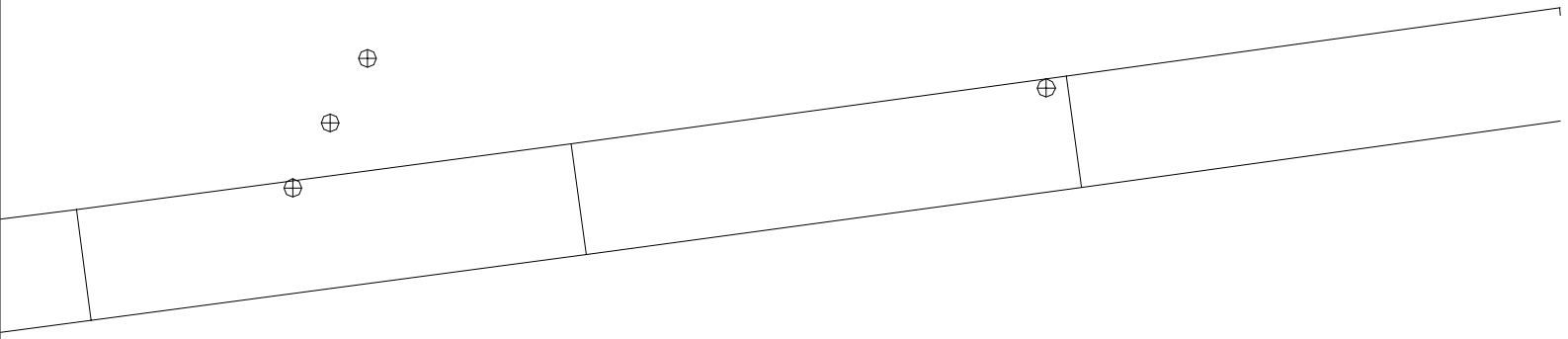

15-12

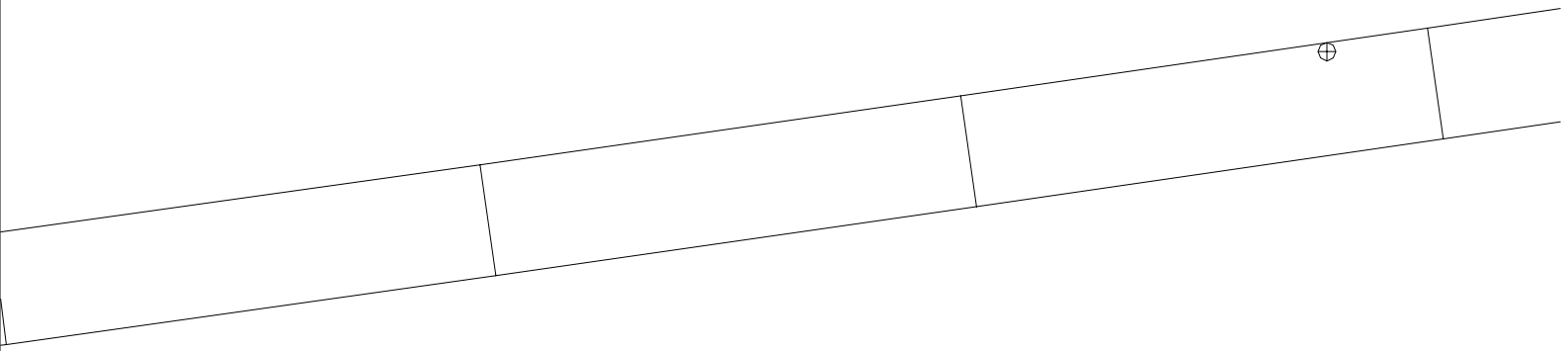

15-13

15-14

15-15

15-16

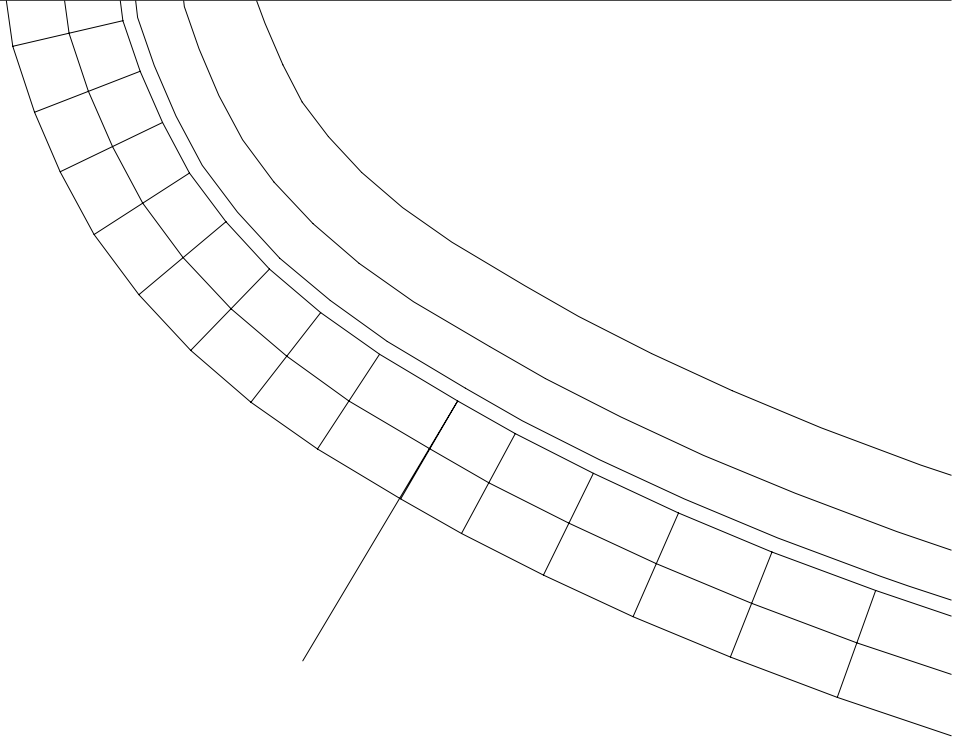

15-1

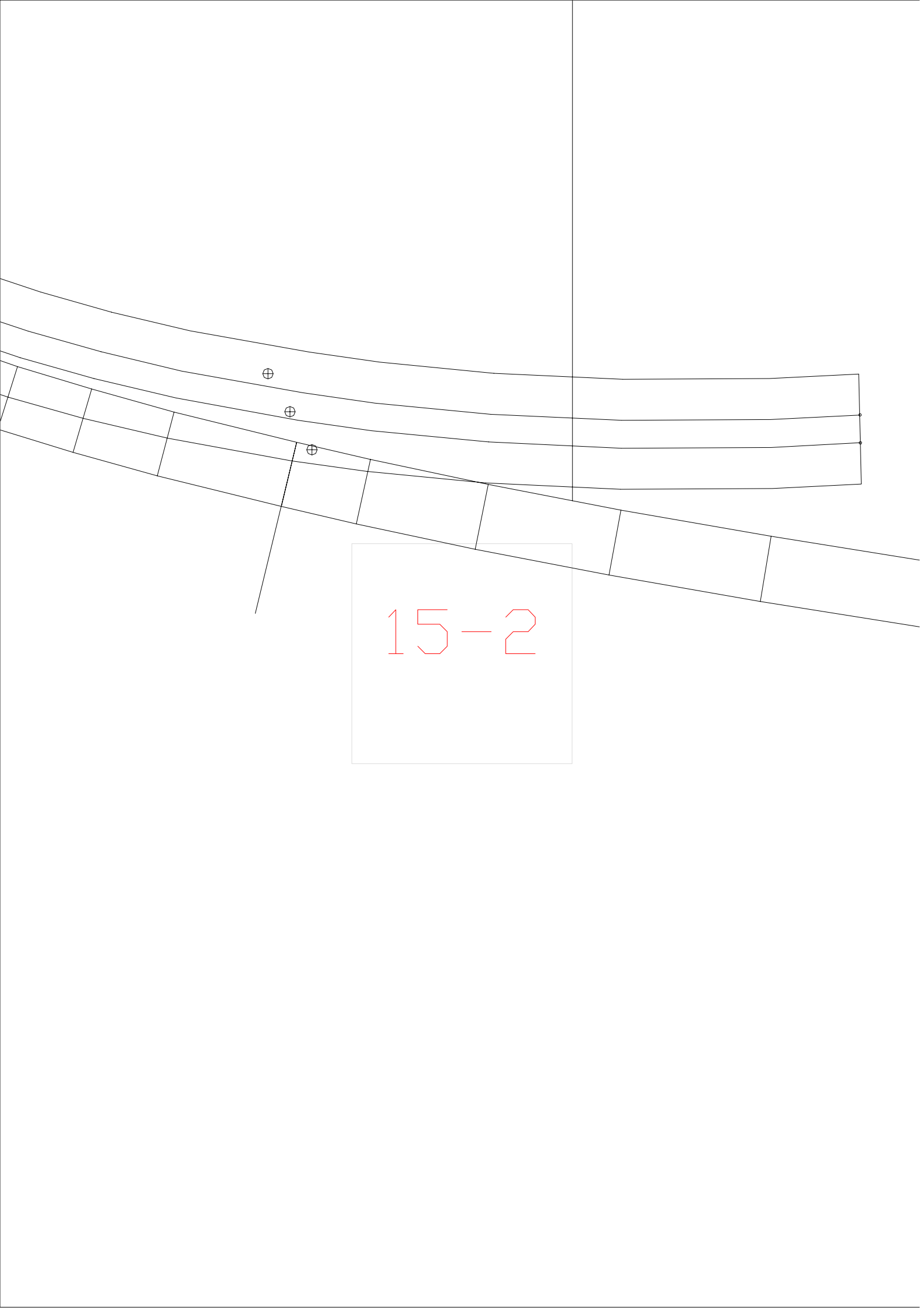

15-2

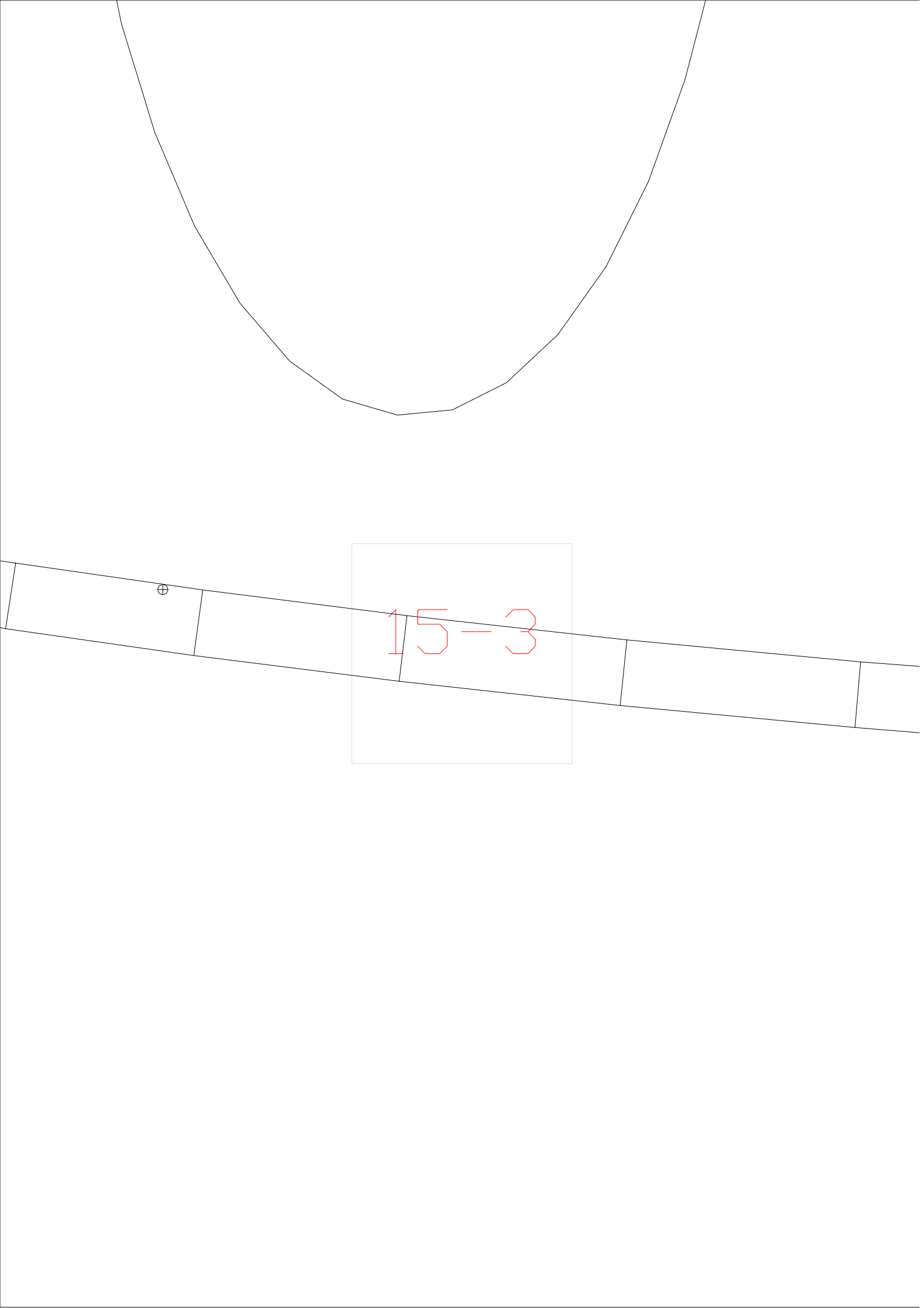

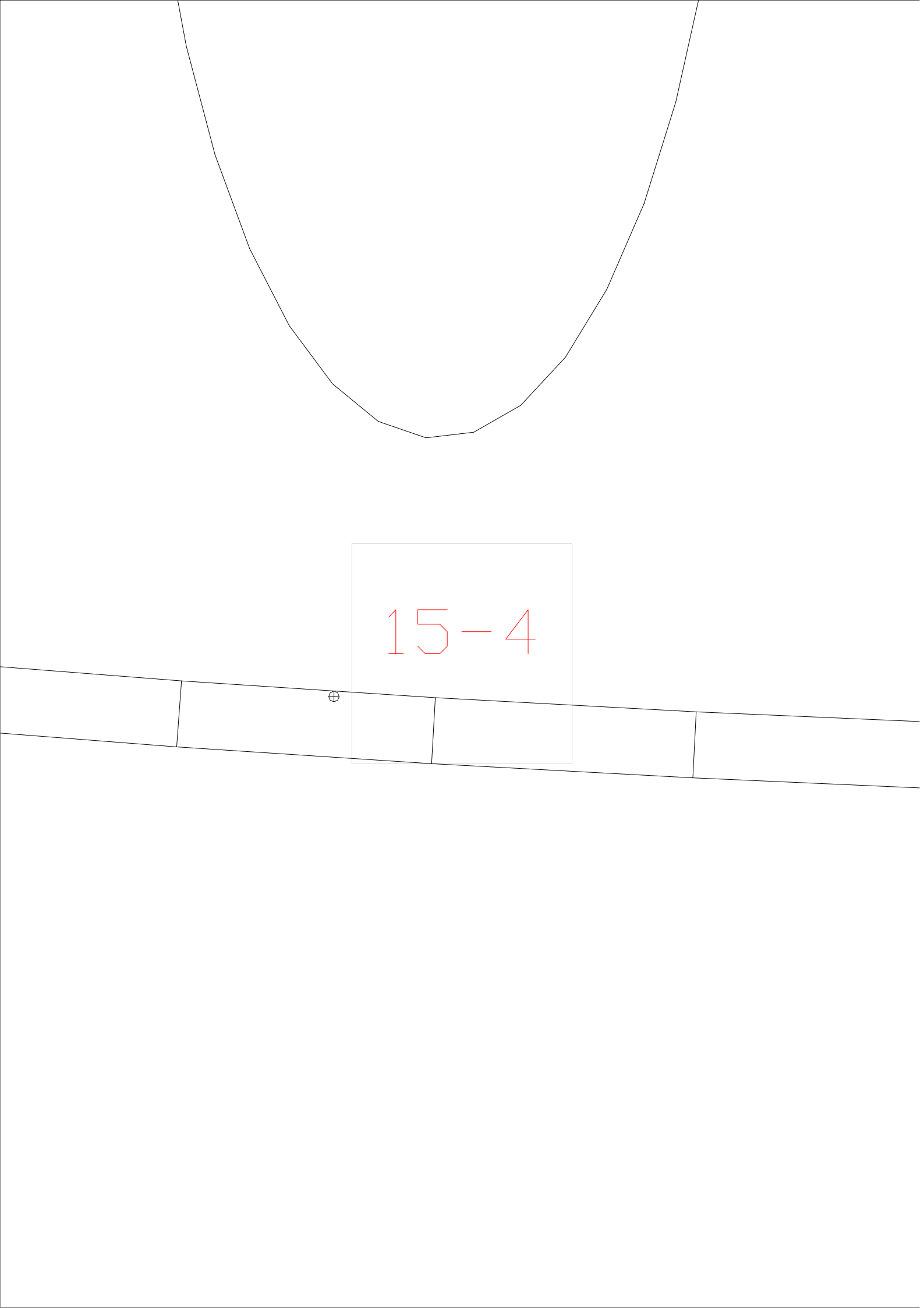

15-4

15-5

⊕

15-6

The image shows a technical drawing of a structure. At the top, there are two curved lines that meet at a central point, forming a shape similar to a wide 'V' or a shallow arch. Below this, a horizontal line is drawn. A small circle with a cross inside (⊕) is located on this horizontal line, slightly to the right of the center. Below the horizontal line, there are two vertical lines that extend downwards, creating a rectangular frame. The text '15-6' is written in red inside this rectangular frame.

15-7

The image shows a technical drawing of a structure, possibly a pipe or duct, with a cross-section. The top part of the drawing shows a curved profile. Below this, a horizontal line represents a surface or boundary. A central rectangular area is highlighted with a light blue background and contains the text '15-7' in red. To the right of this area, there is a small circle with a cross inside, likely representing a hole or a specific feature. The drawing is composed of black lines on a white background.

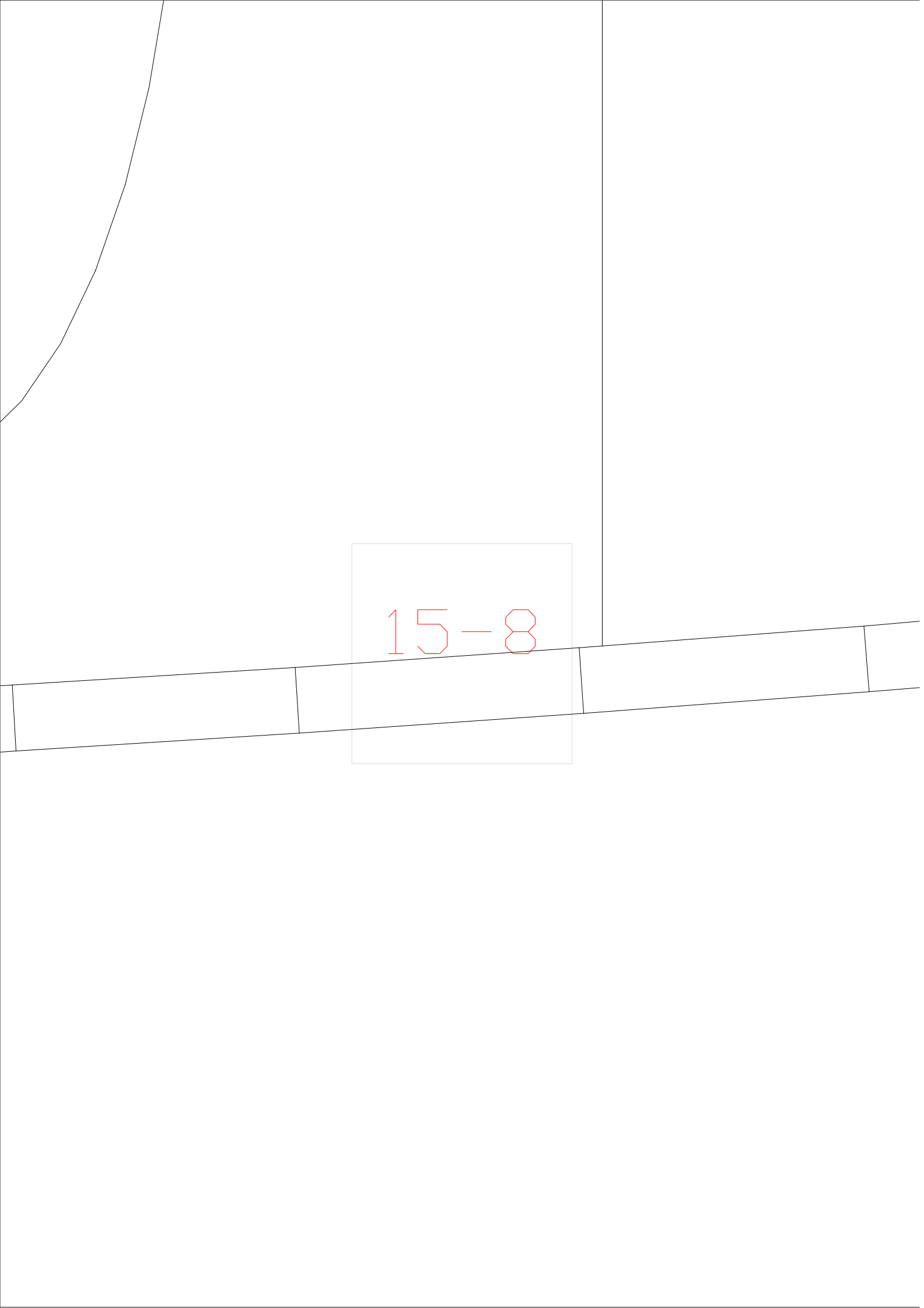

15-8

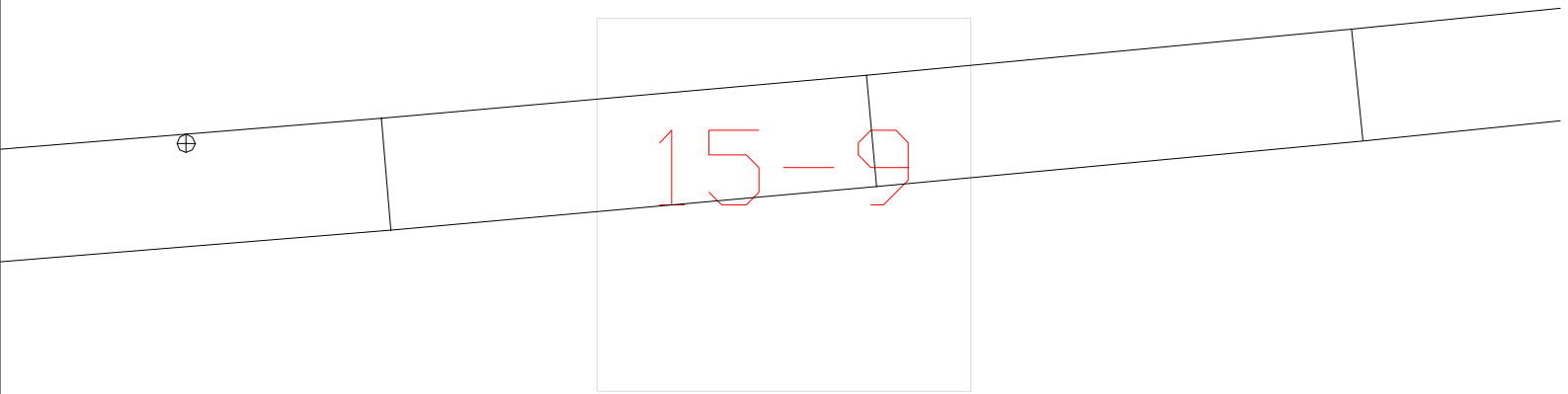
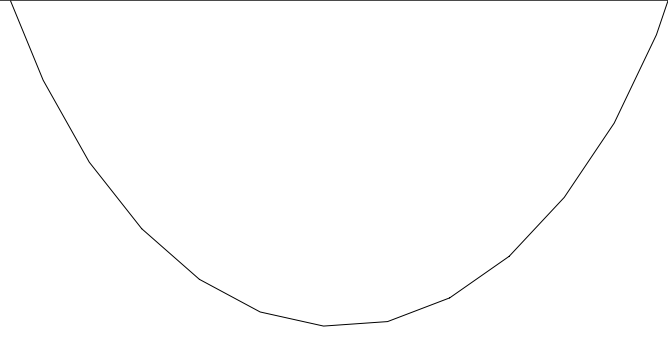

1-5

⊕

1-6

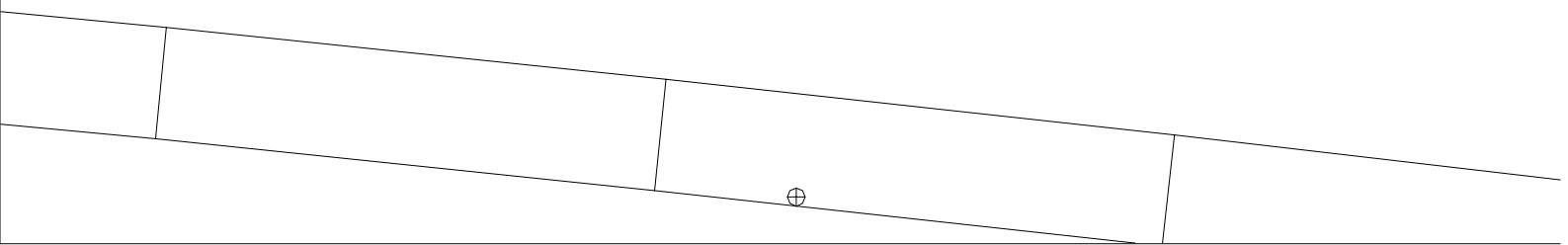

1-7

1-8

1-9

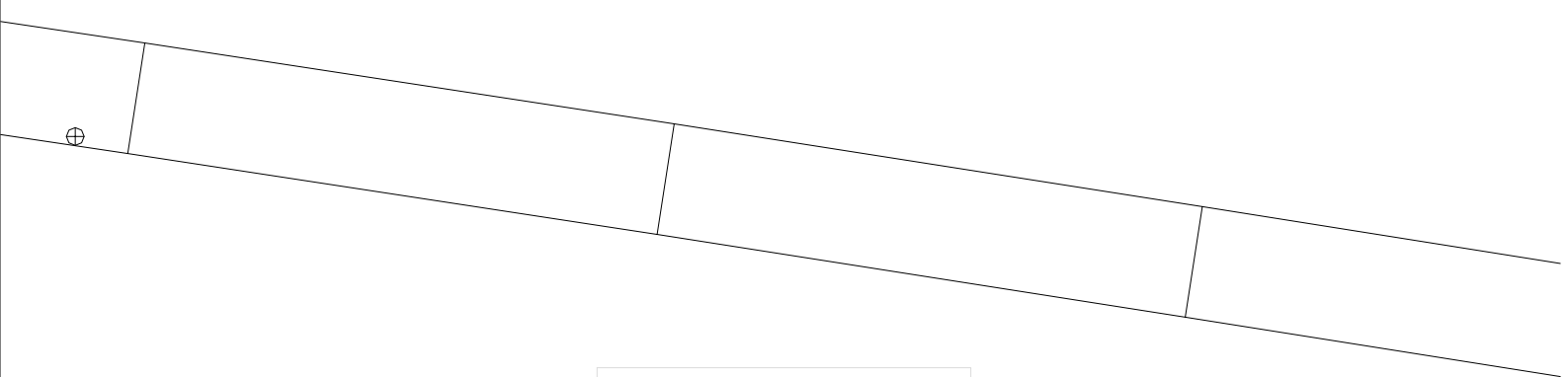

2-10

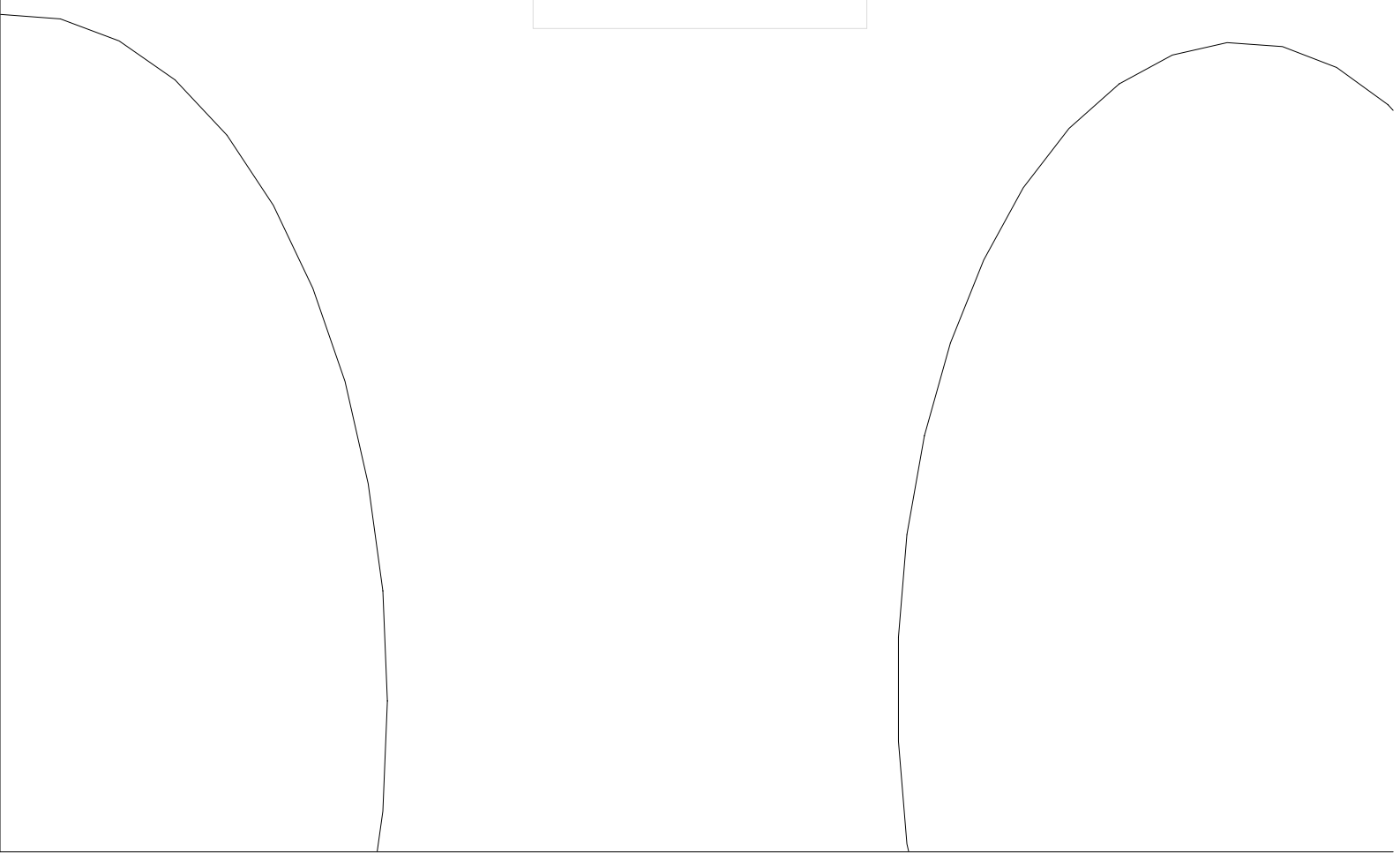

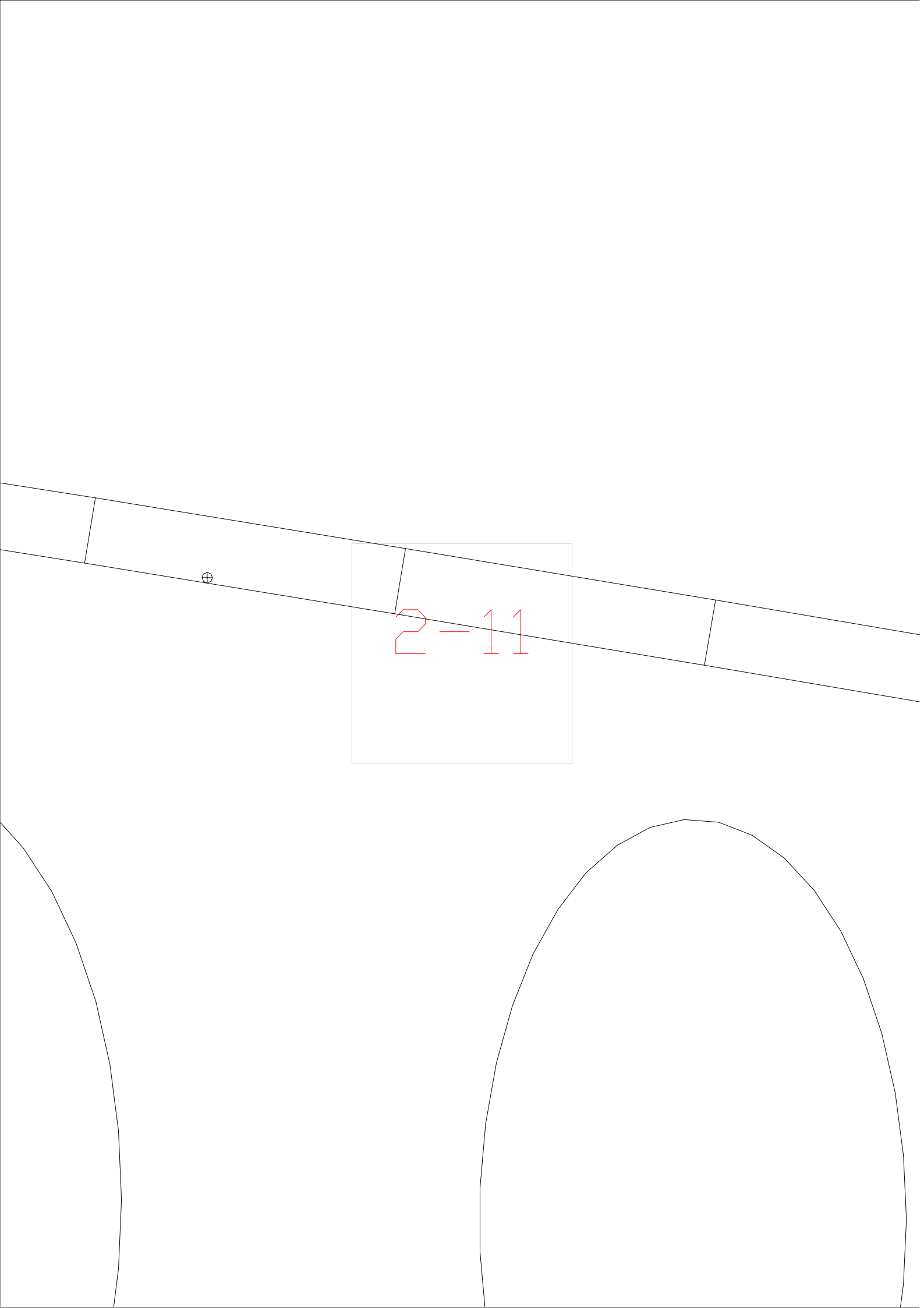

2-12



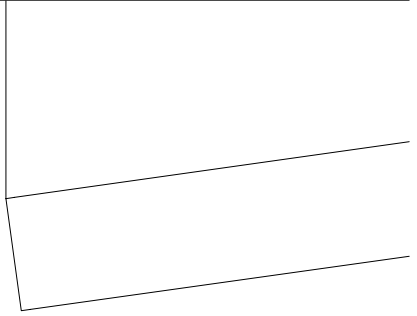

2-13

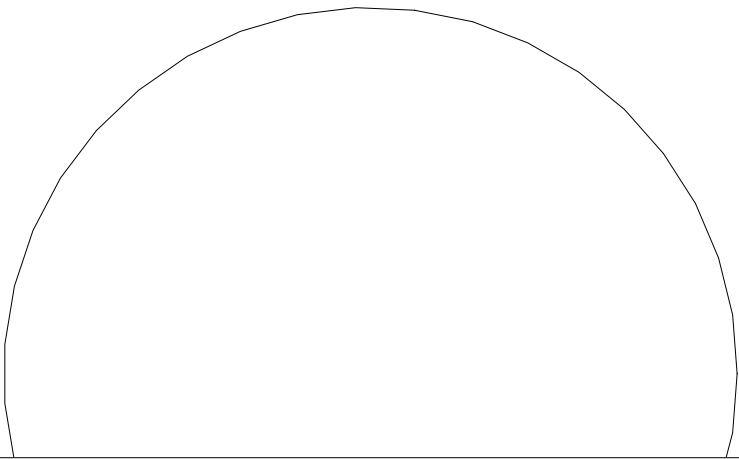
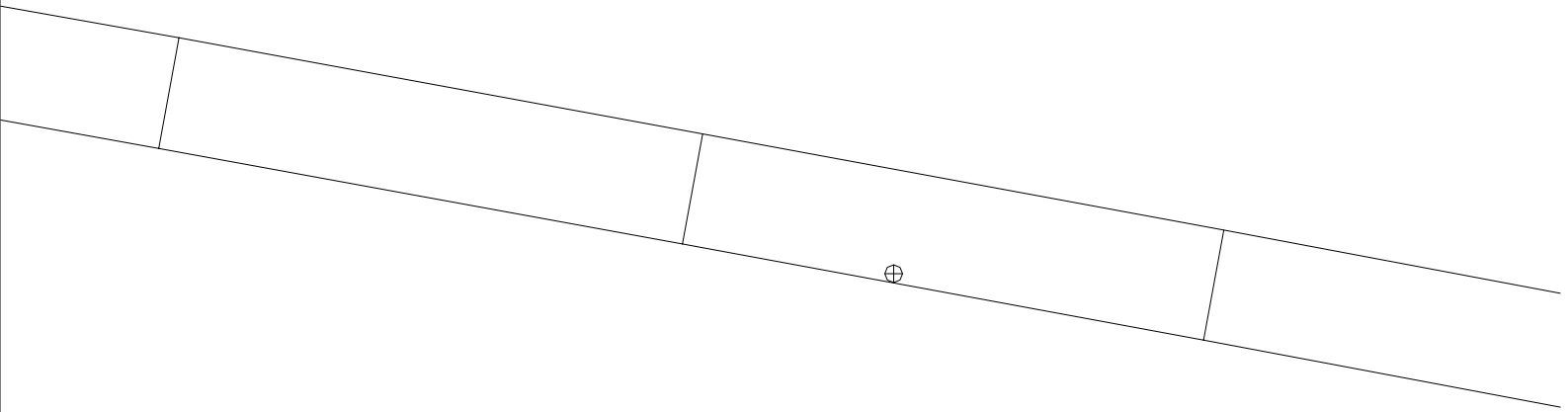

2-14

2-15

2-16

2-1

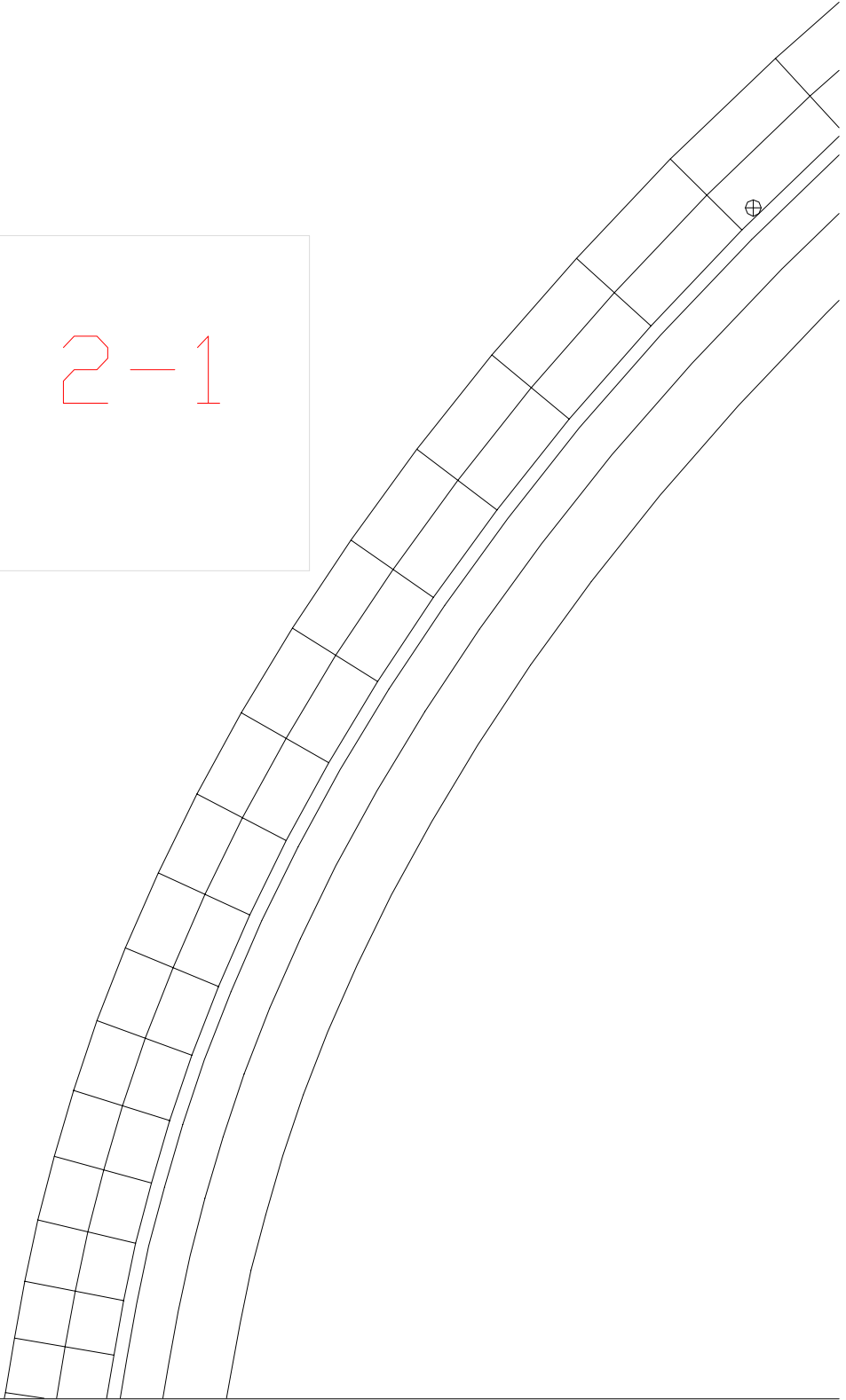

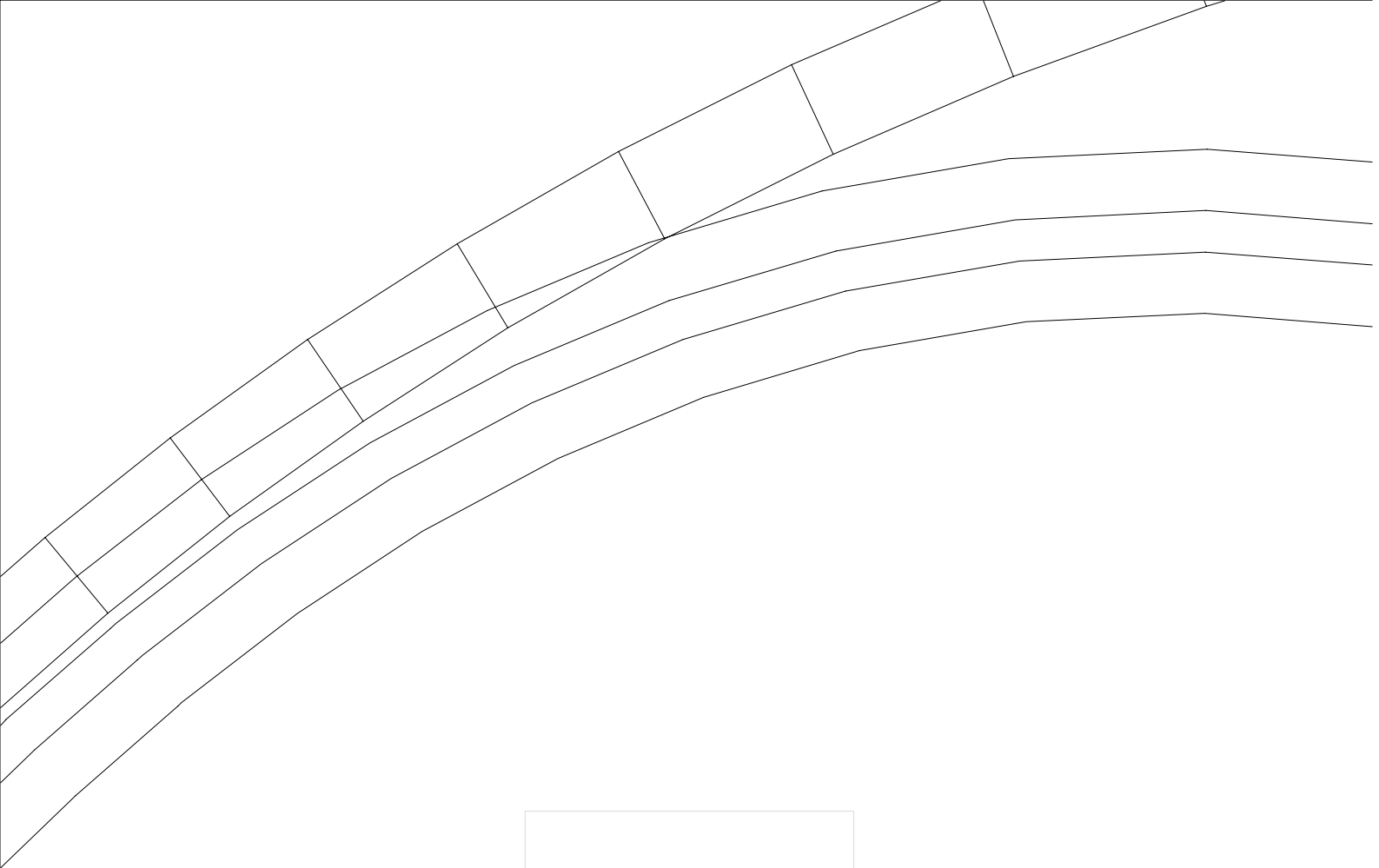

2-2



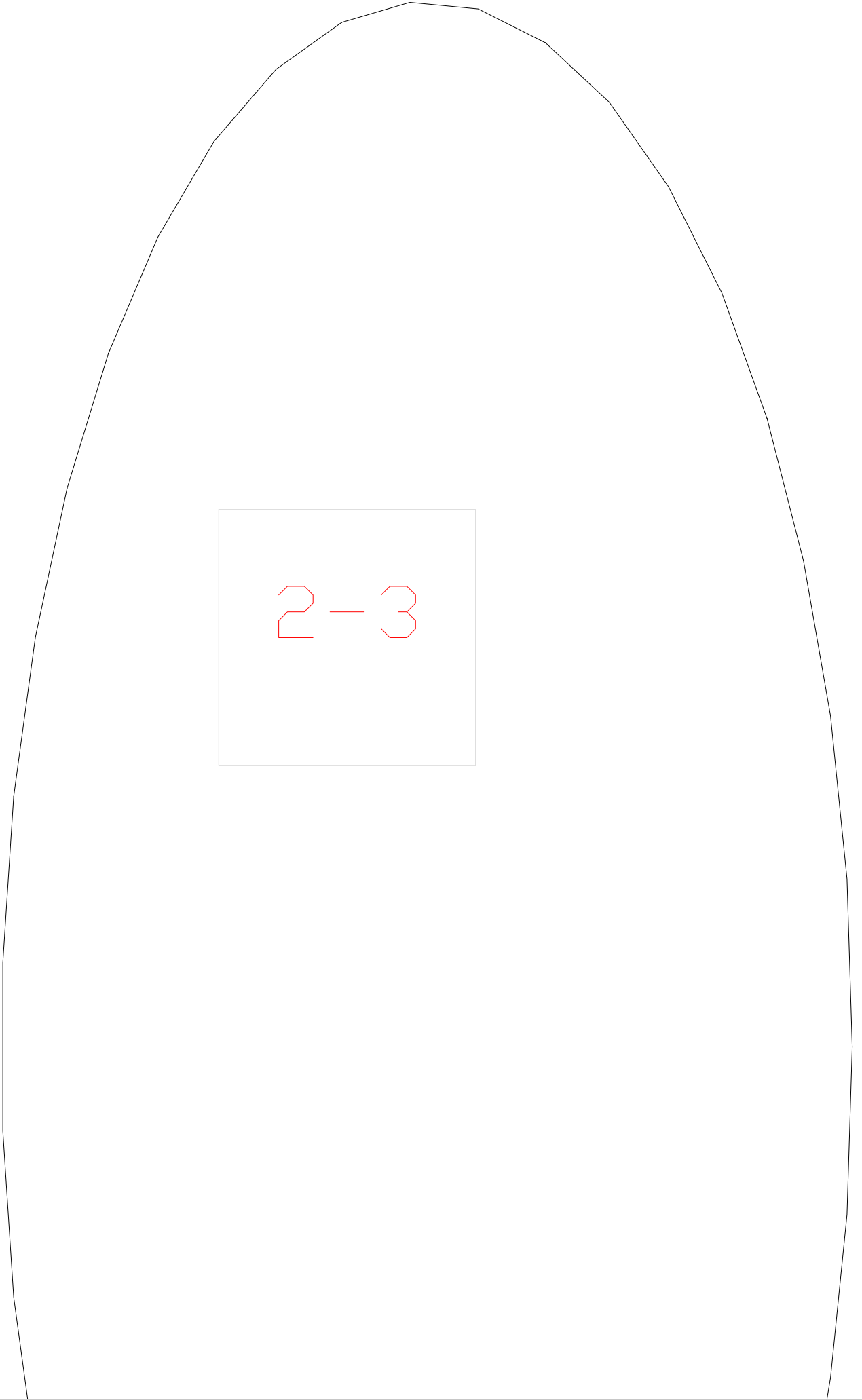

2-3

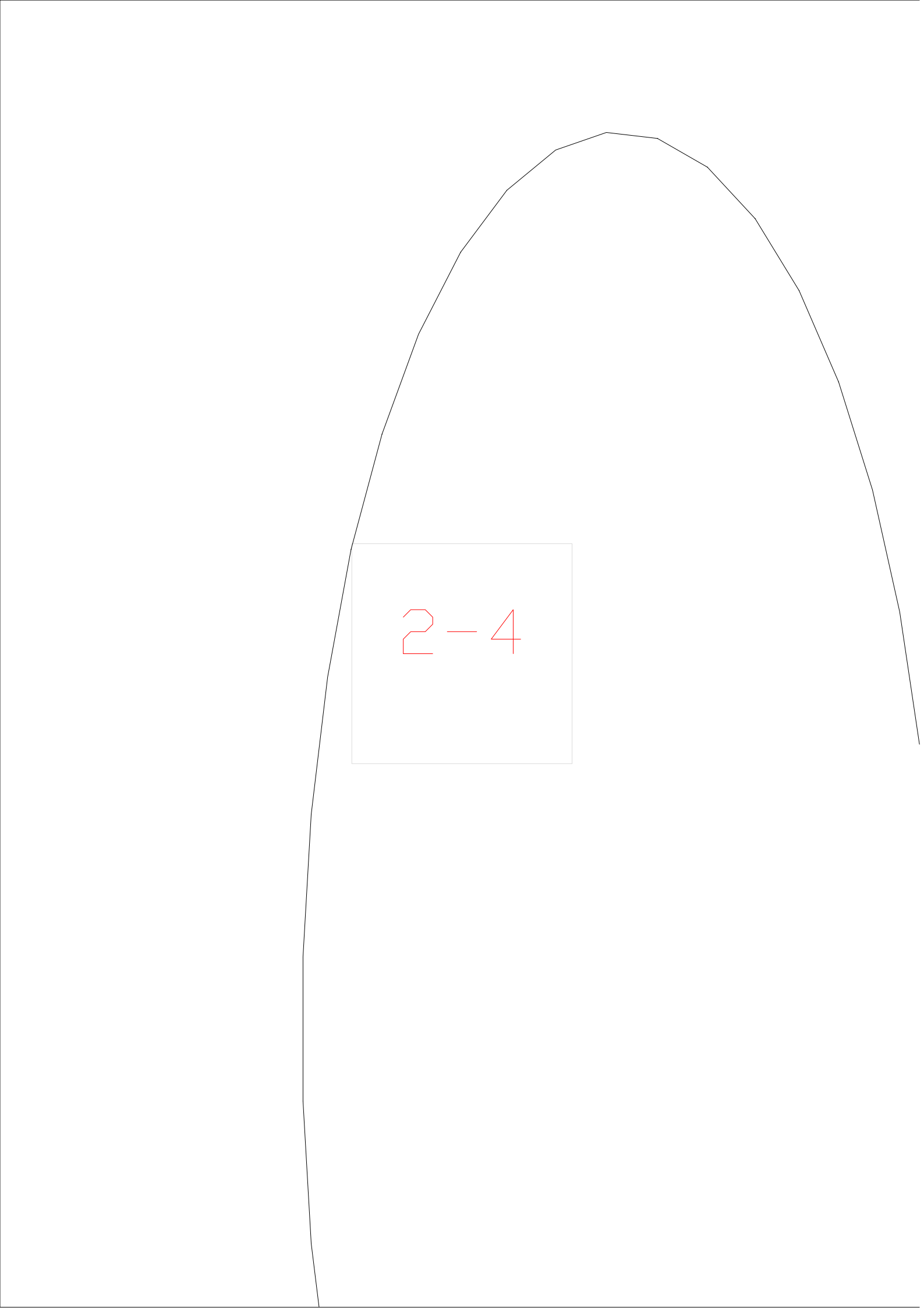

2-4

2-5

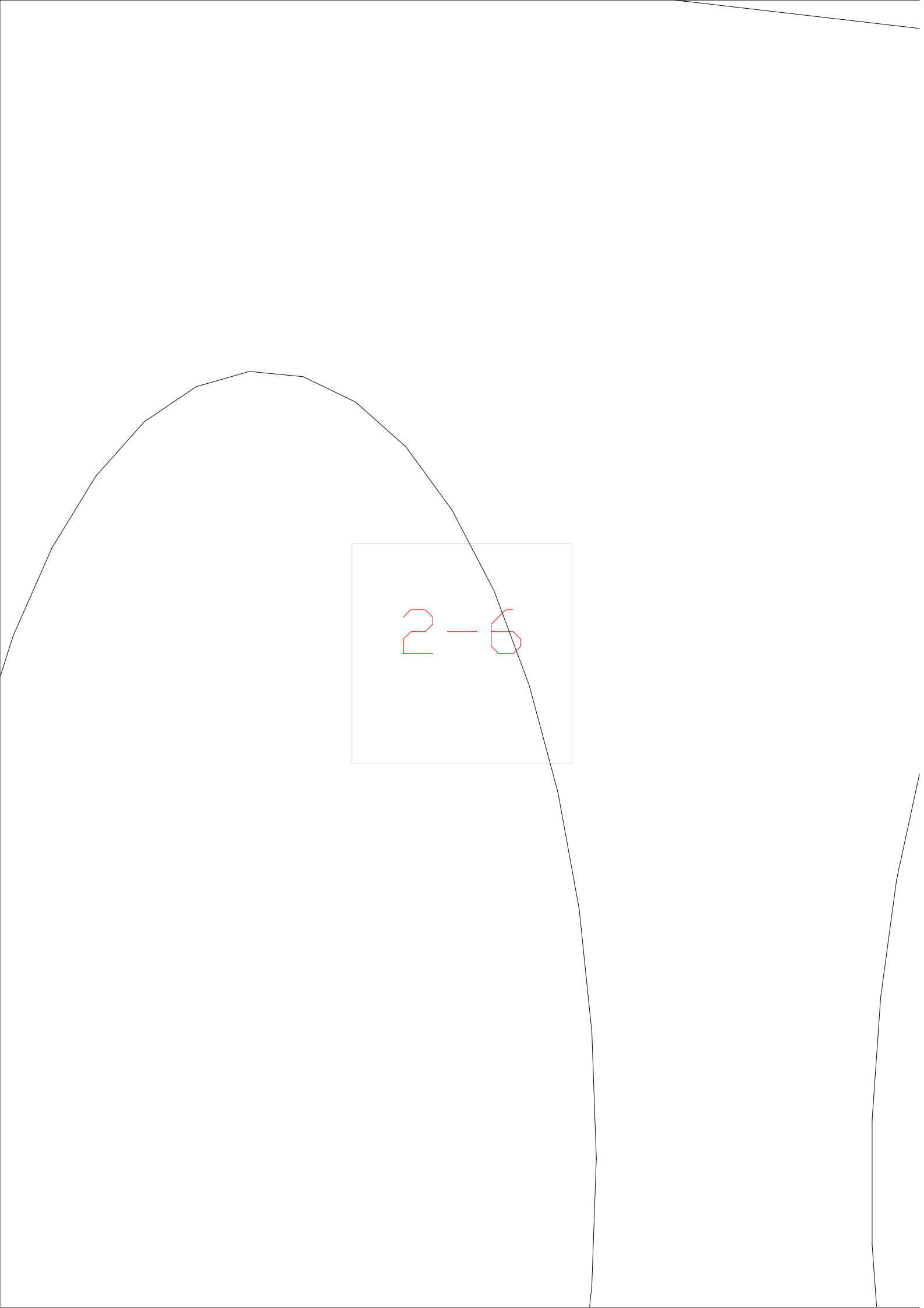

2-6

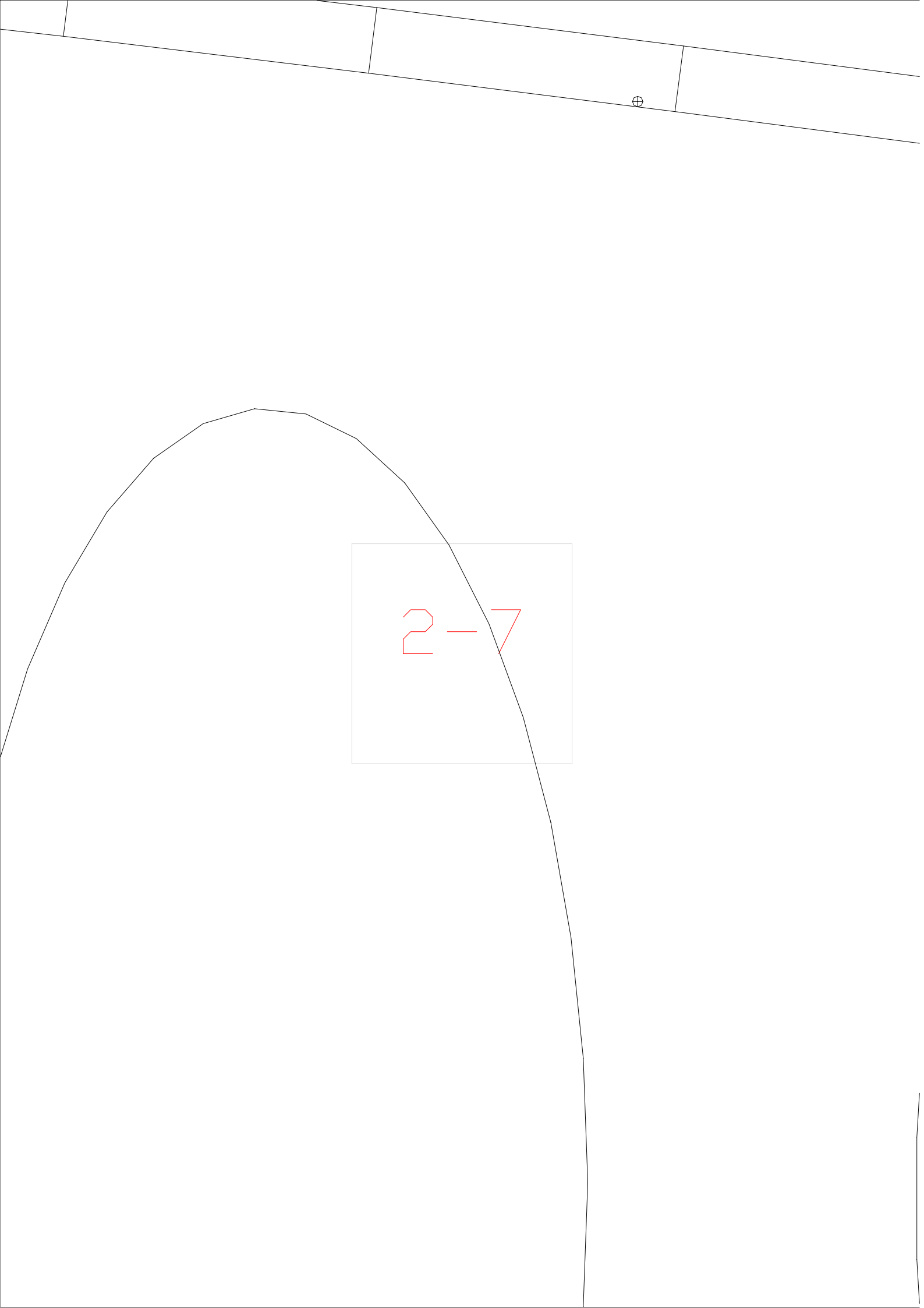

2-7

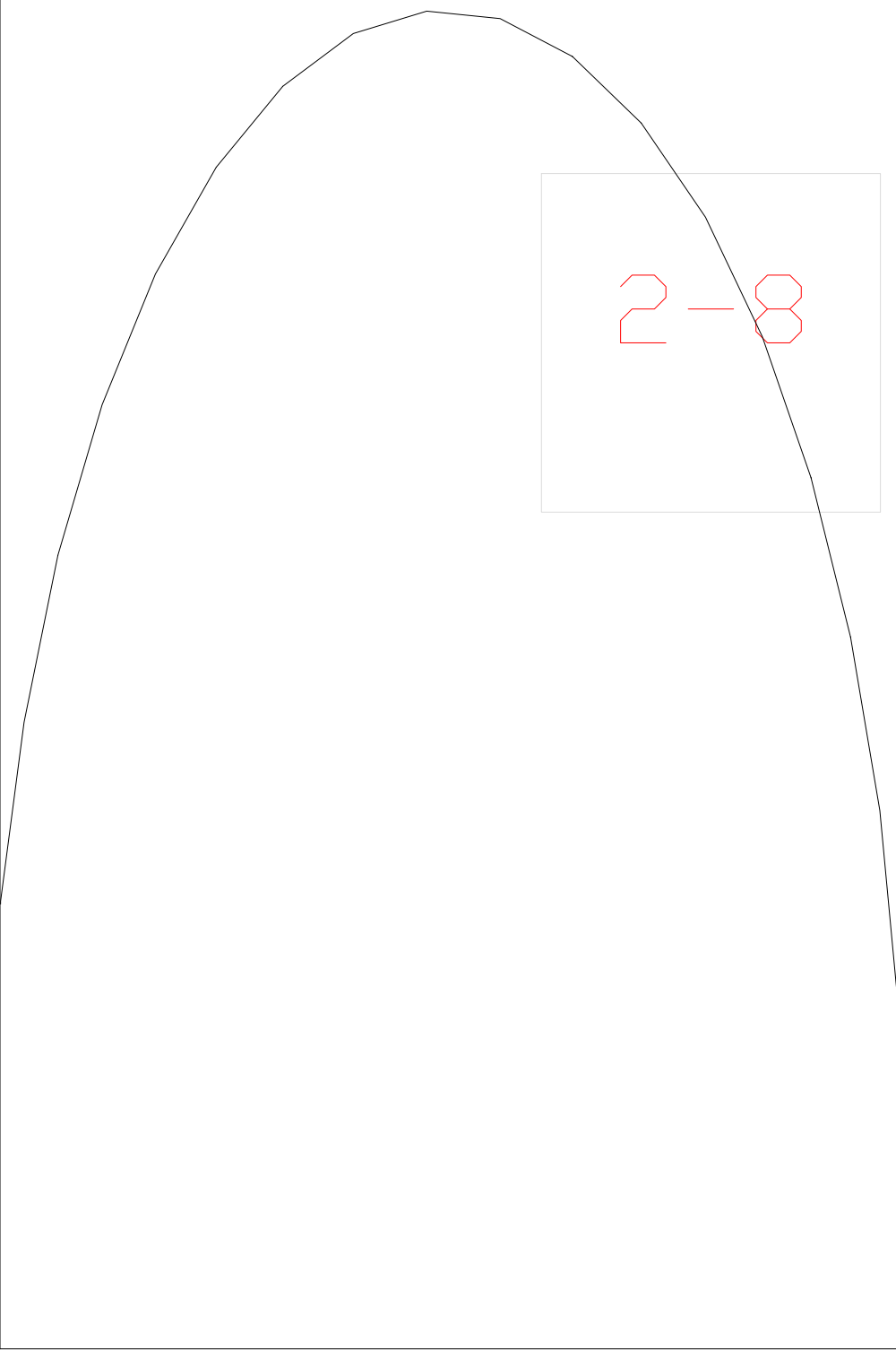
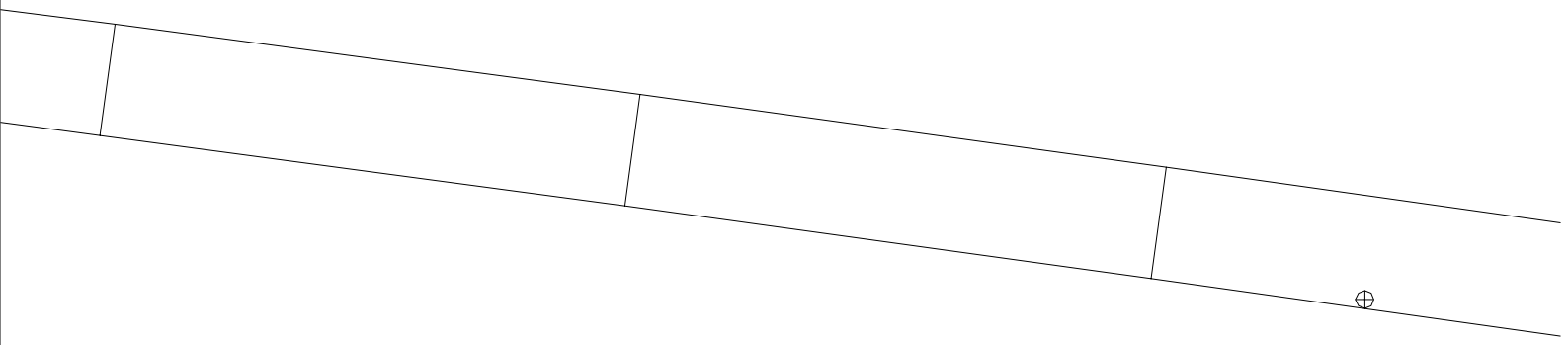

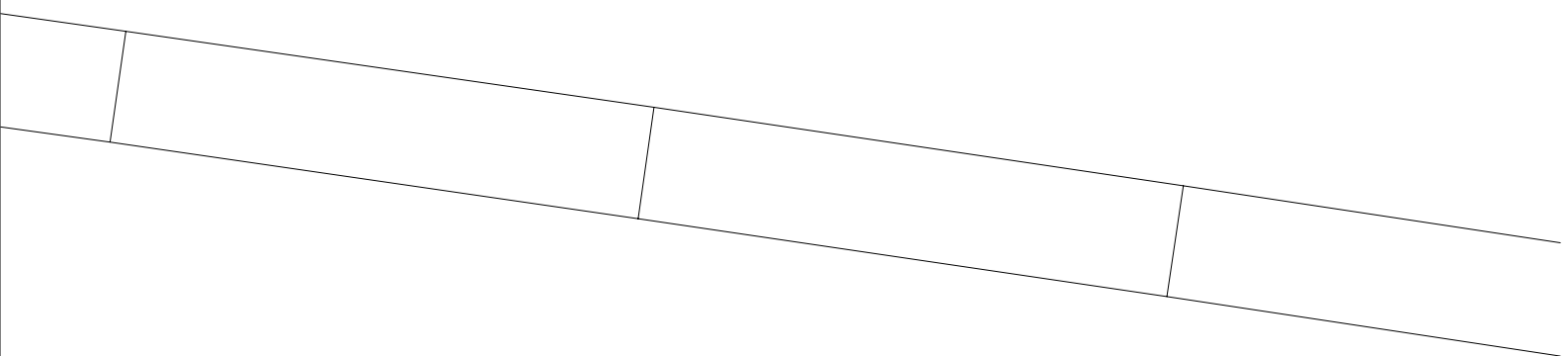

2-9

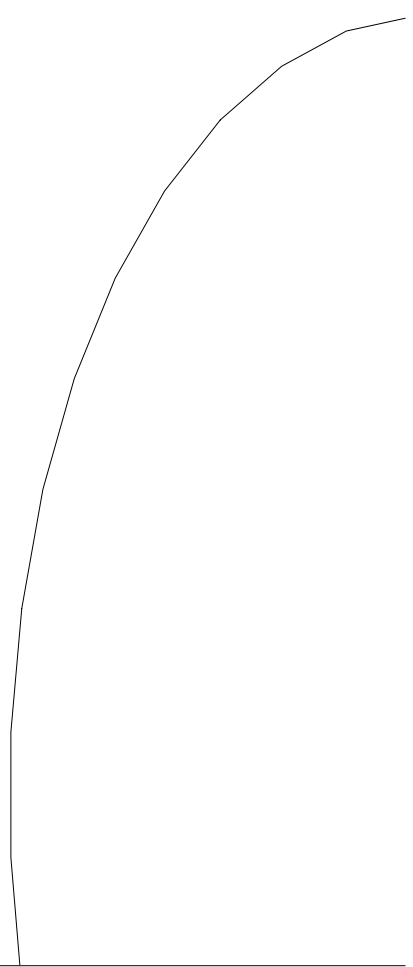

3-10

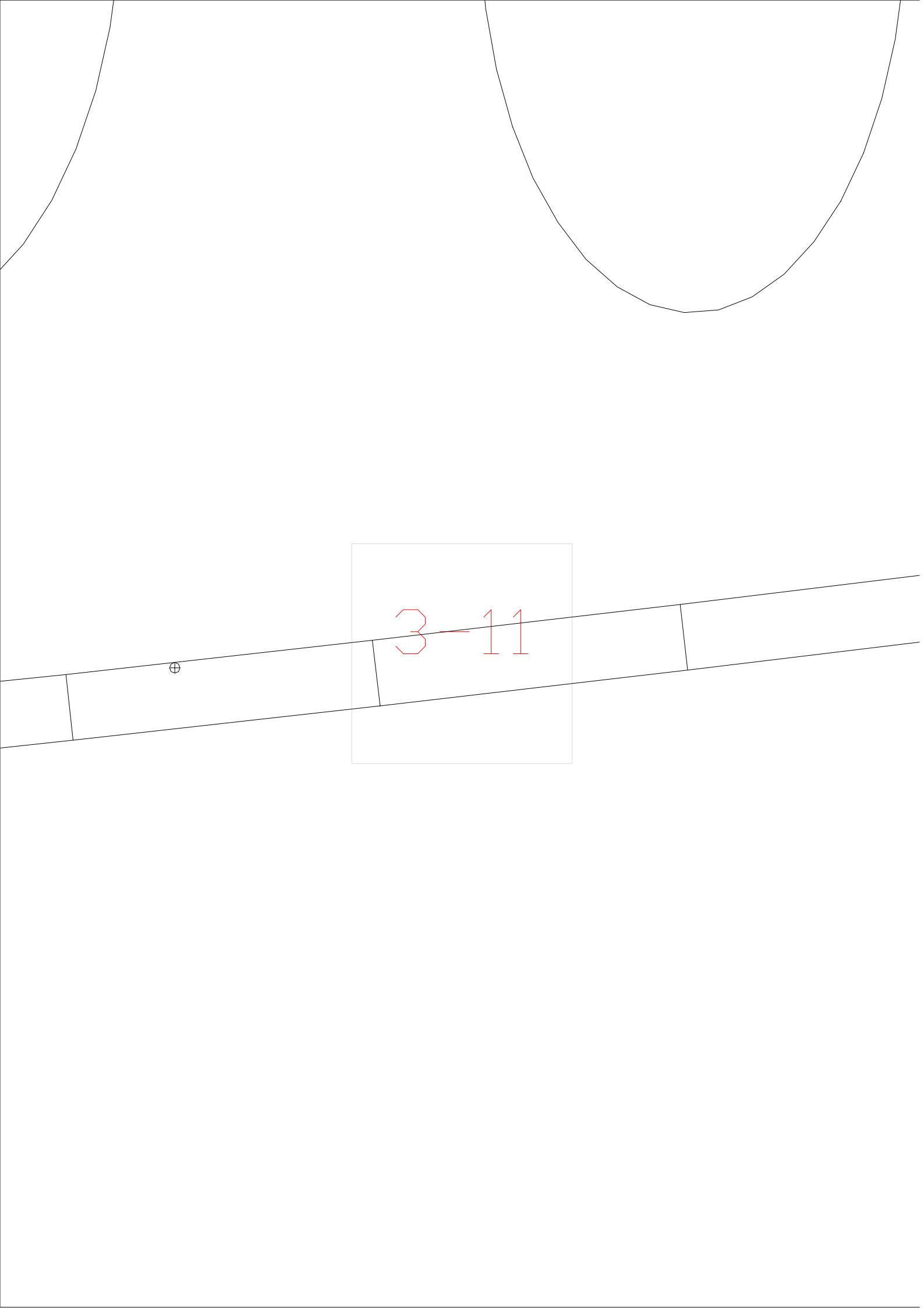

3-11

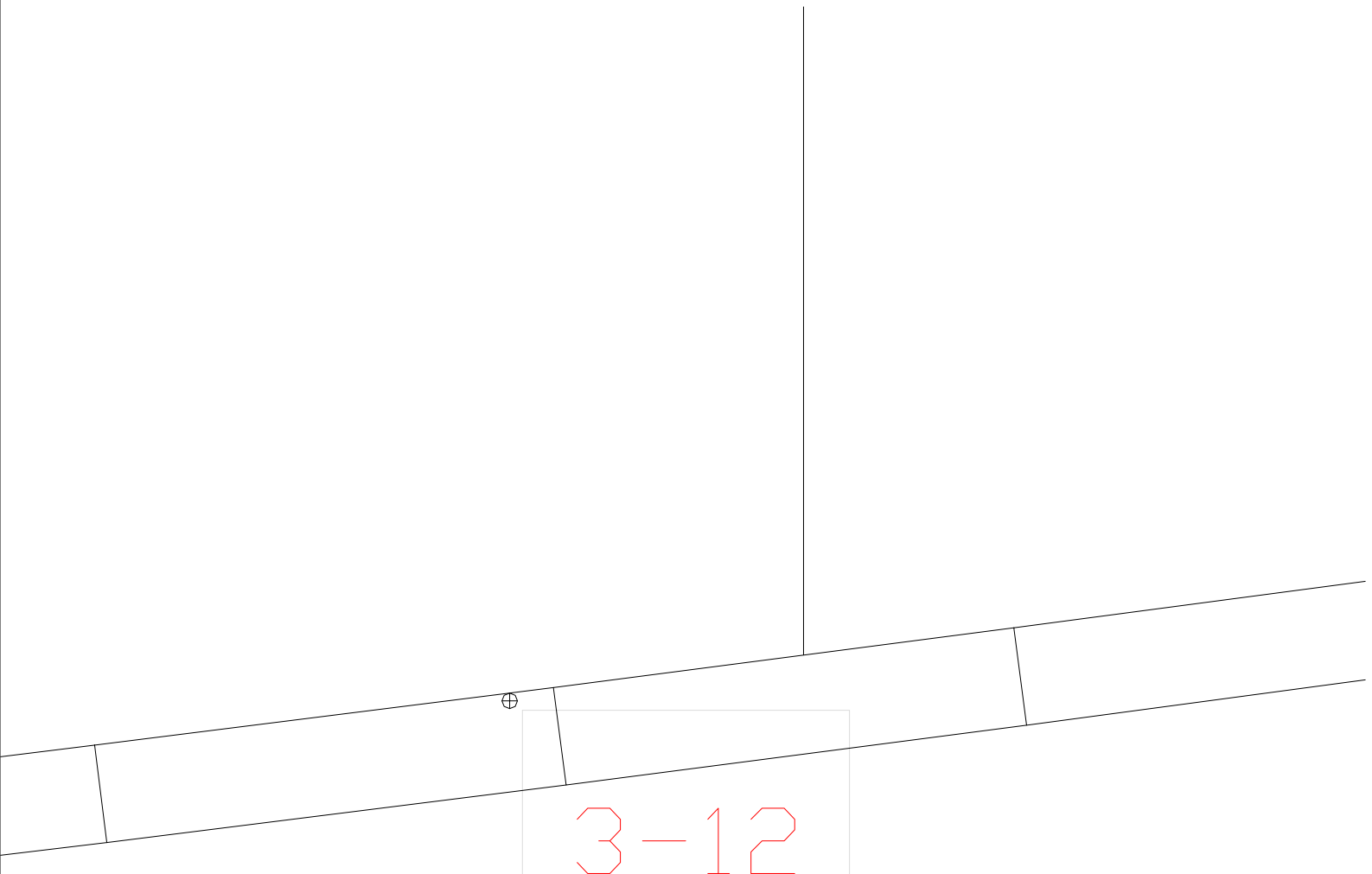

3-12

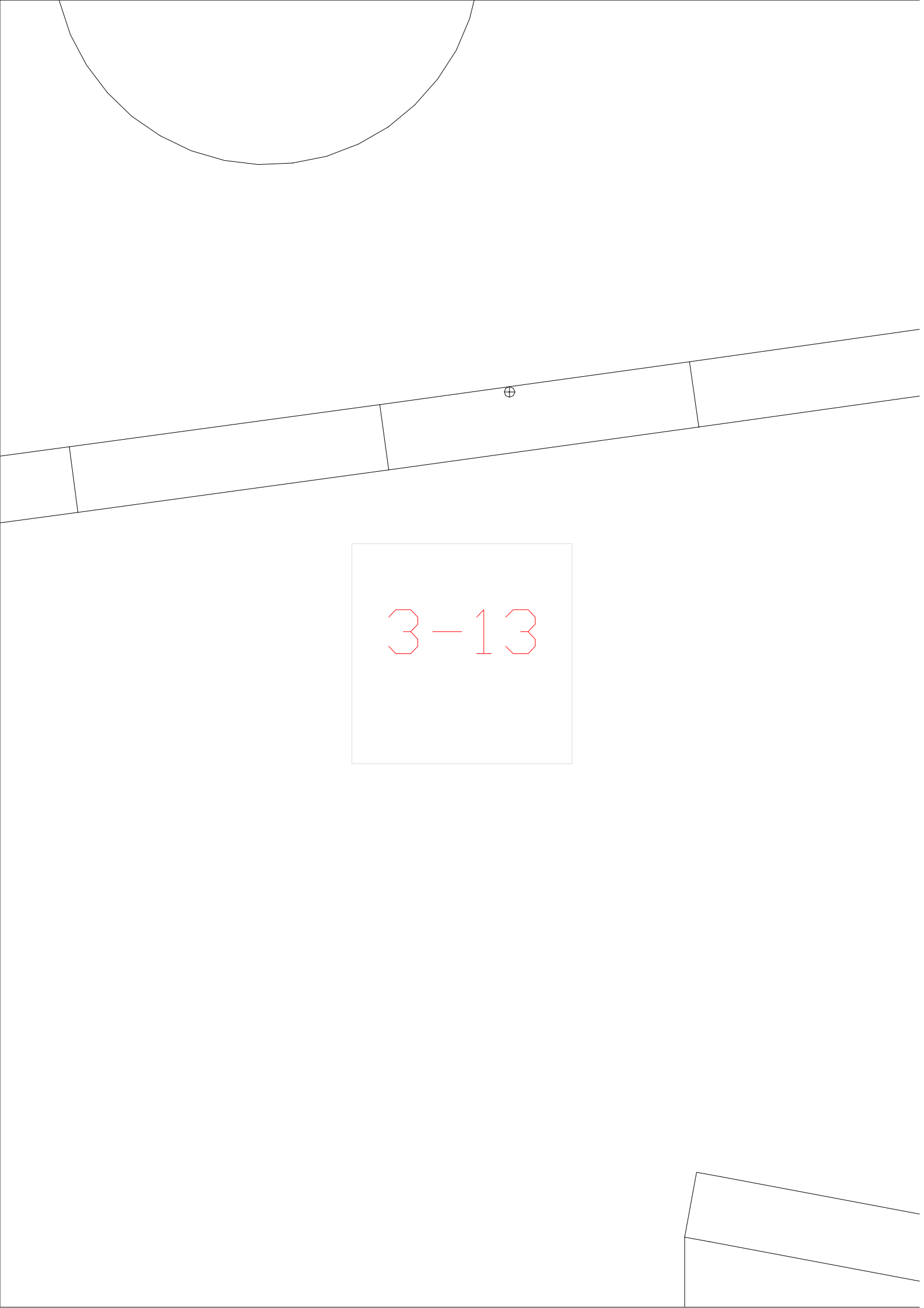

3-13

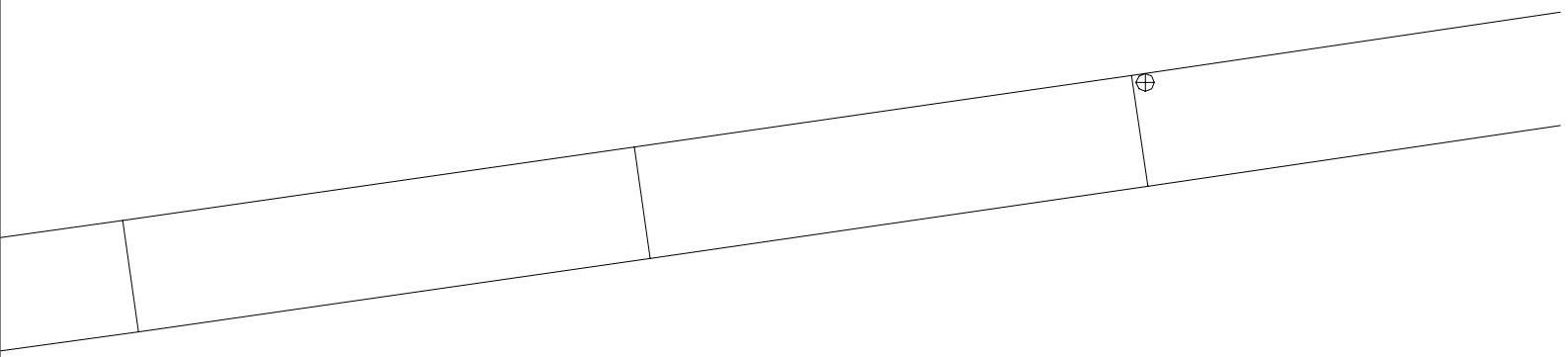

3-14

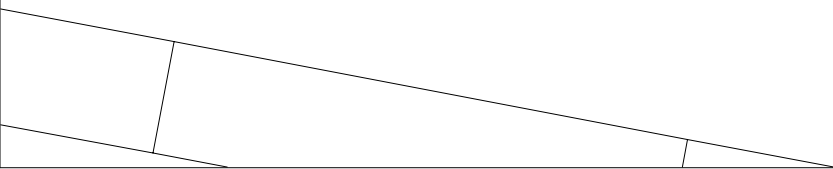

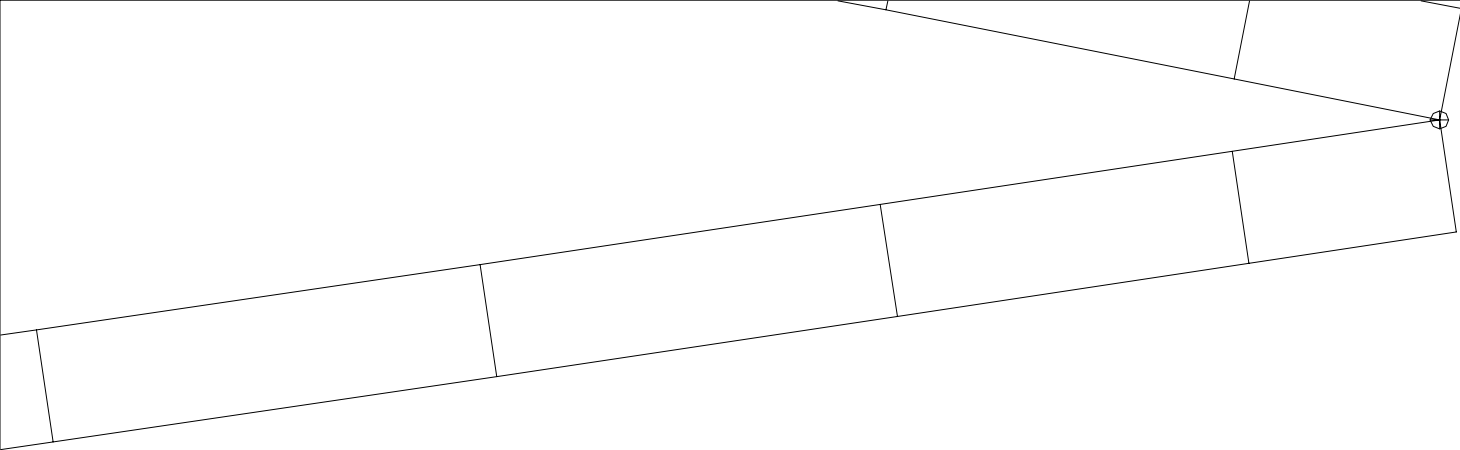

3-15

3-16

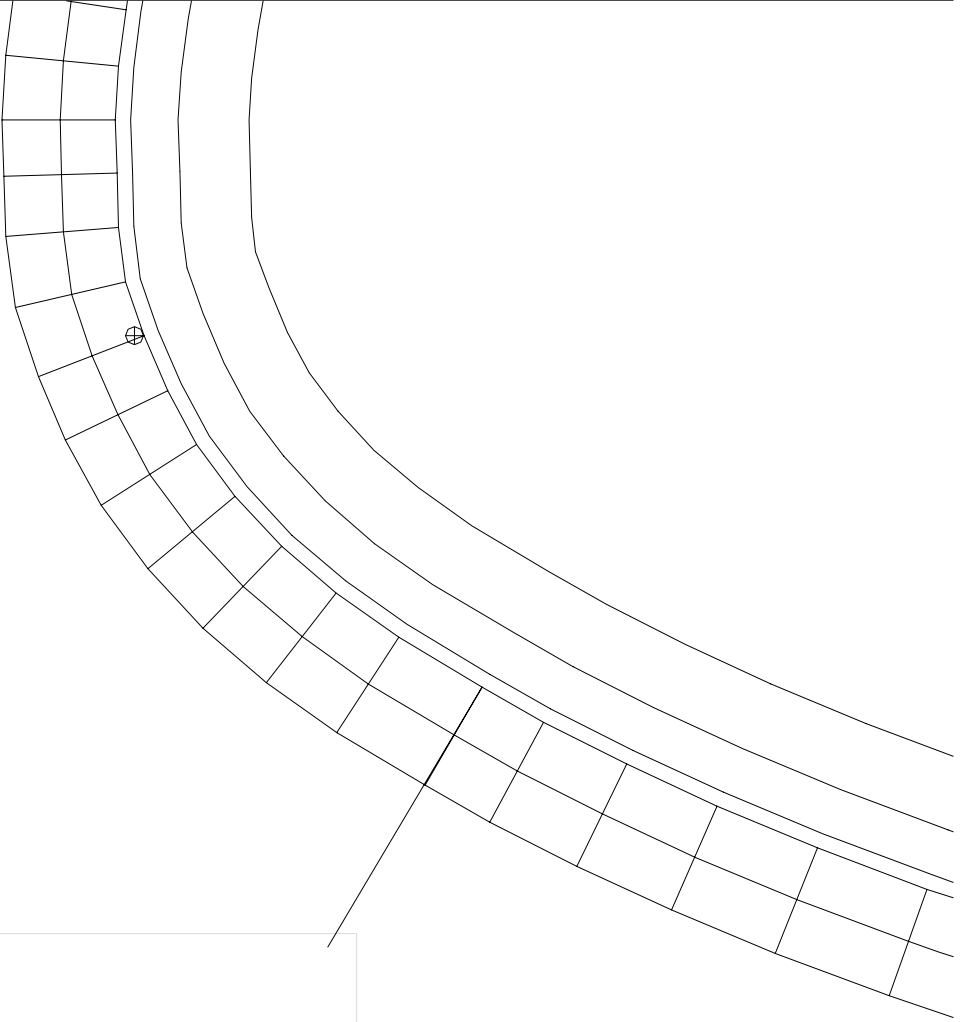

3-1

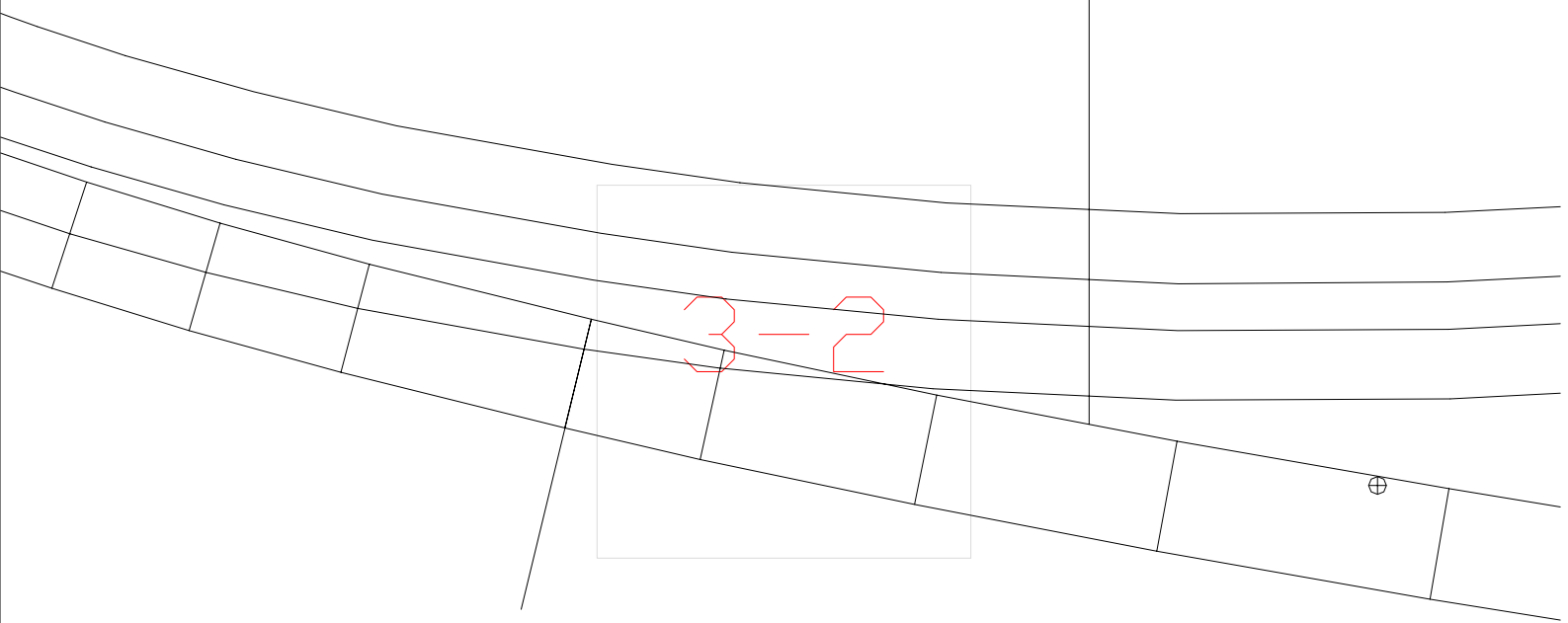
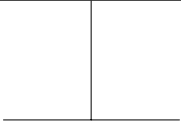

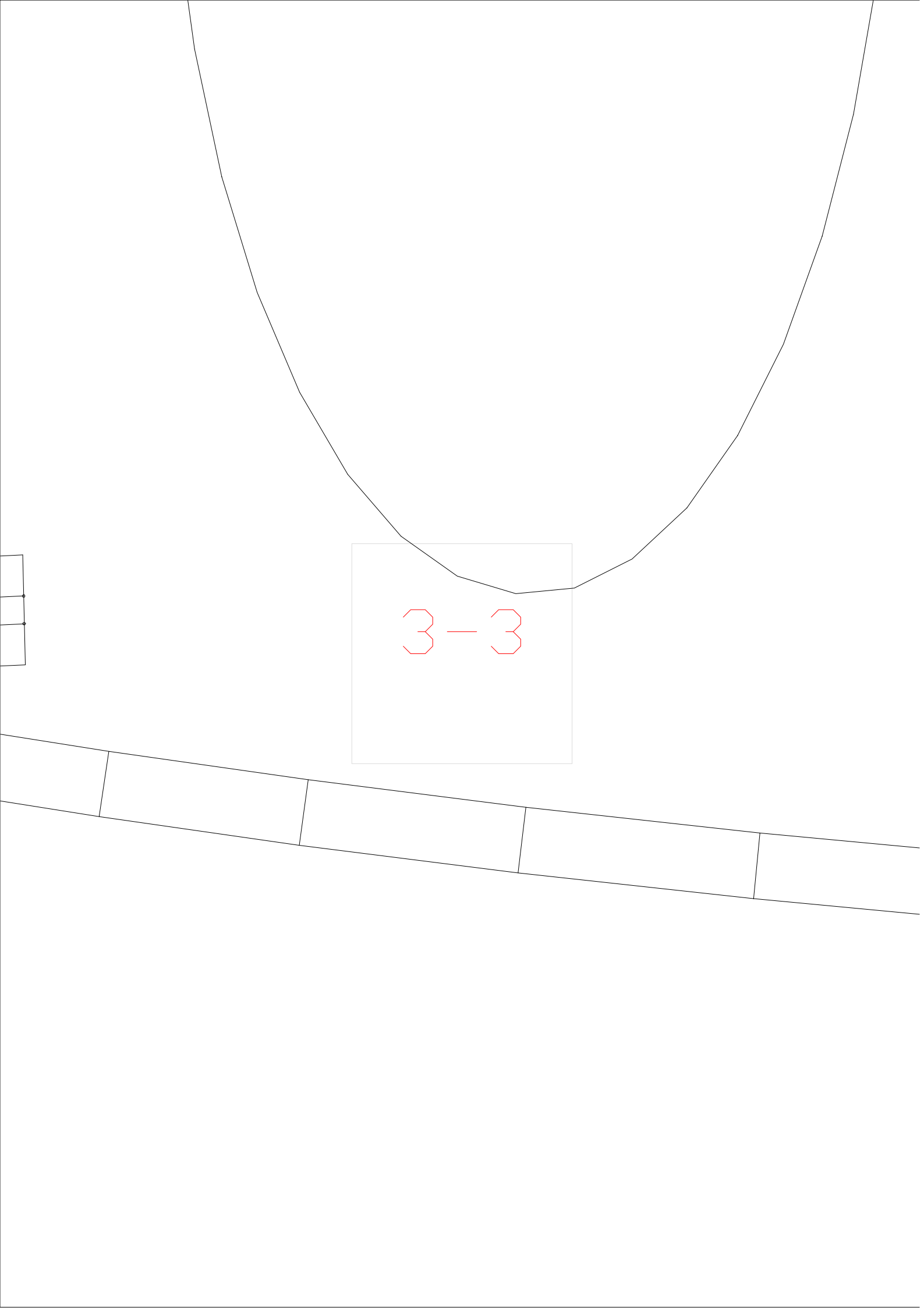

3-3

3-4

⊕

3-5

⊕

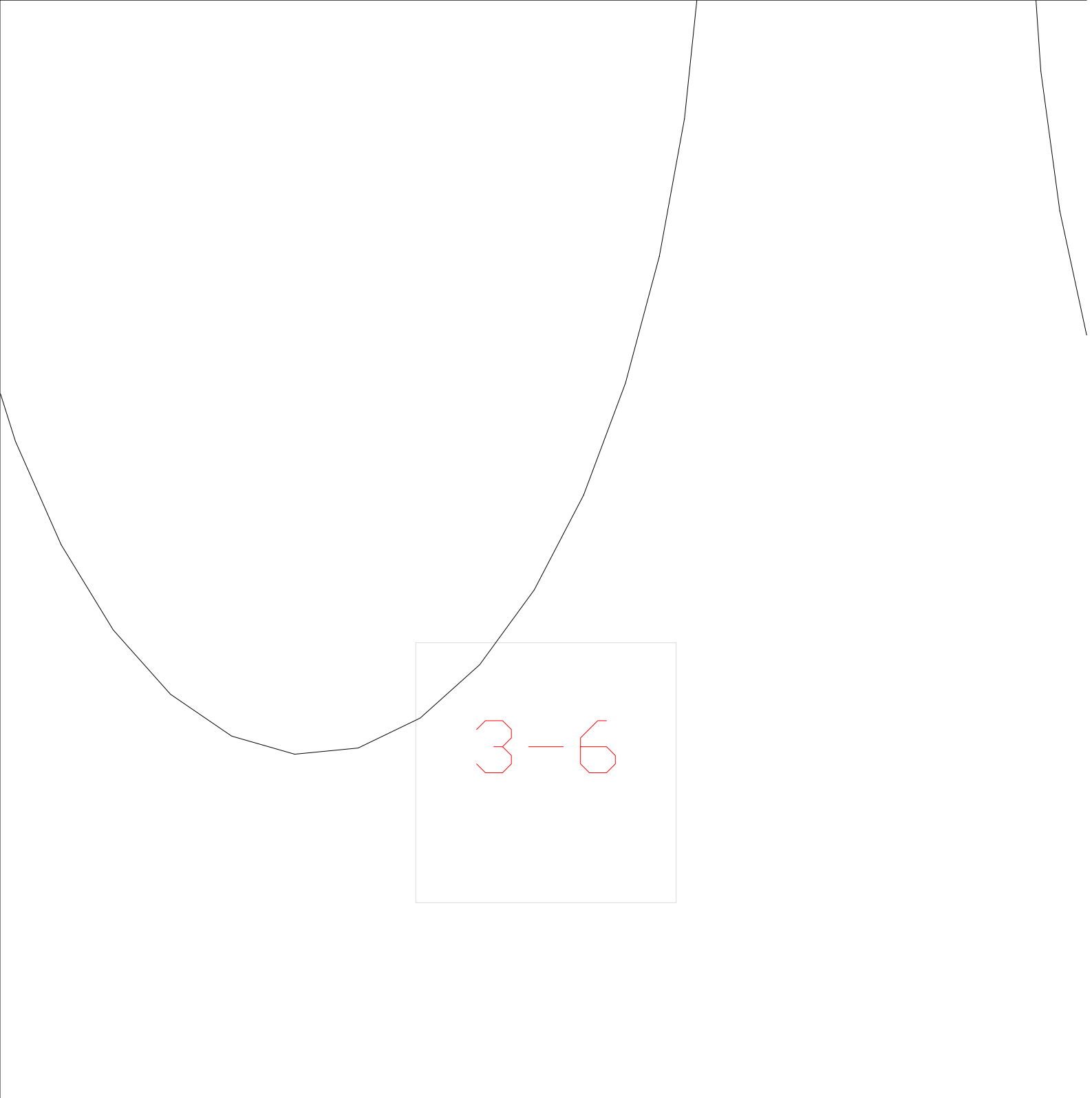

		⊕		
--	--	---	--	--

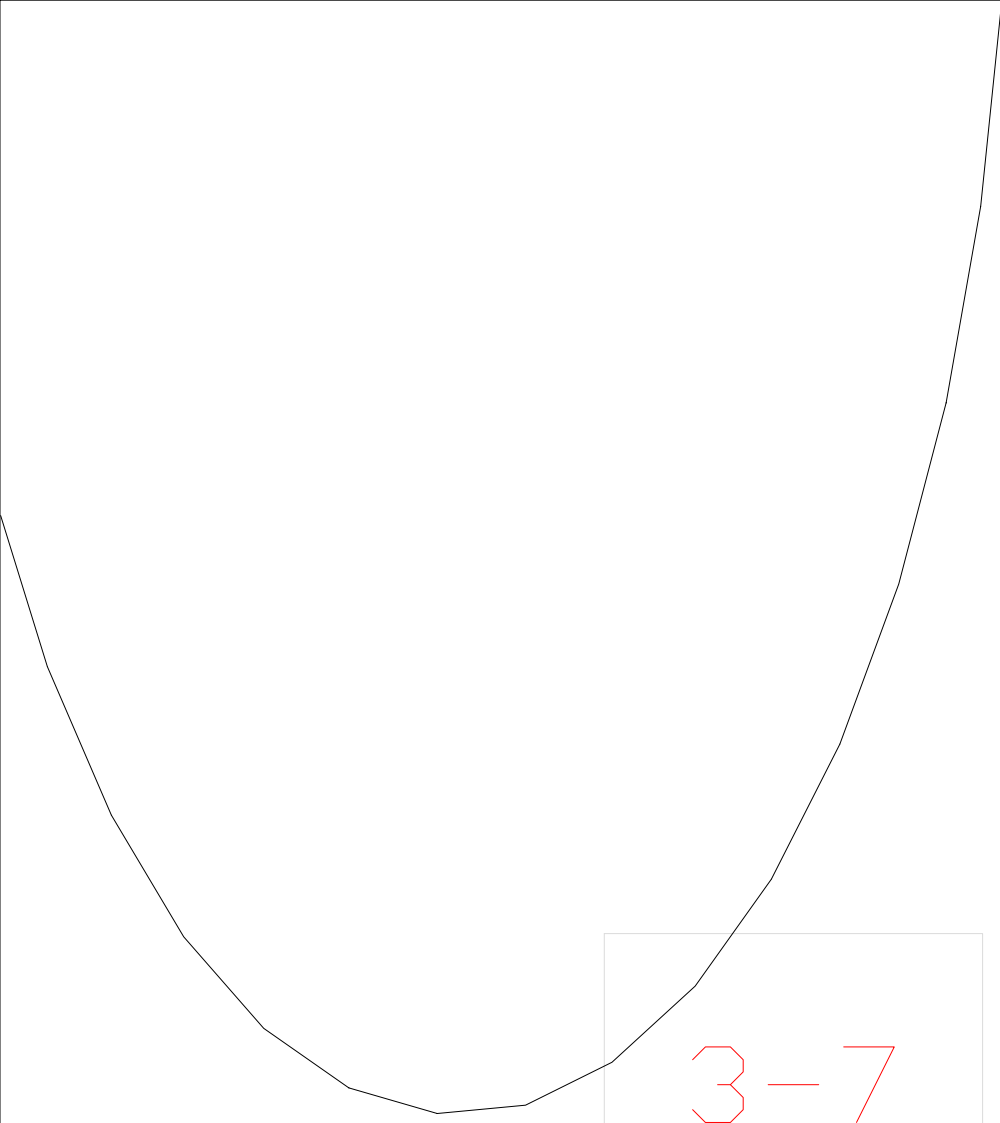

3-7

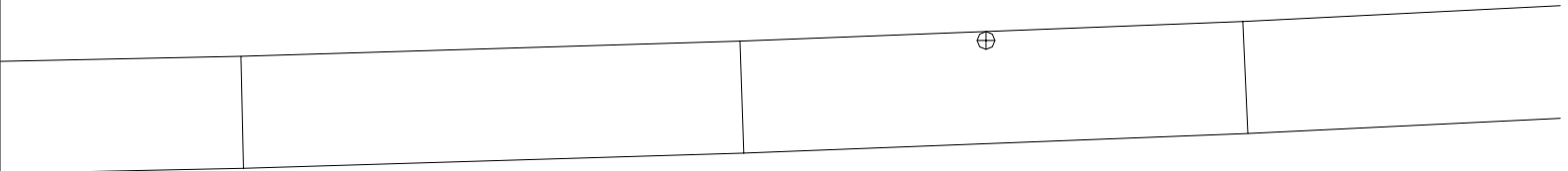

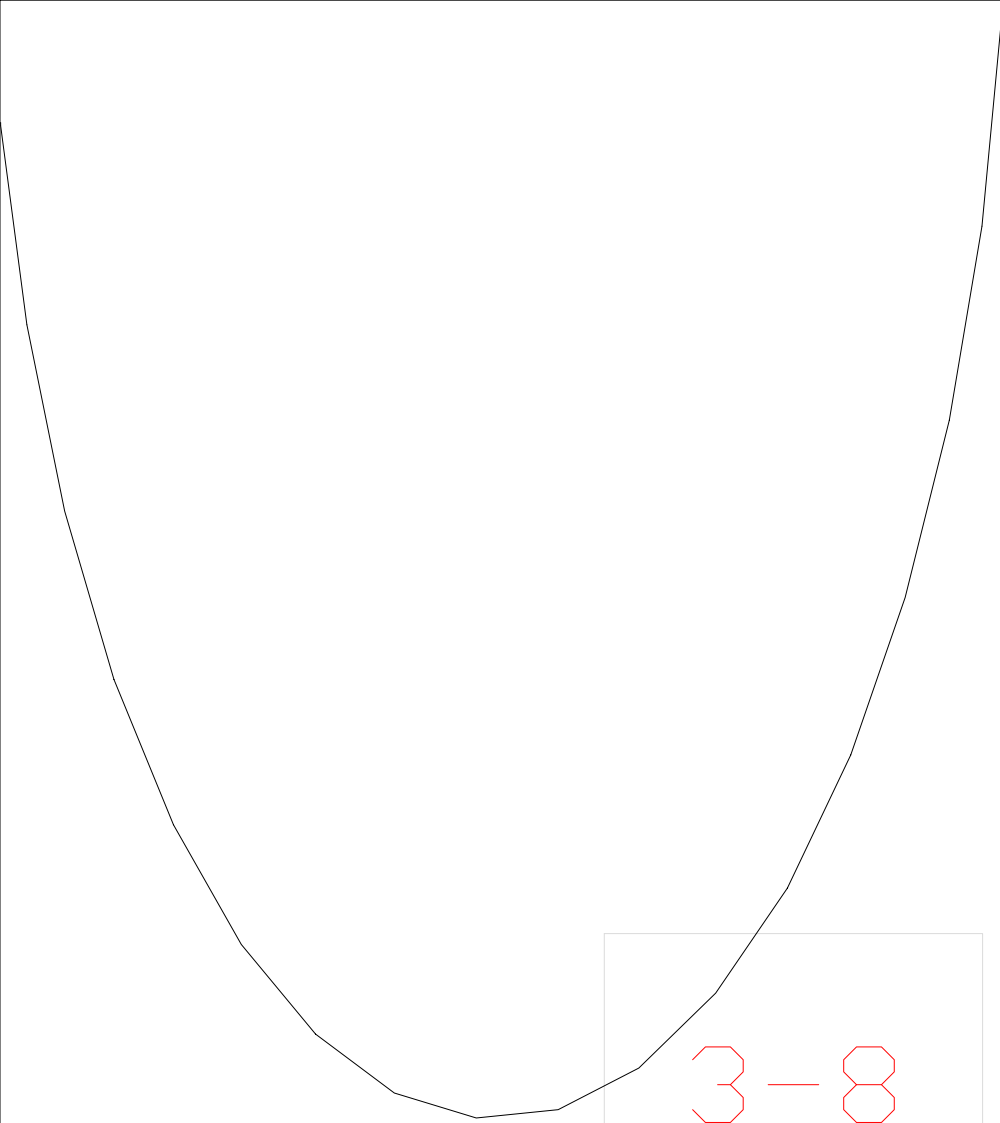

3-8

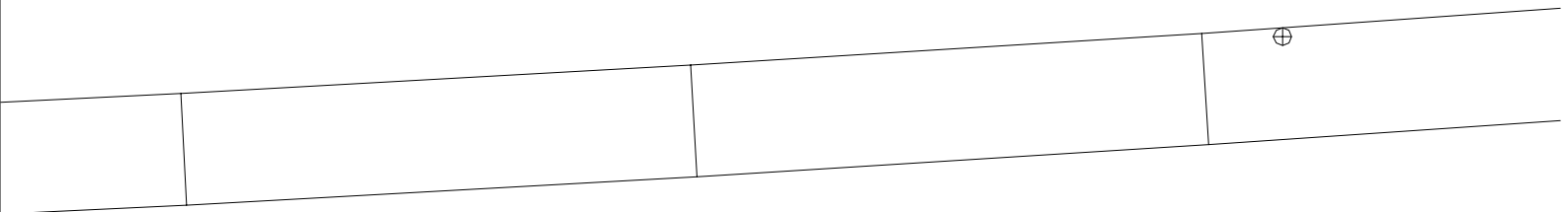

3-9

4-10

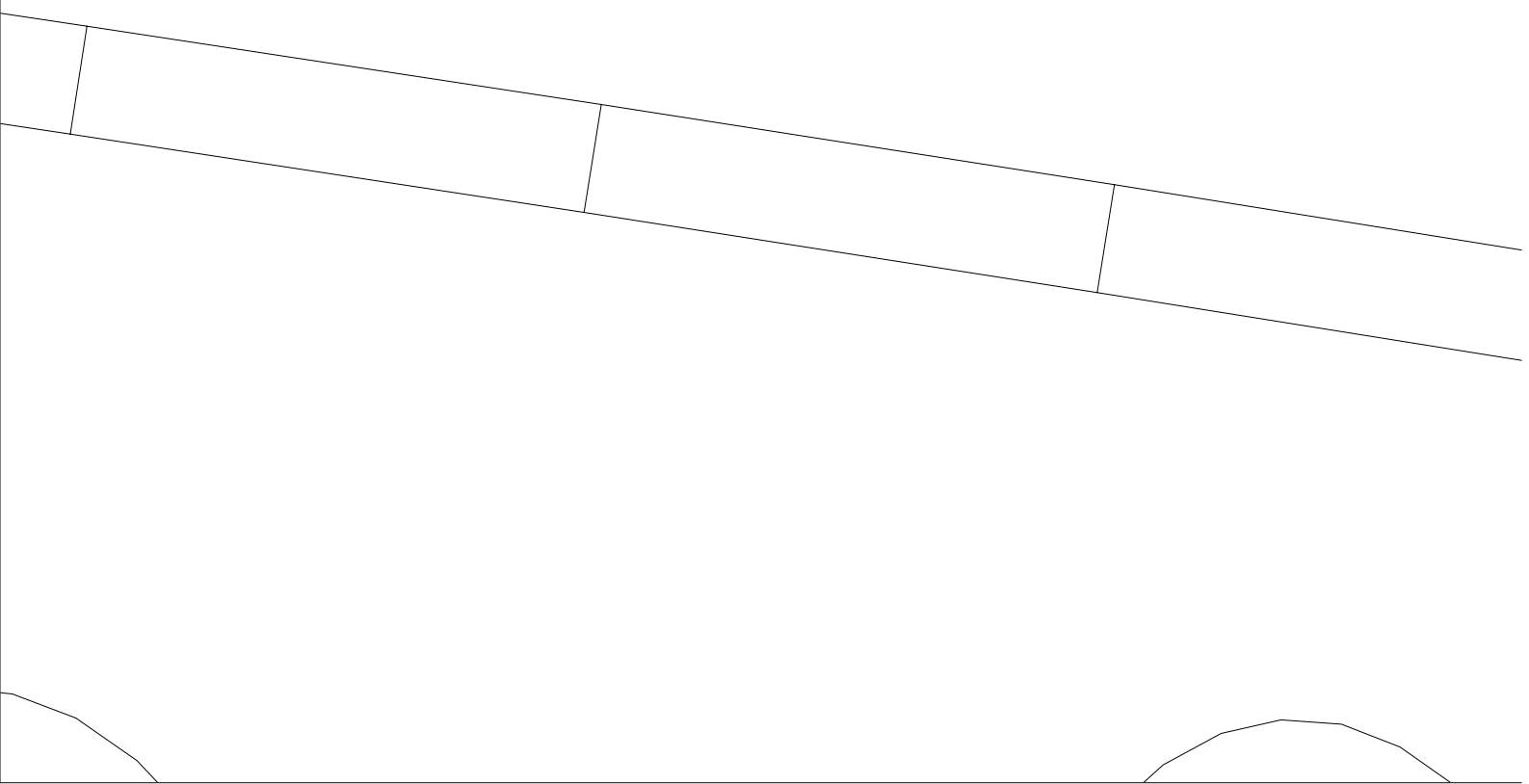

4-11

⊕

4-12

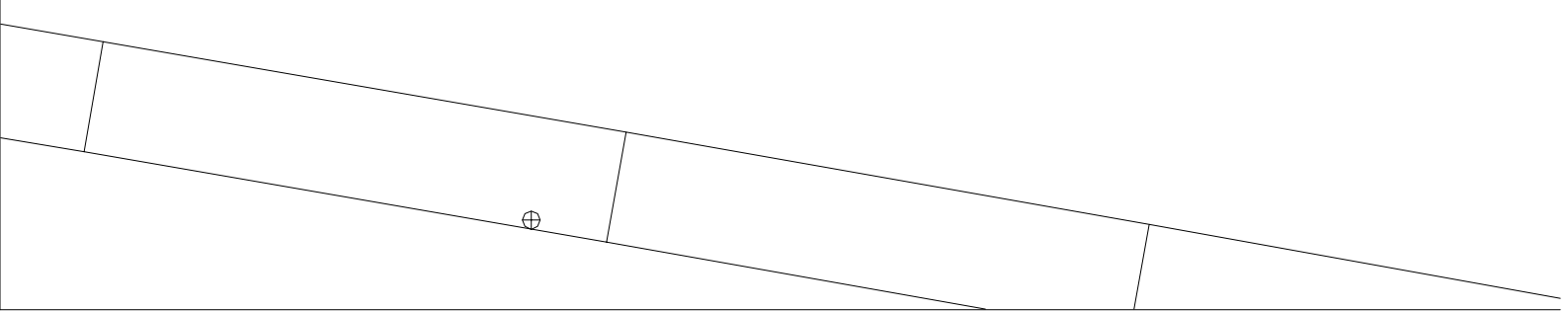

4-13

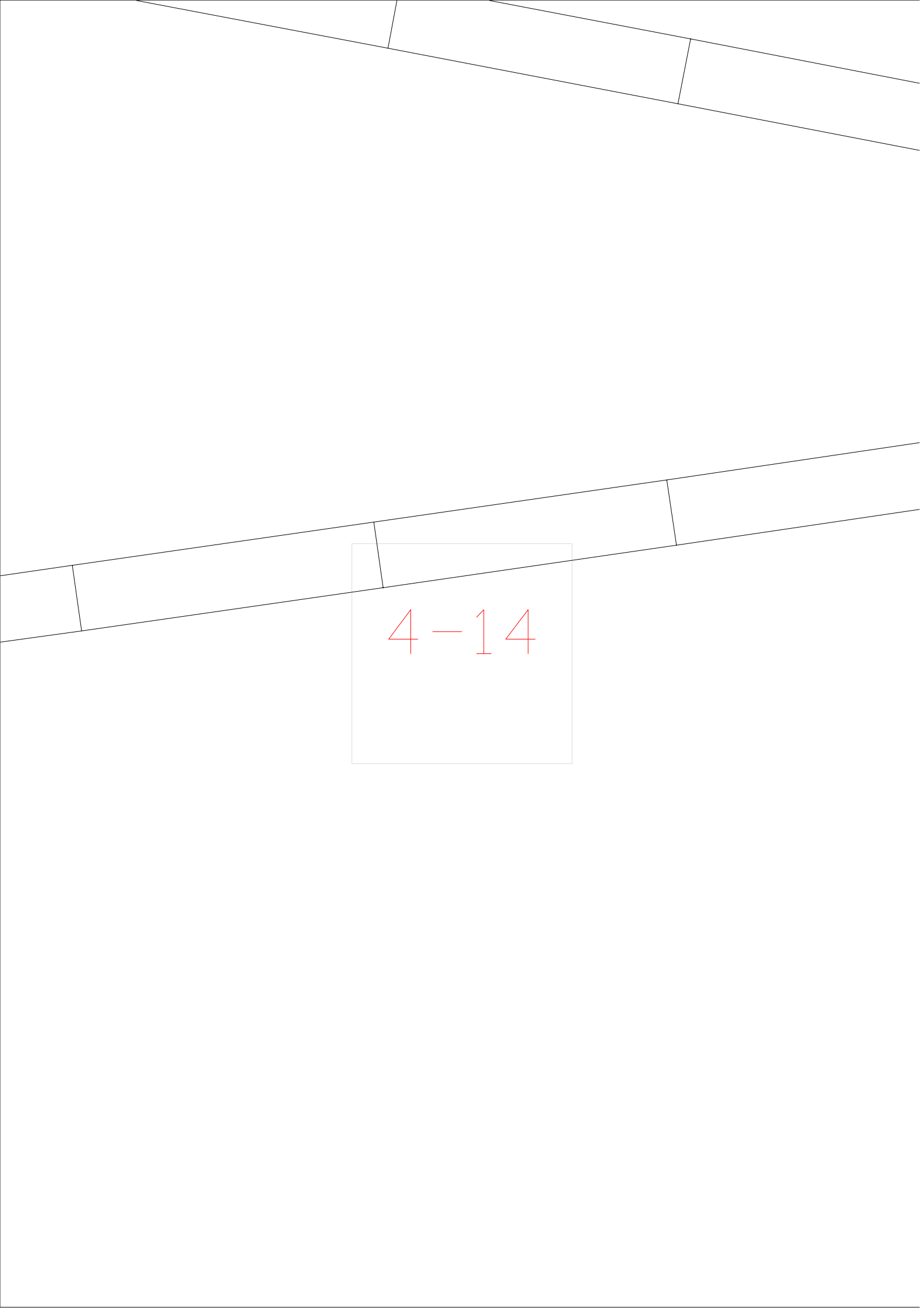

4-14

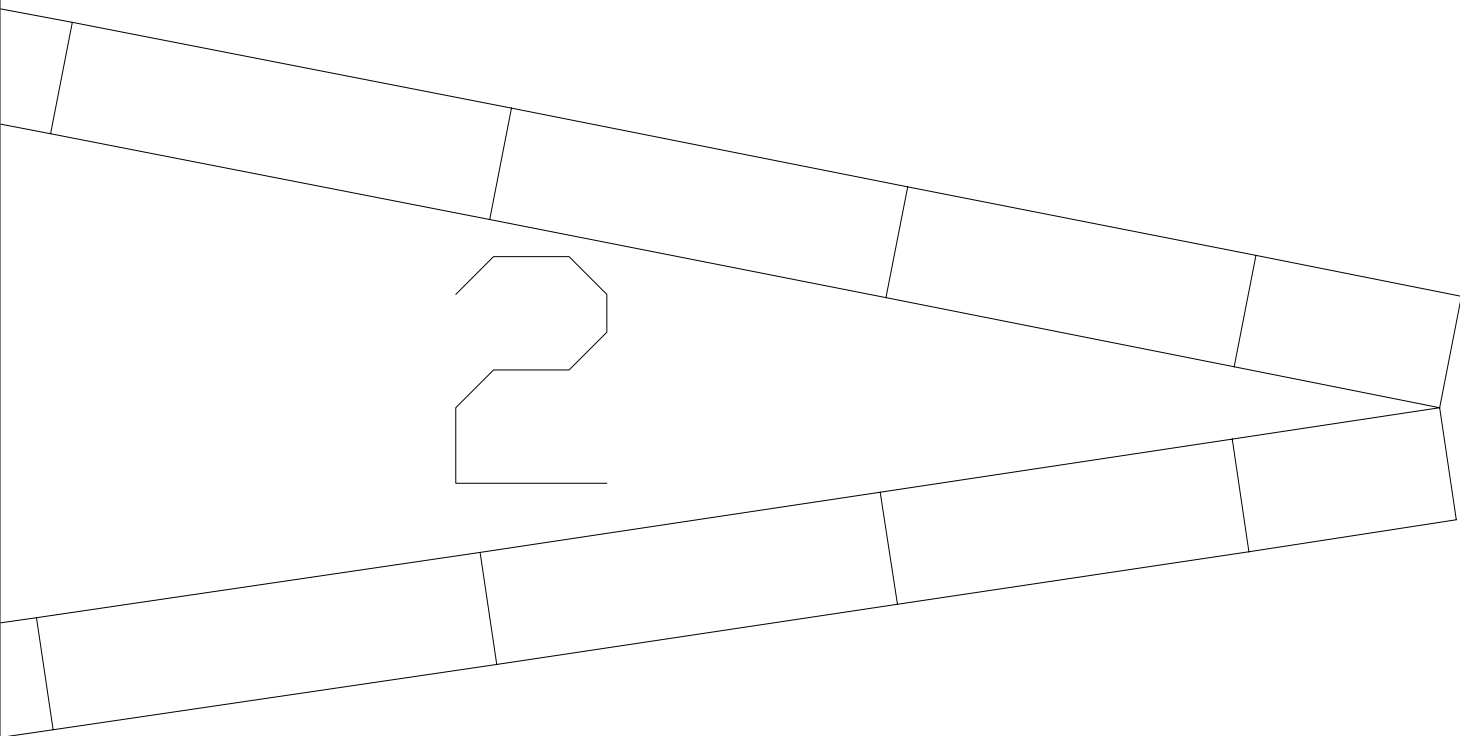

4-15

4-16

4-1

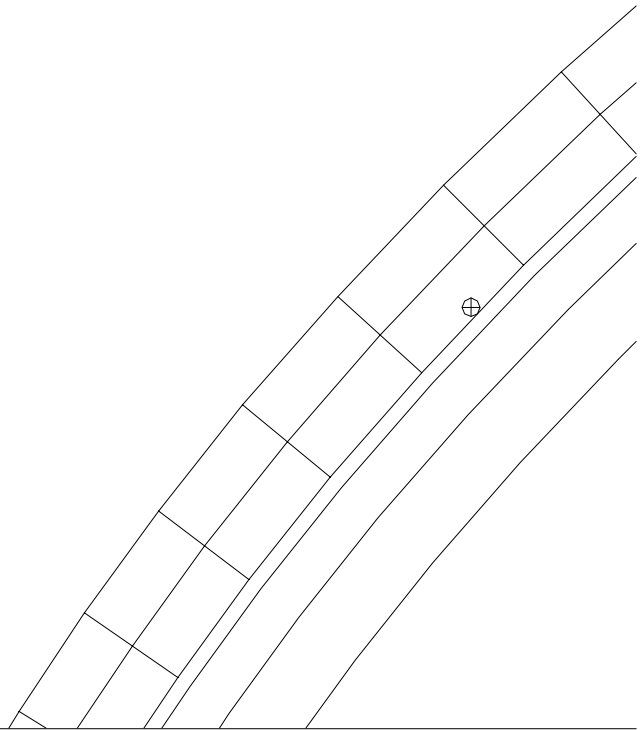

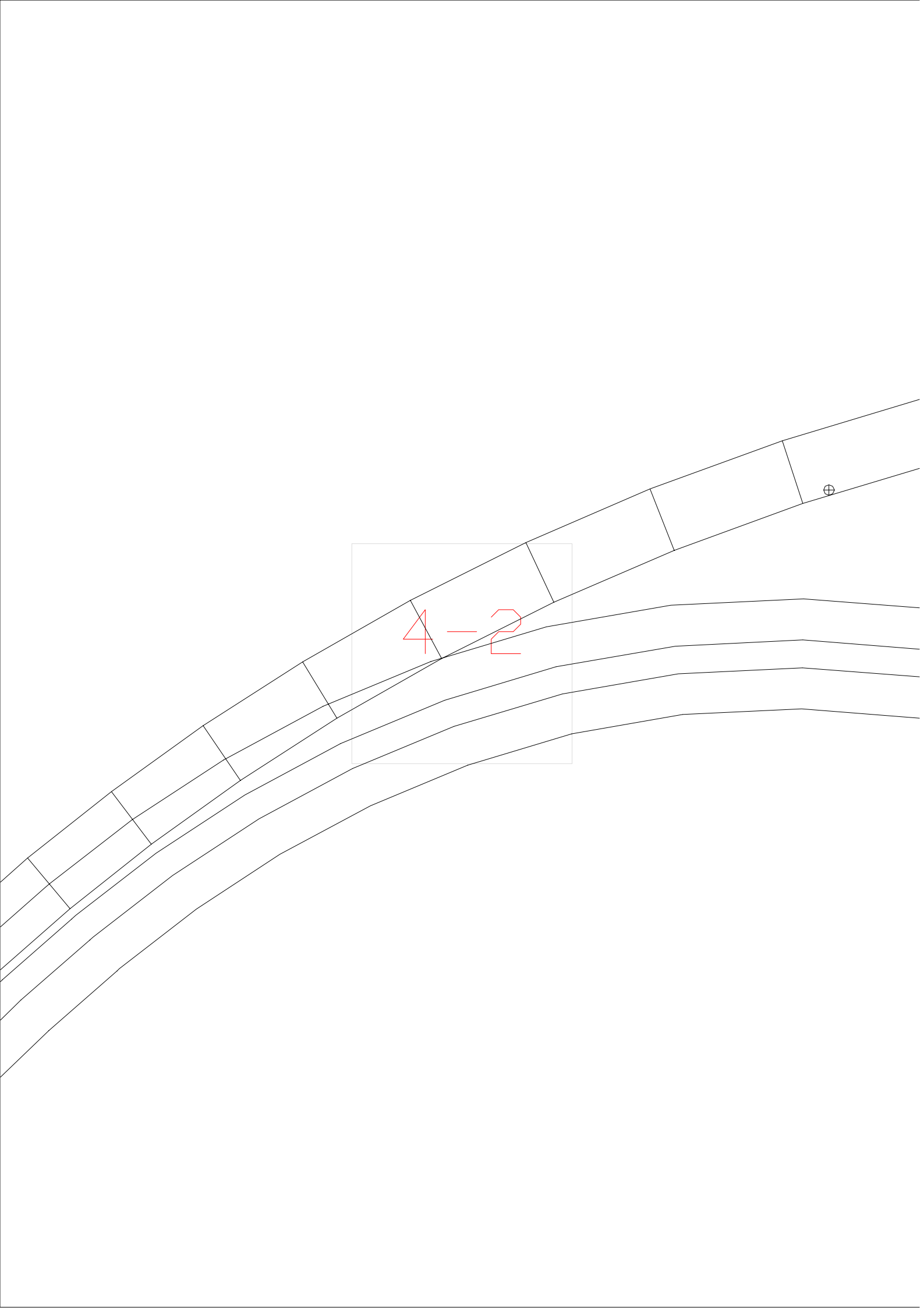

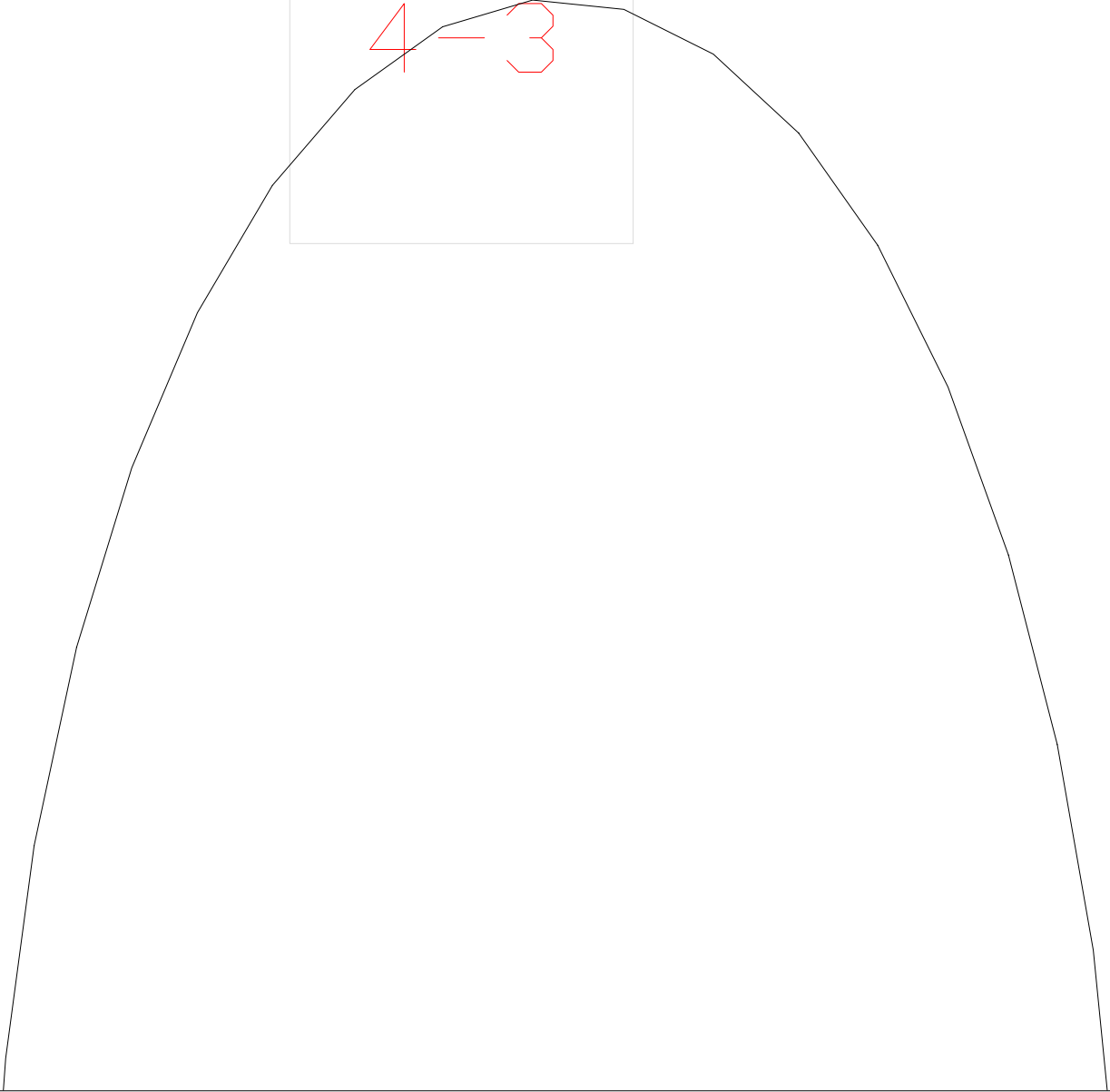
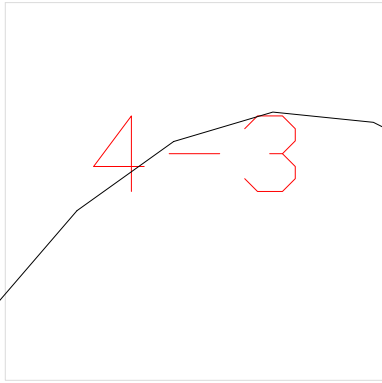
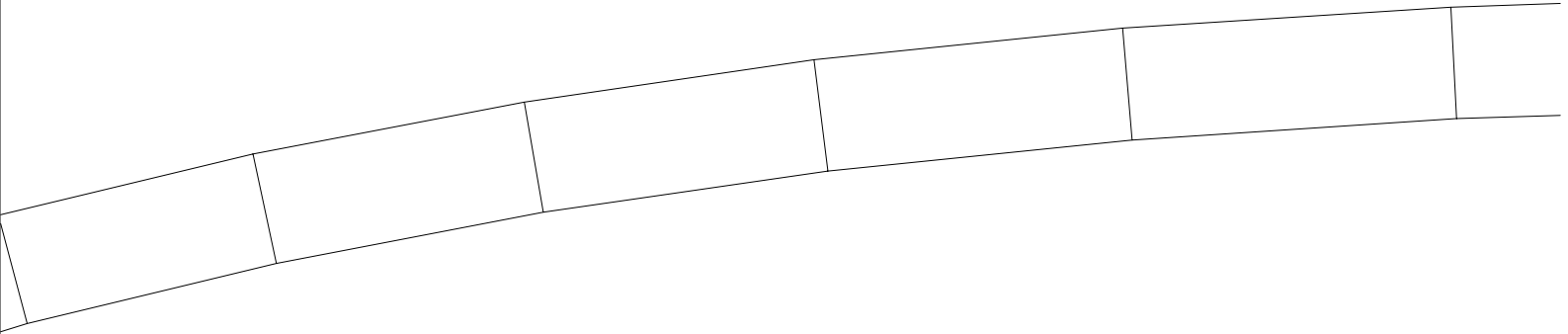



$$4 - 4$$

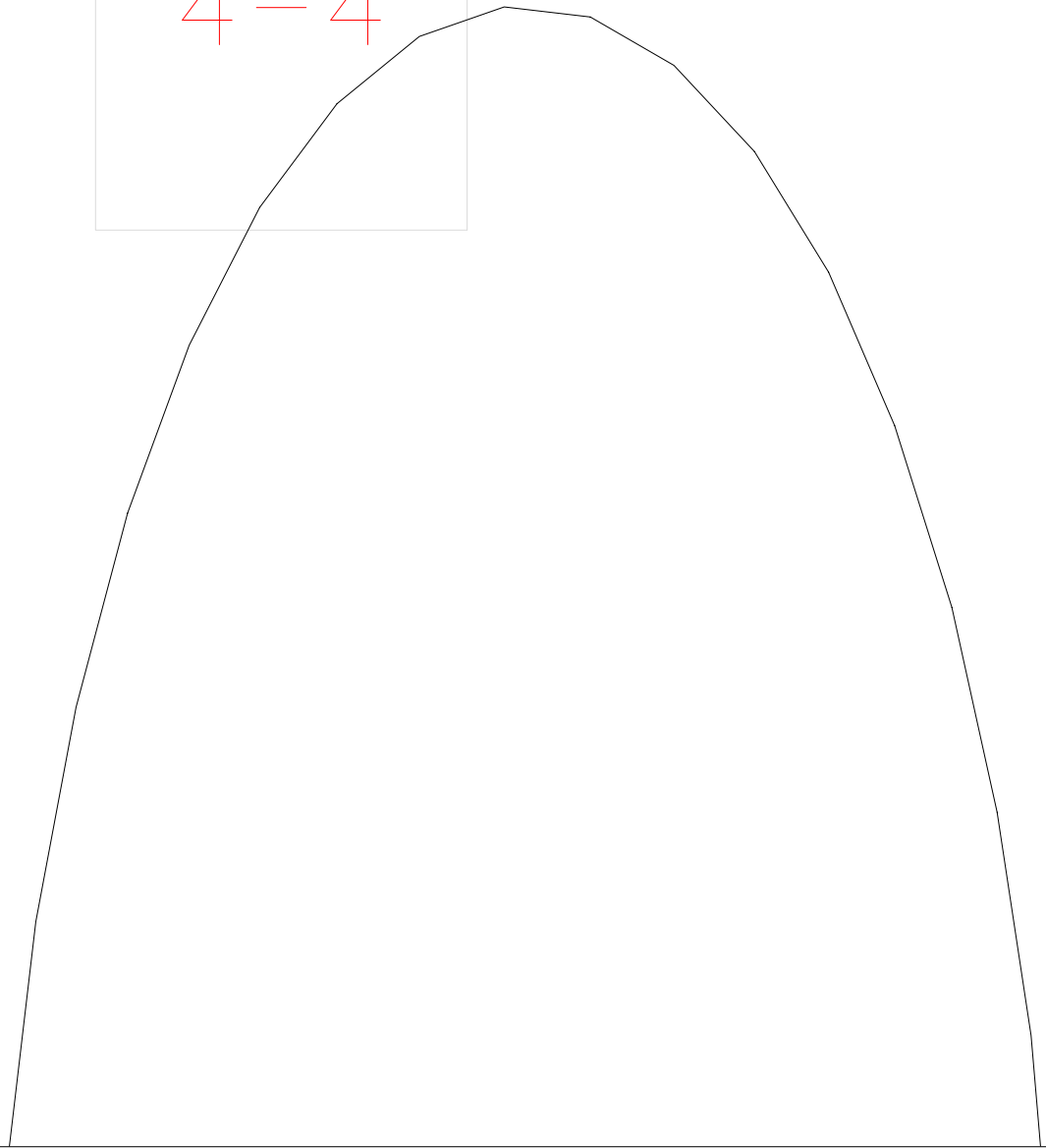

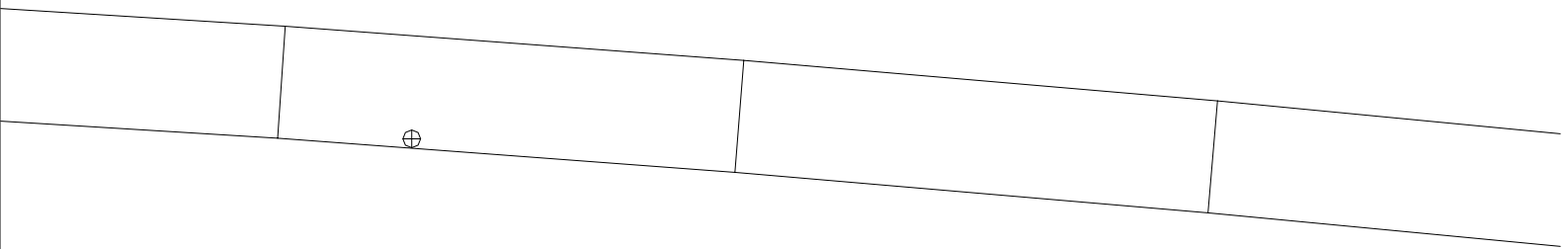

4-5

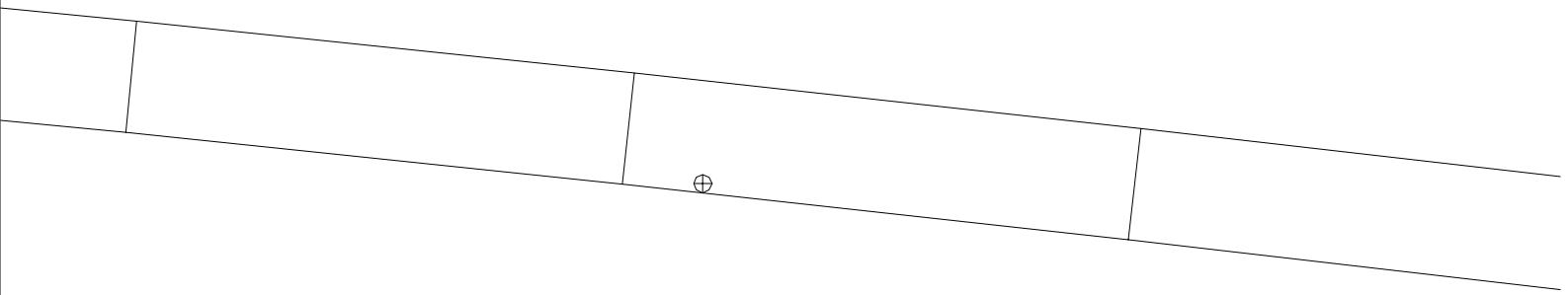

4-6

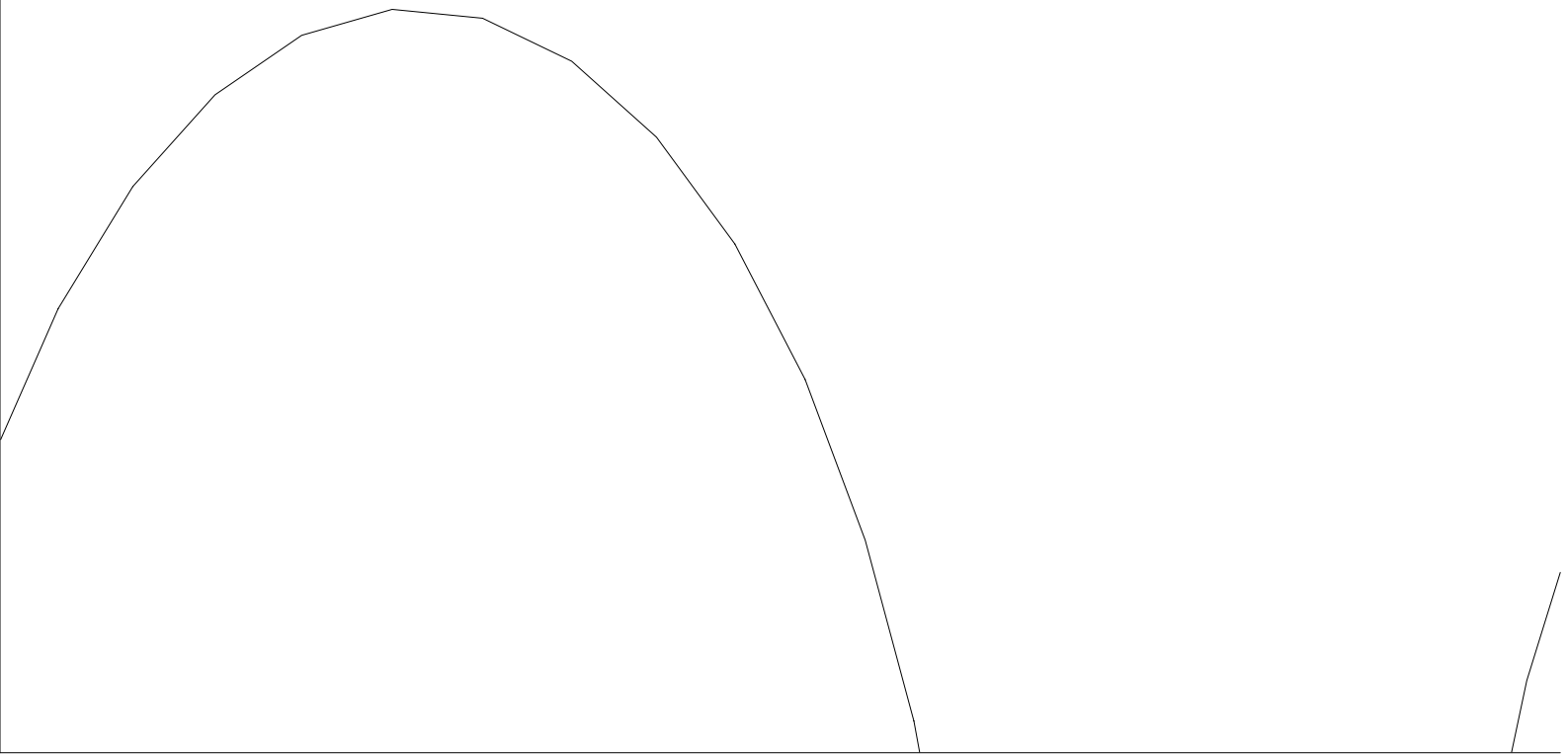

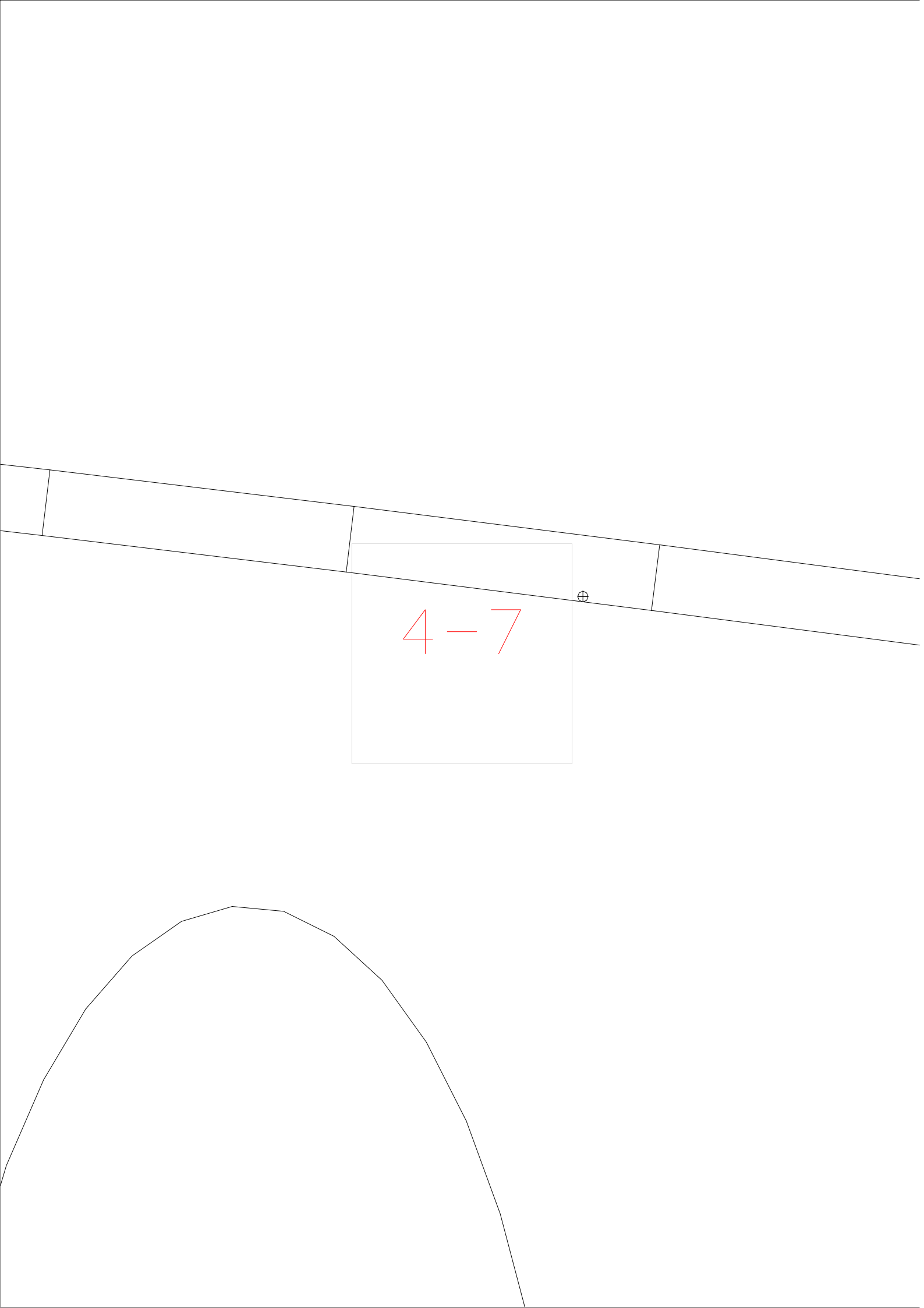

4-7



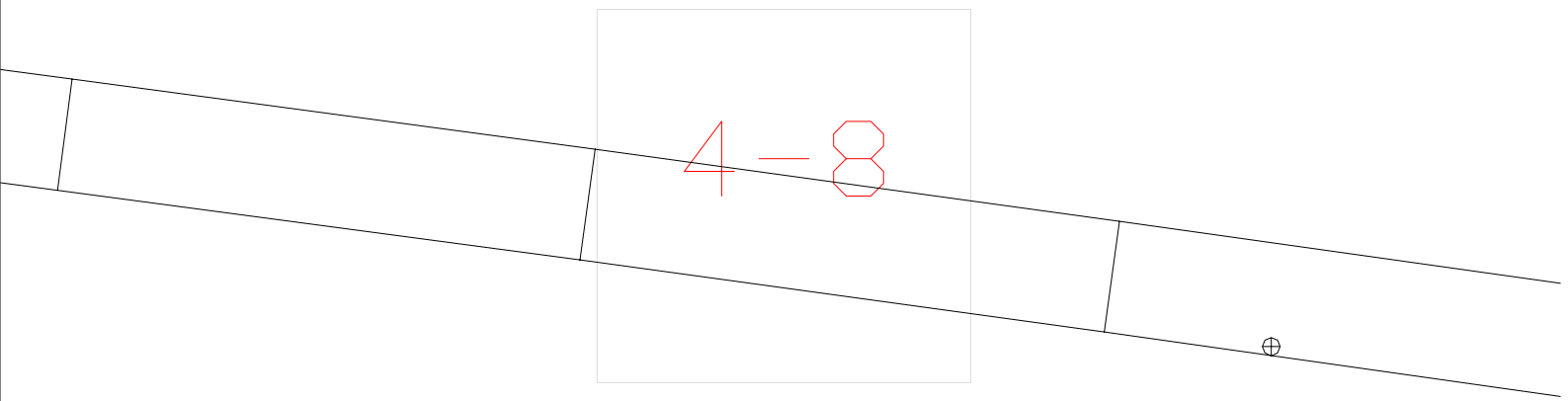

4-8

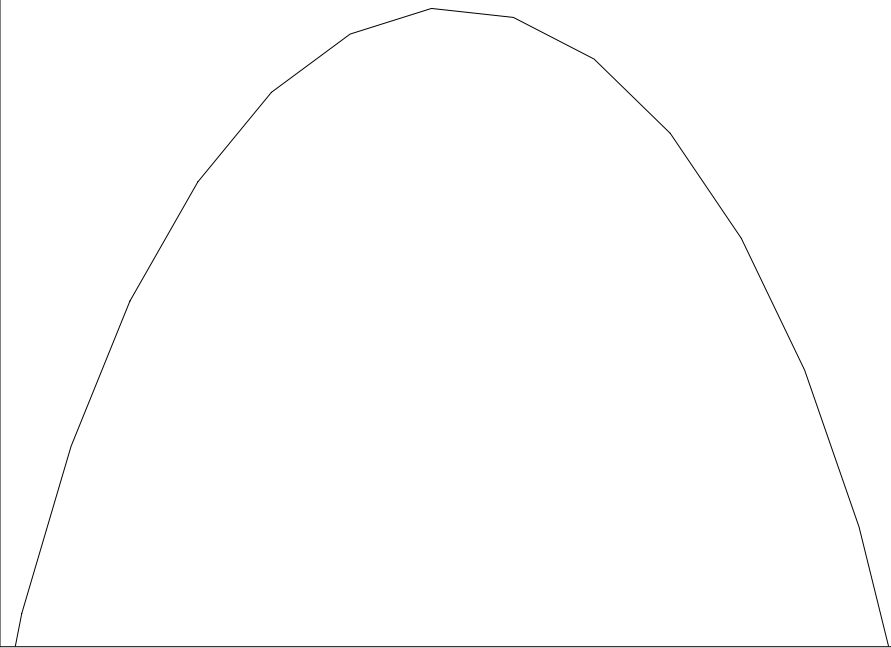

4-9

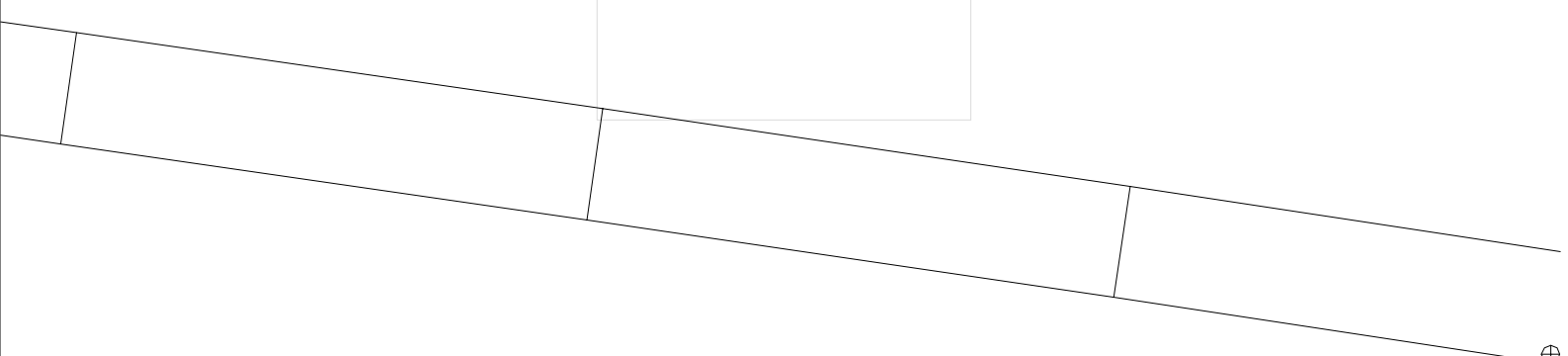

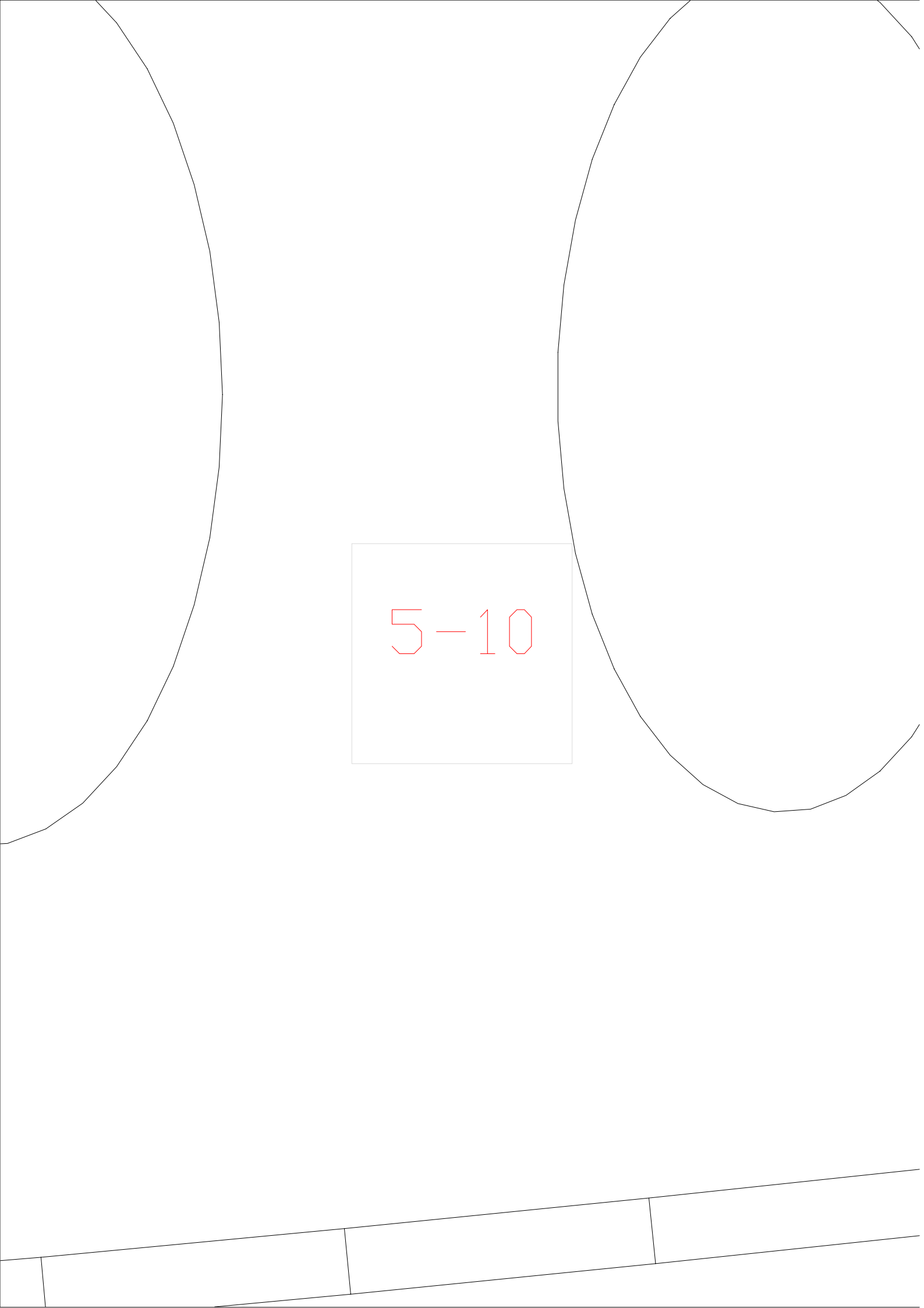

5-10

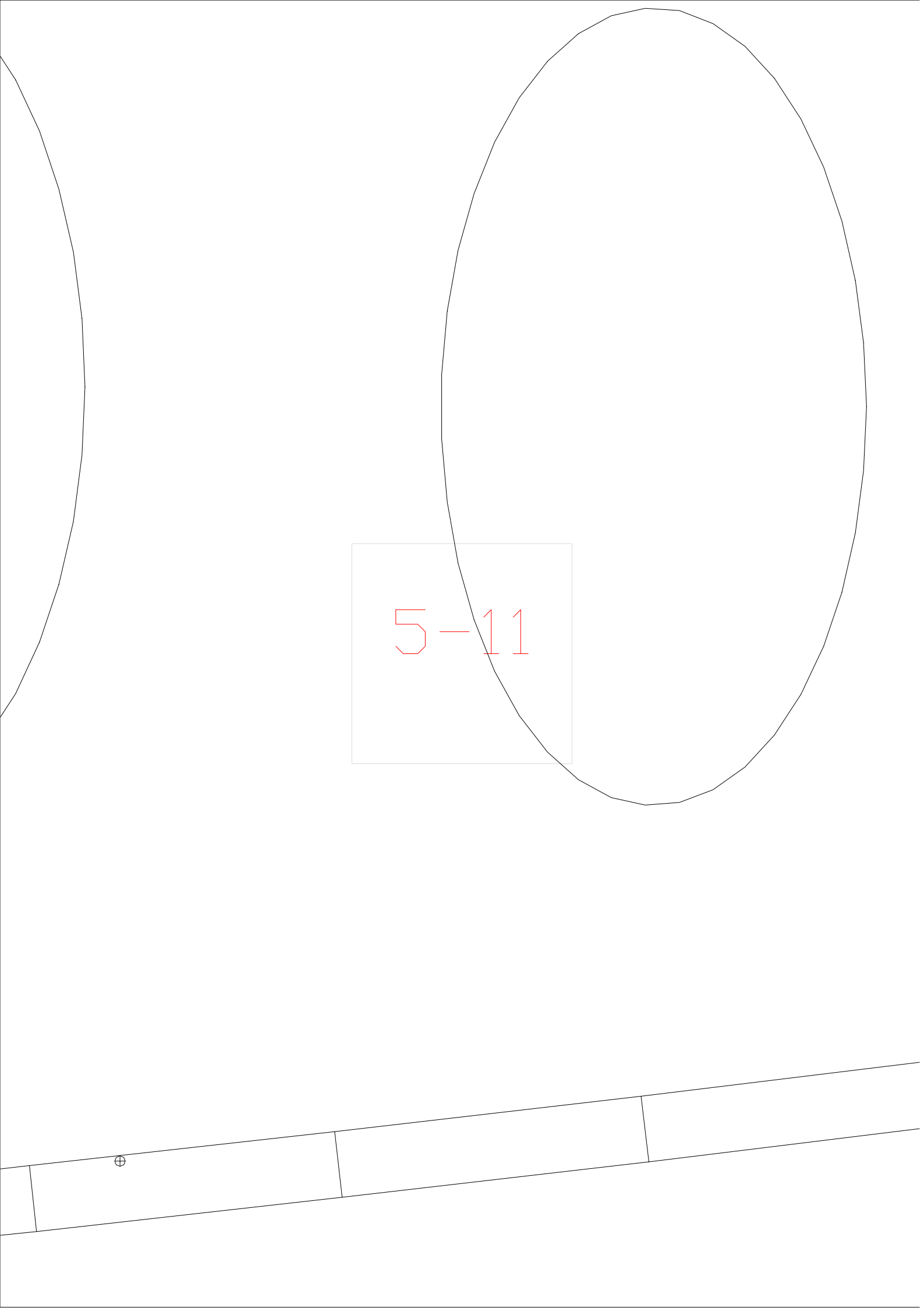

5-11

⊕

5-12



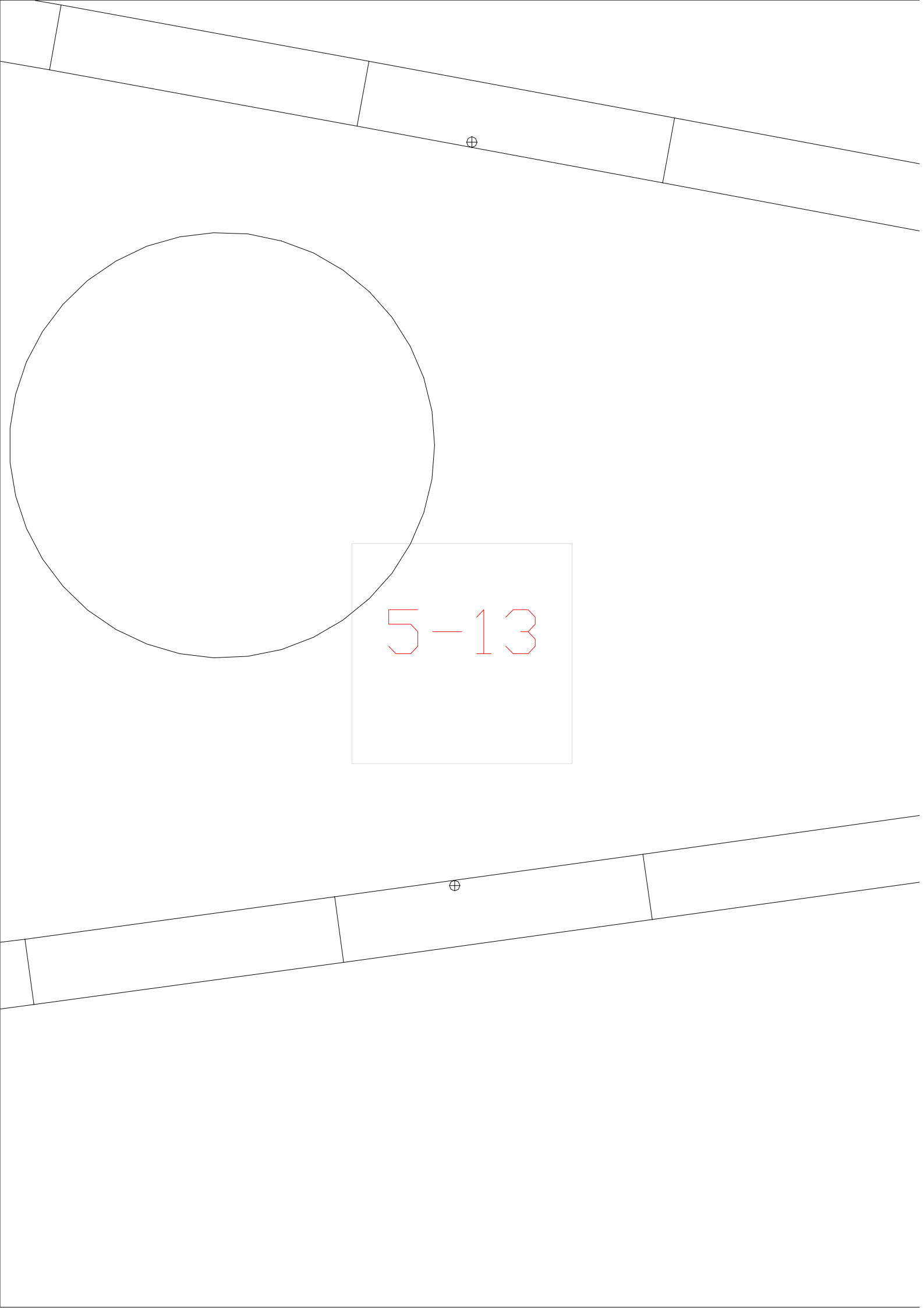

5-13

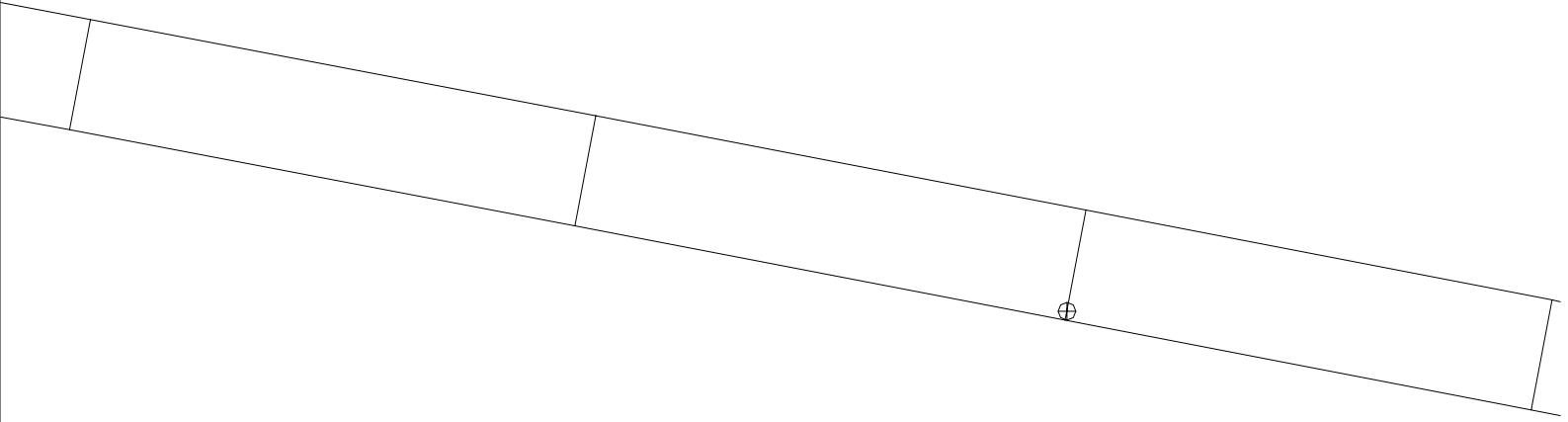

5-14

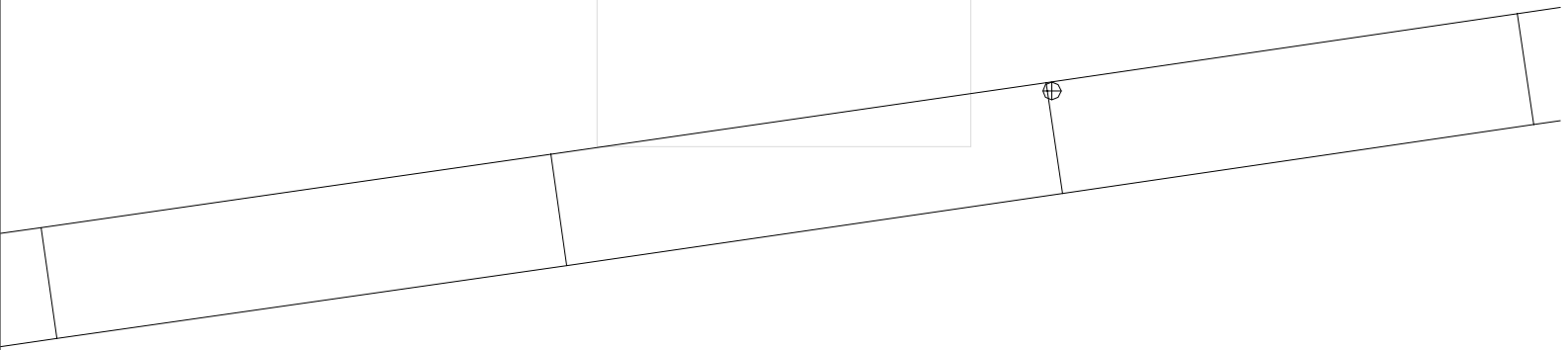

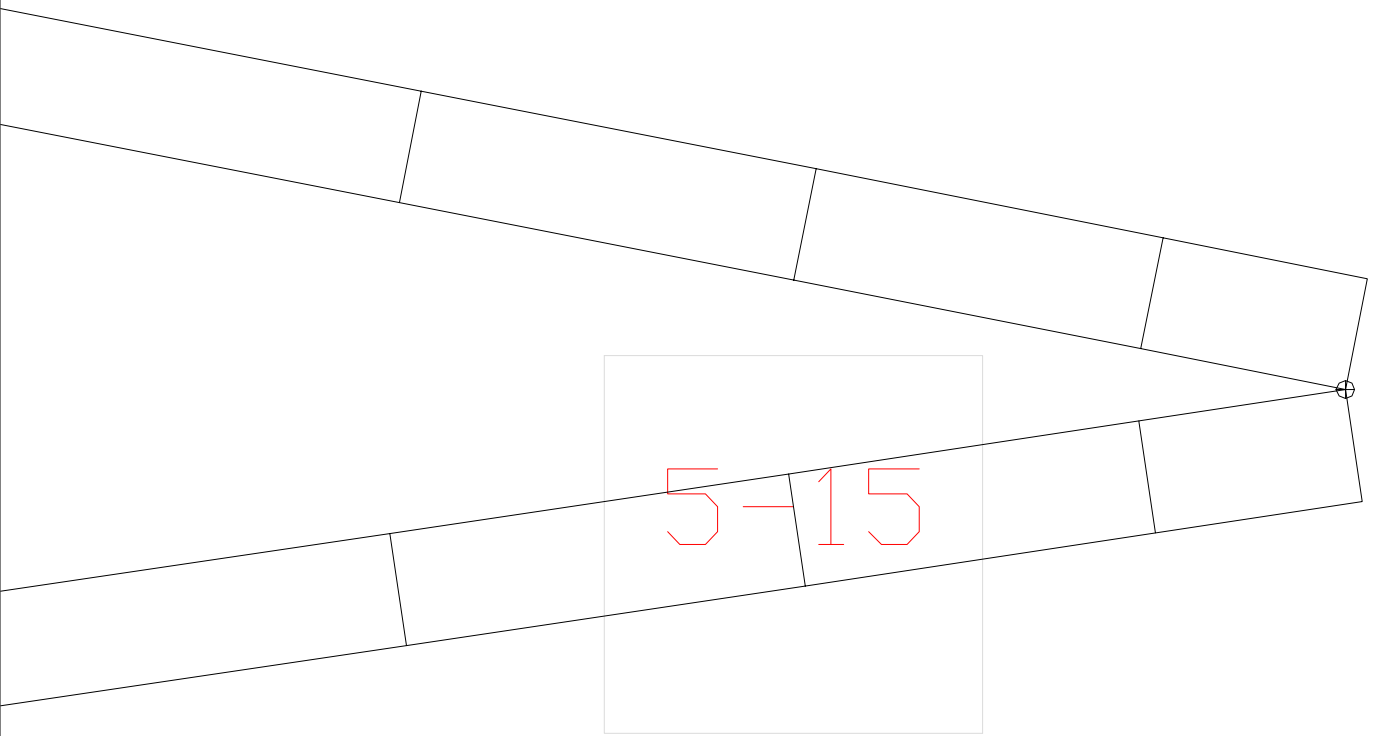

5-15

5-16

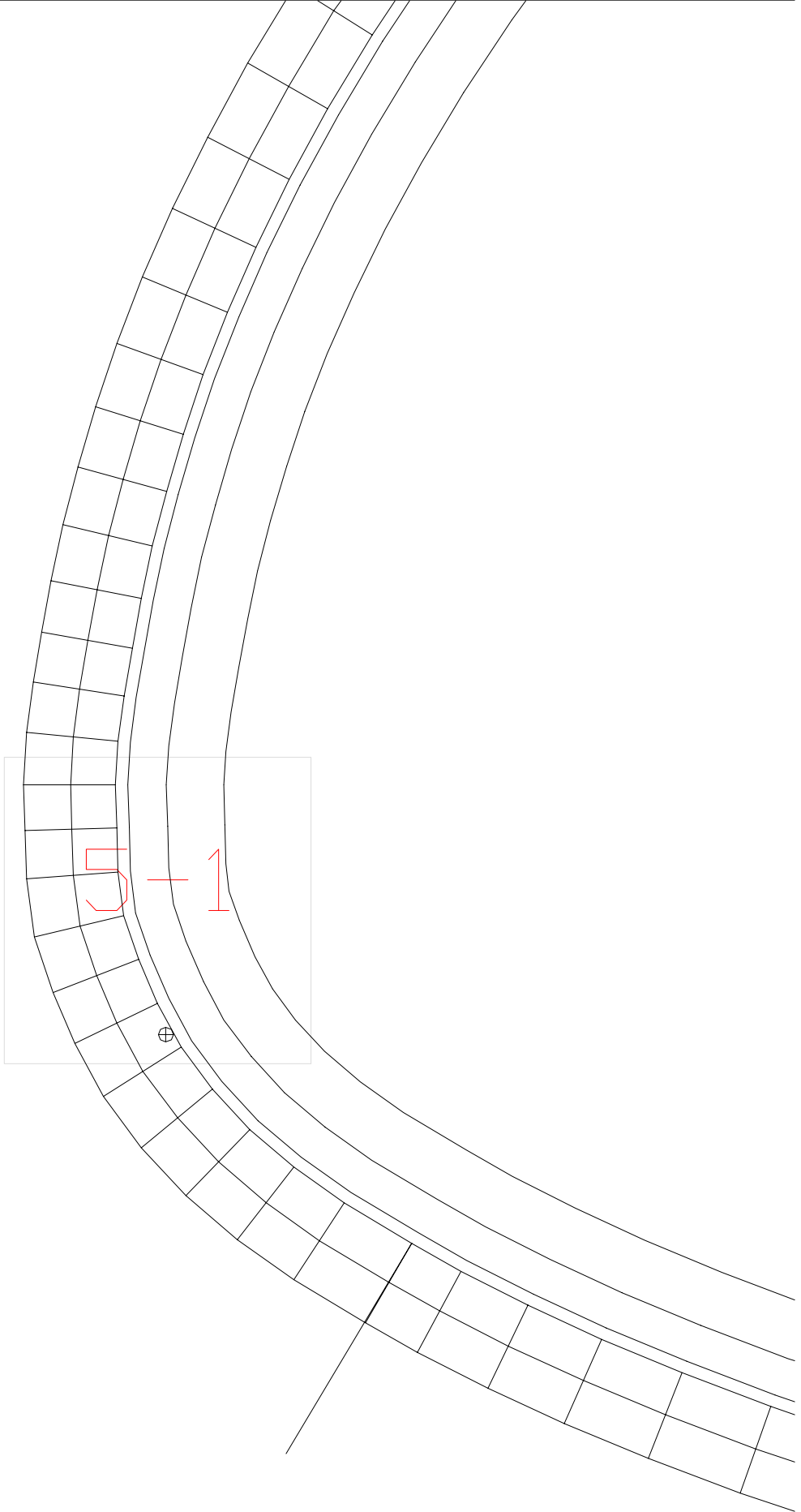

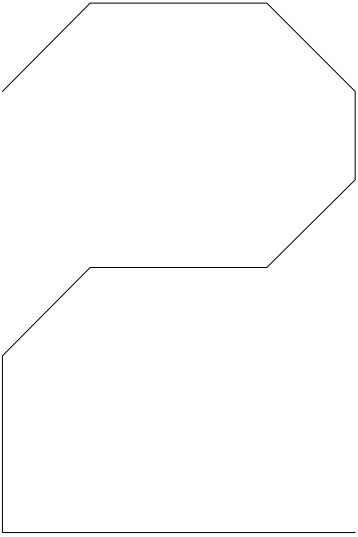

5-2

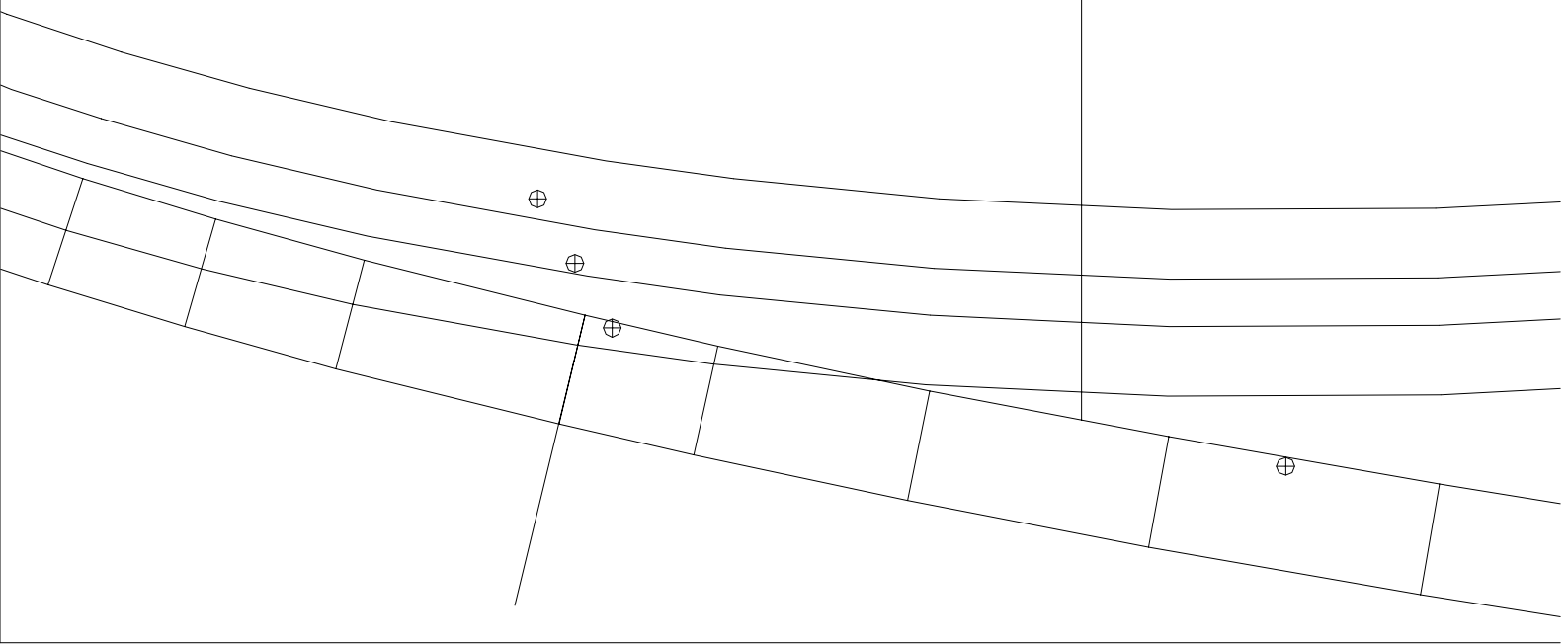

5-3

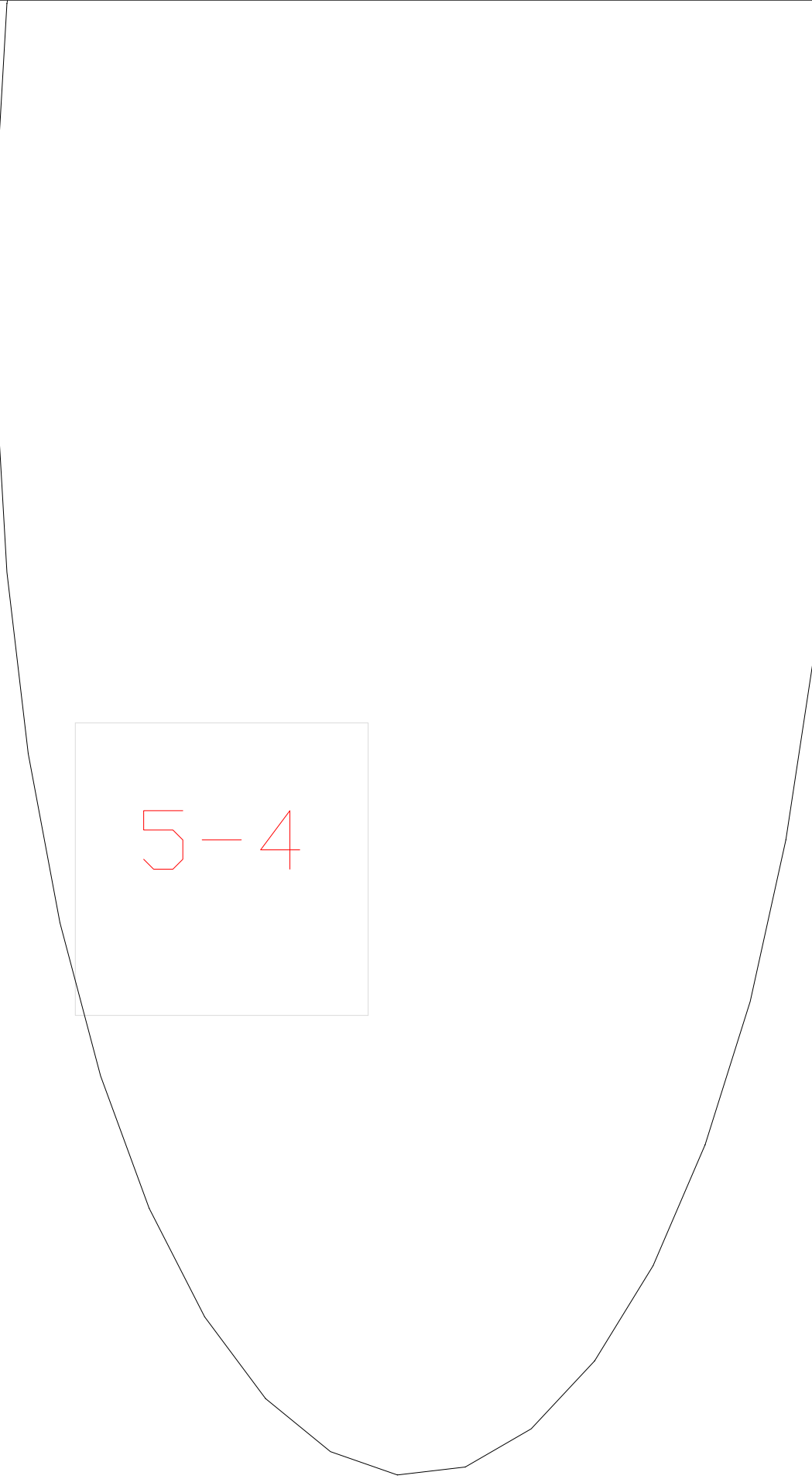

5-4

5-5

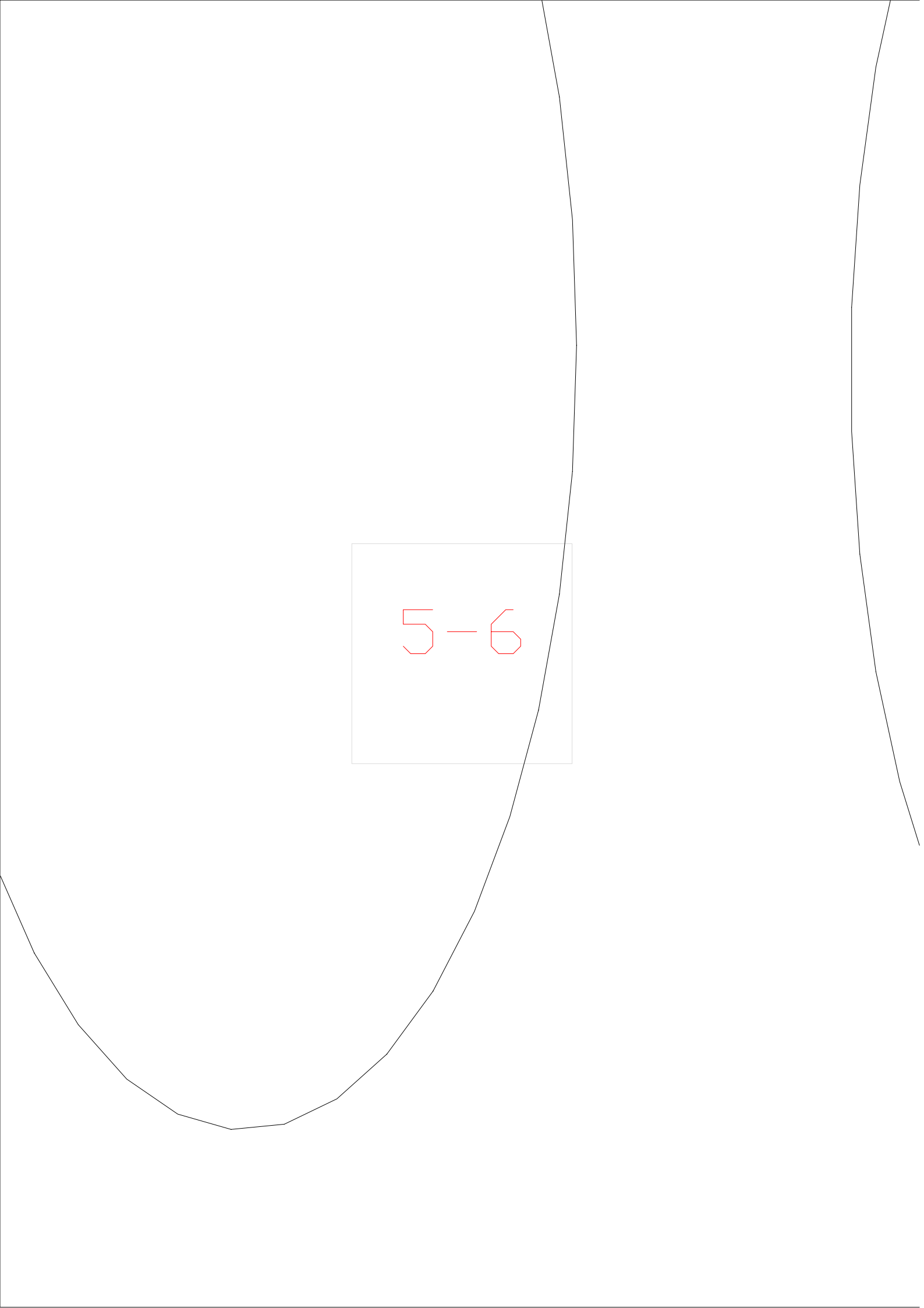

5-6

A hand-drawn diagram on a white background. A large, irregular, U-shaped curve is drawn in black ink, starting from the left edge, dipping down, and rising back up towards the right. In the center of this curve, there is a light gray rectangular box. Inside this box, the text "5-7" is written in red ink. The numbers "5" and "7" are connected by a short horizontal line. The "5" has a small hook at the bottom, and the "7" has a diagonal stroke at the end. The overall appearance is that of a sketch or a diagram, possibly representing a range or a specific point in a sequence.

5-7



5-8

5-9

6-10

6-11

6-12

6-13

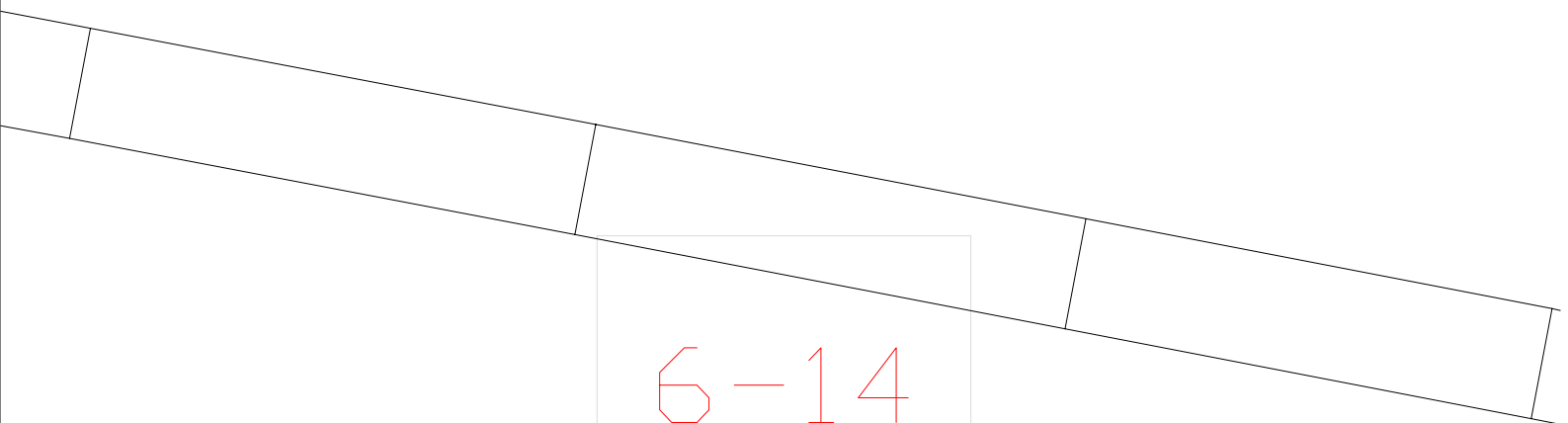

6-14

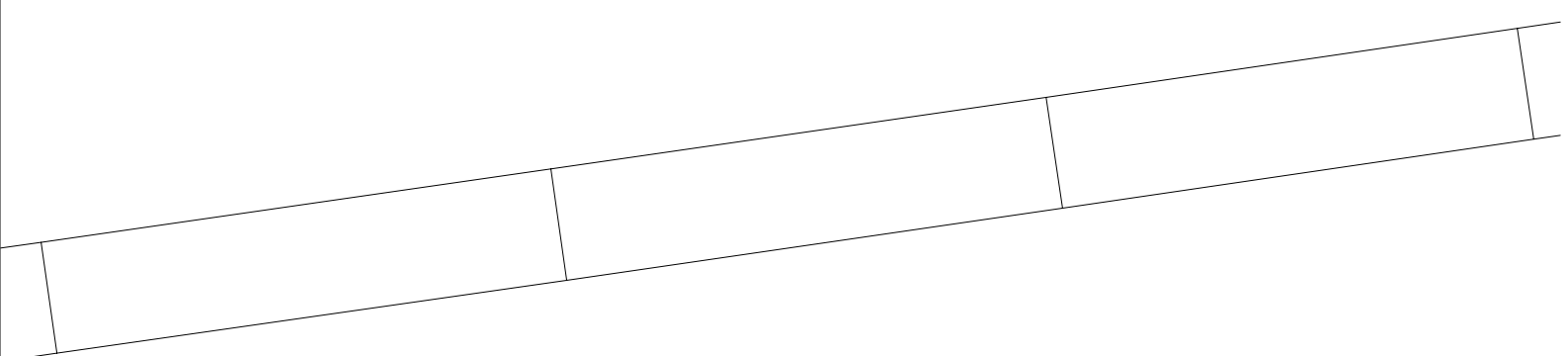

6-14

6-15

3

6-16

6-2

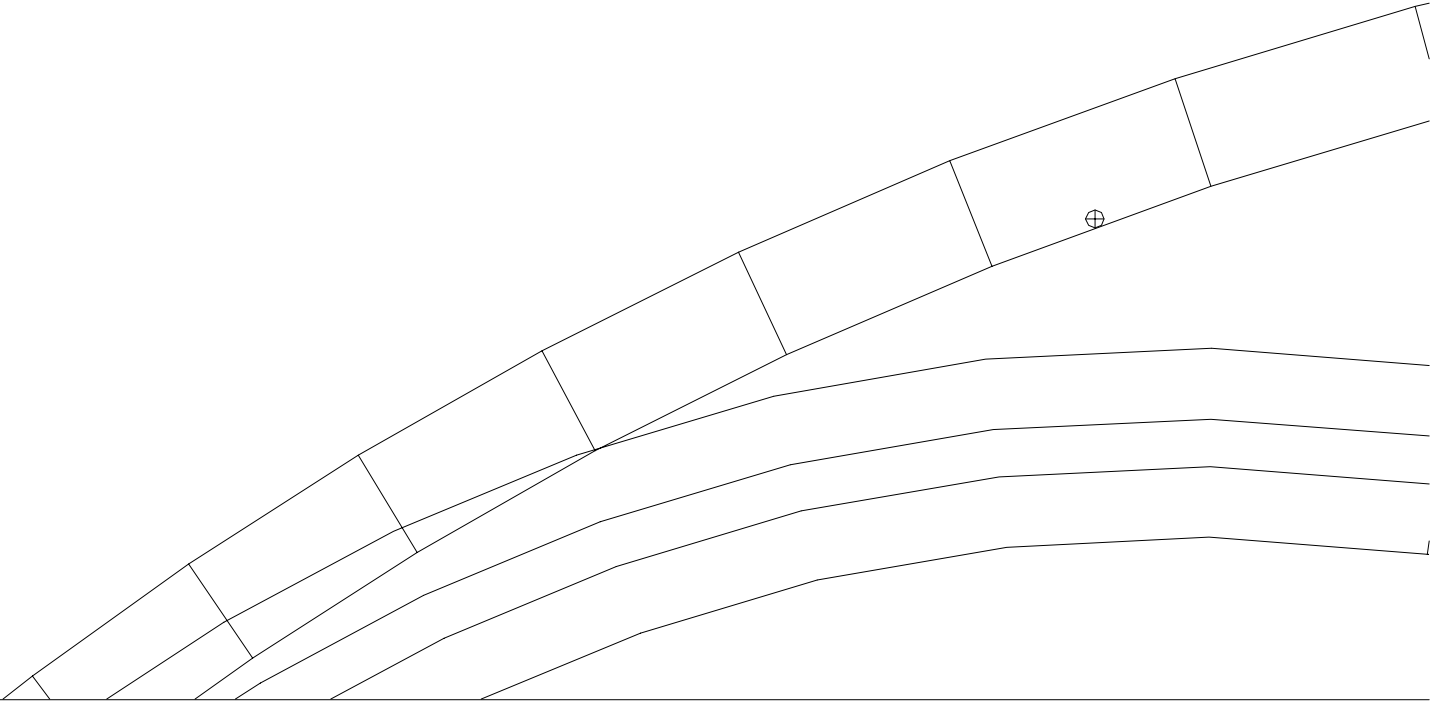



6-3

The image shows a technical drawing of a curved structure, possibly a pipe or duct, with a central label '6-3'. The structure is divided into several segments by vertical lines. The drawing is oriented vertically, with the curved part at the top and bottom. The label '6-3' is centered within a rectangular box in the middle of the drawing. The drawing is a line drawing with no shading or color.

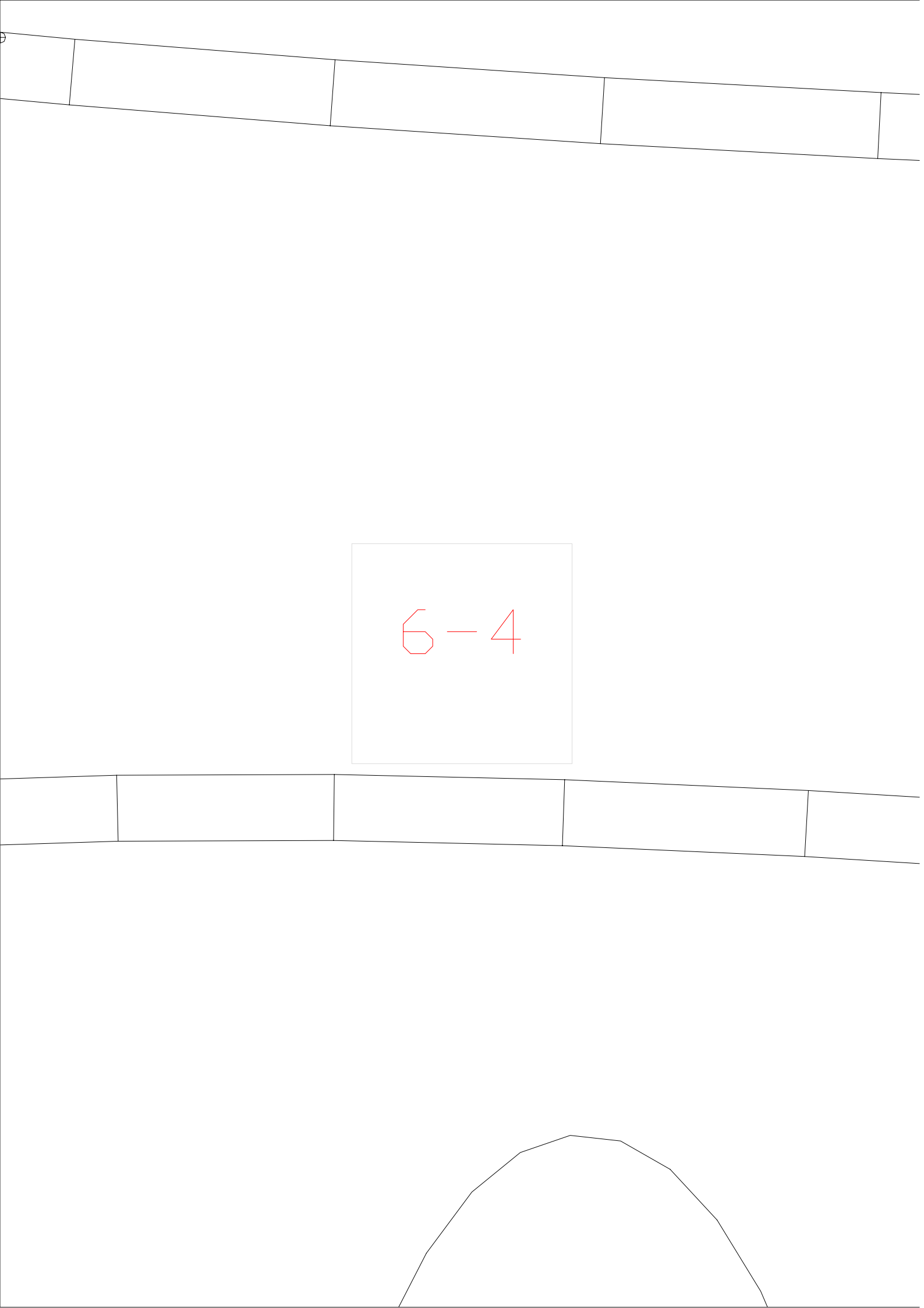

6-4

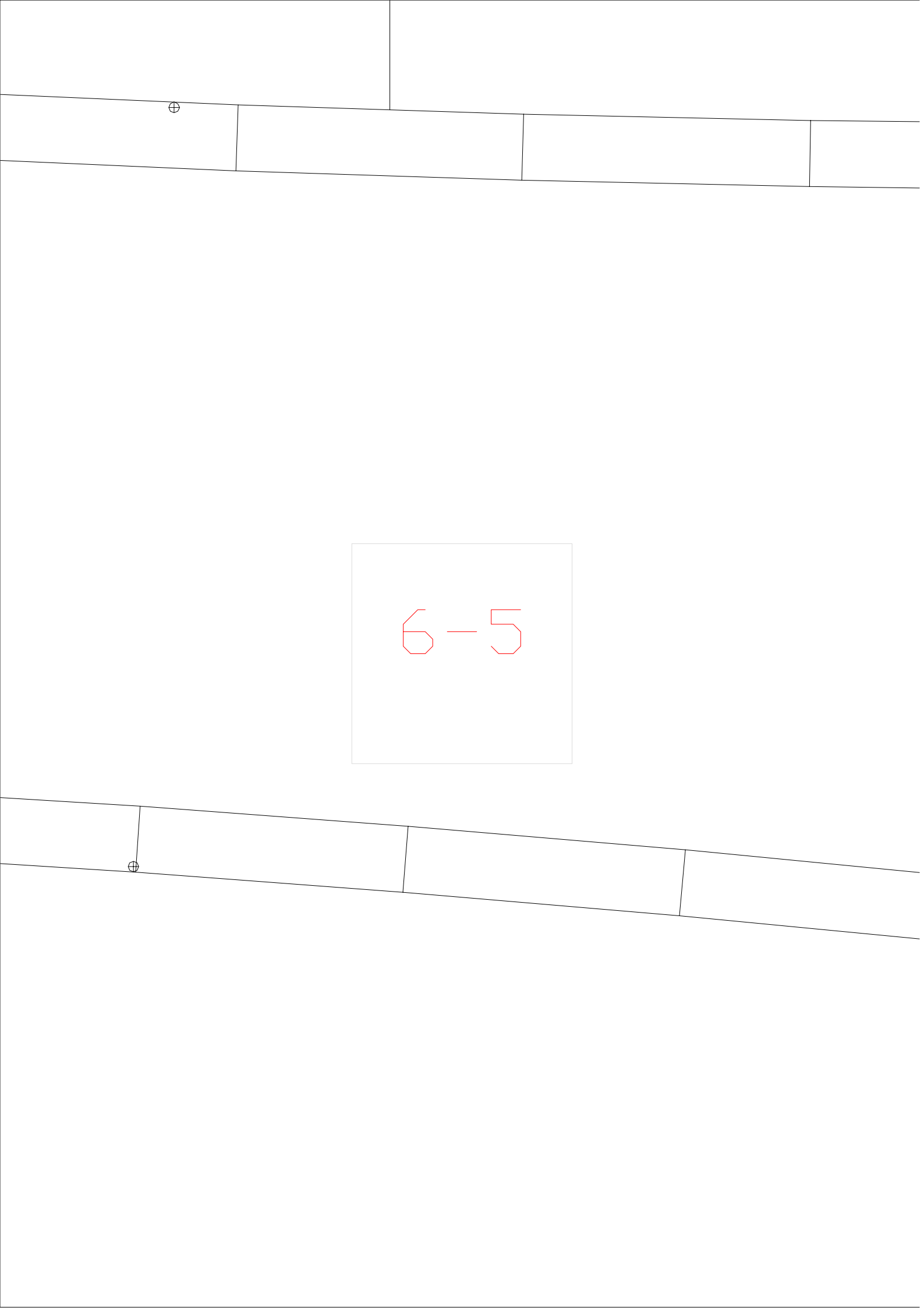

	⊕		
--	---	--	--

6-6

		⊕		
--	--	---	--	--

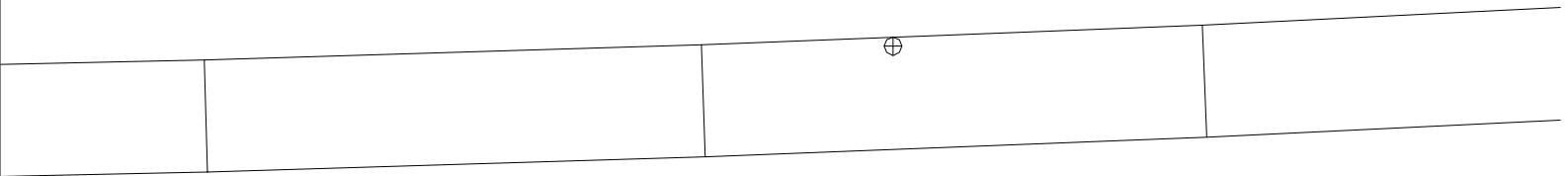

6-7

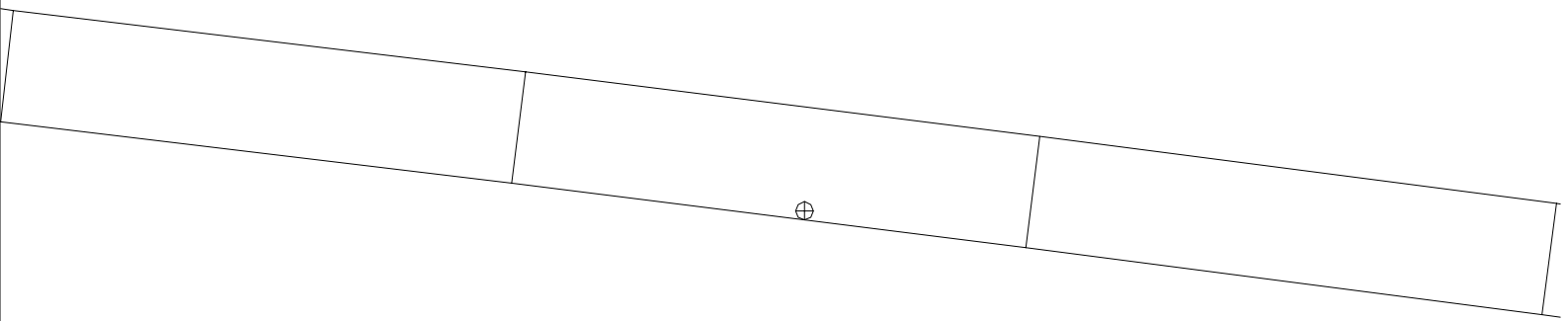

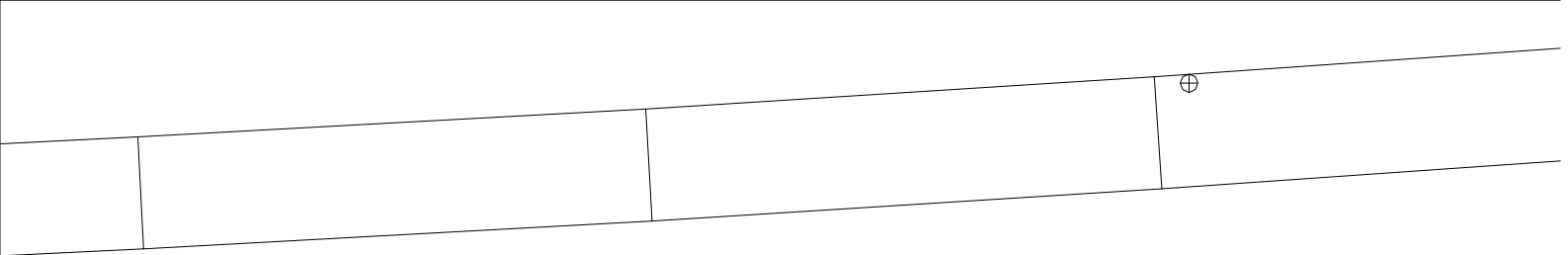

6-8

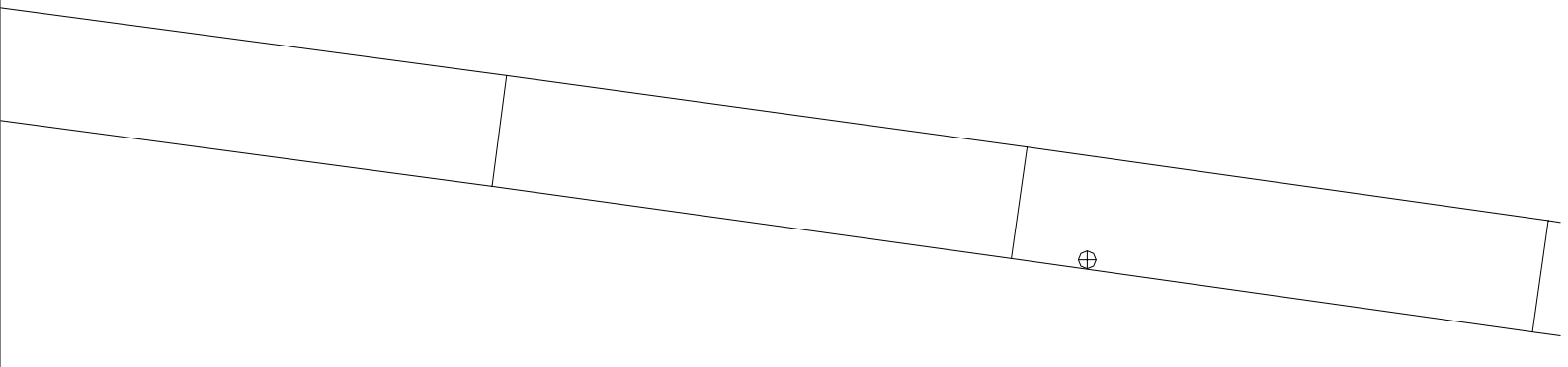

6-9

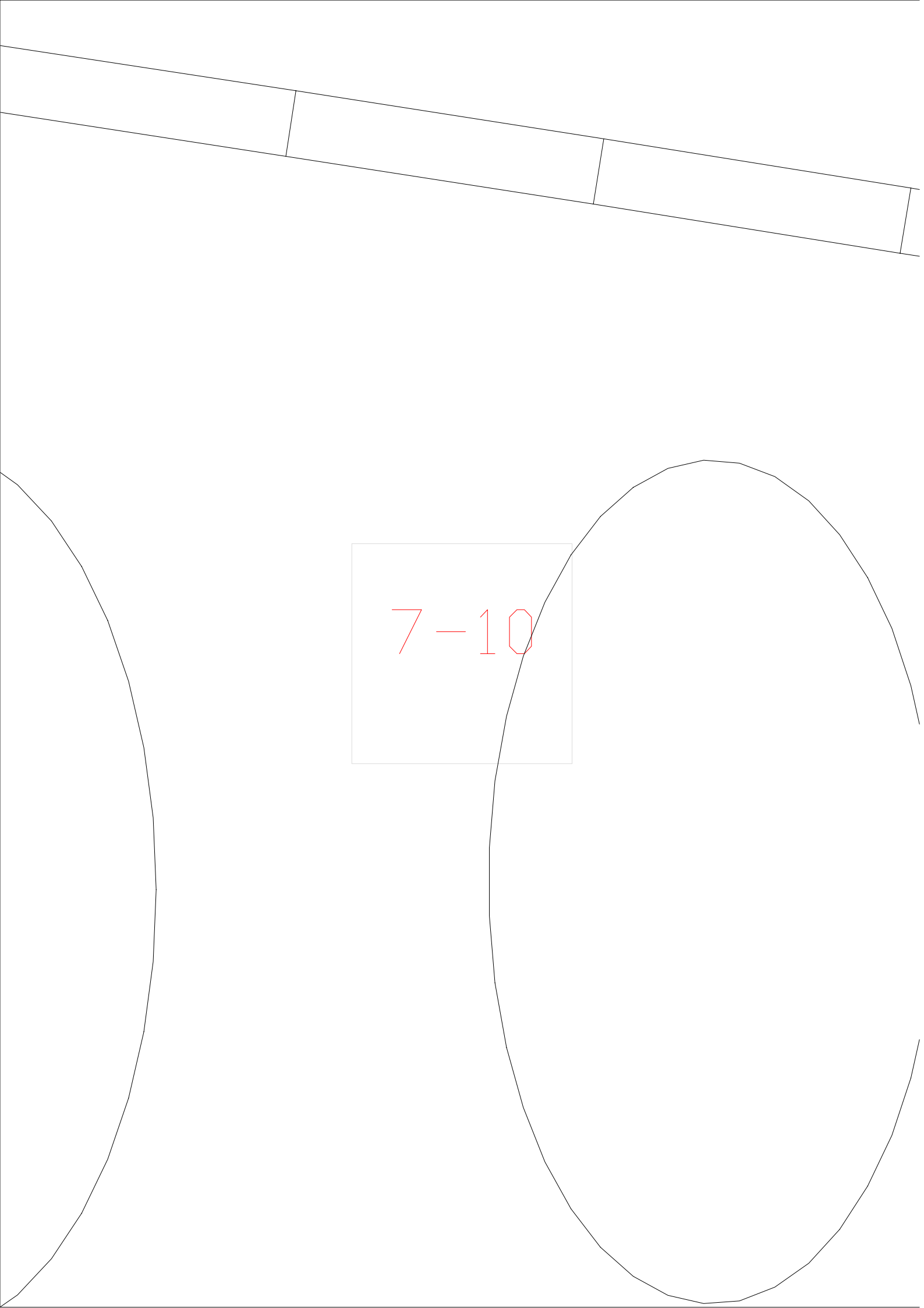

7-10

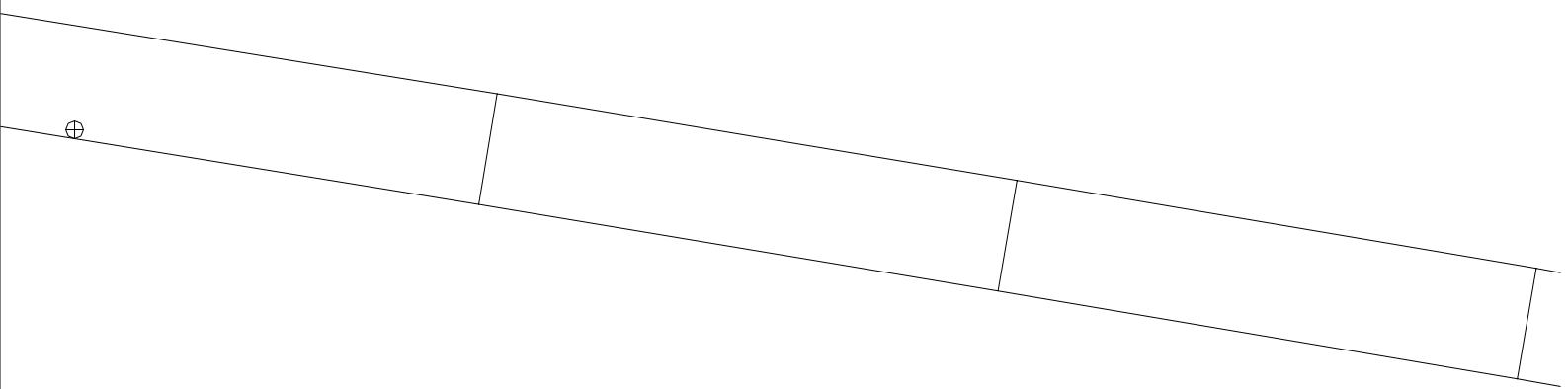

7-11

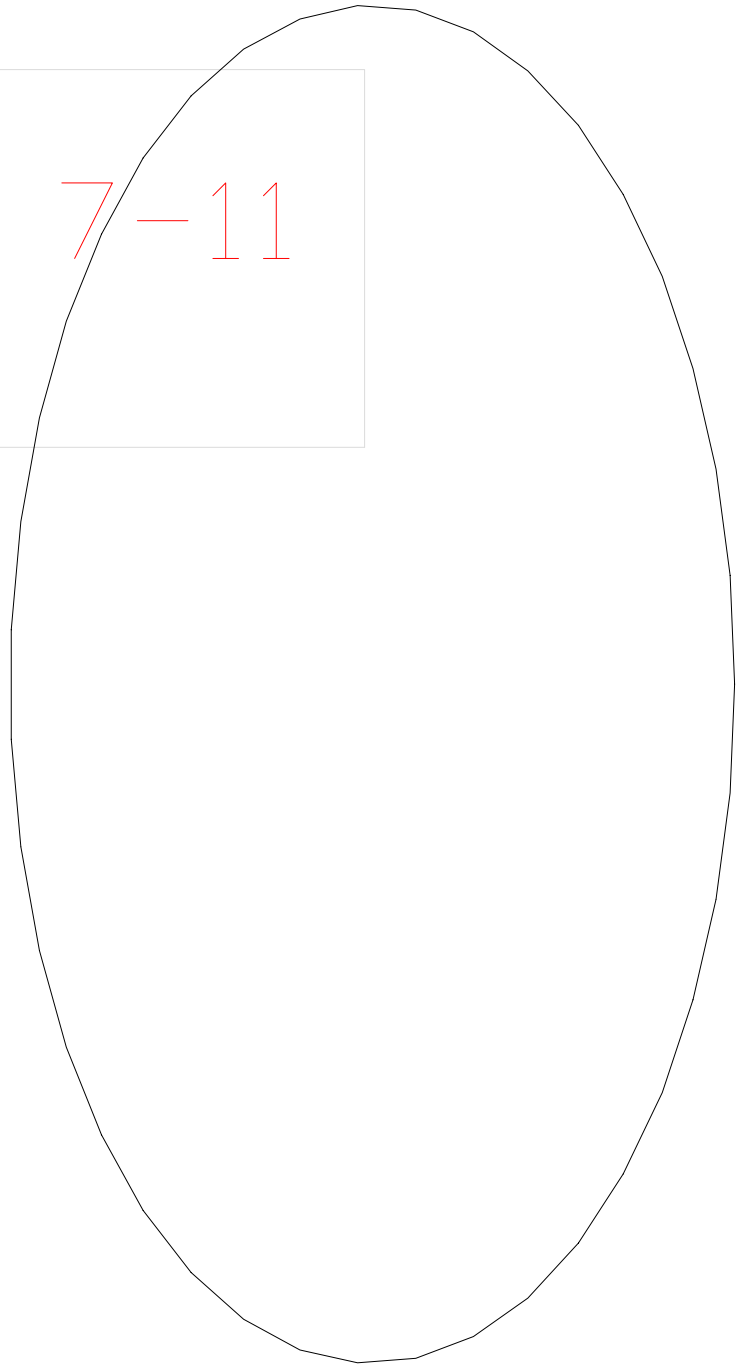



7-12

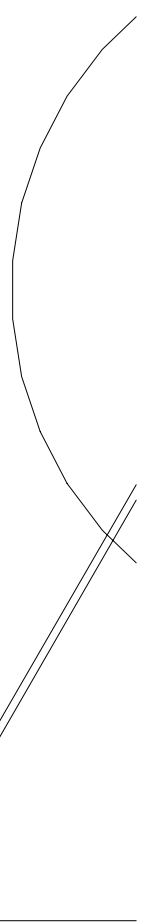

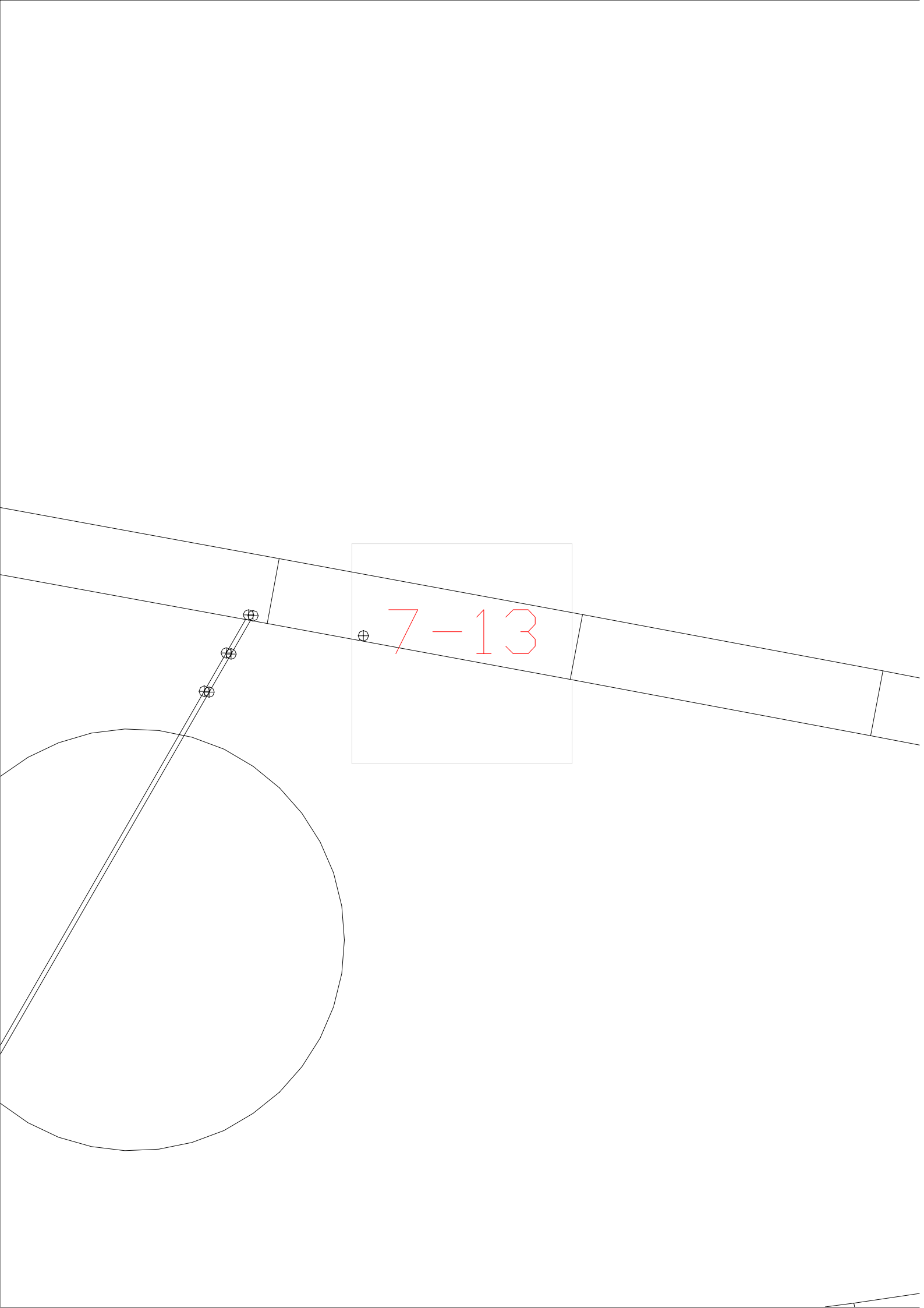

7-13

7-14

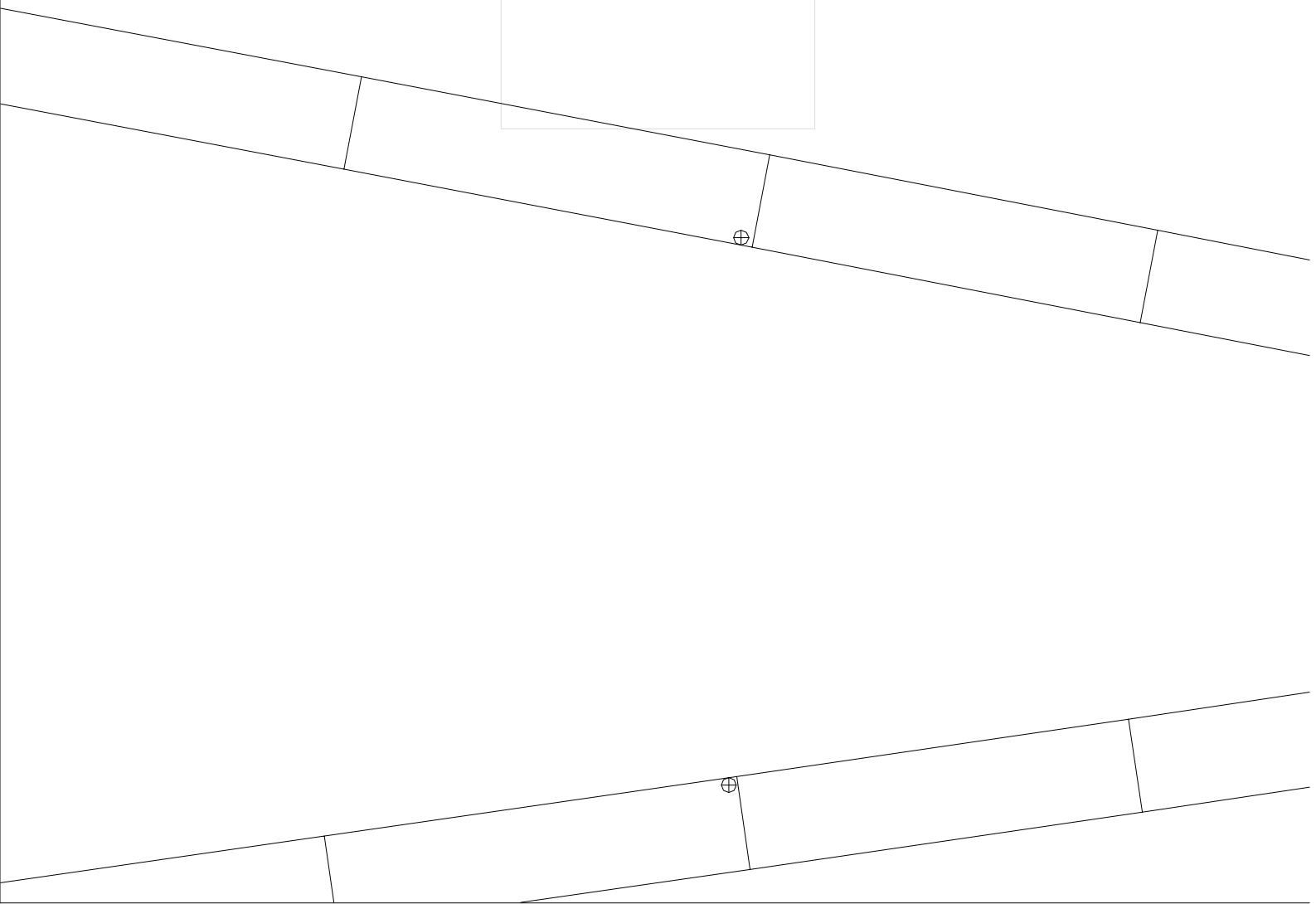

7-15

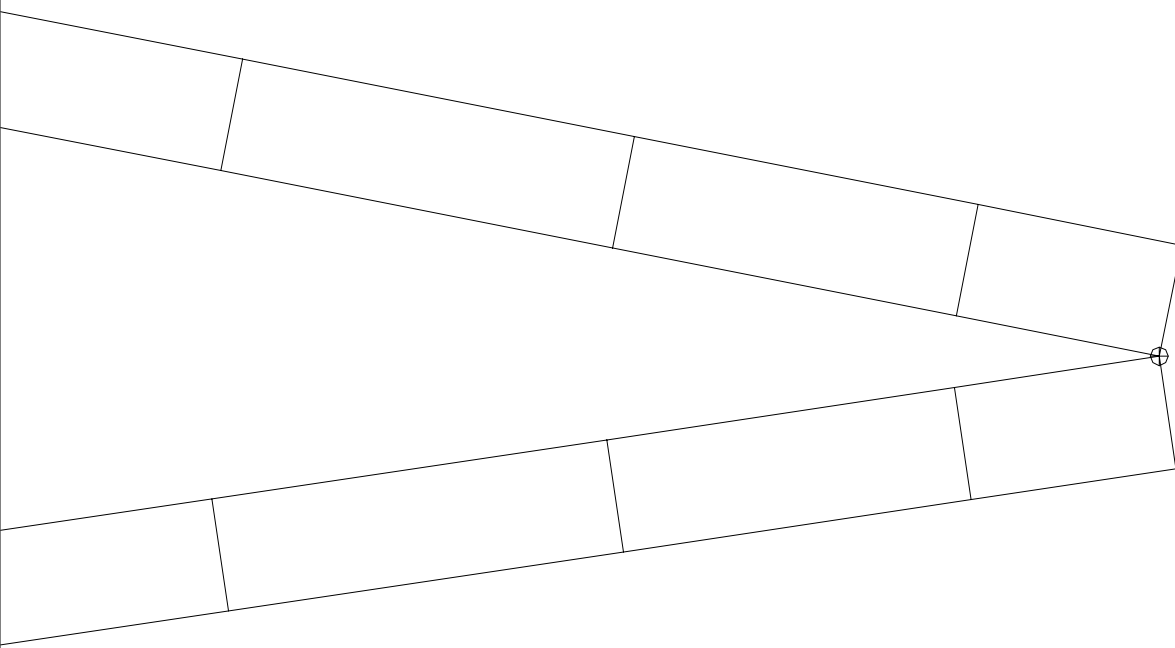

7-16

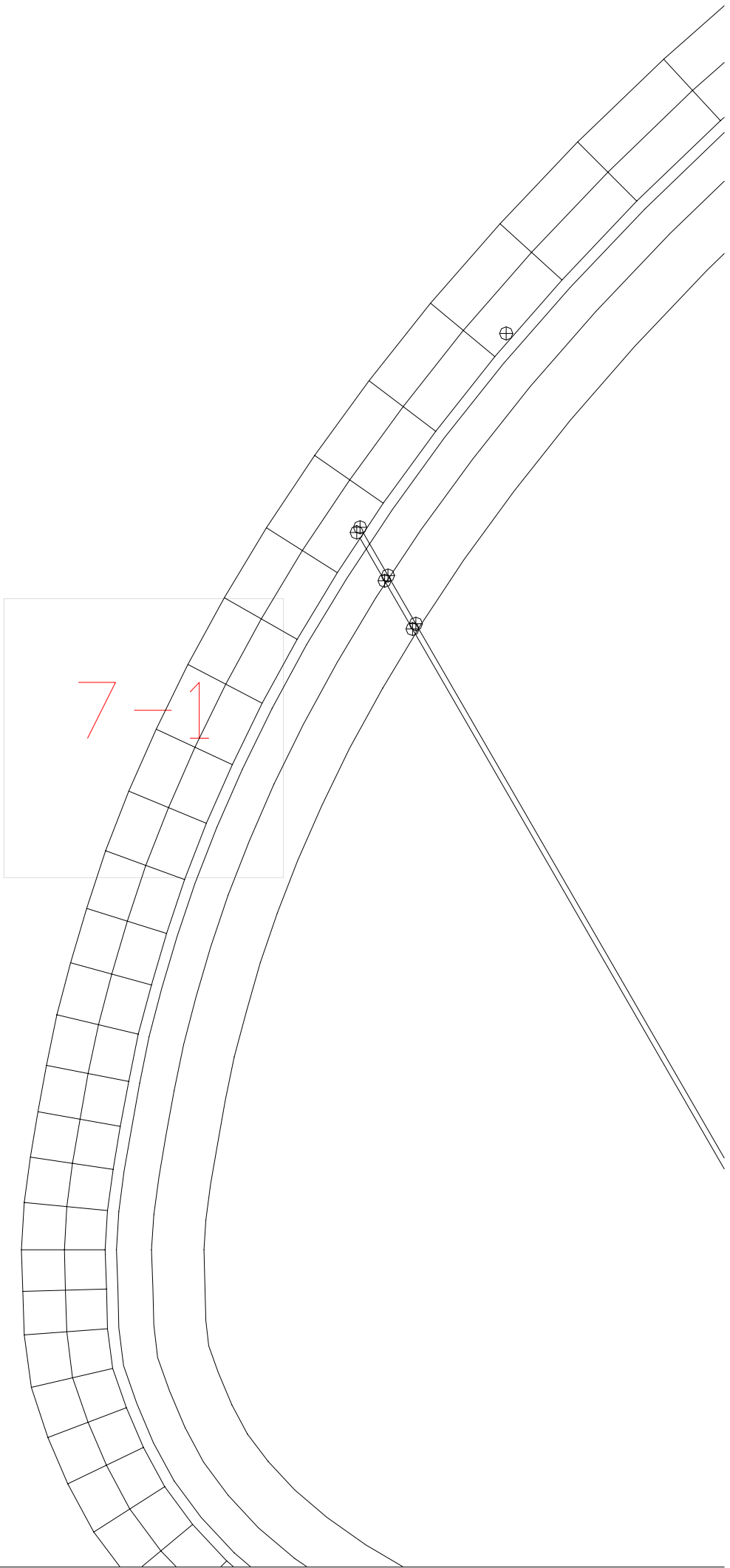

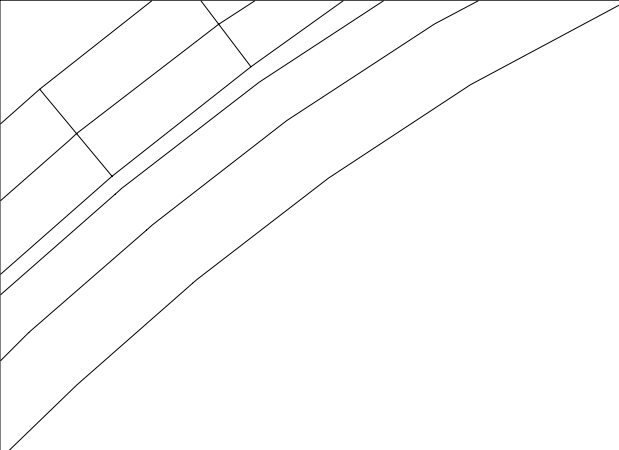

7-2

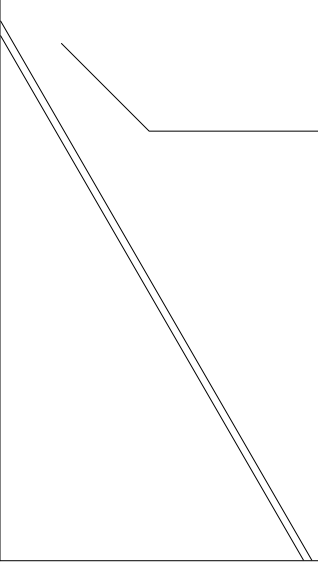
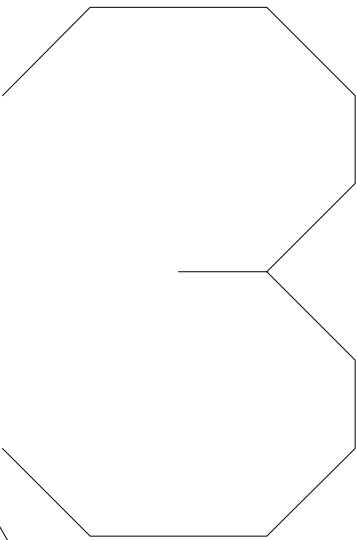



$$7-3$$

$$7 - 4$$

7-5

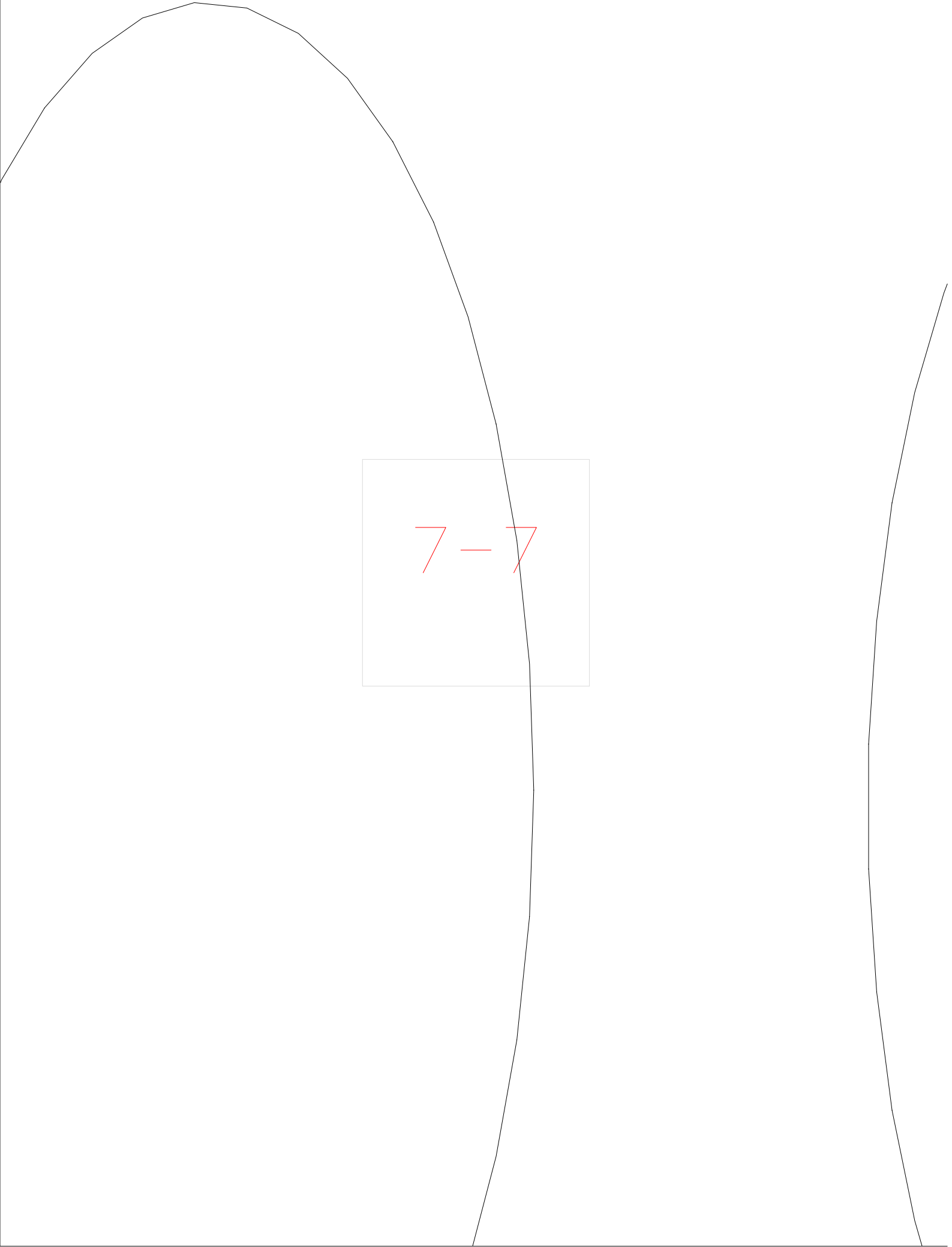

7-6



7-7

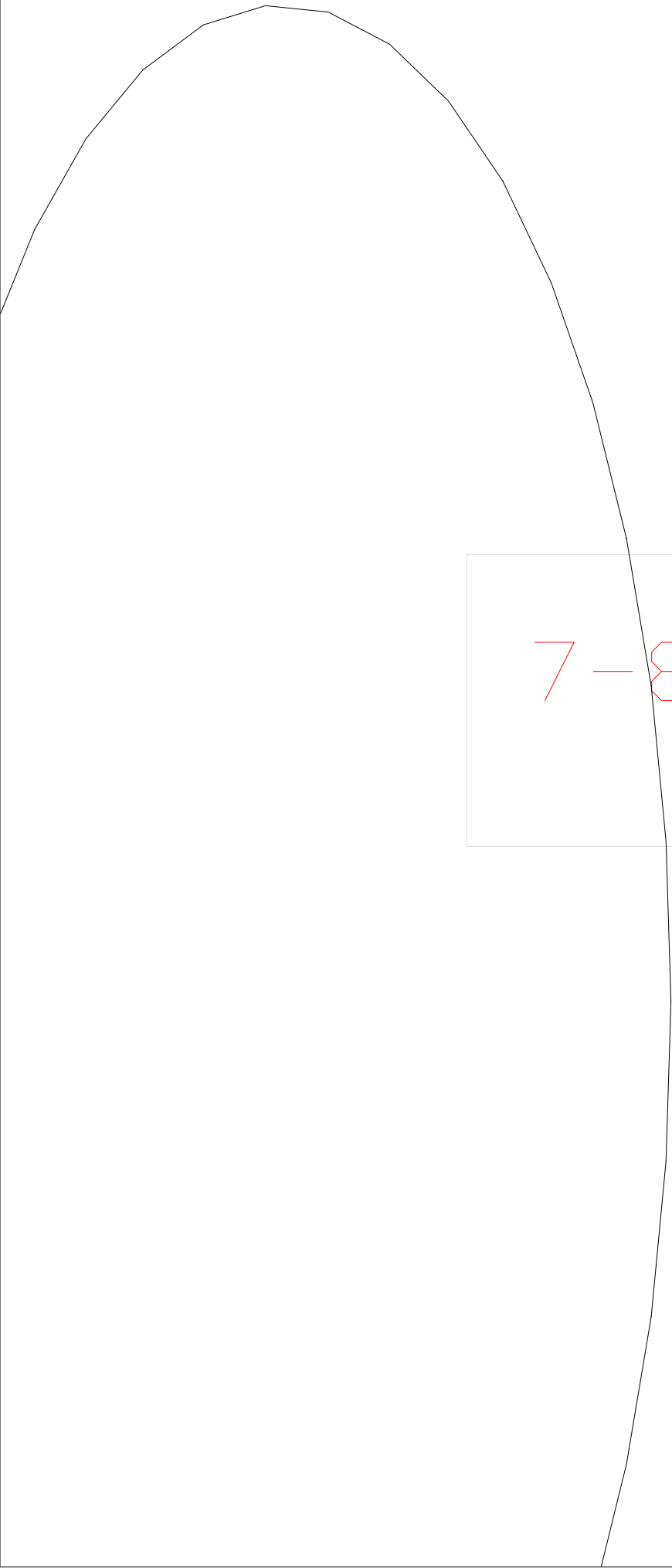

7-8

⊕

7-9

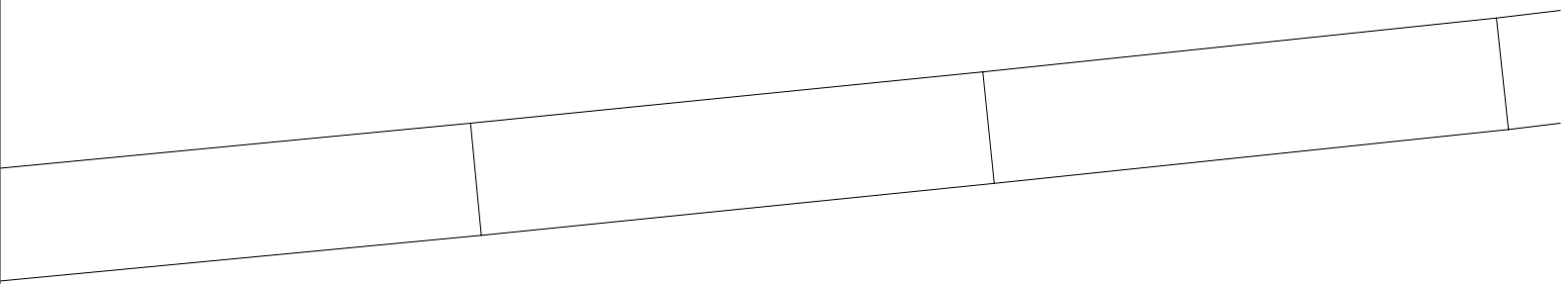

8-10

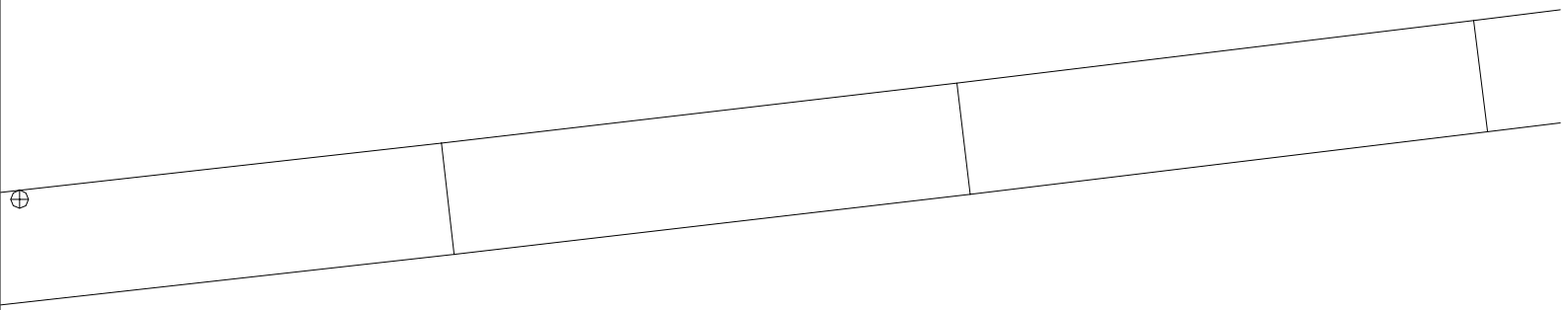

8-11

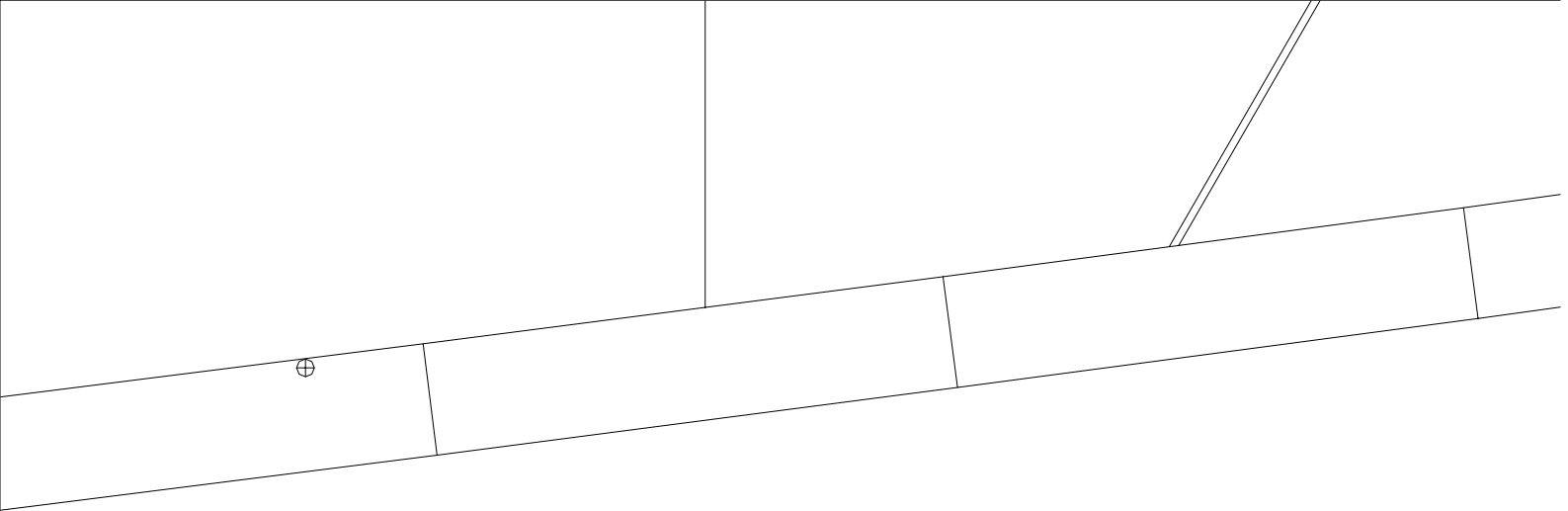

8-12

⊕

8-13

8-14

8-15

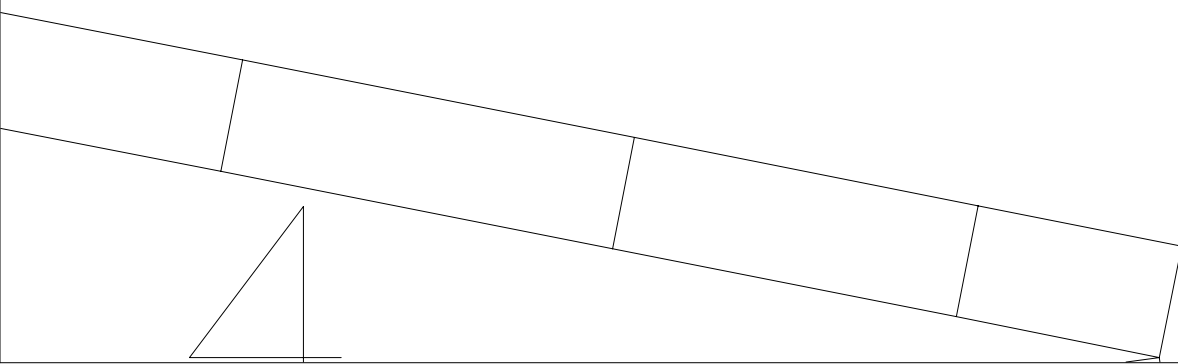

8-16

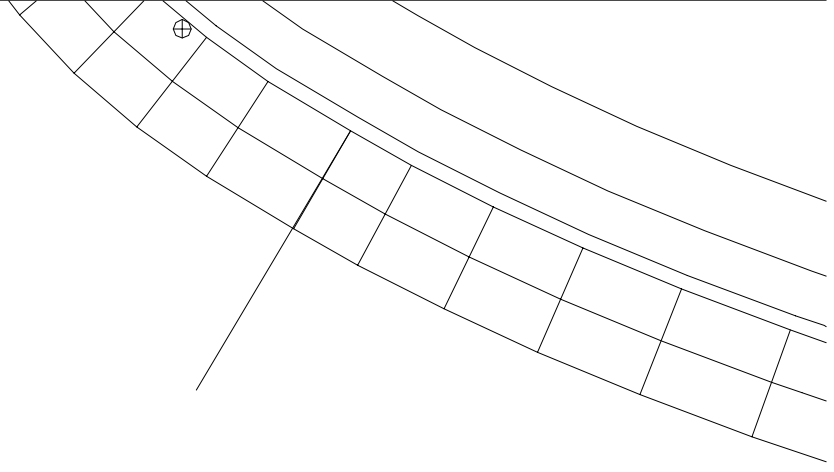

8-1

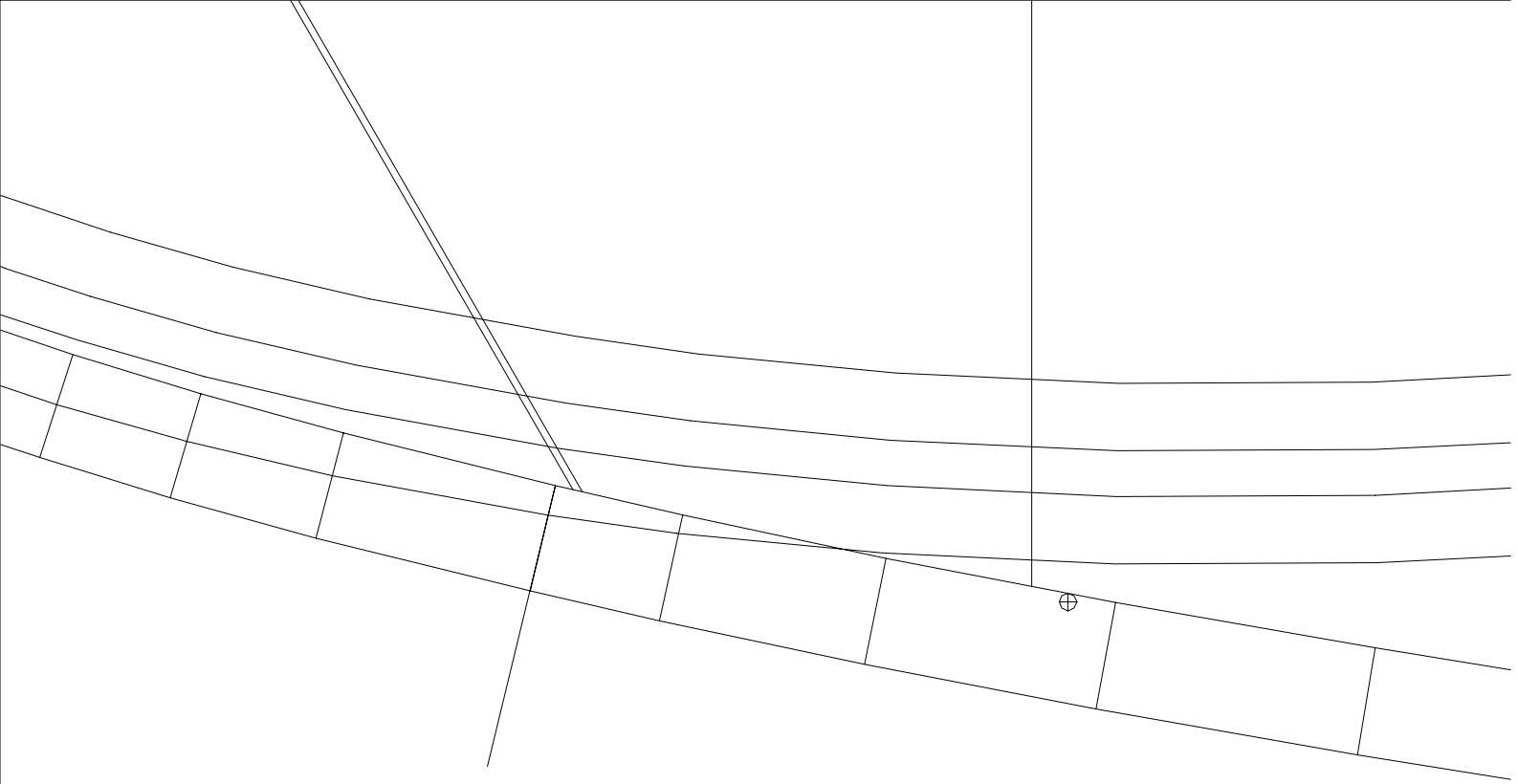

8-2

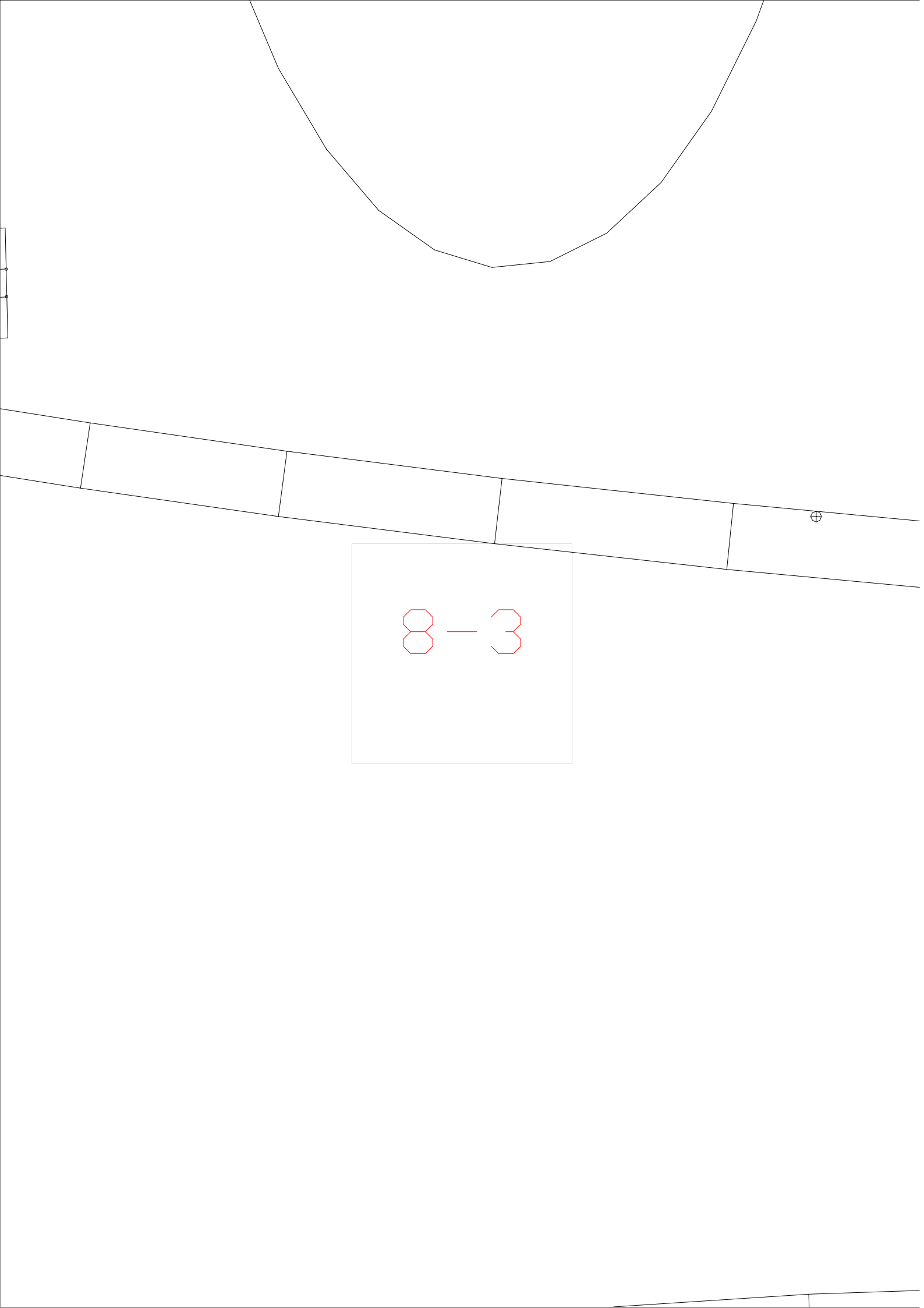

8-3

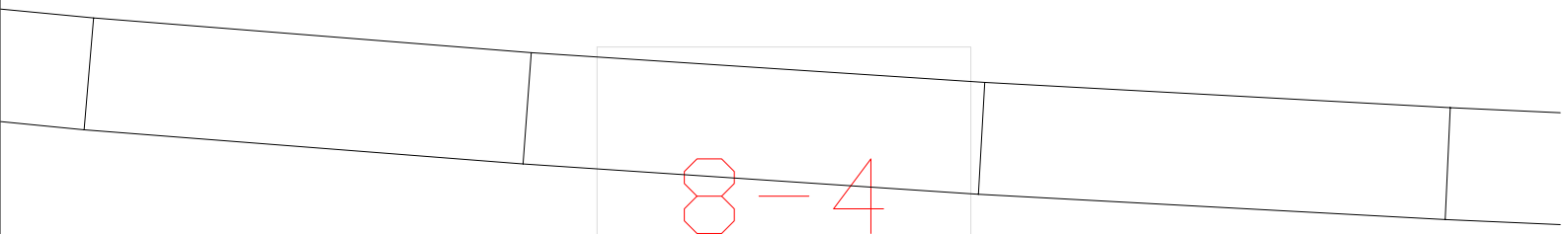
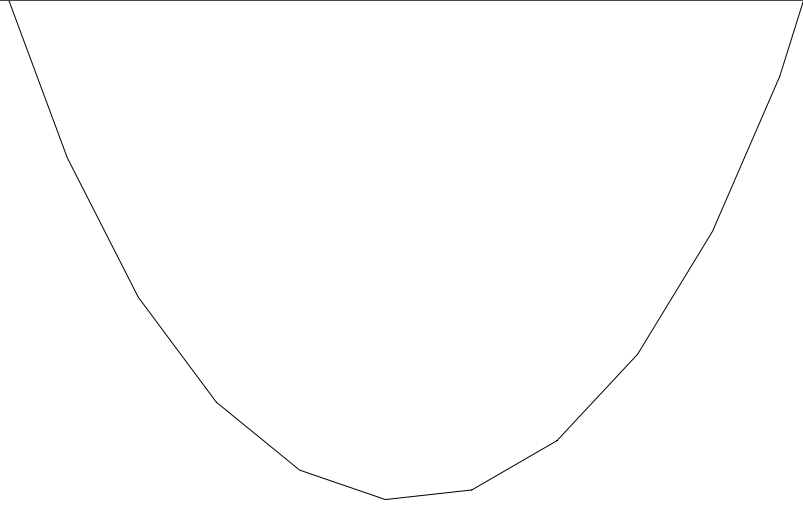

$$8 - 4$$

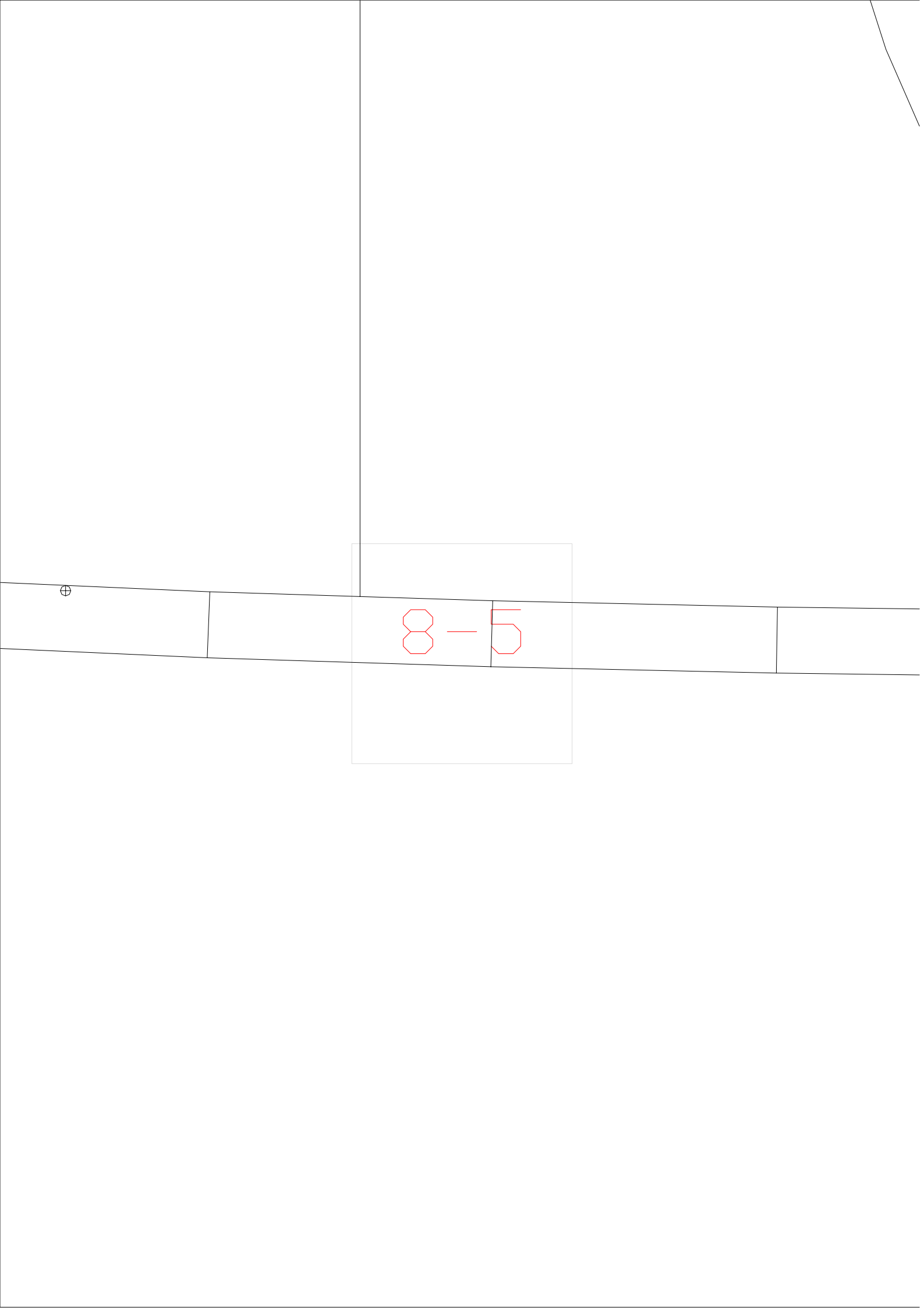

⊕

8-5

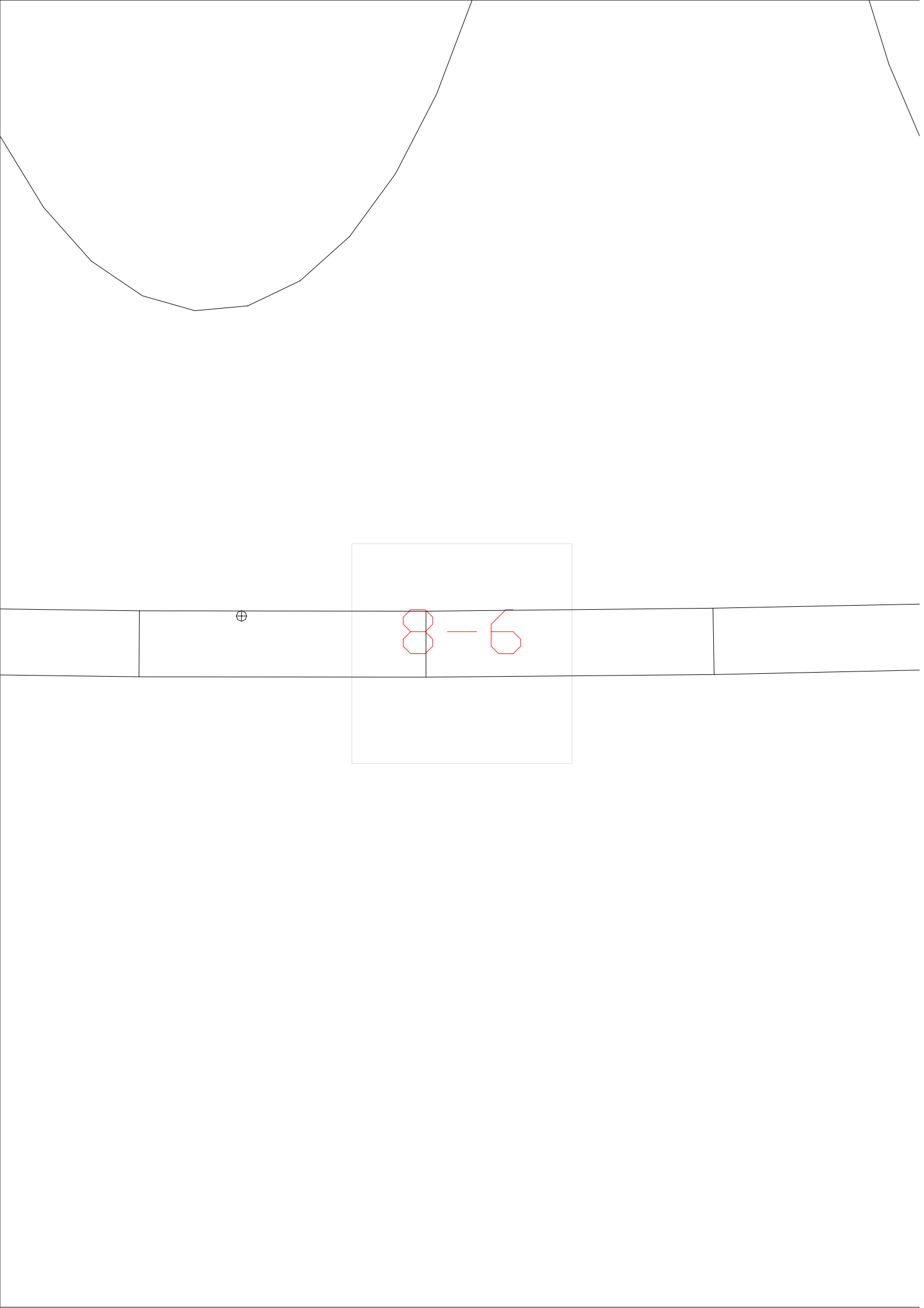

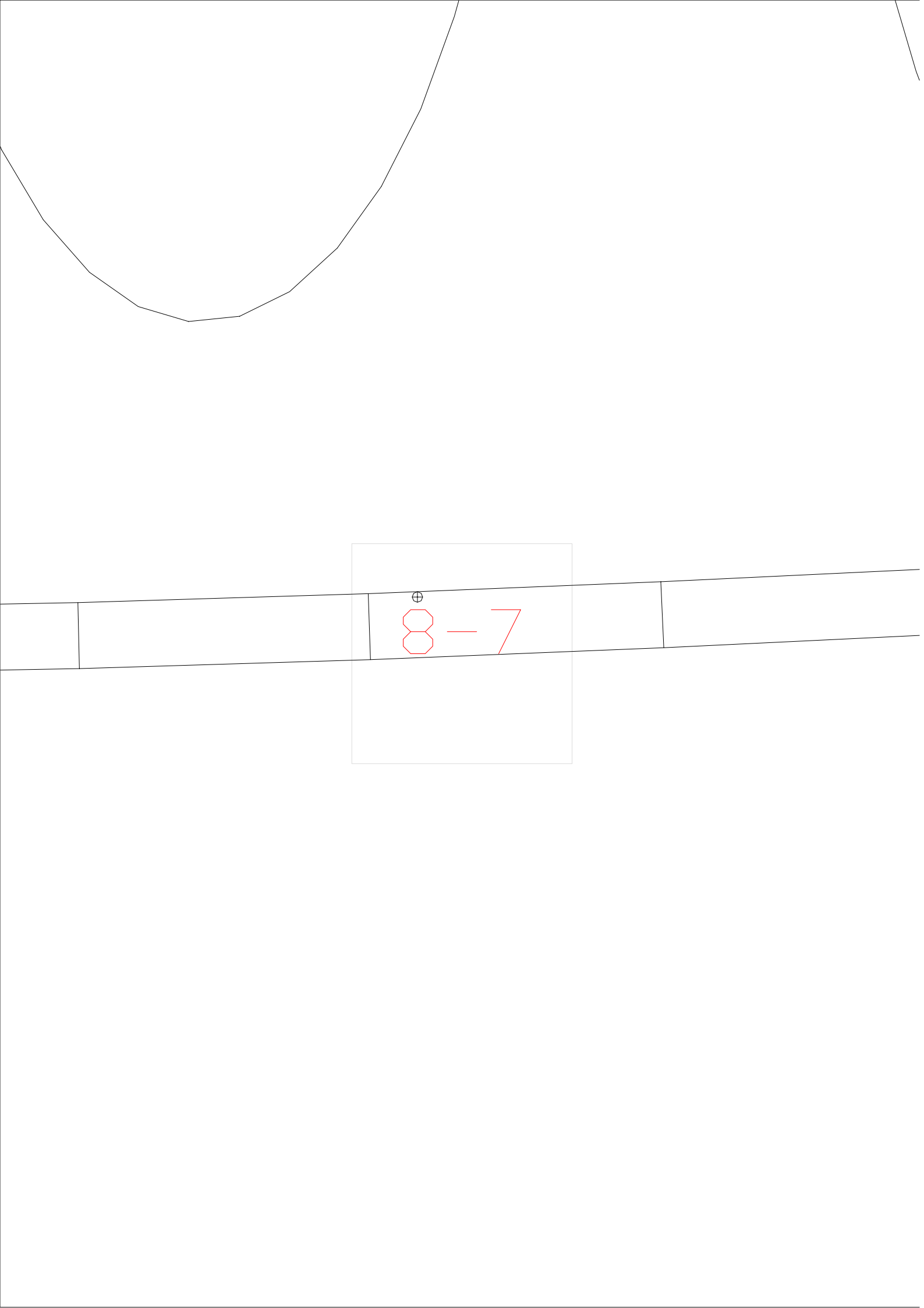

\oplus
8-7

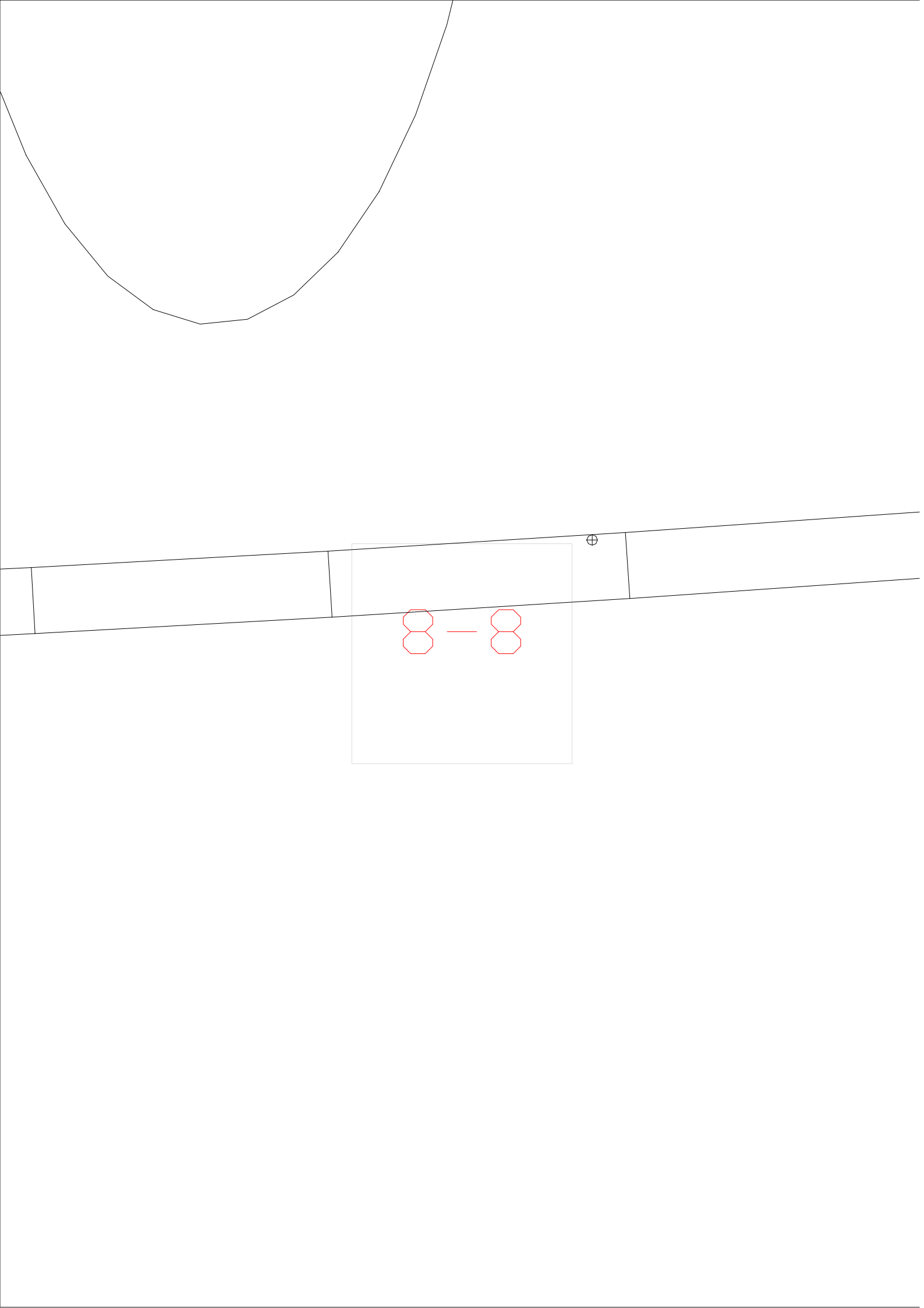



8-9

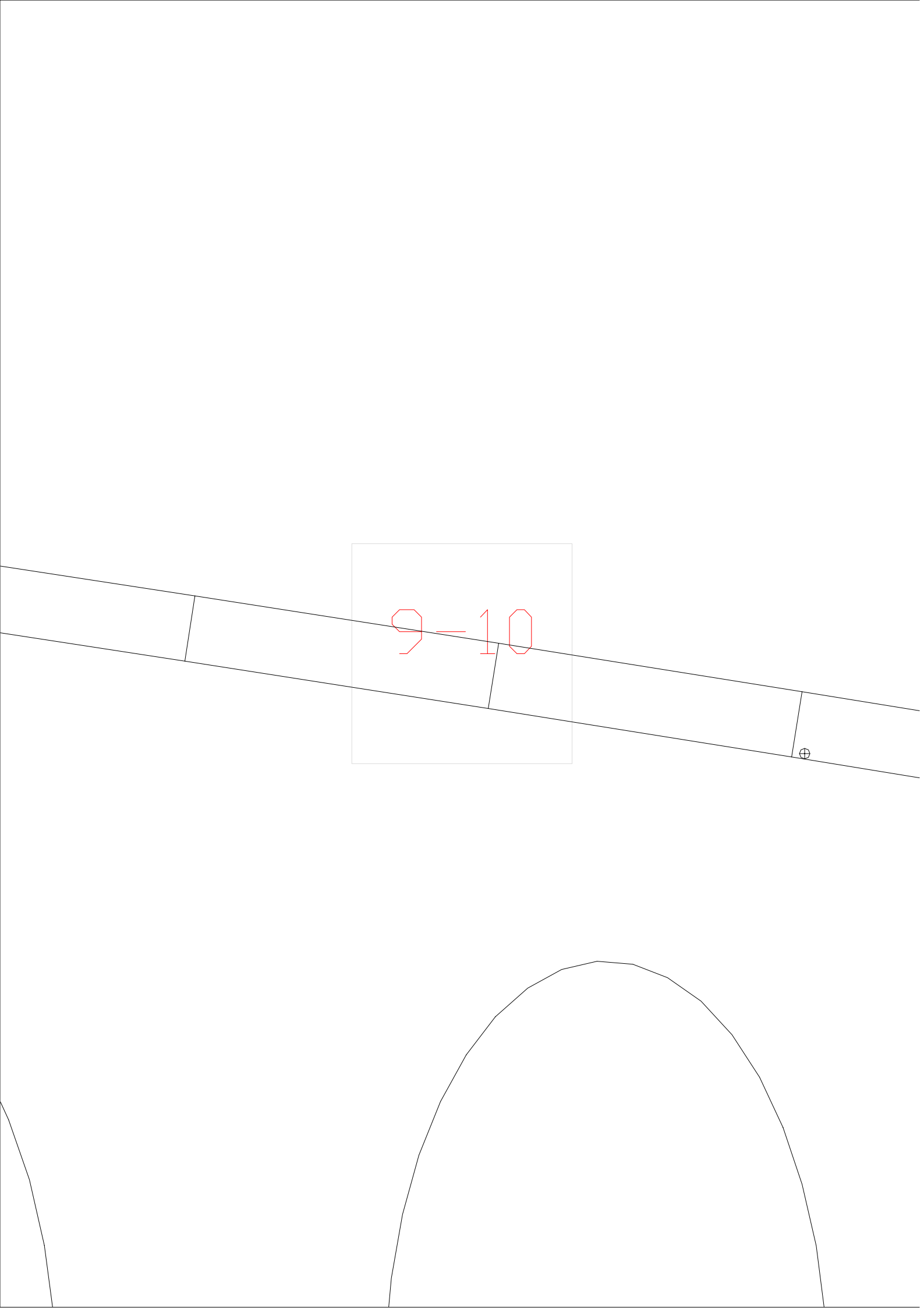

9-11

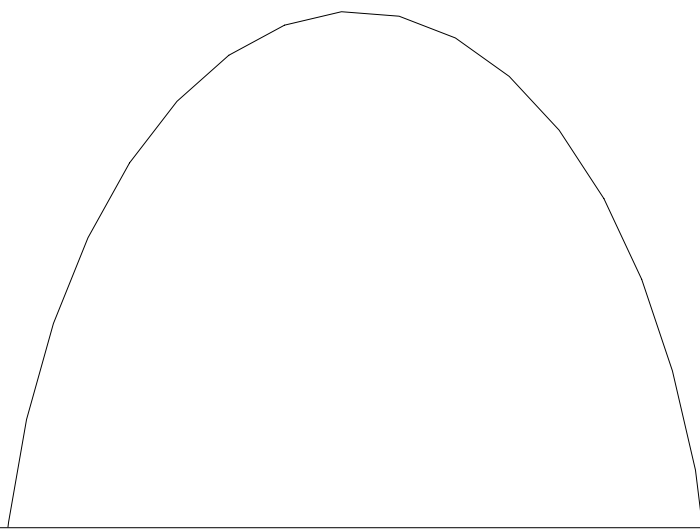
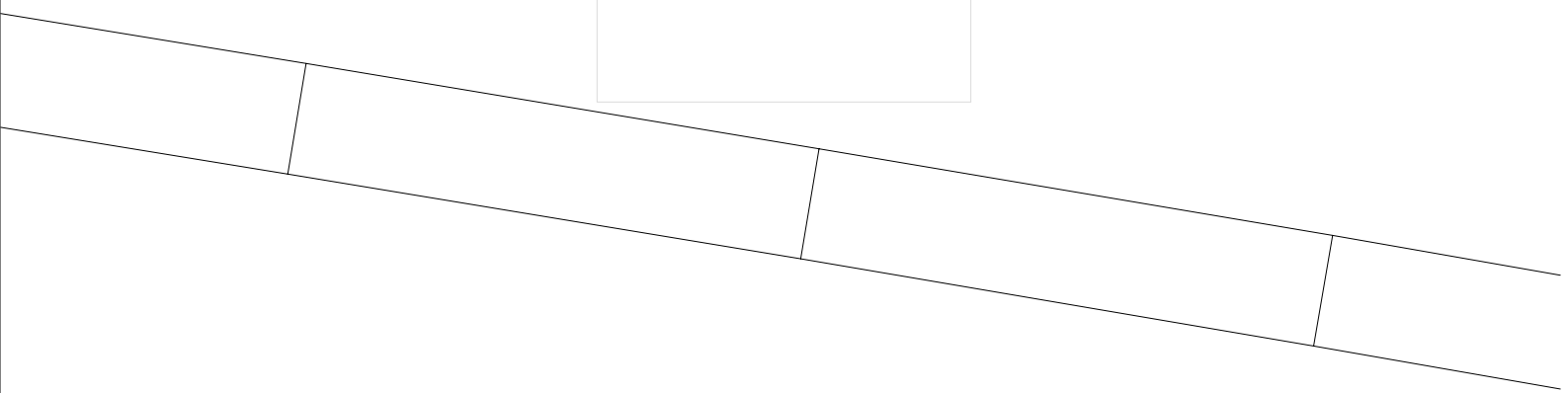

9-12

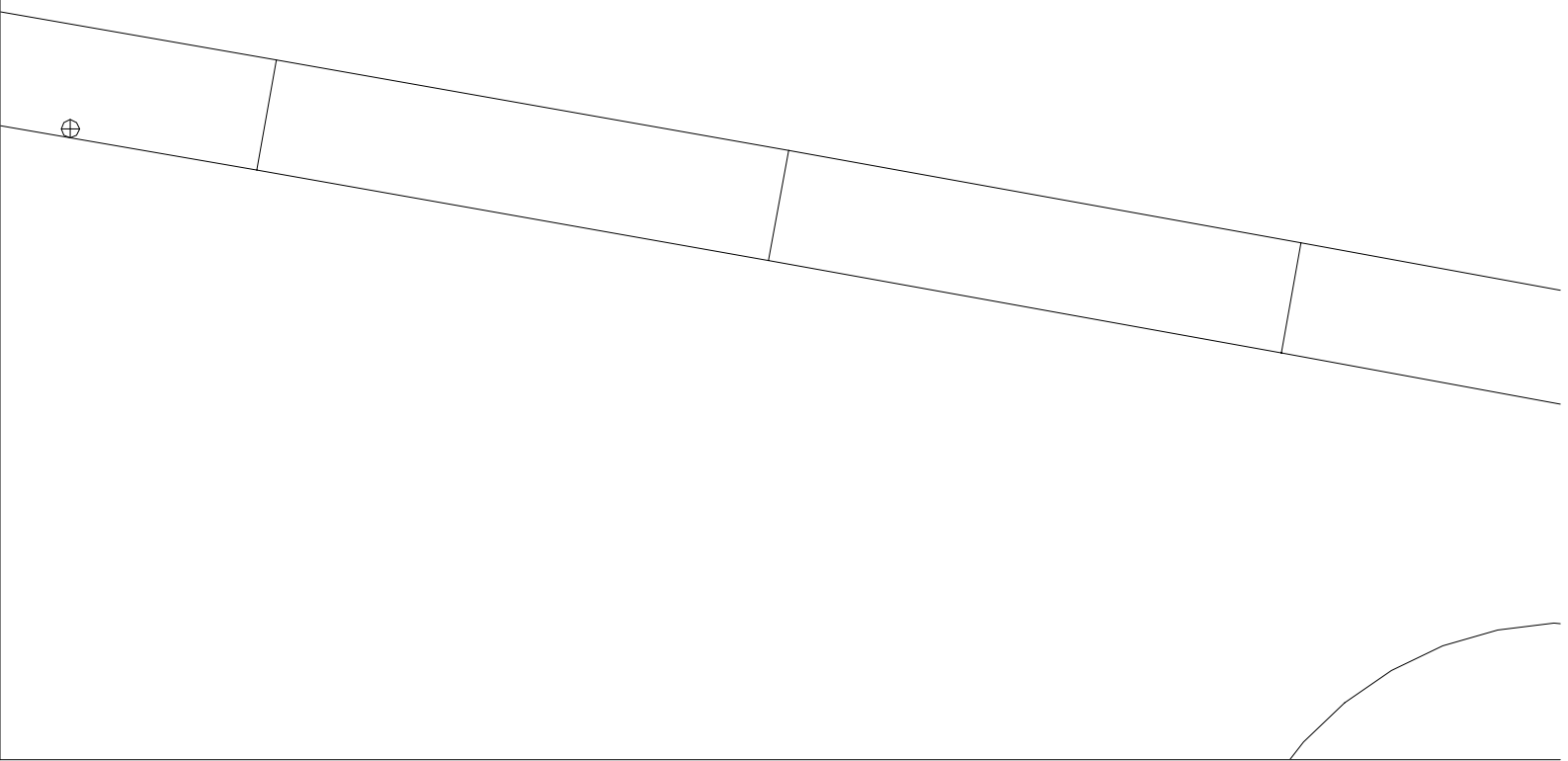

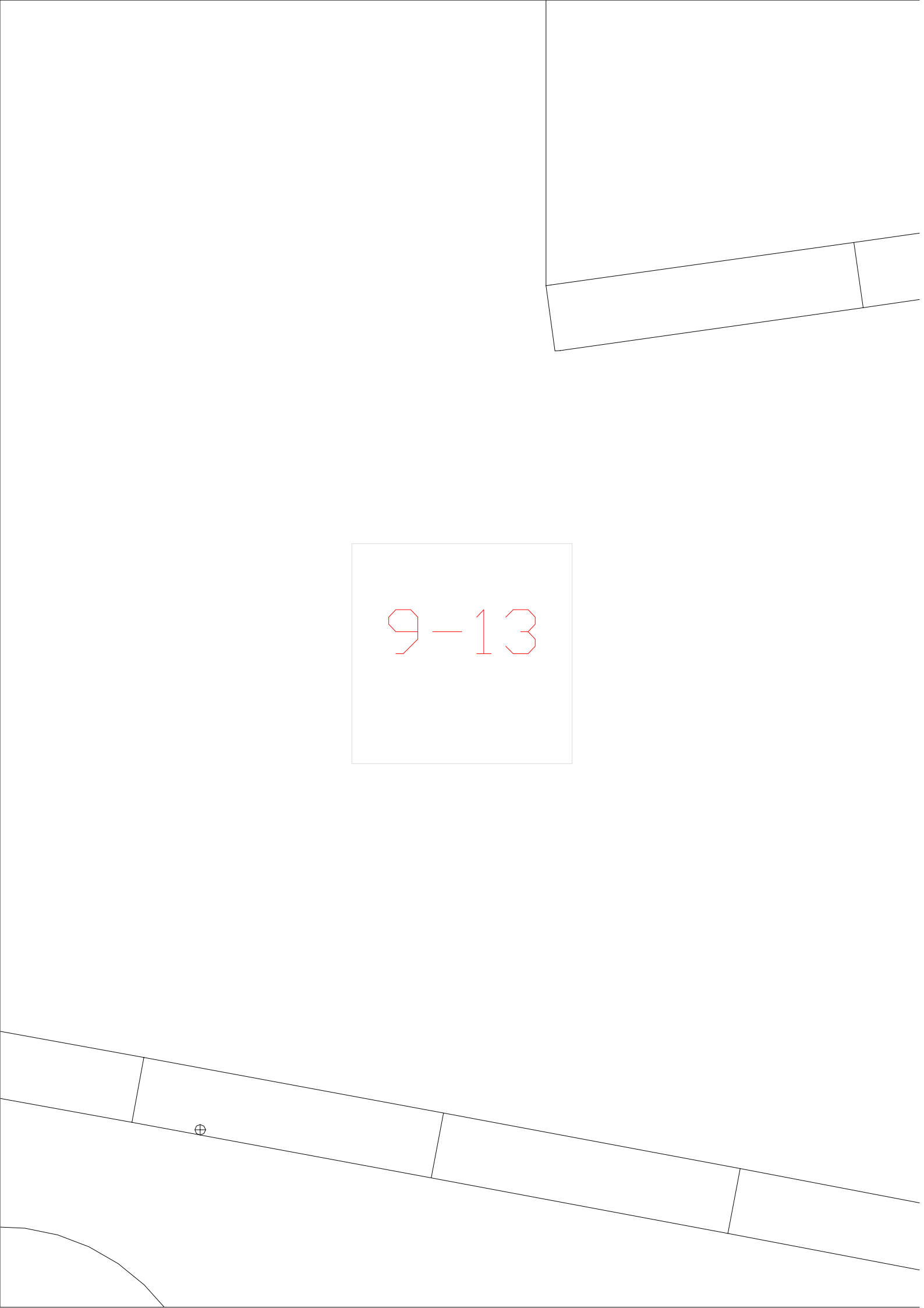

9-13

The image shows a technical drawing of a tapered shaft. The shaft is oriented vertically and tapers from top to bottom. It features a central longitudinal hole and a square hole located on the lower portion of the shaft. The drawing is composed of black lines on a white background. A central rectangular box contains the text '9-13' in red. The shaft's profile is defined by two parallel lines that converge towards the top. The central hole is a simple vertical line. The square hole is a square shape with a small circle in the center, indicating a hole or a specific feature. The drawing is partially cut off at the top and bottom edges.

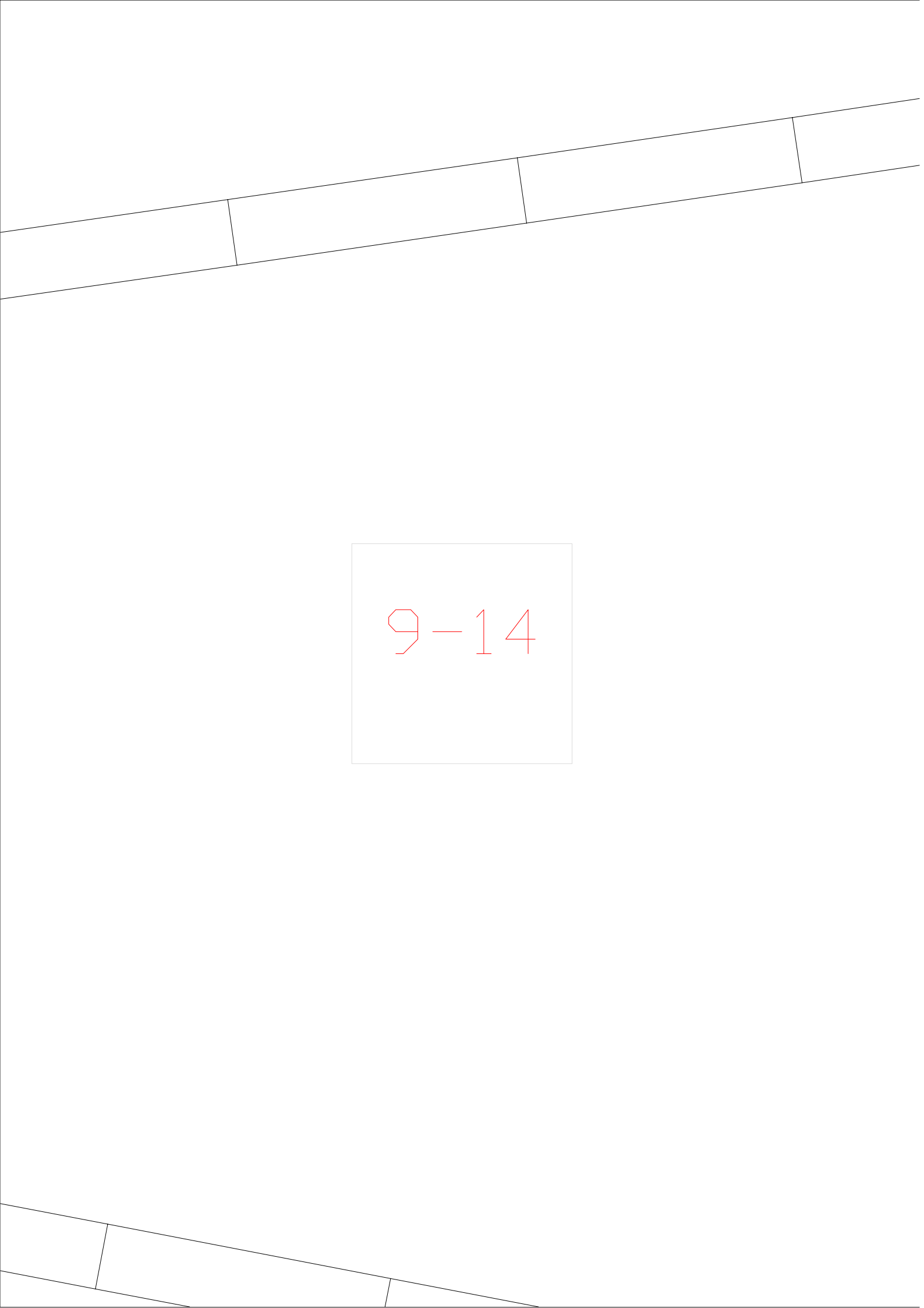

9-14

--	--	--	--

9-15

9-16

9-1

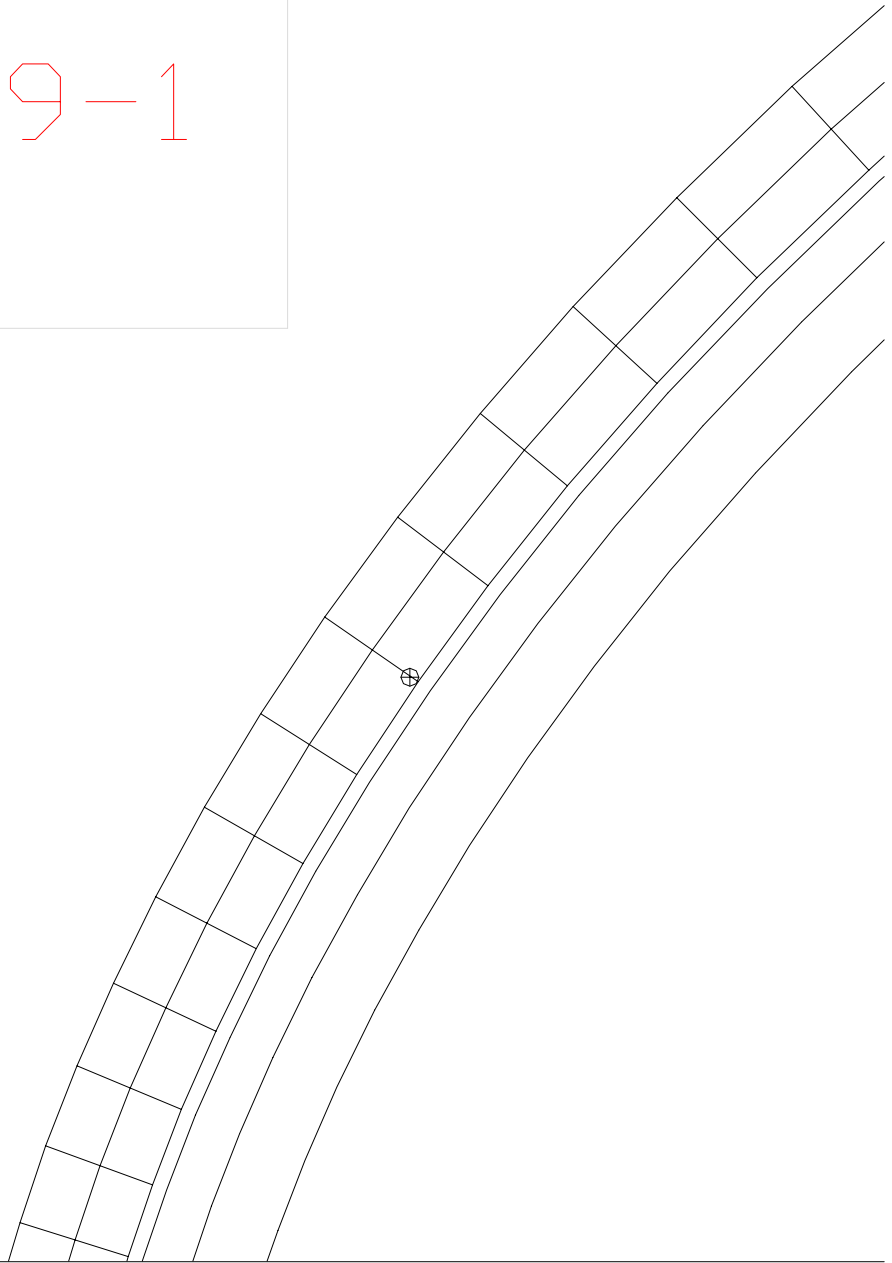

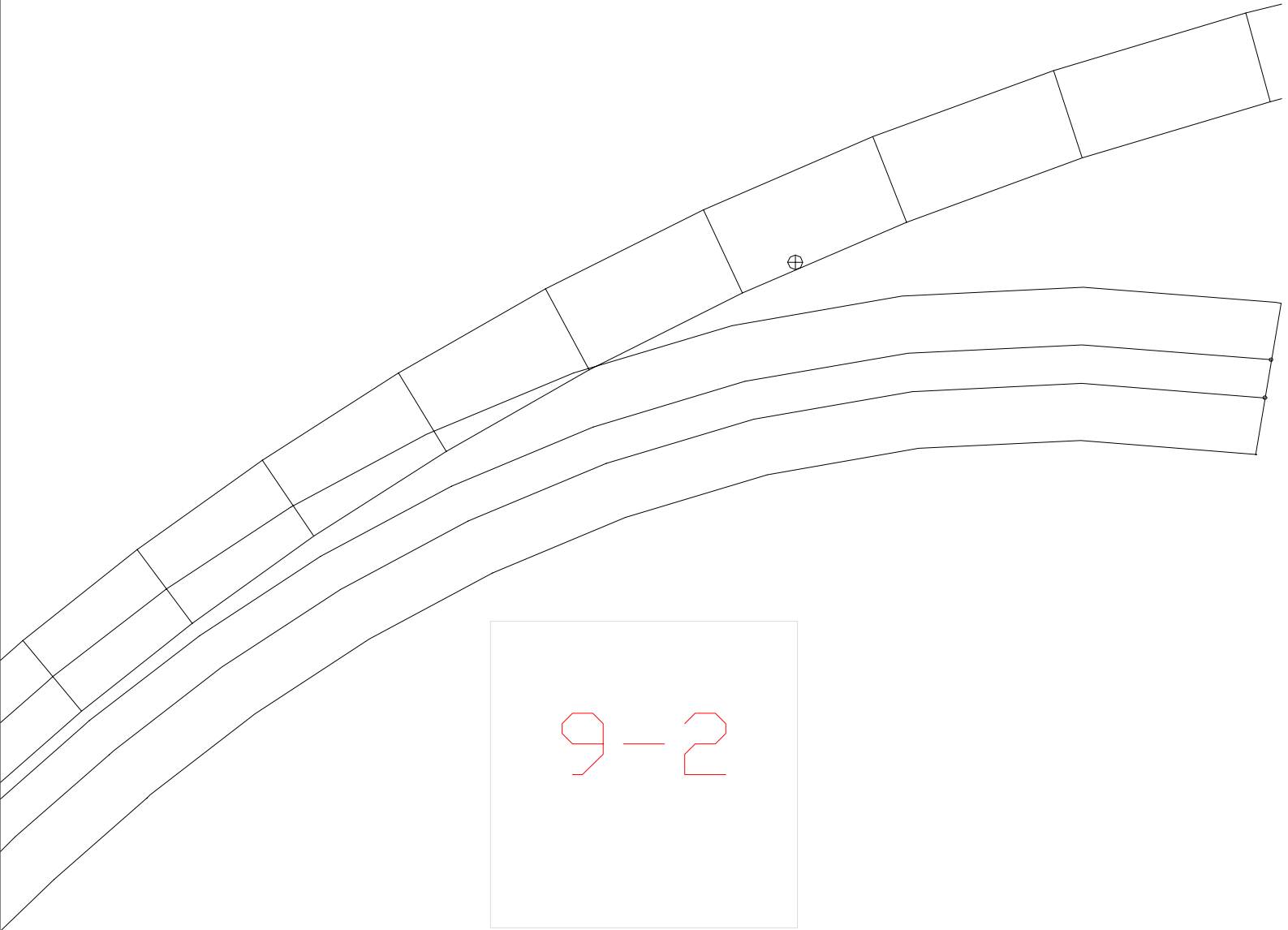

9-2

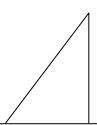

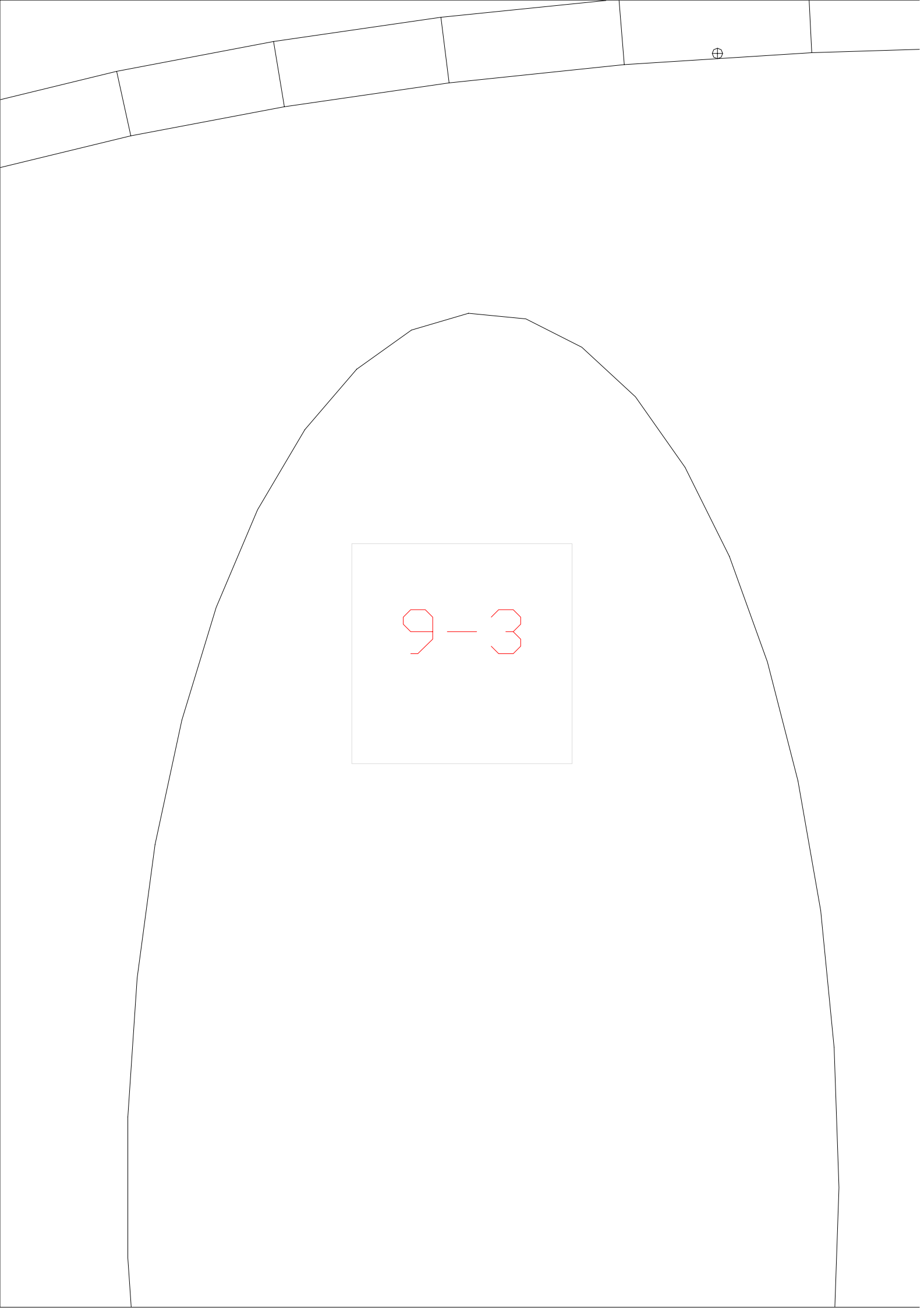

9-3

9-4

--	--	--	--

9-5

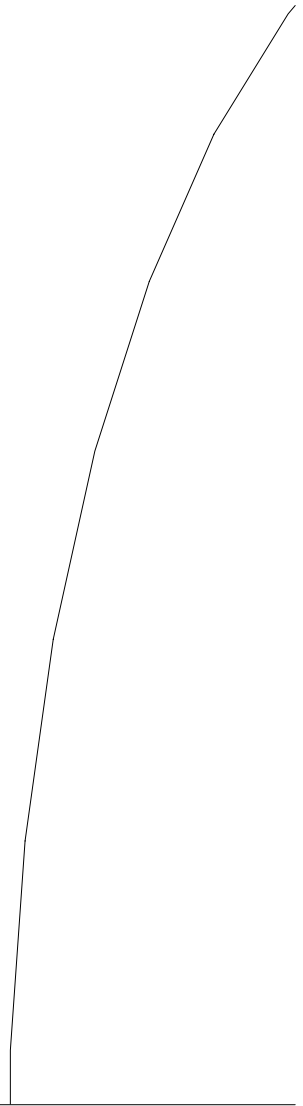

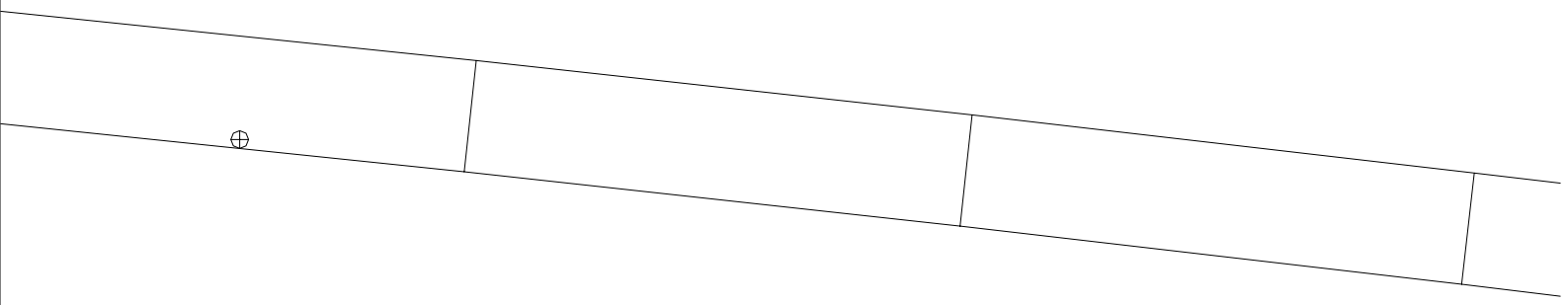

9-6

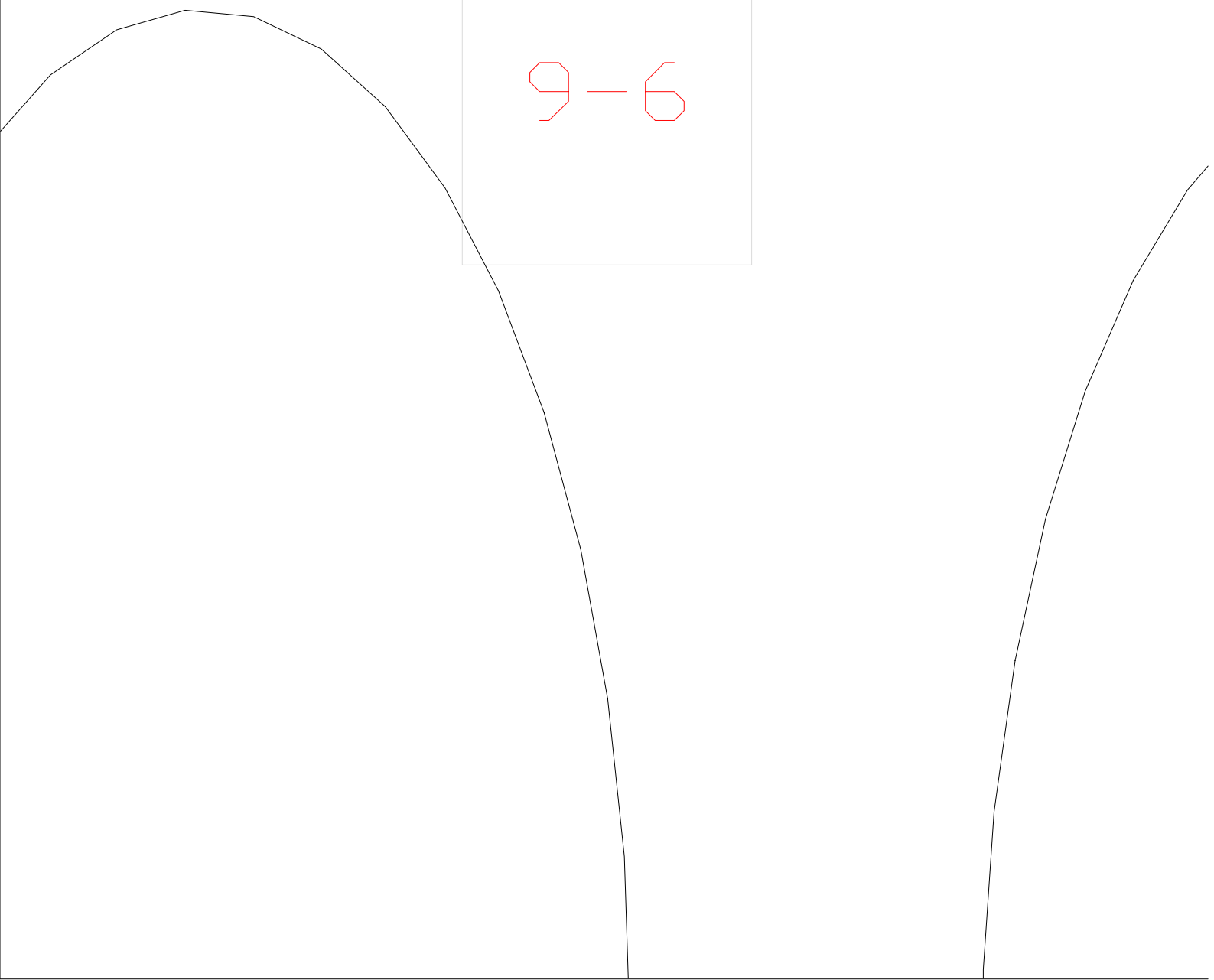

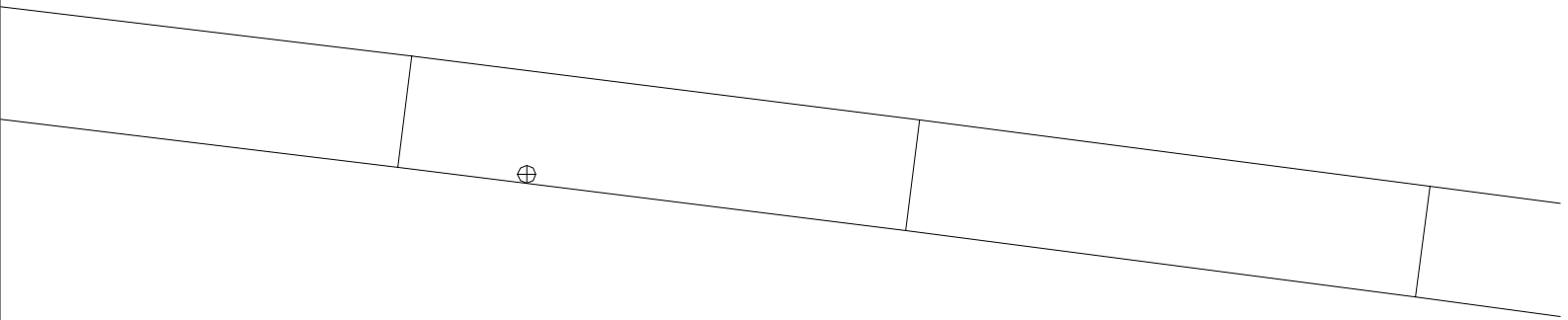

9-7

