

10-10

10-11

10-12

10-13

10-14

10-15

10-1

10-2

10-3

$$10 - 4$$

$$10 - 5$$

10-6

$$10 - 7$$

$$10 - 8$$

10-9

1-10

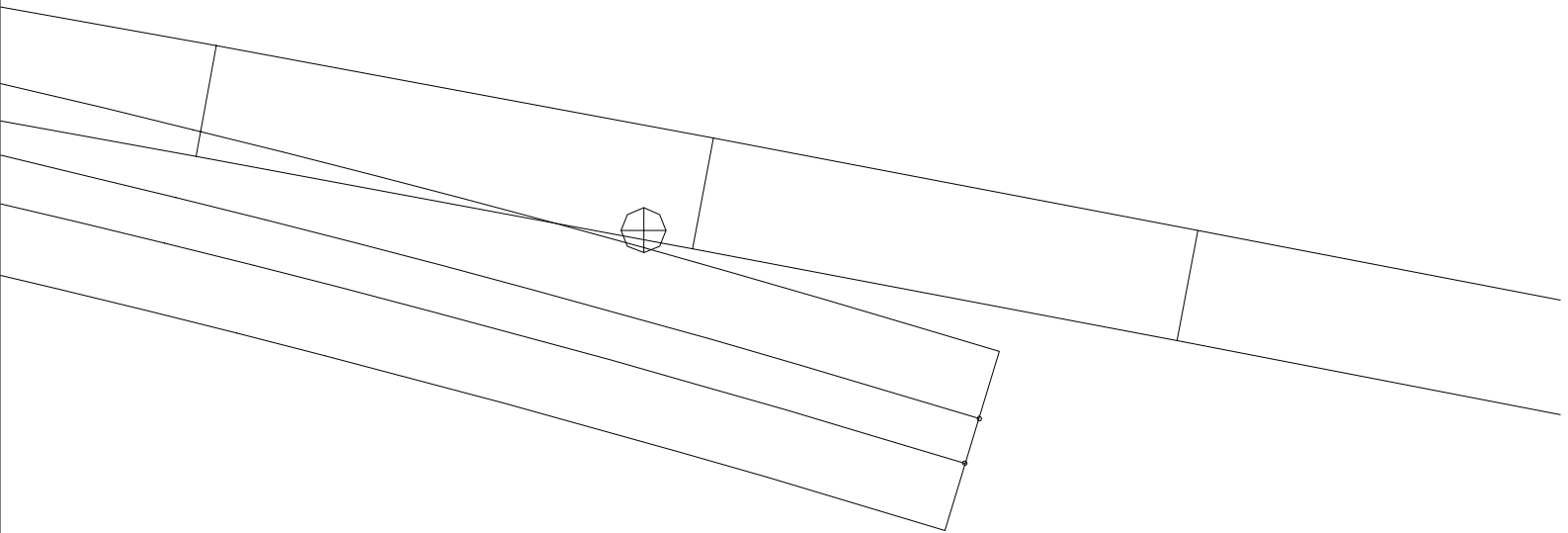

1-11

1-12

1-13

1-15

1-1

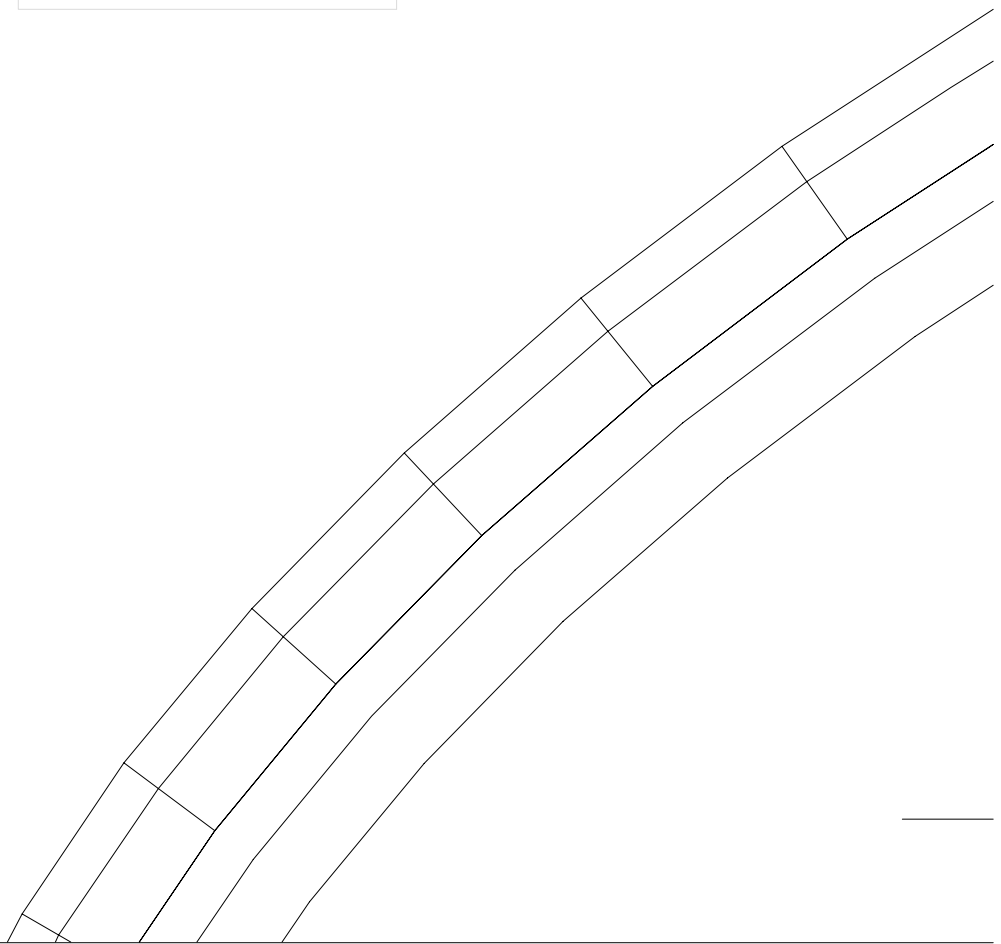

—

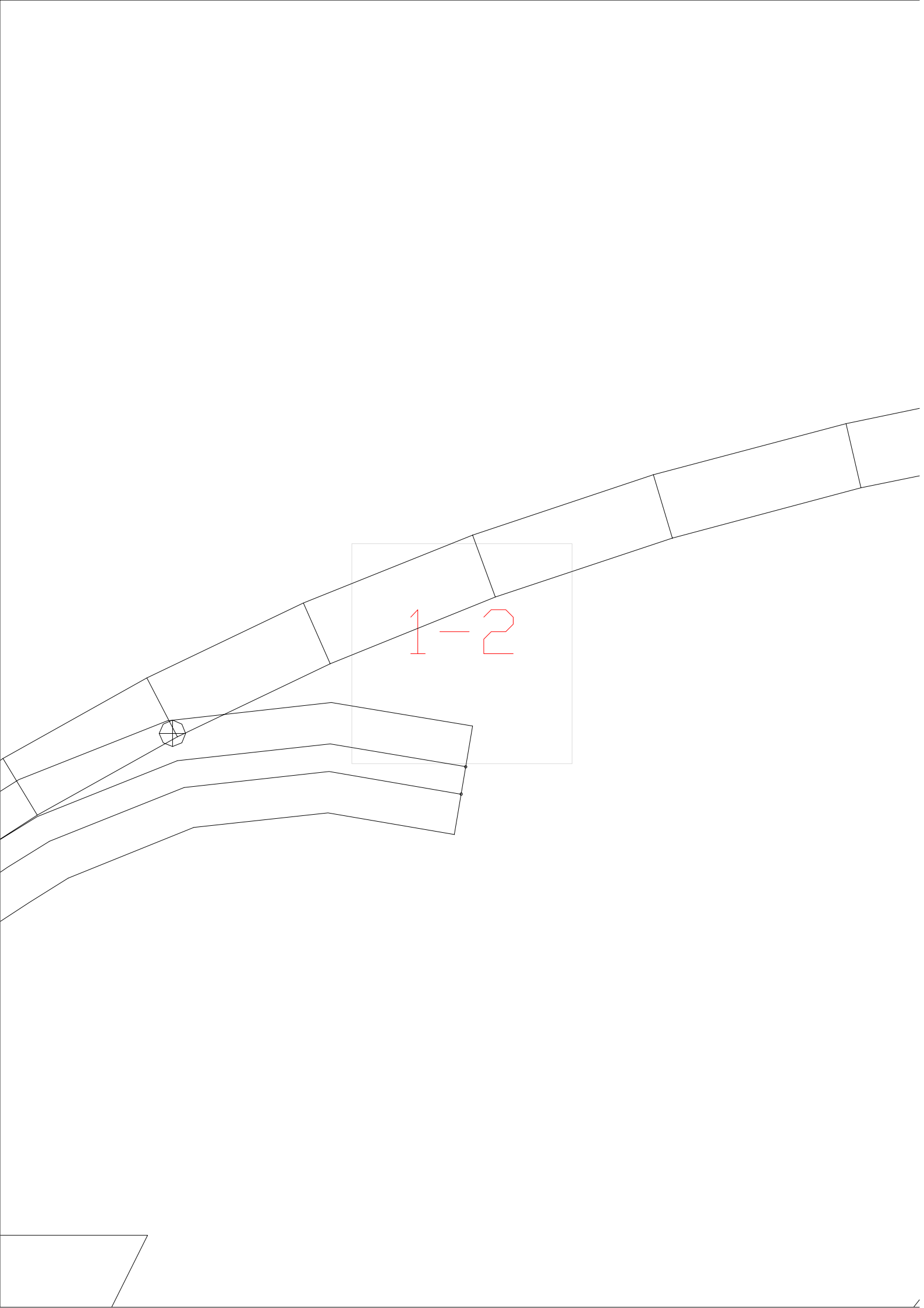

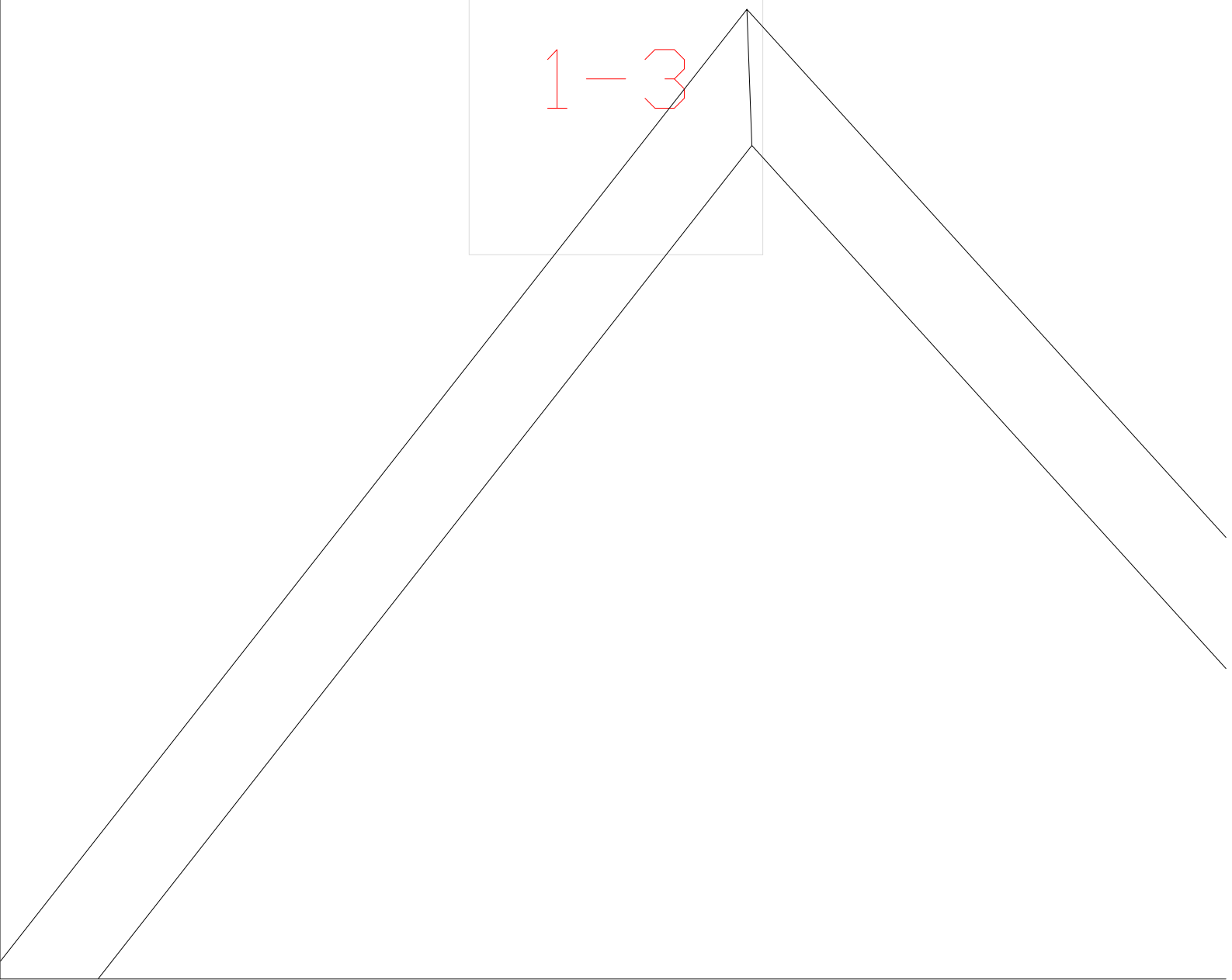
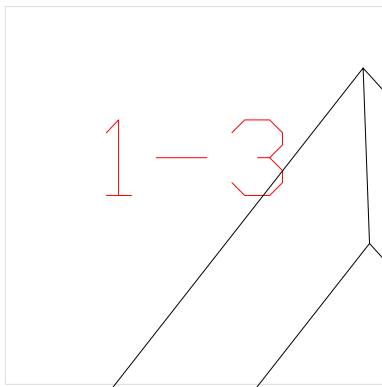
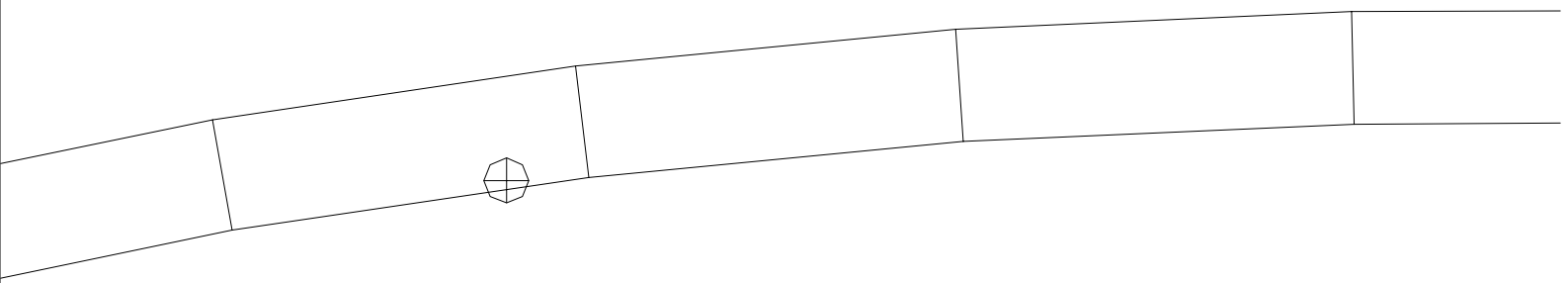

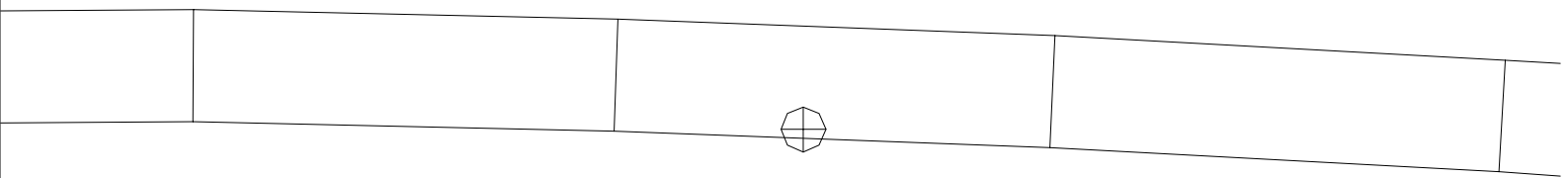

1-4

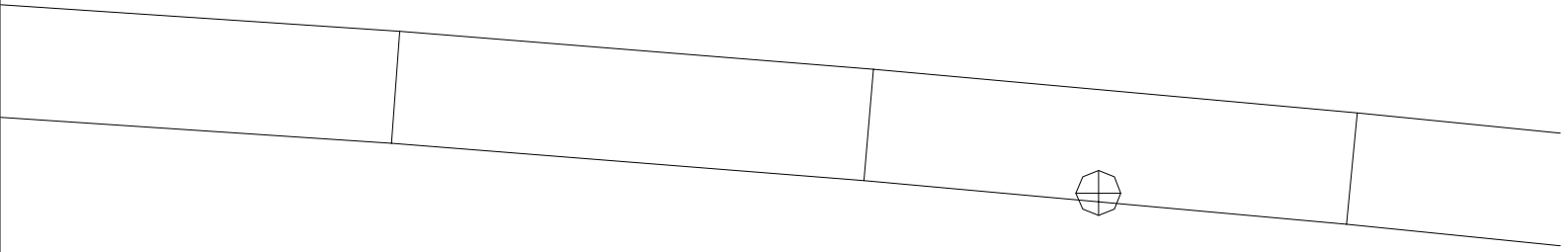

1-5

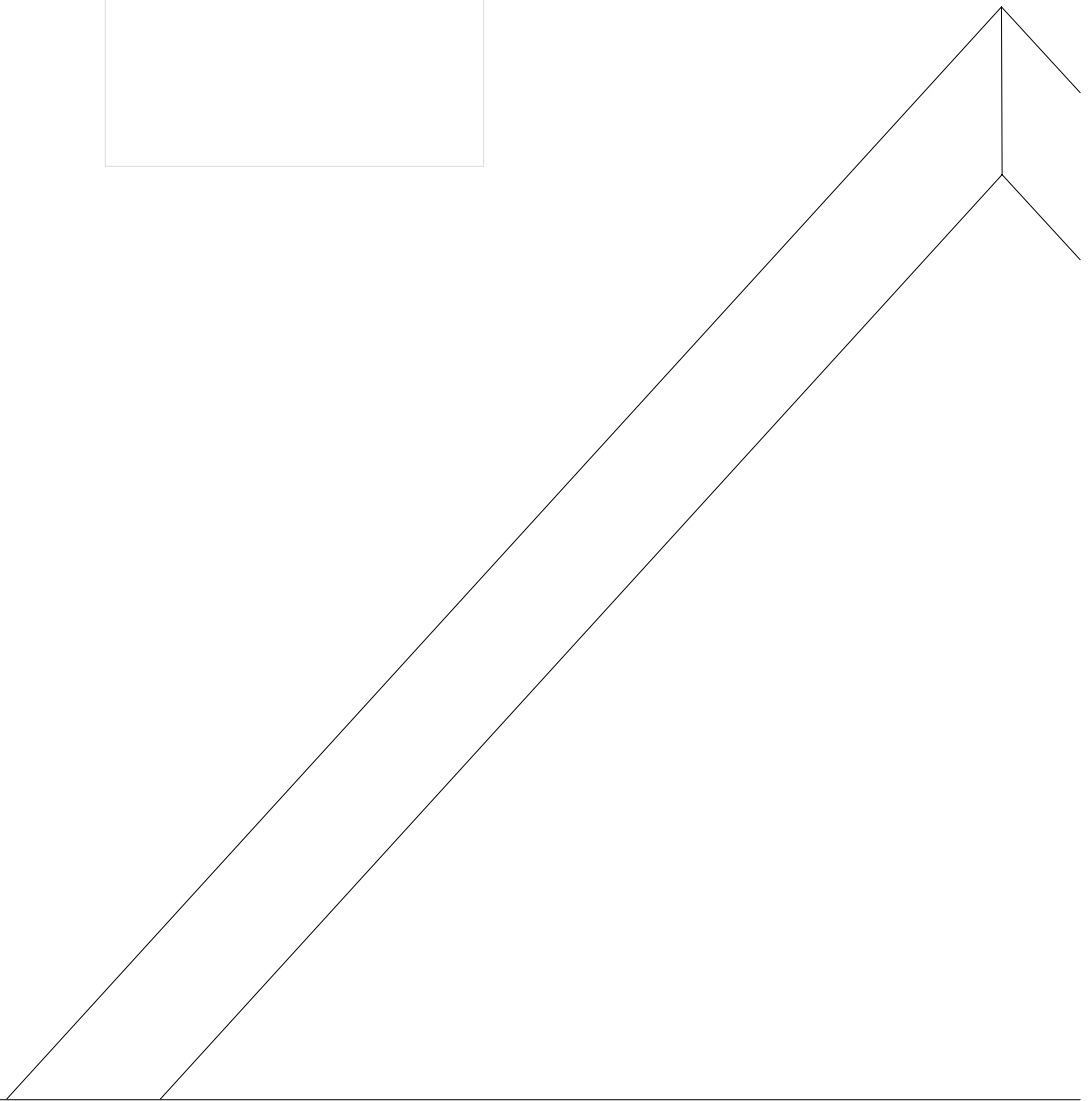

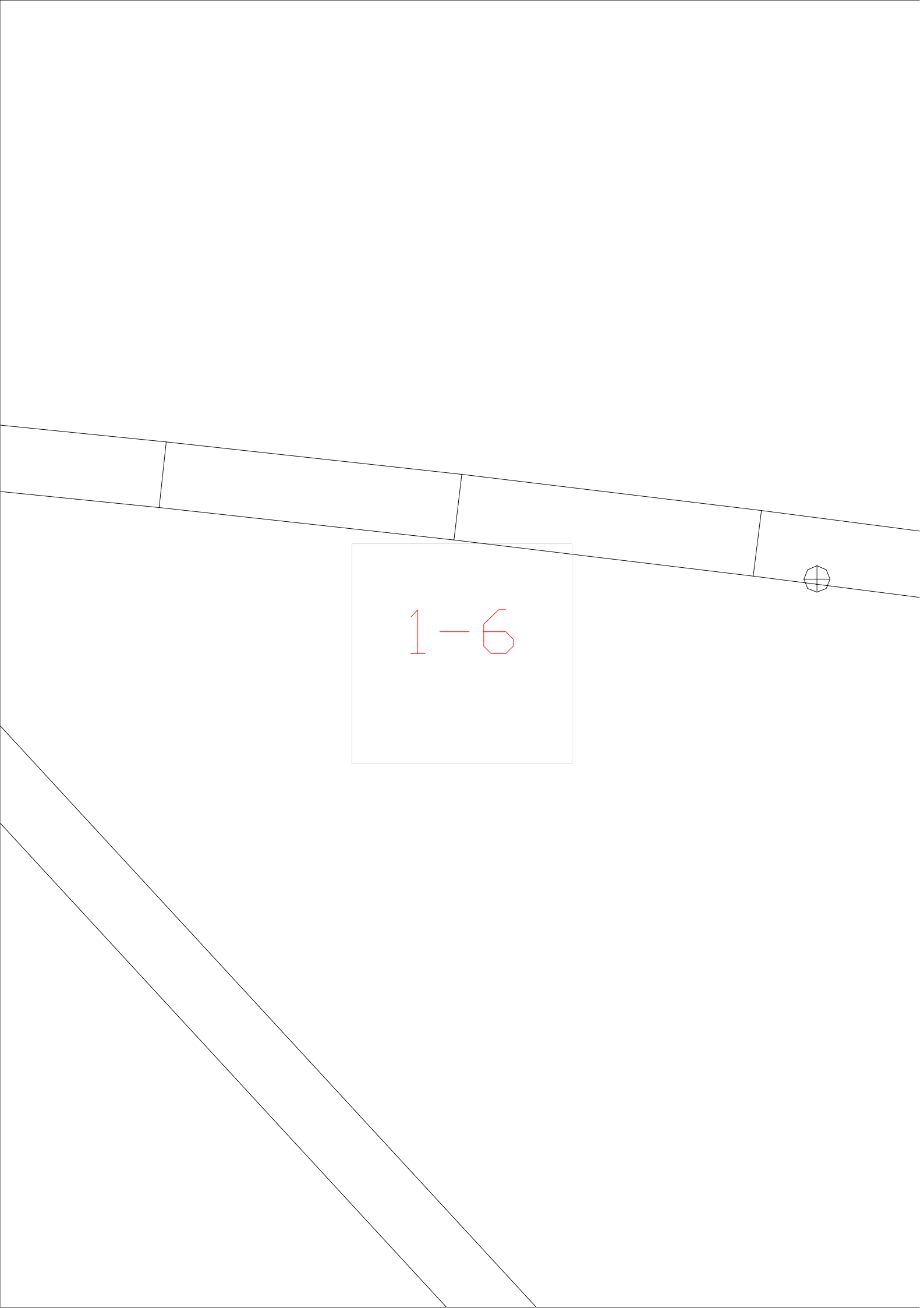

1-6

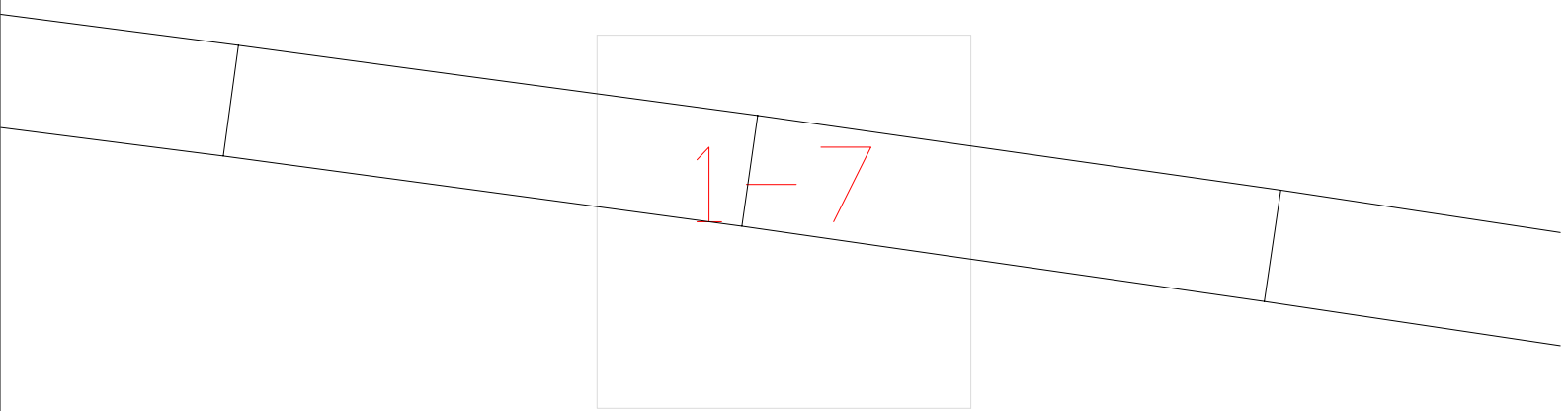

1-8

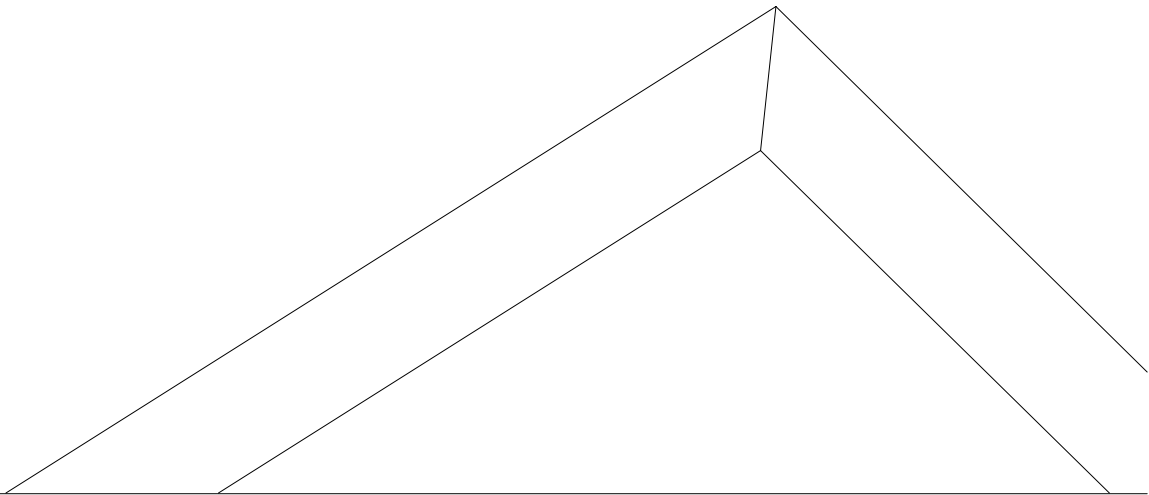
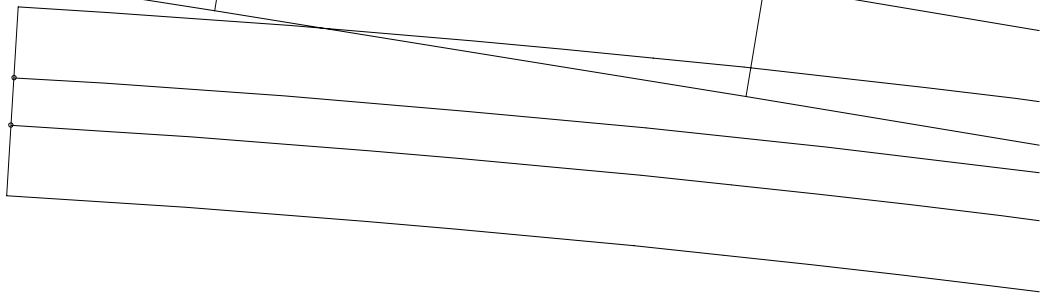

1-9

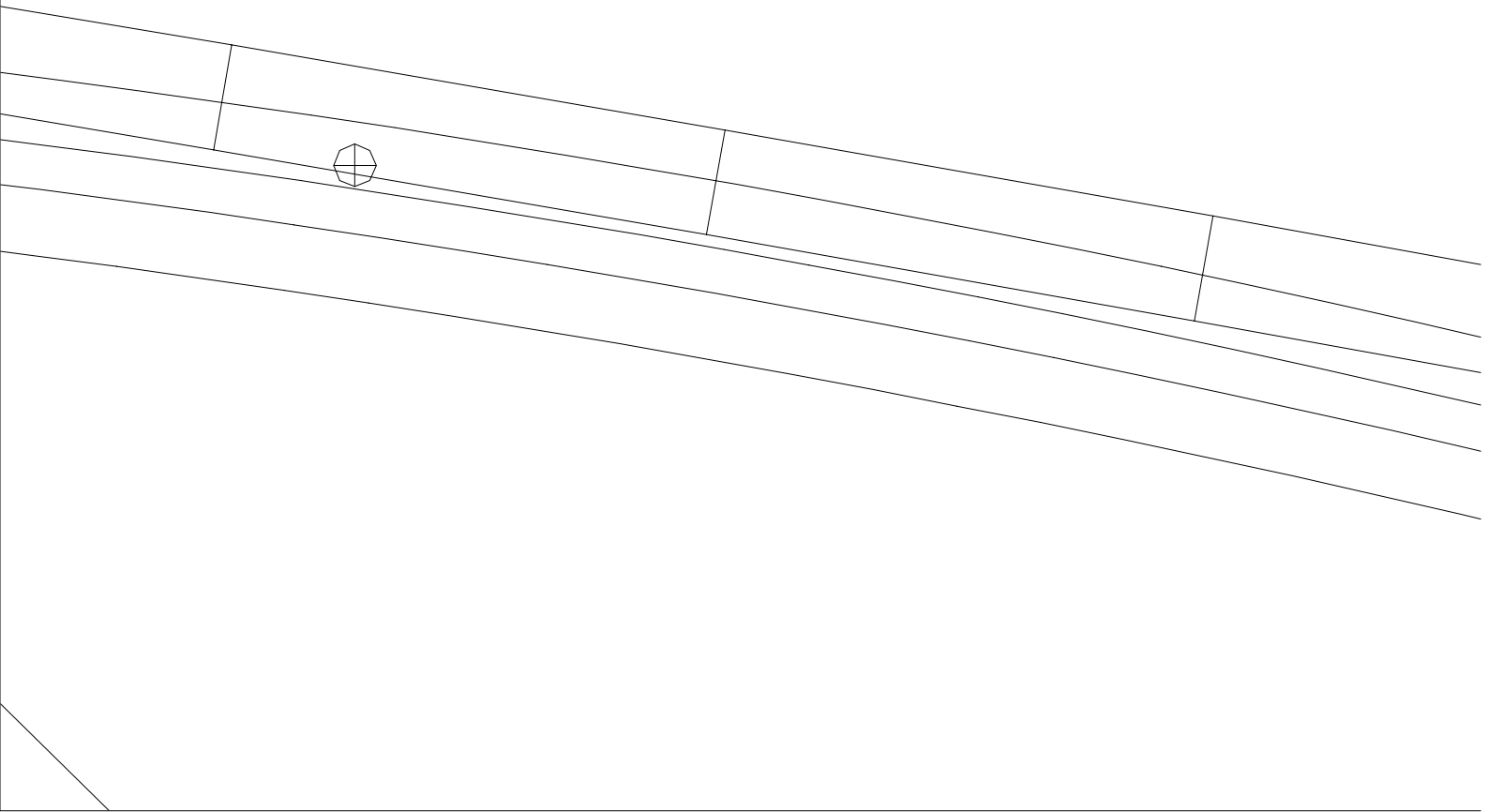

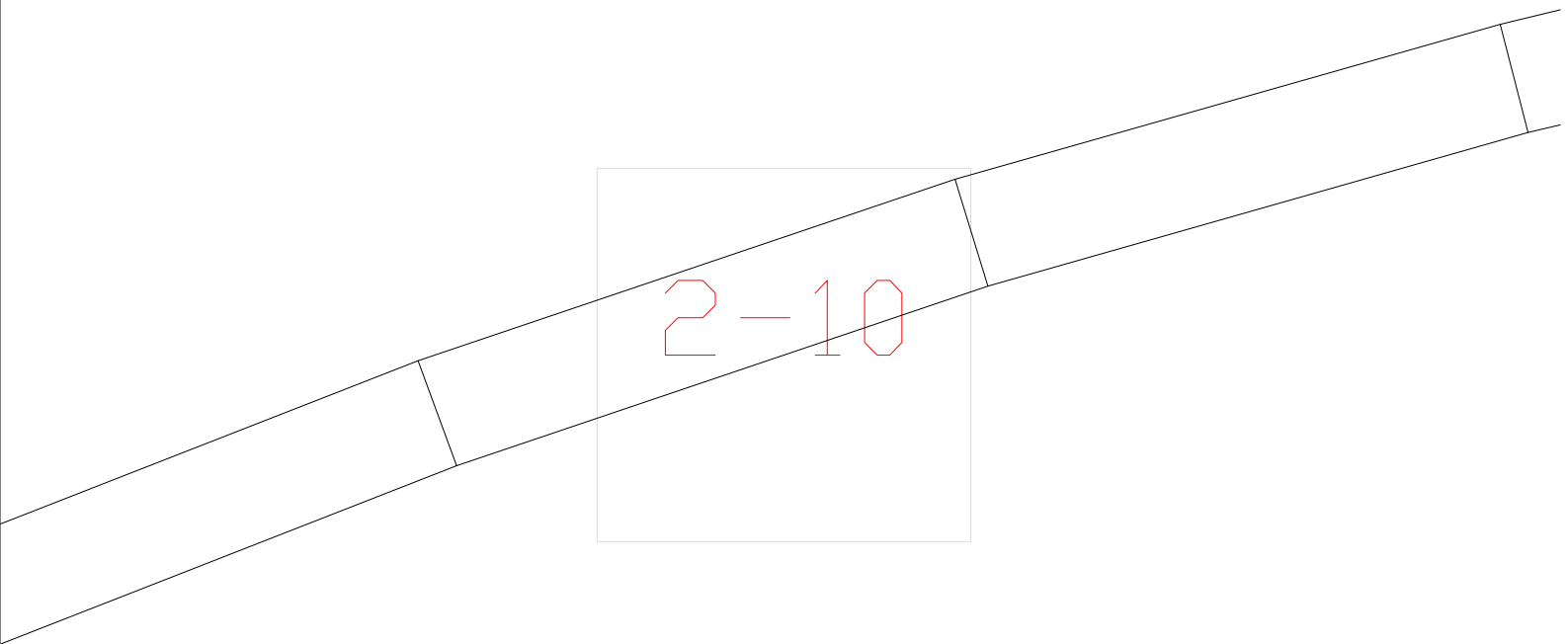

2-10

2-11

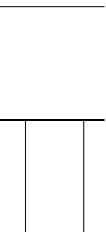

2-14

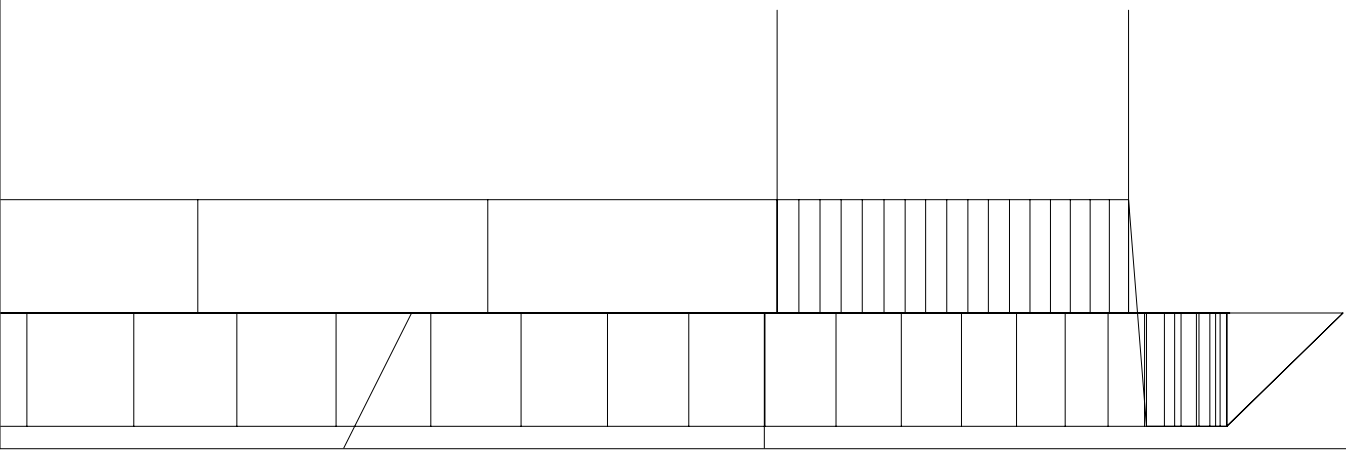

2-15

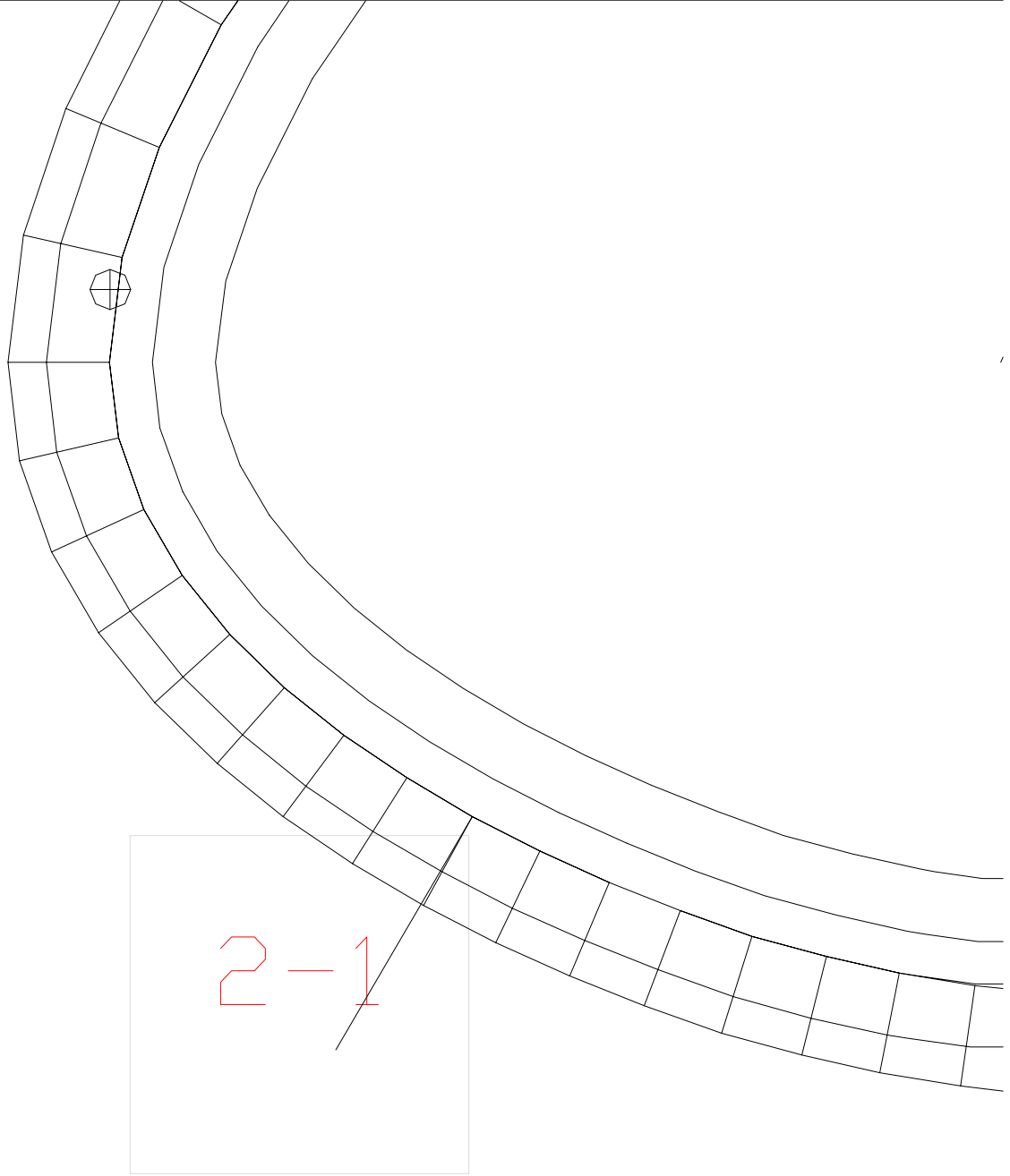

2-1

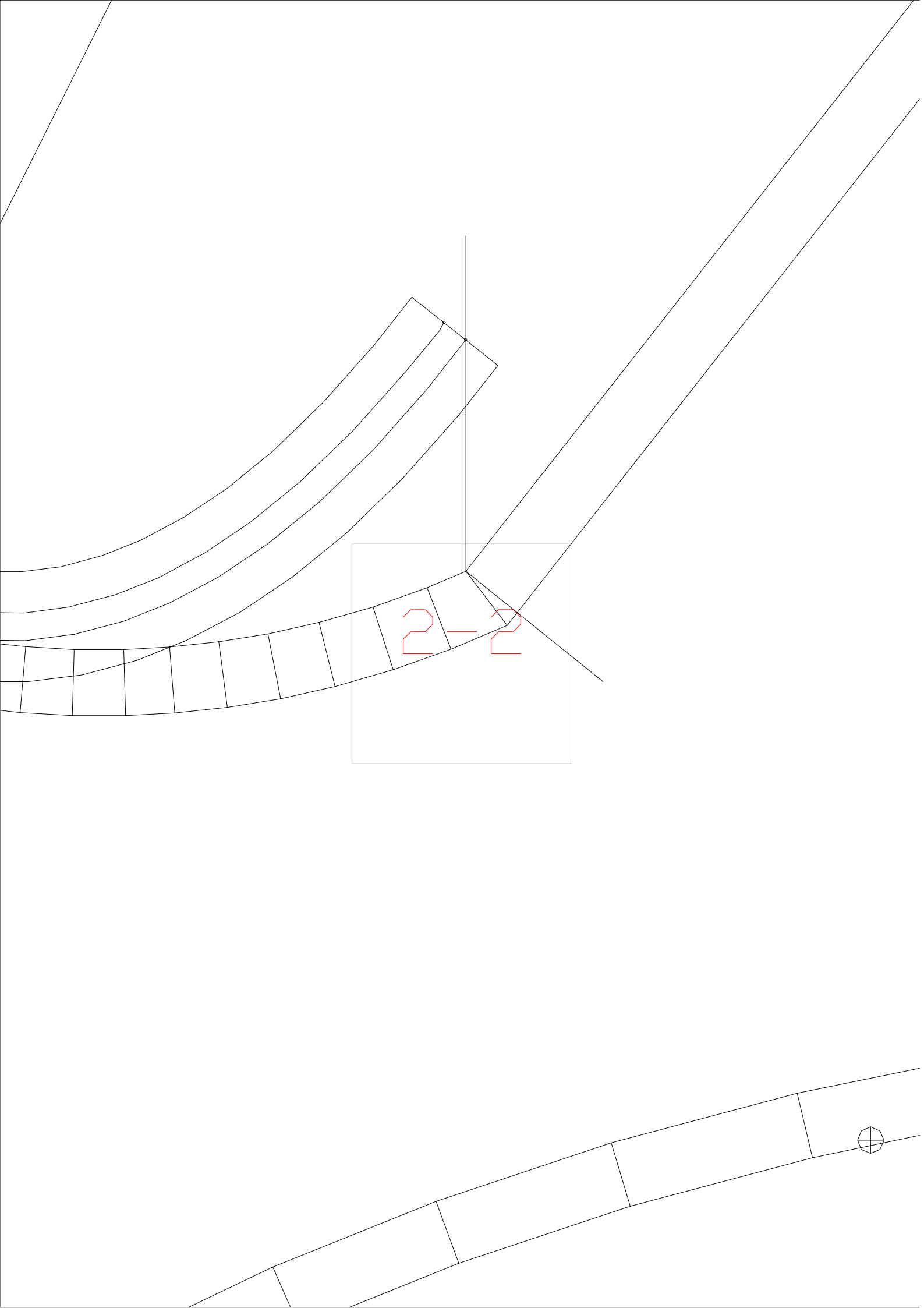

2-3

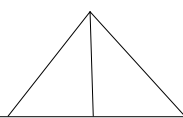
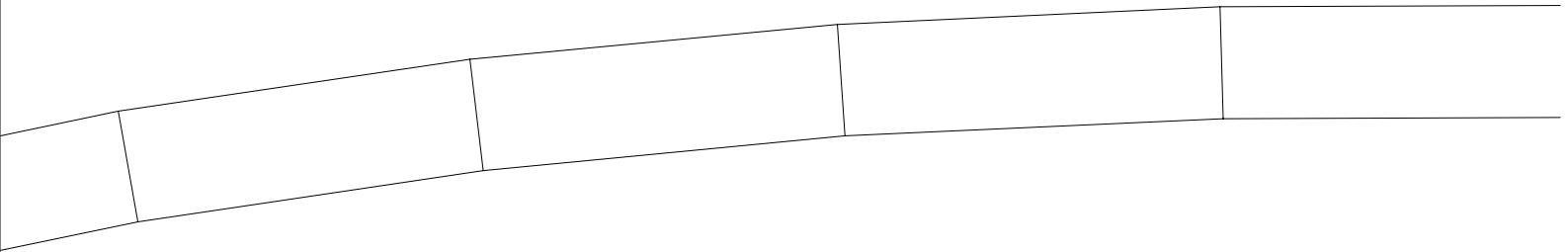

2-4

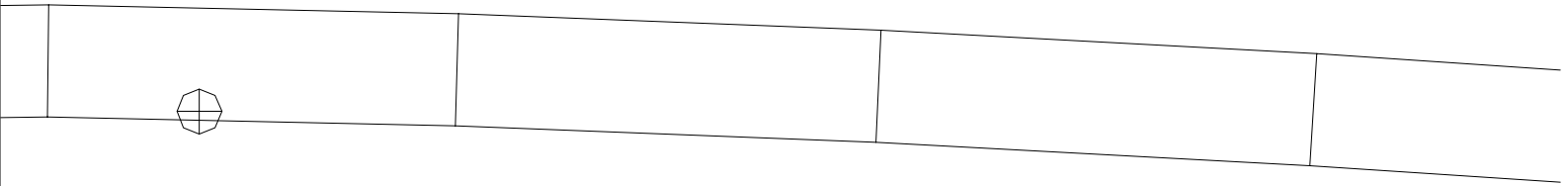



2-5



2-6



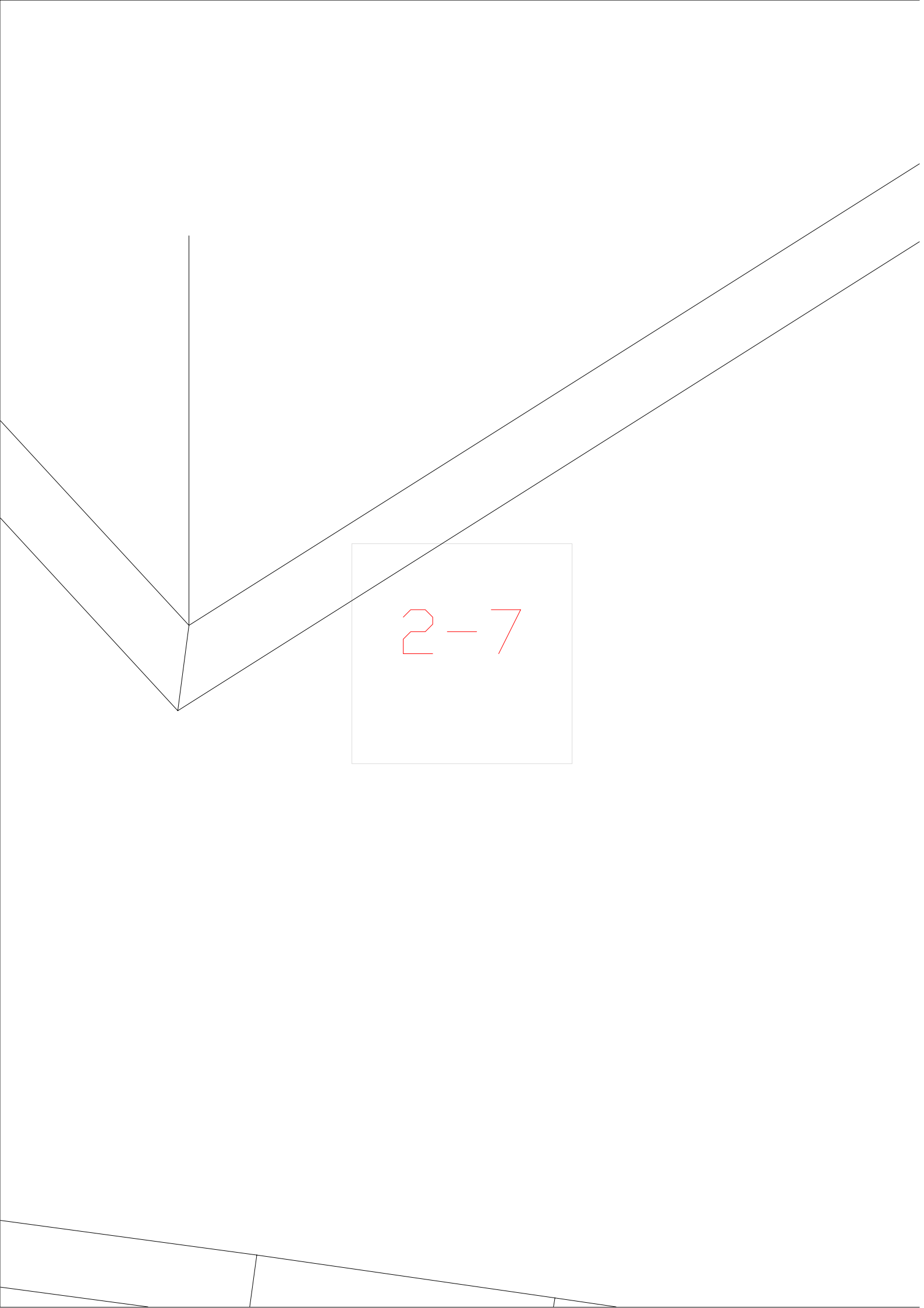

2-7

2-8



2-9

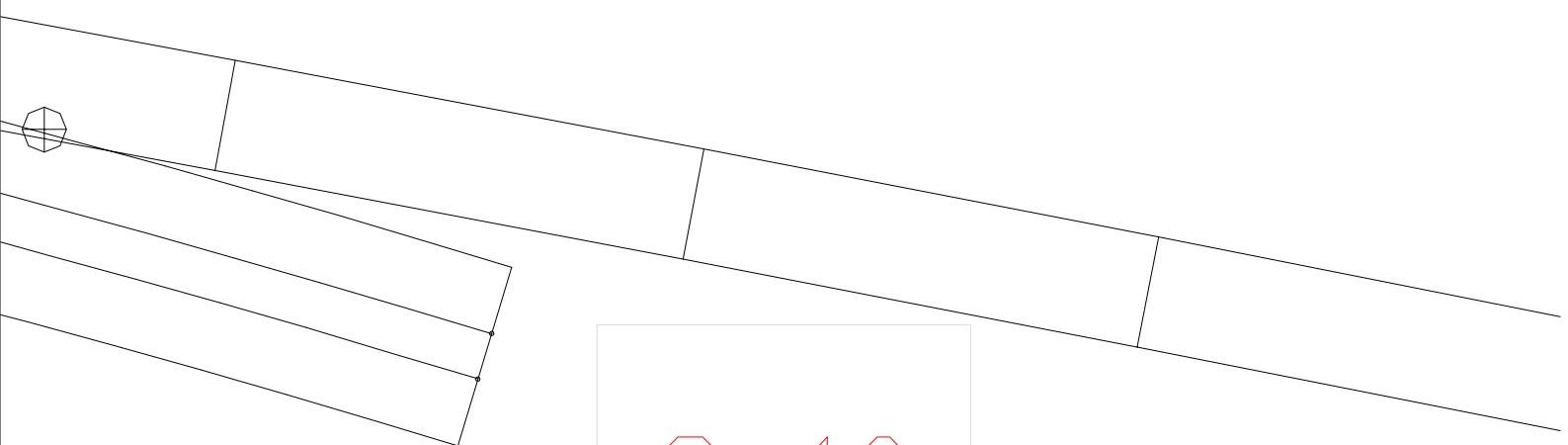

3-10

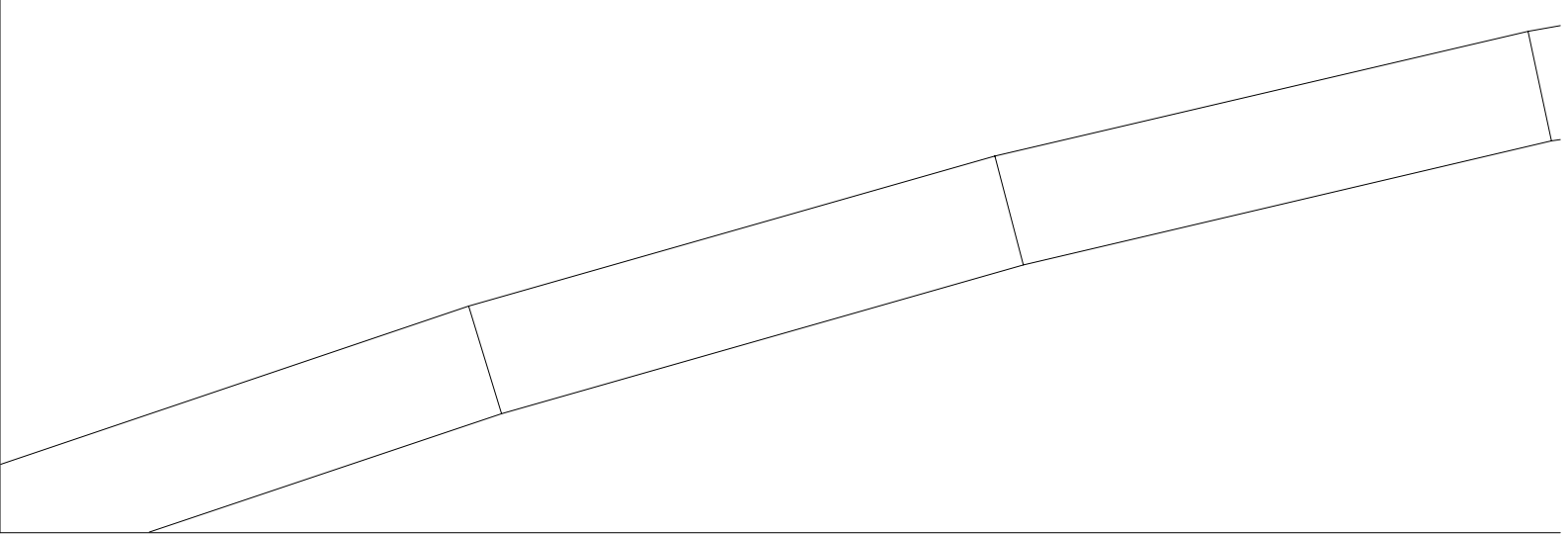

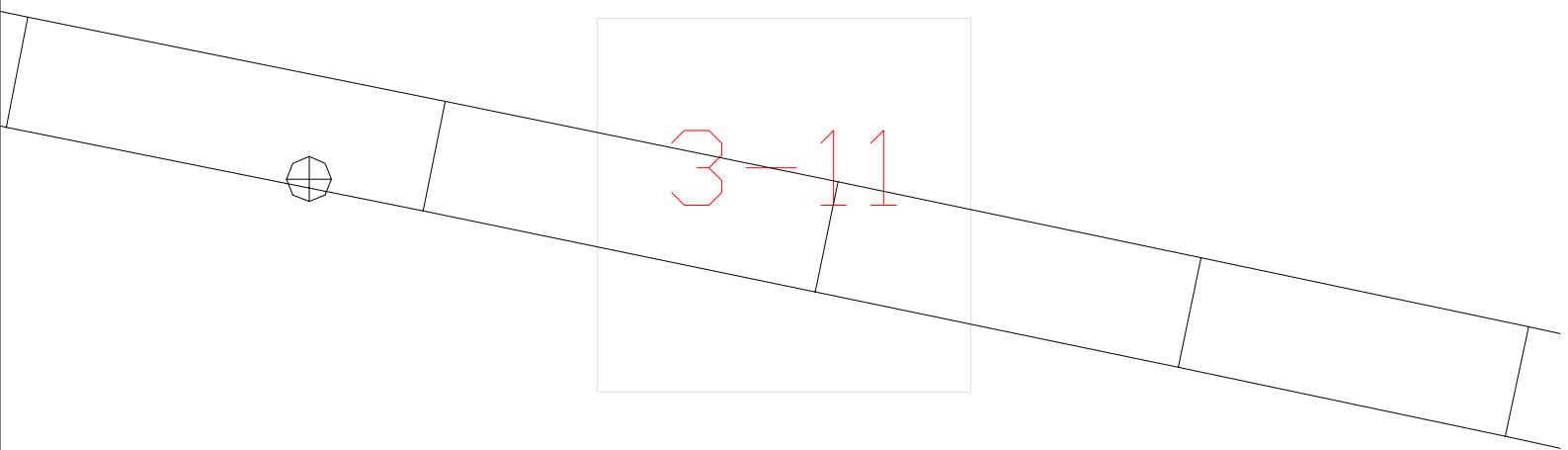

3-11

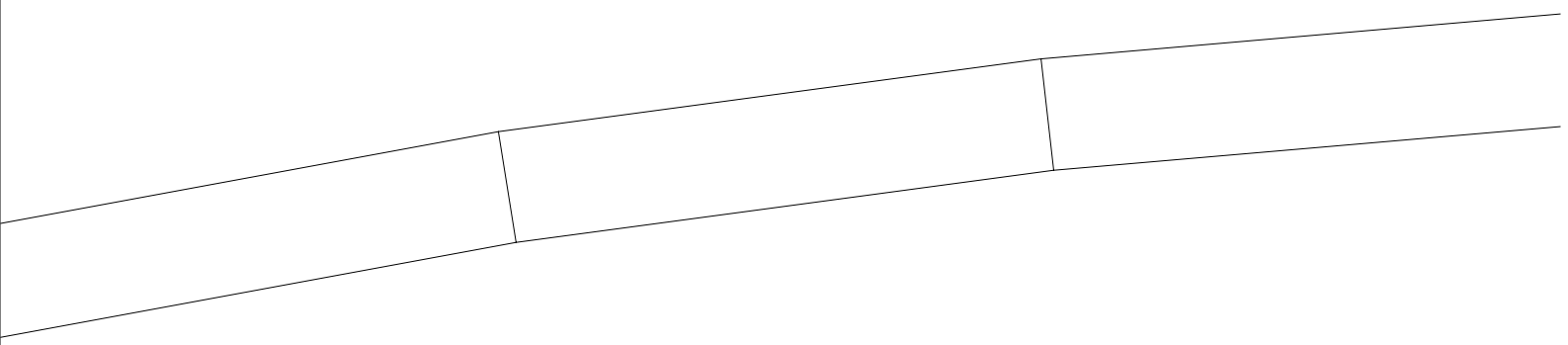

3-12

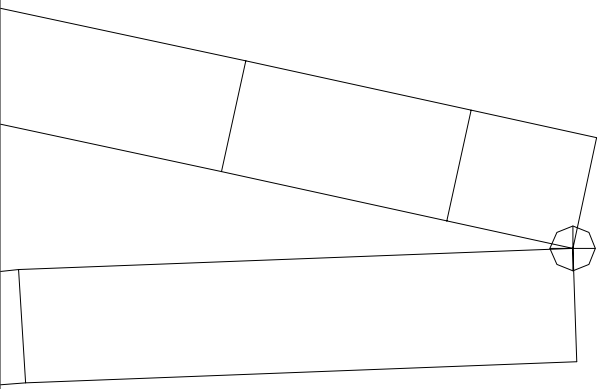

3-13

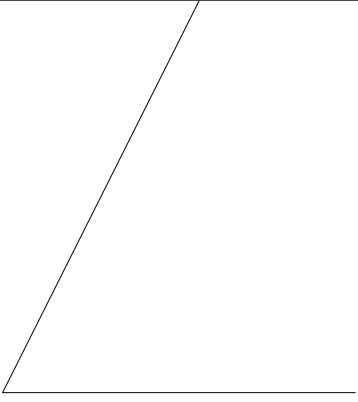

3-14

3-15

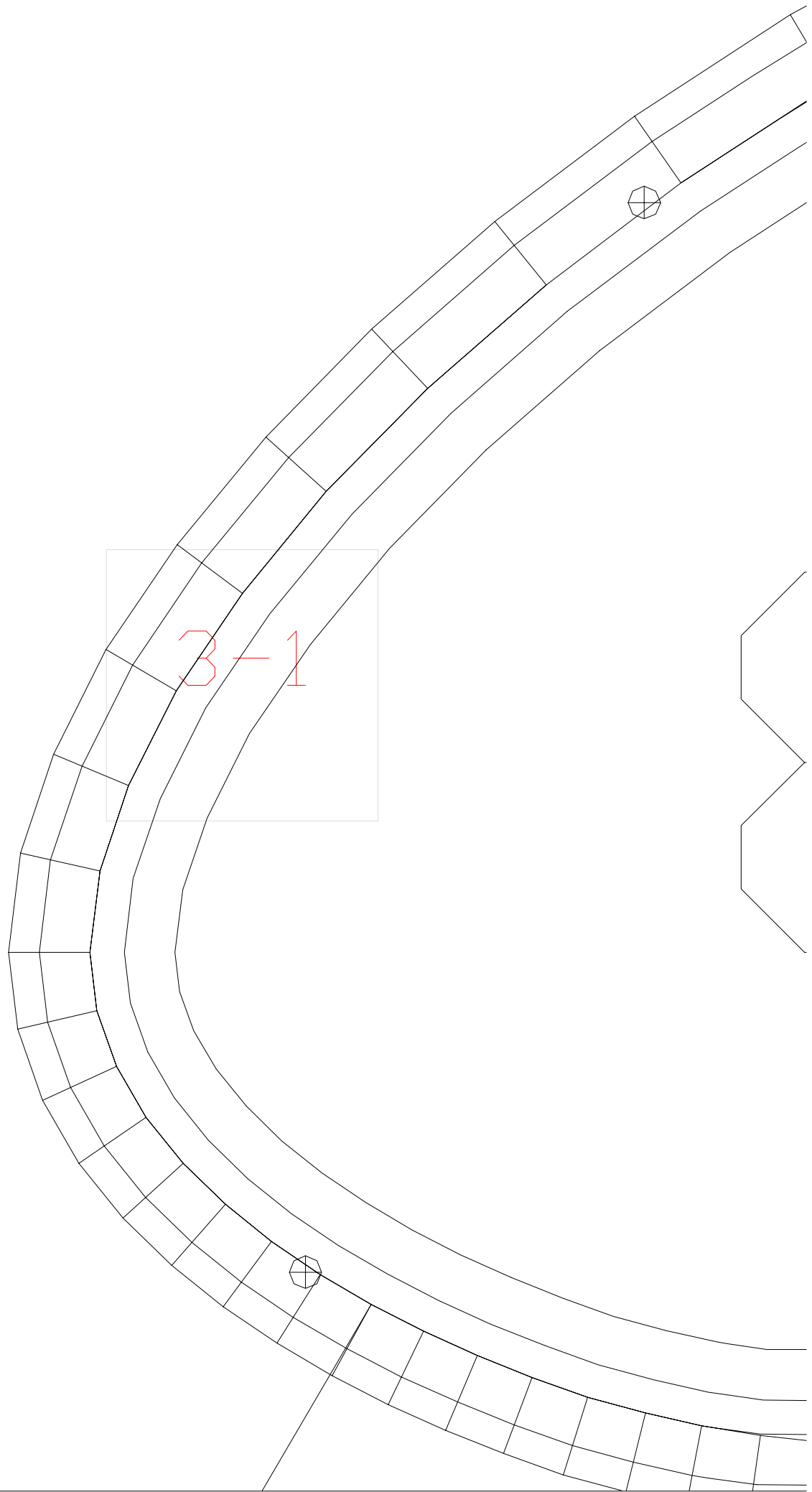

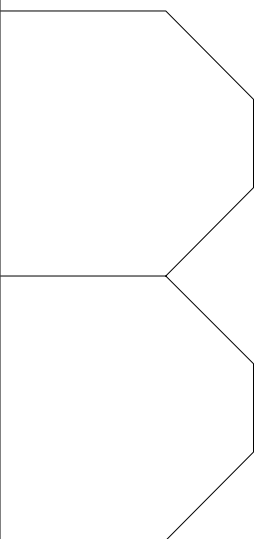
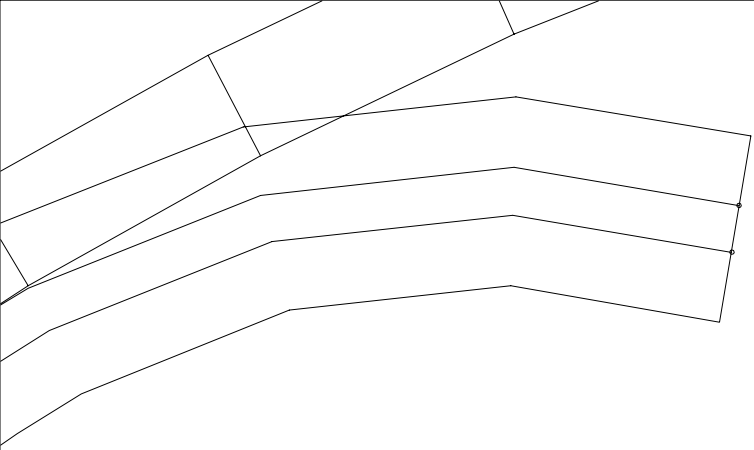

3-2

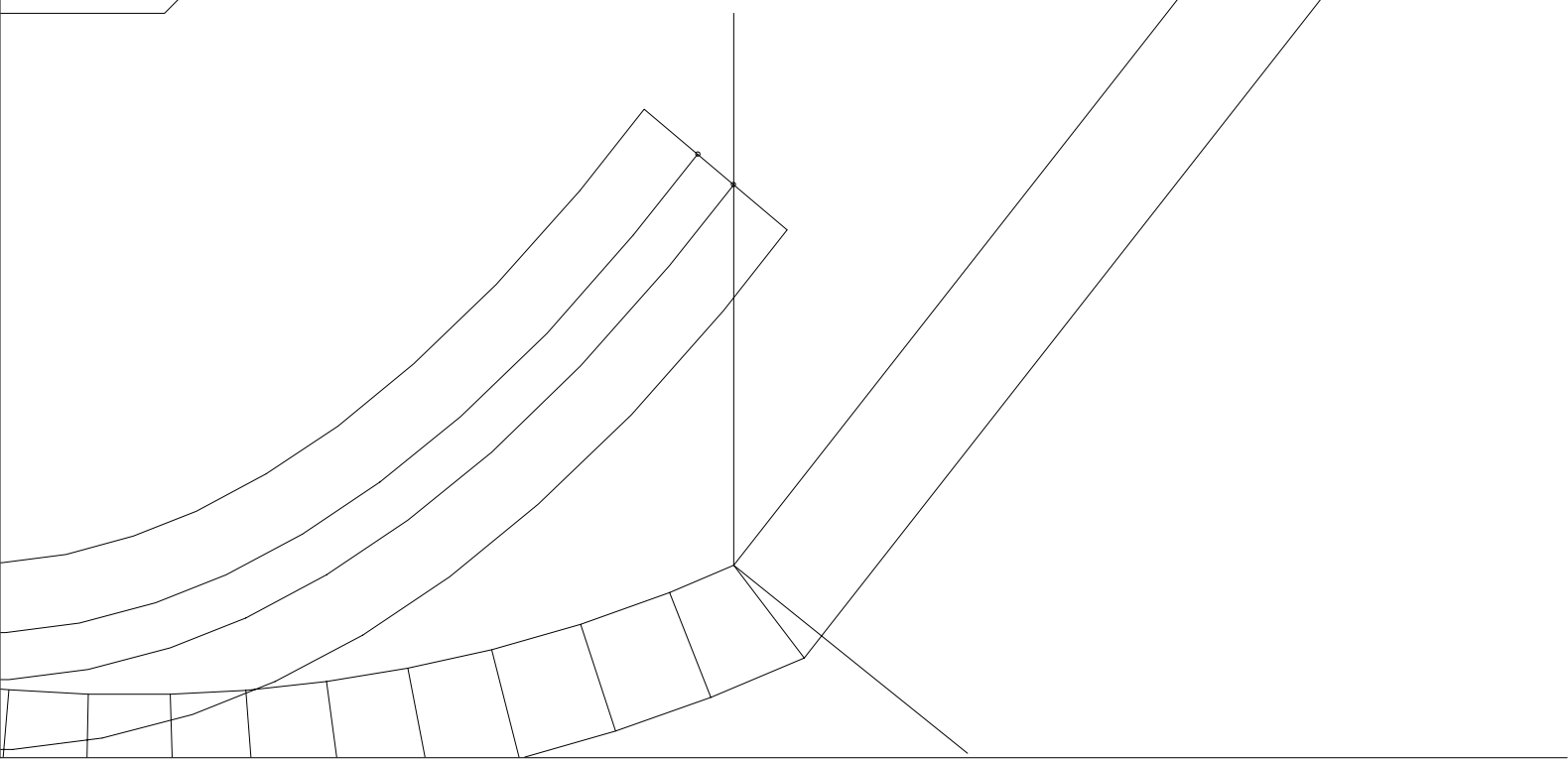

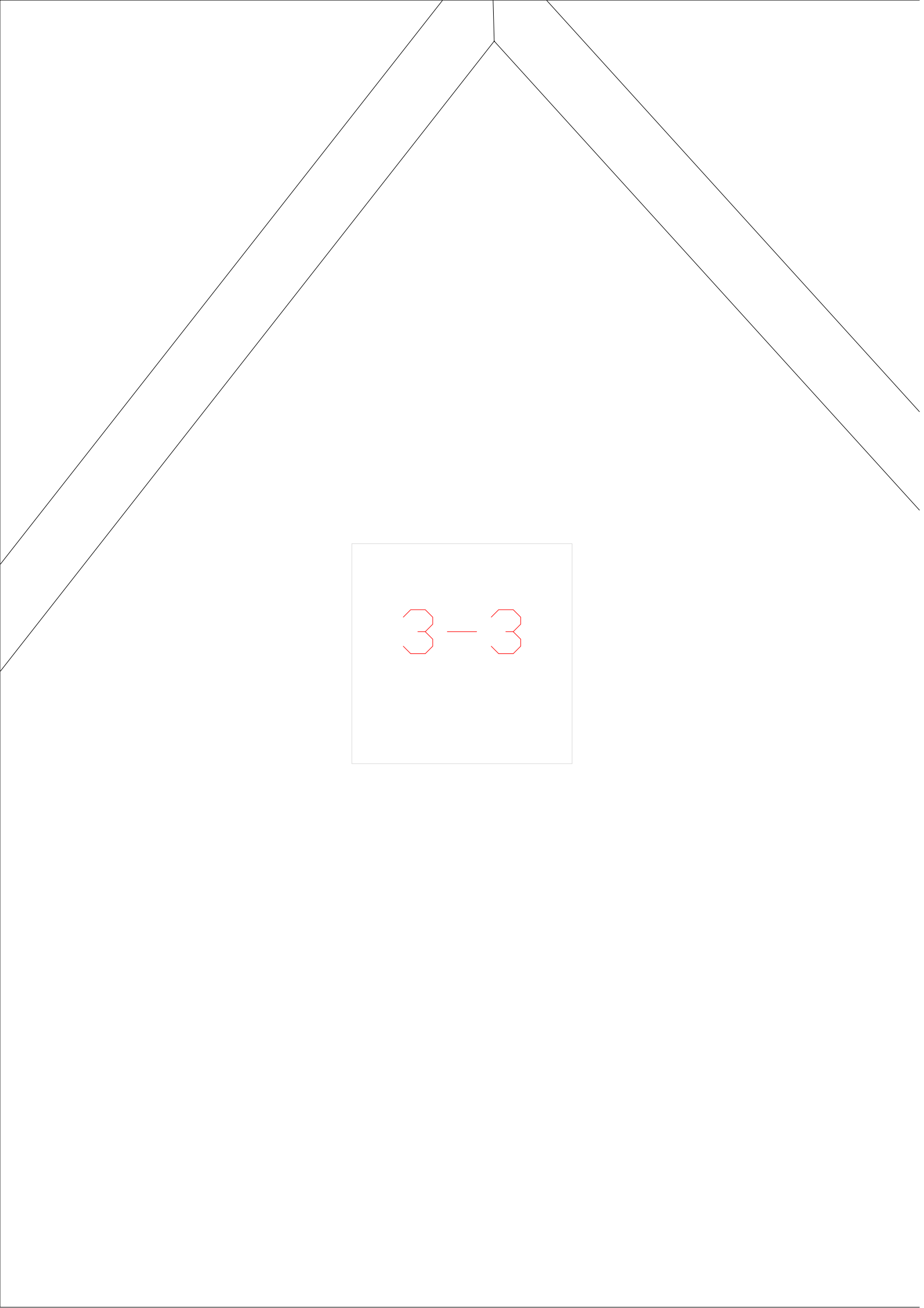

3-3

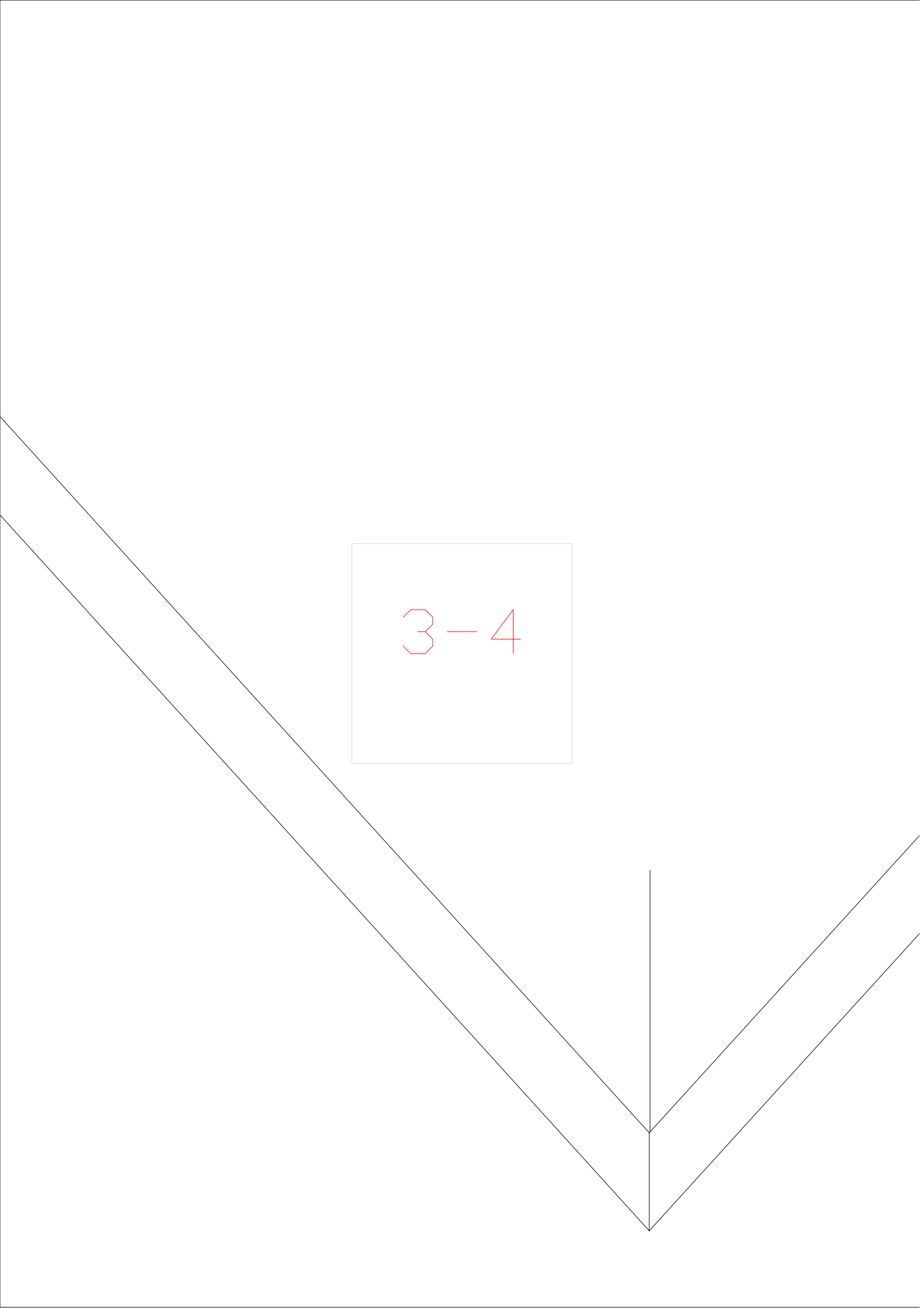

3-4

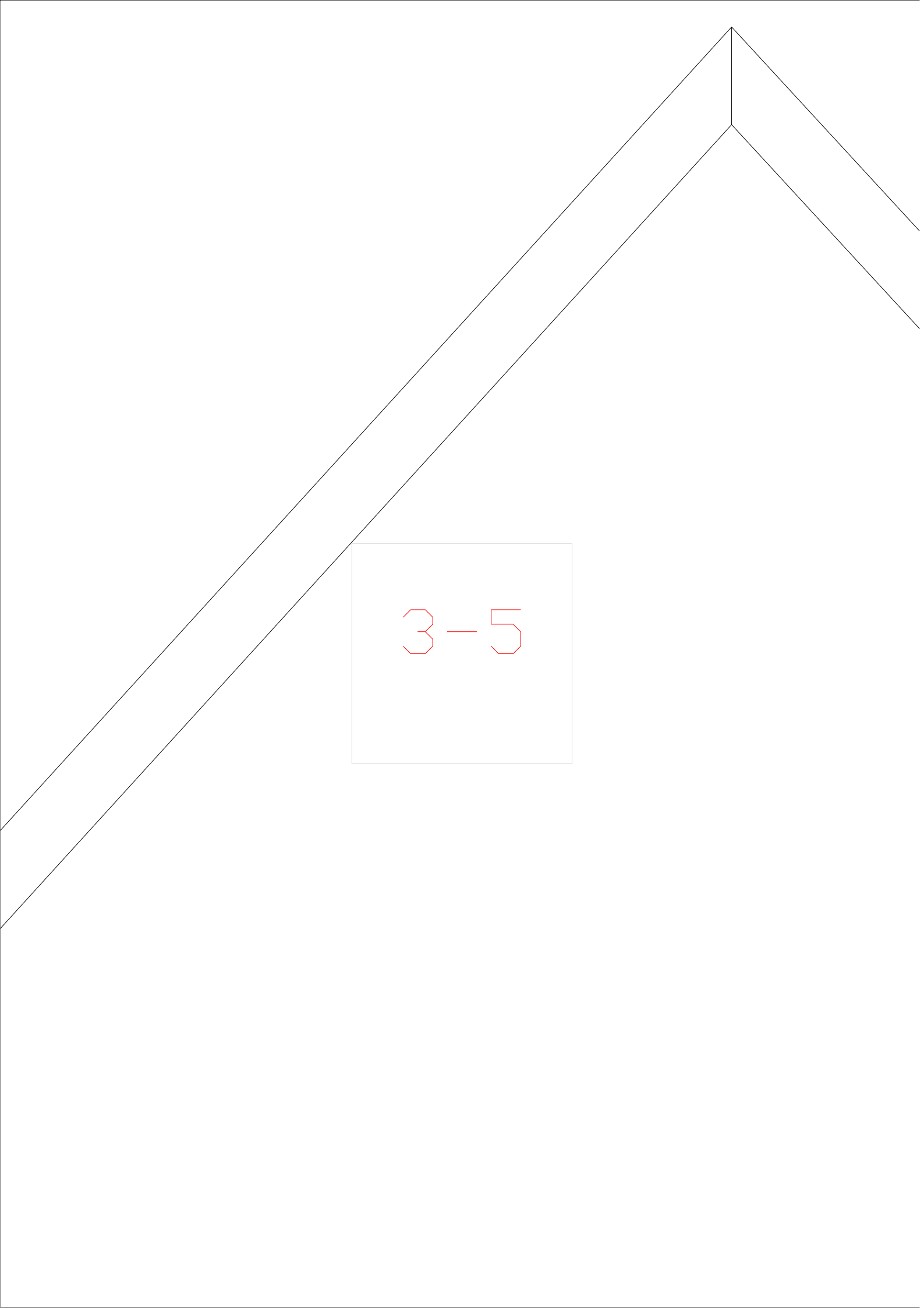

3-5



3-6



3-7

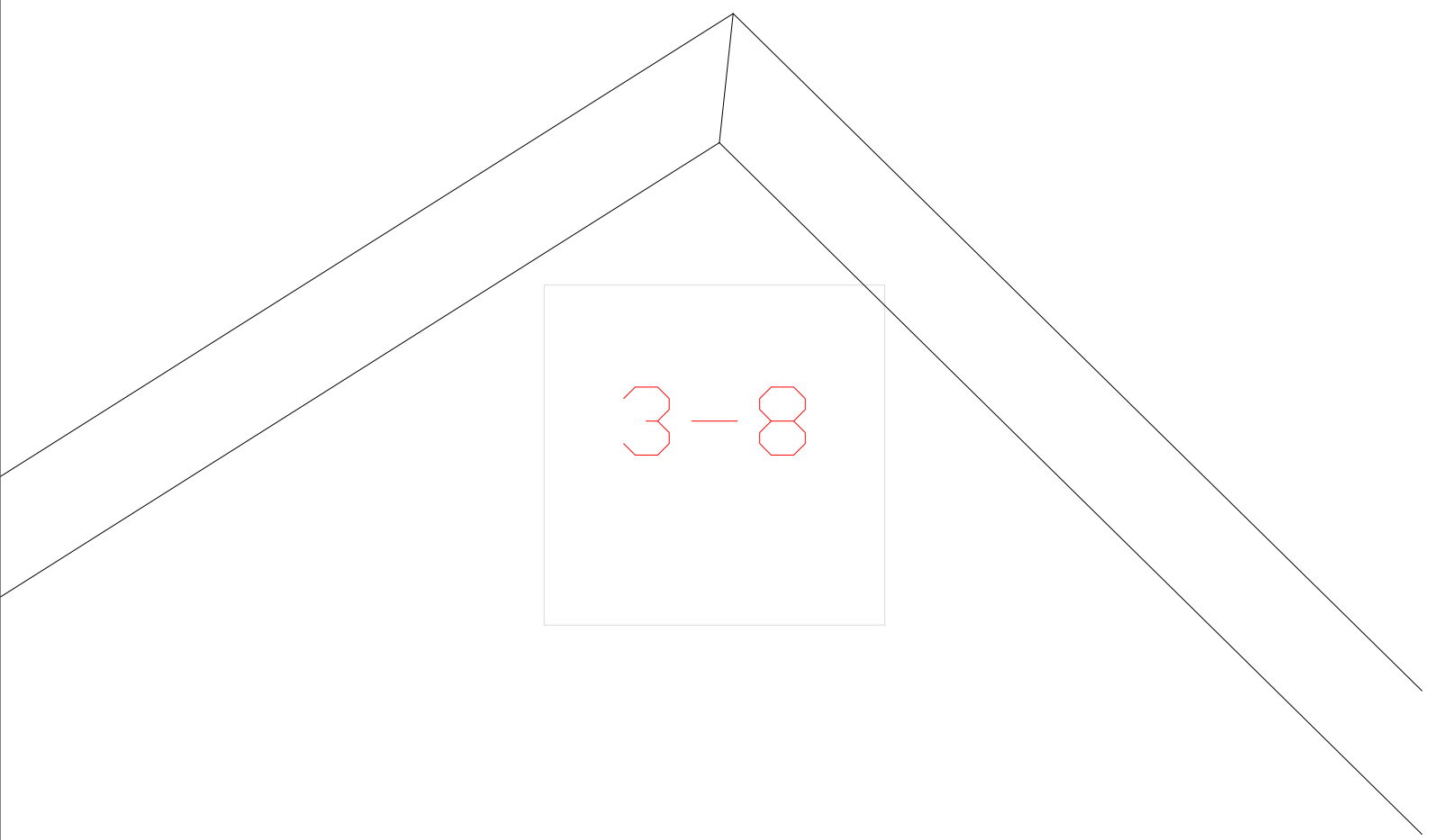
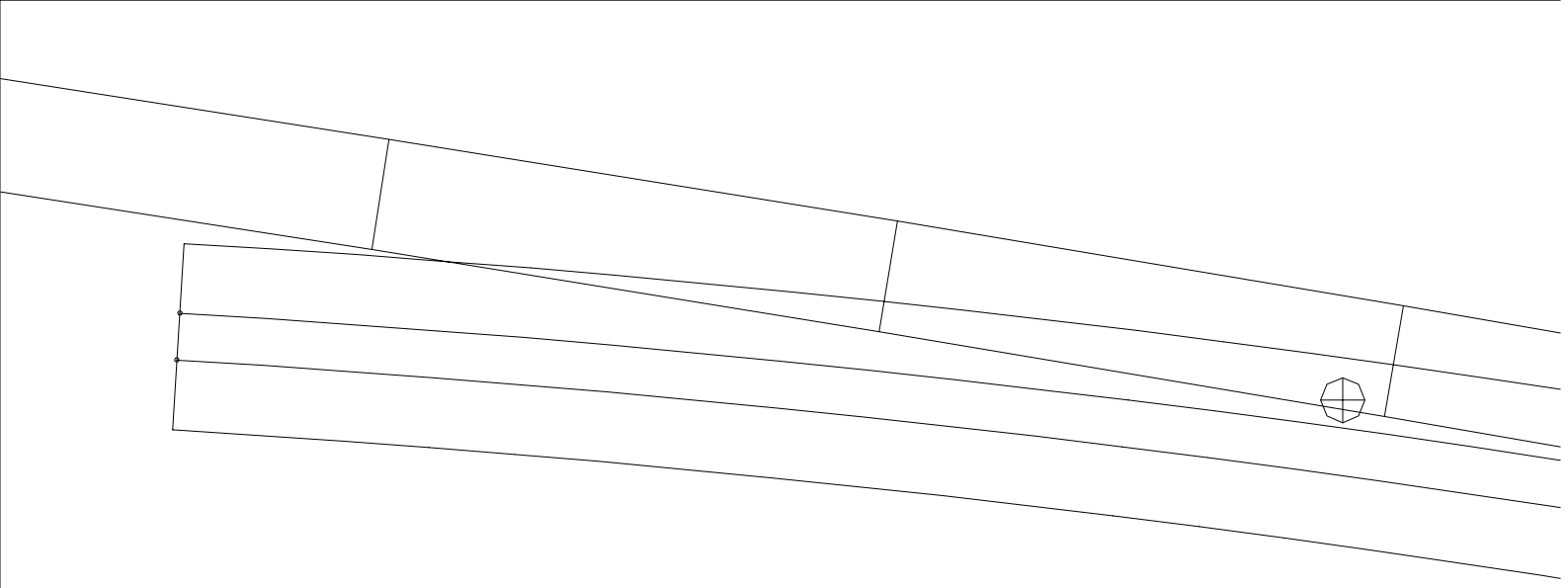

3-8

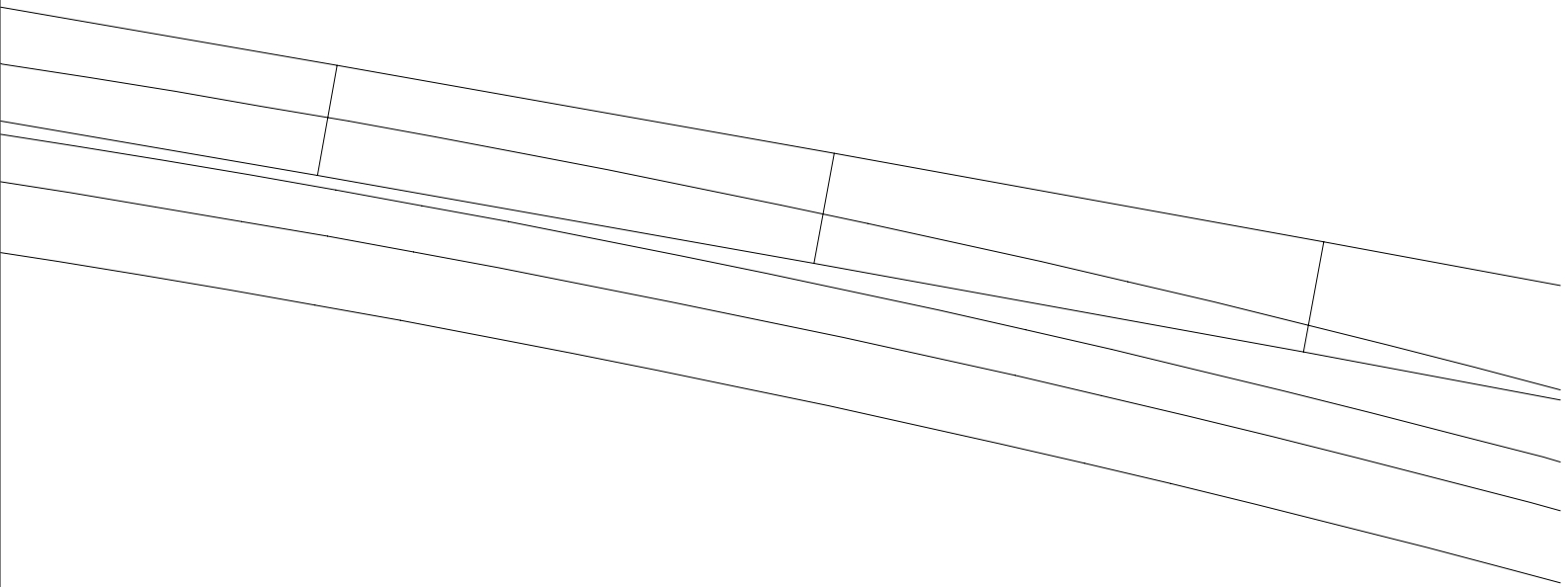

3-9

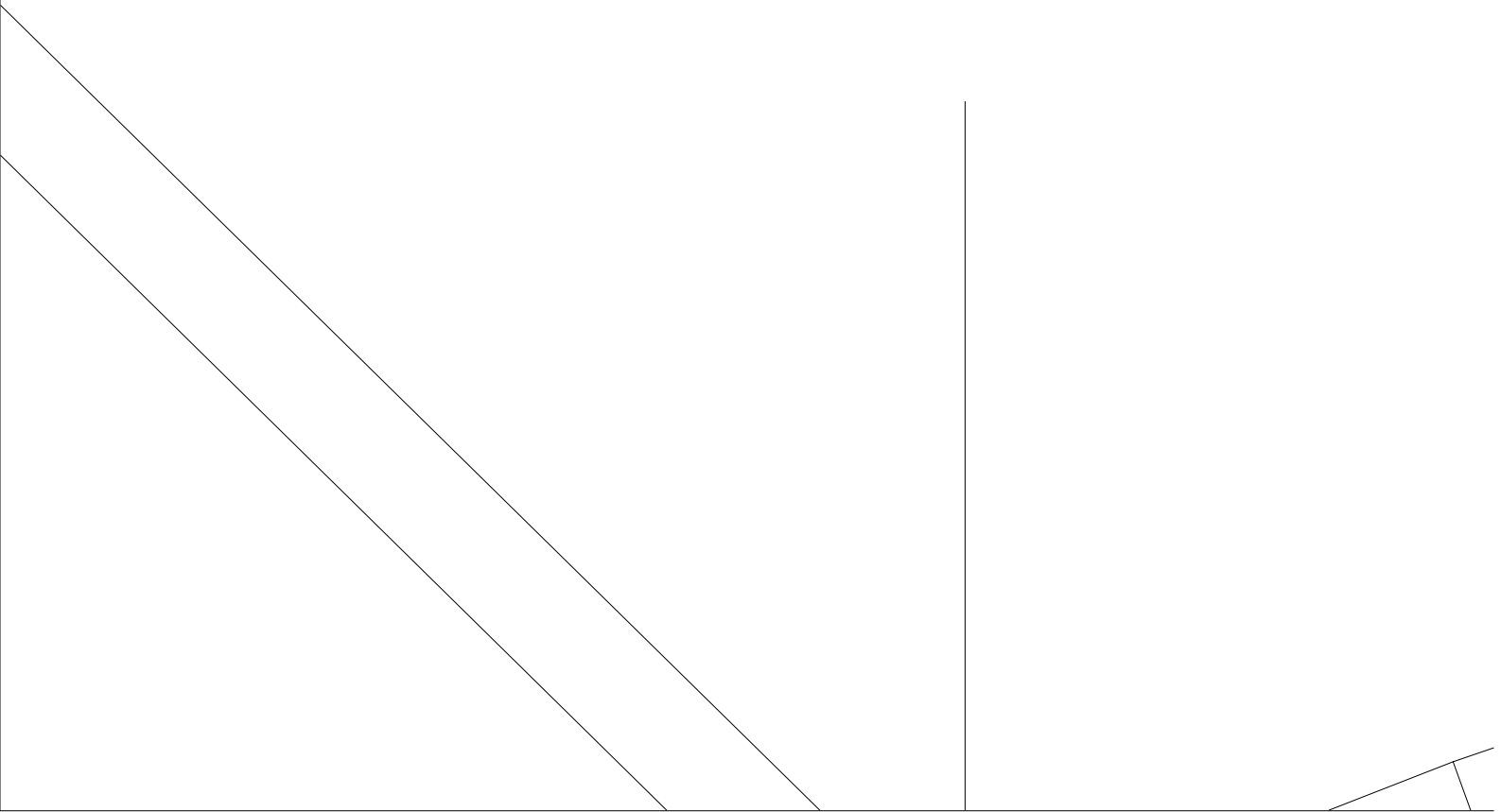

4-10

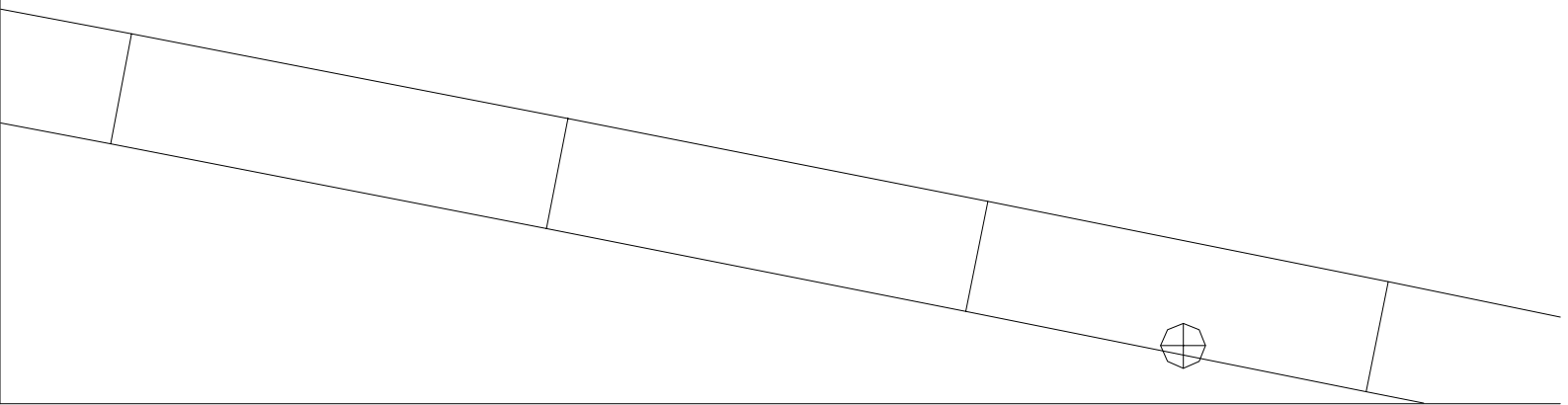
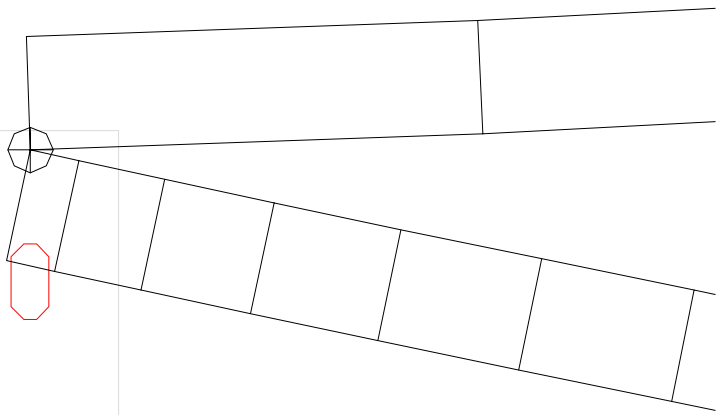

4-11

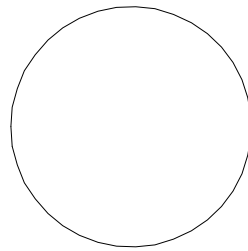

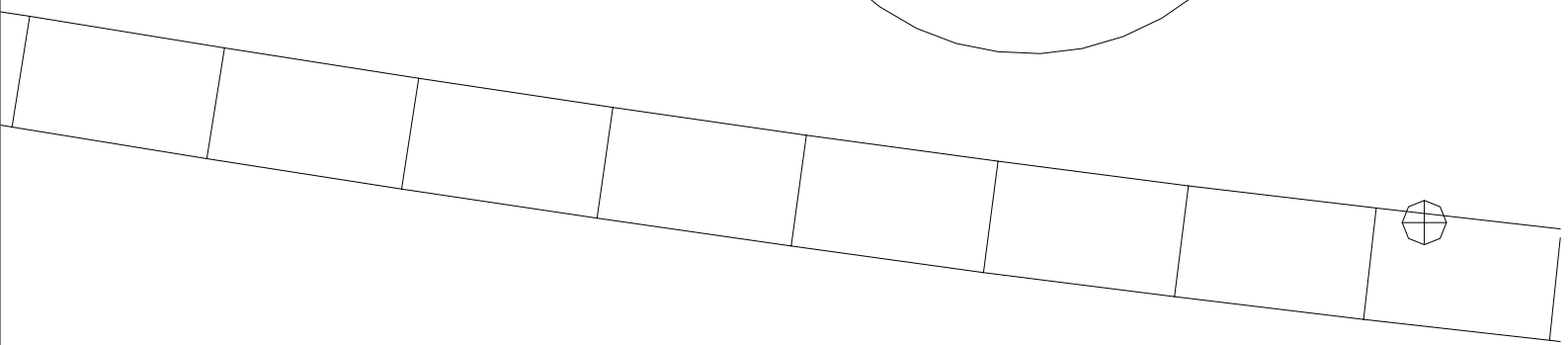
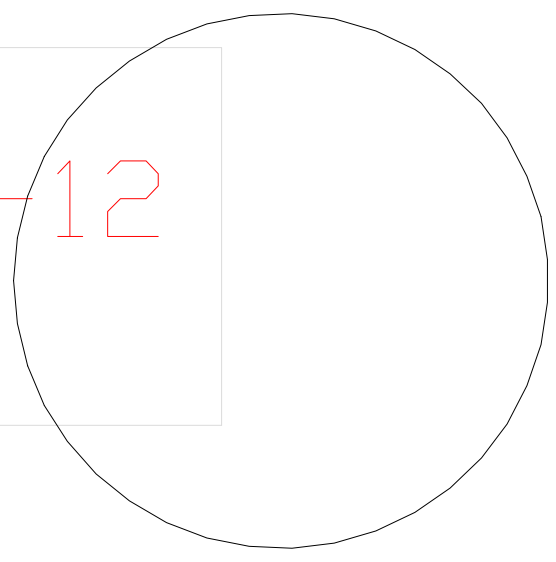
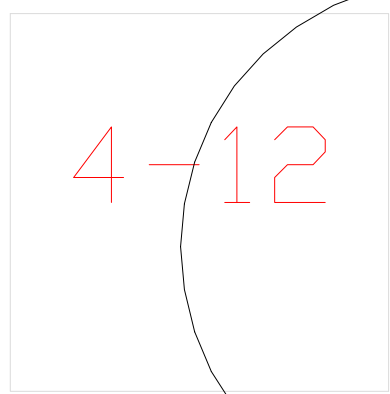
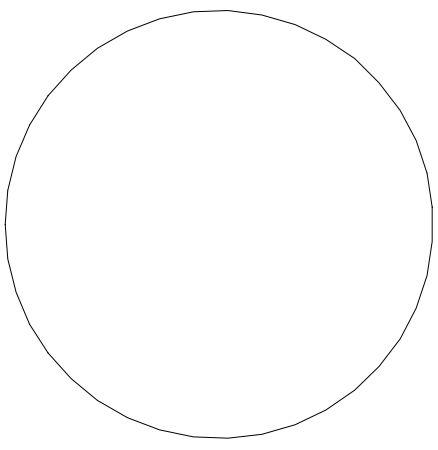
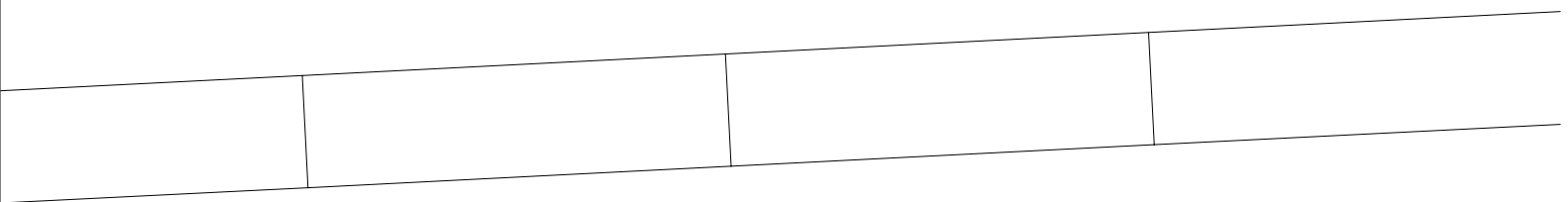

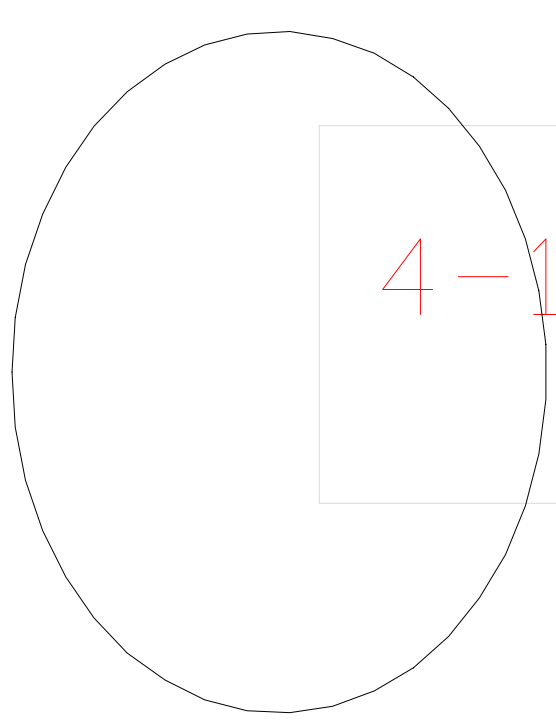
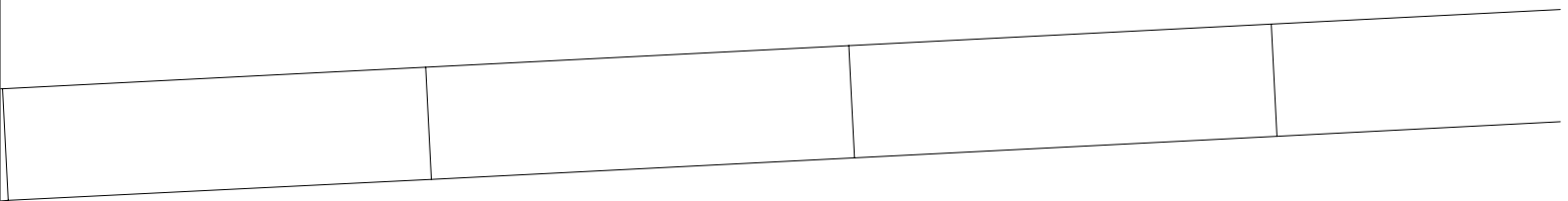

4-13

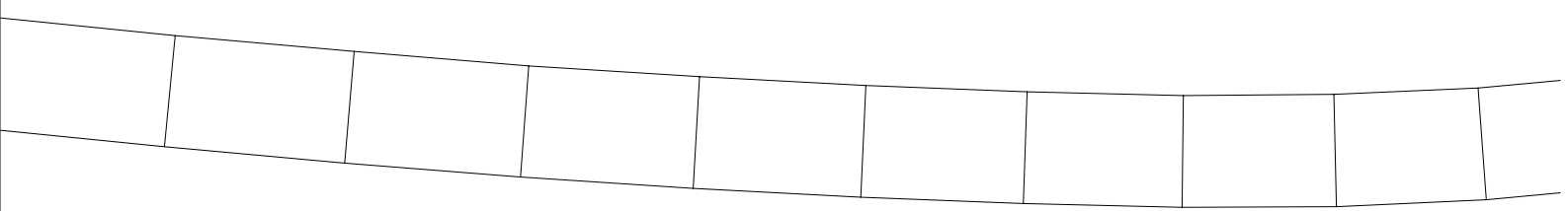
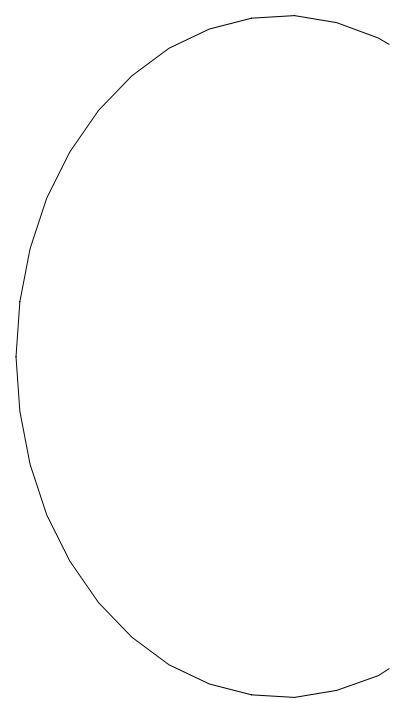

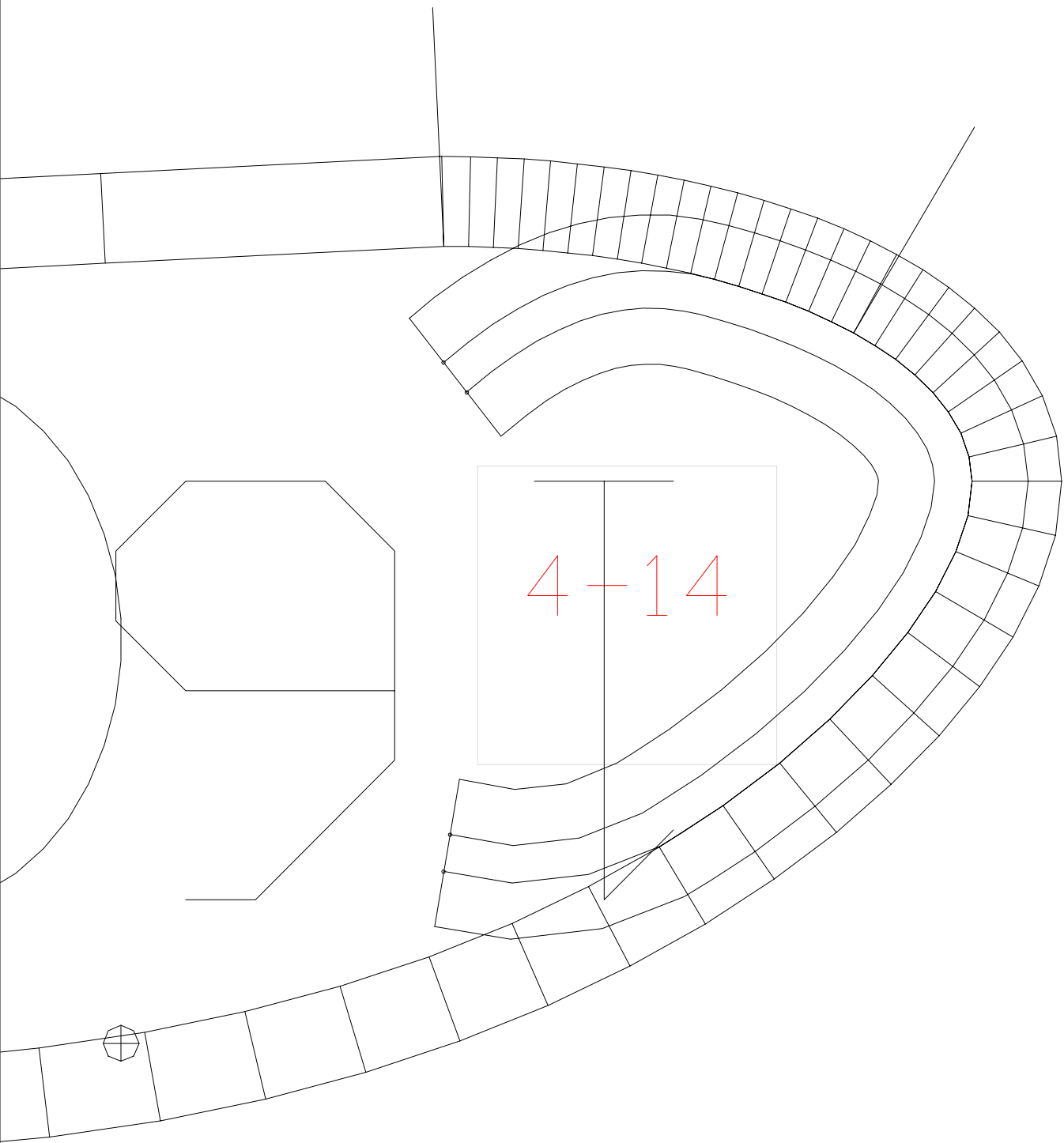

4-15

4-1

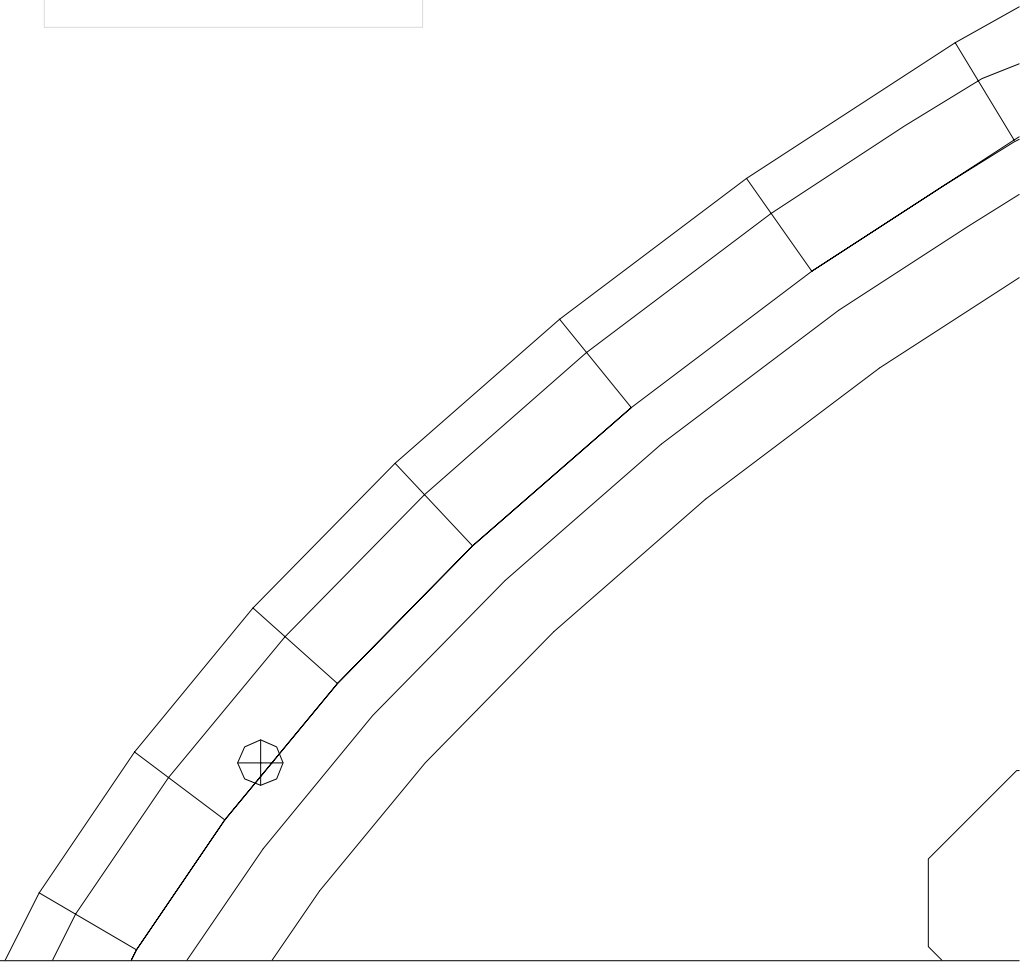

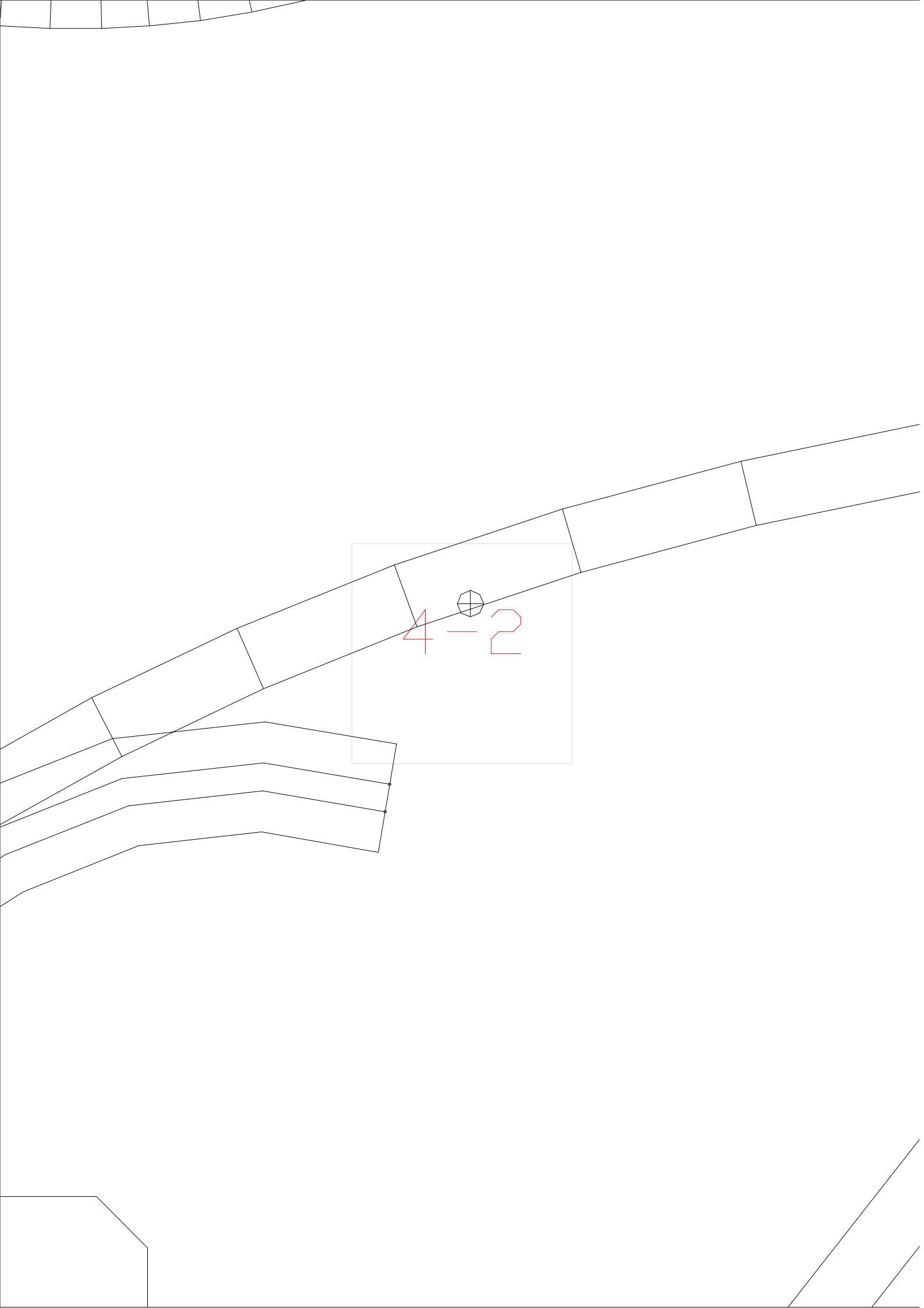

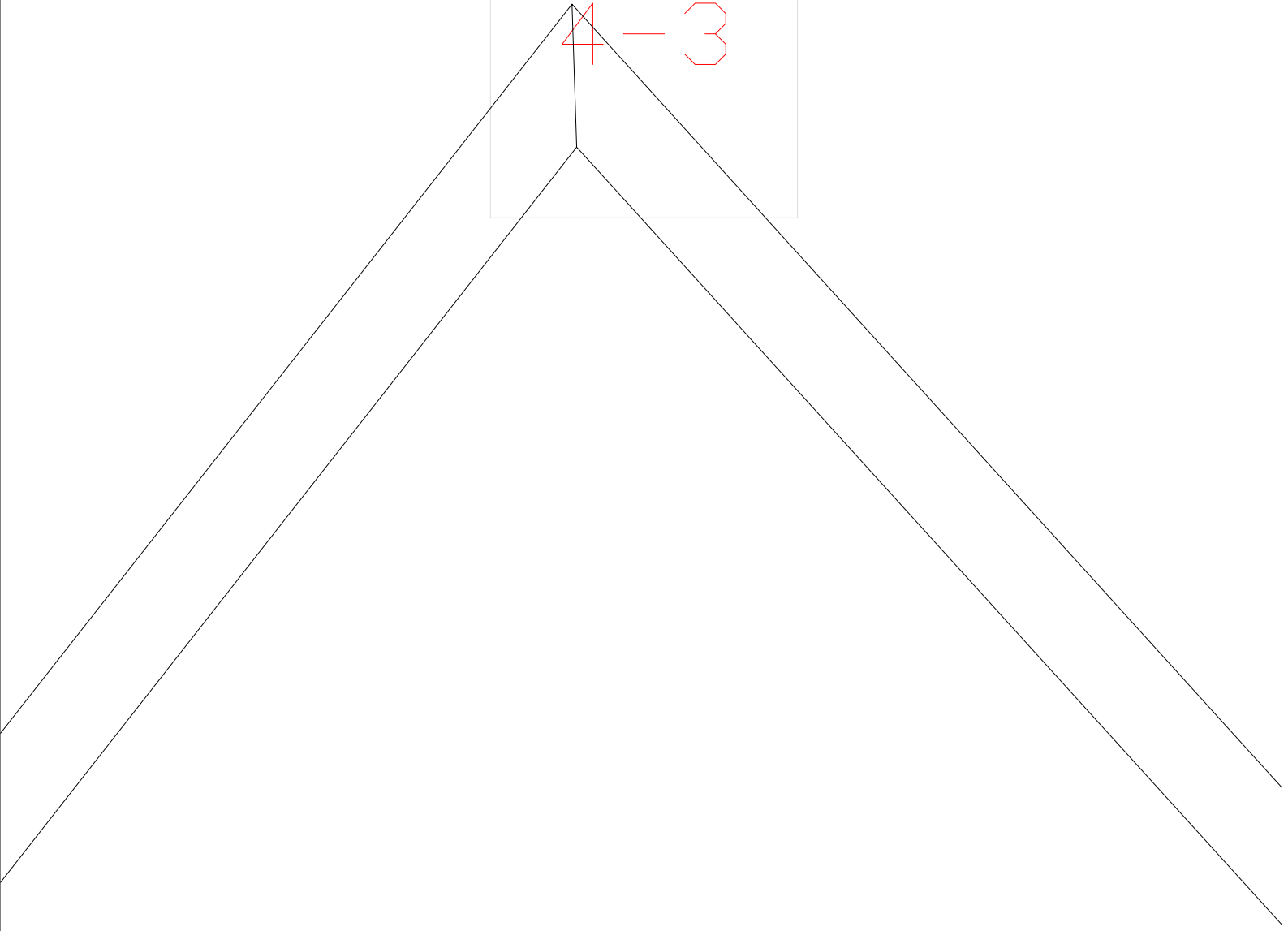
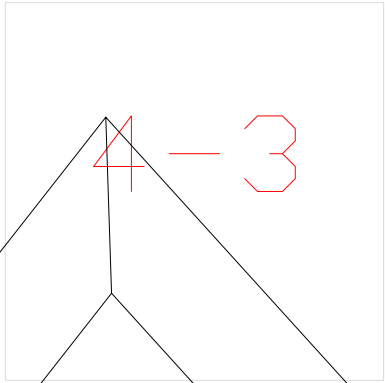
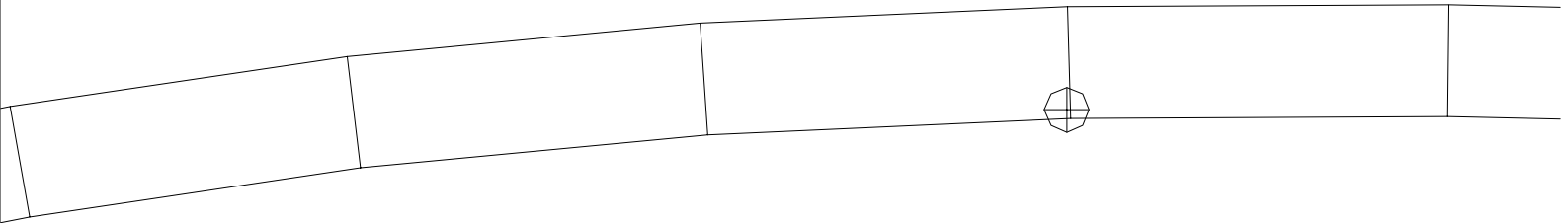

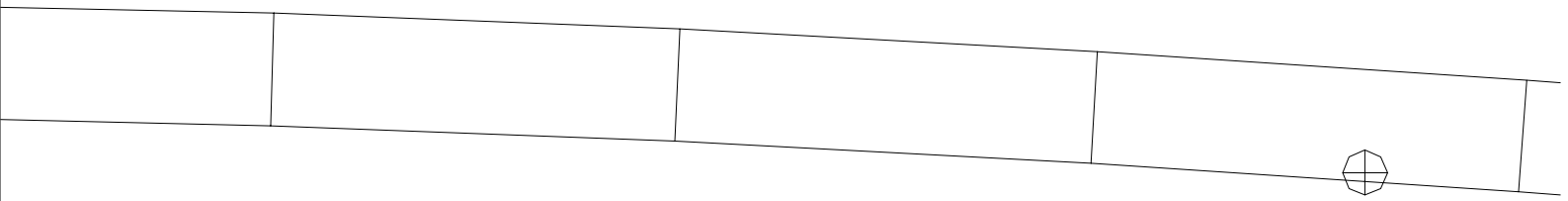

$$4 - 4$$

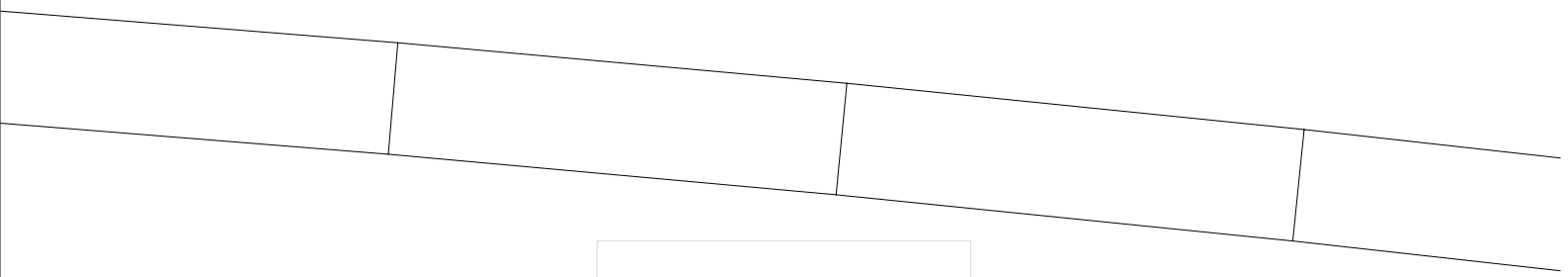

4-5

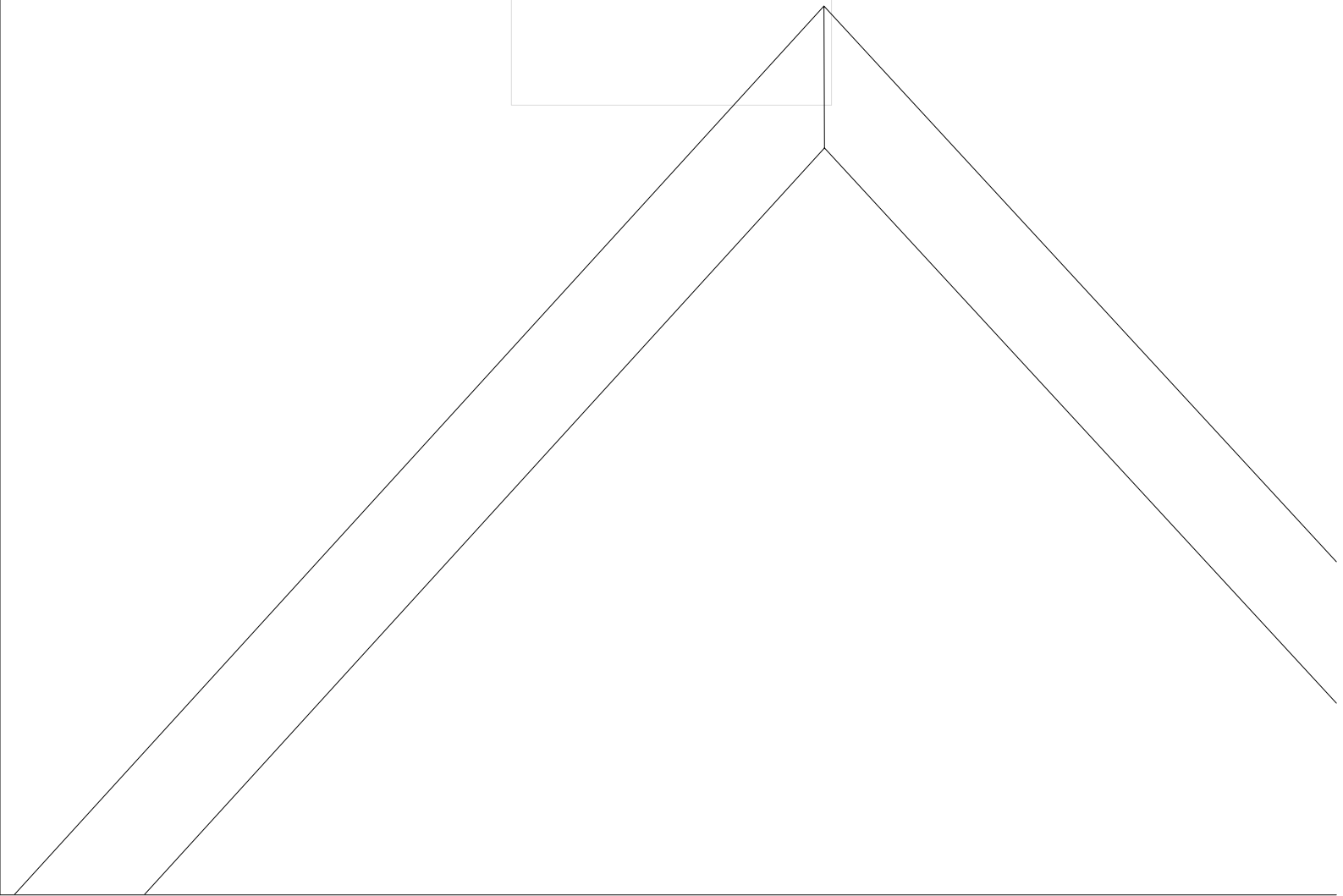

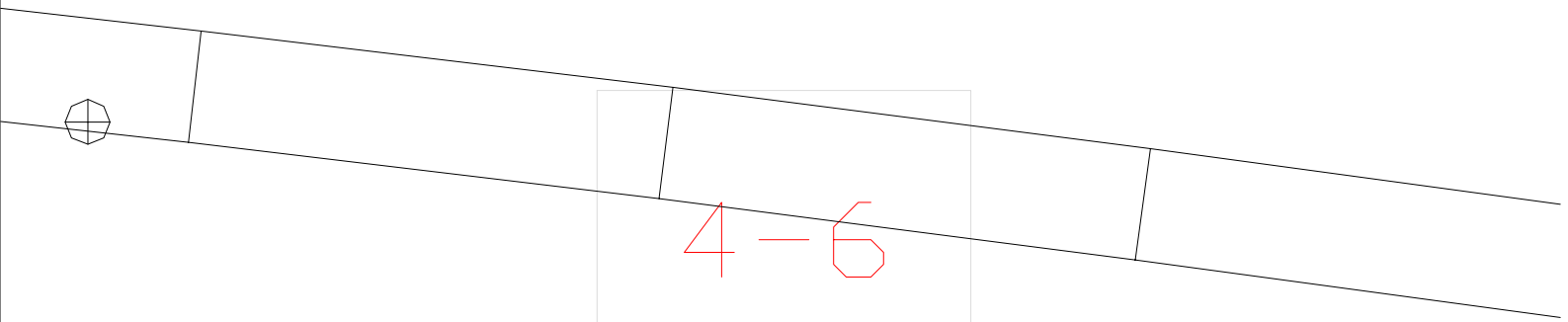

4-6

4-7



4-8





4-9



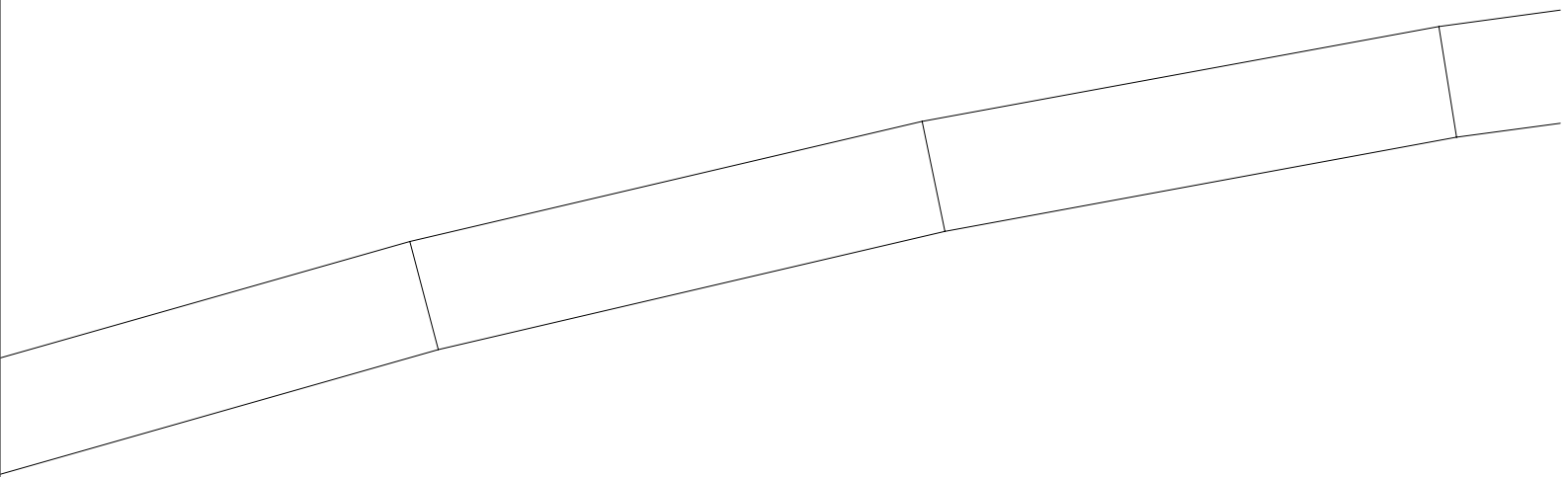

5-10

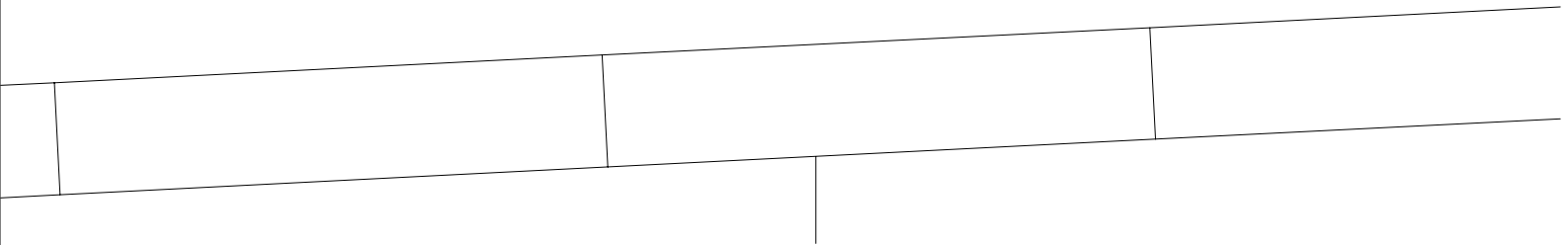

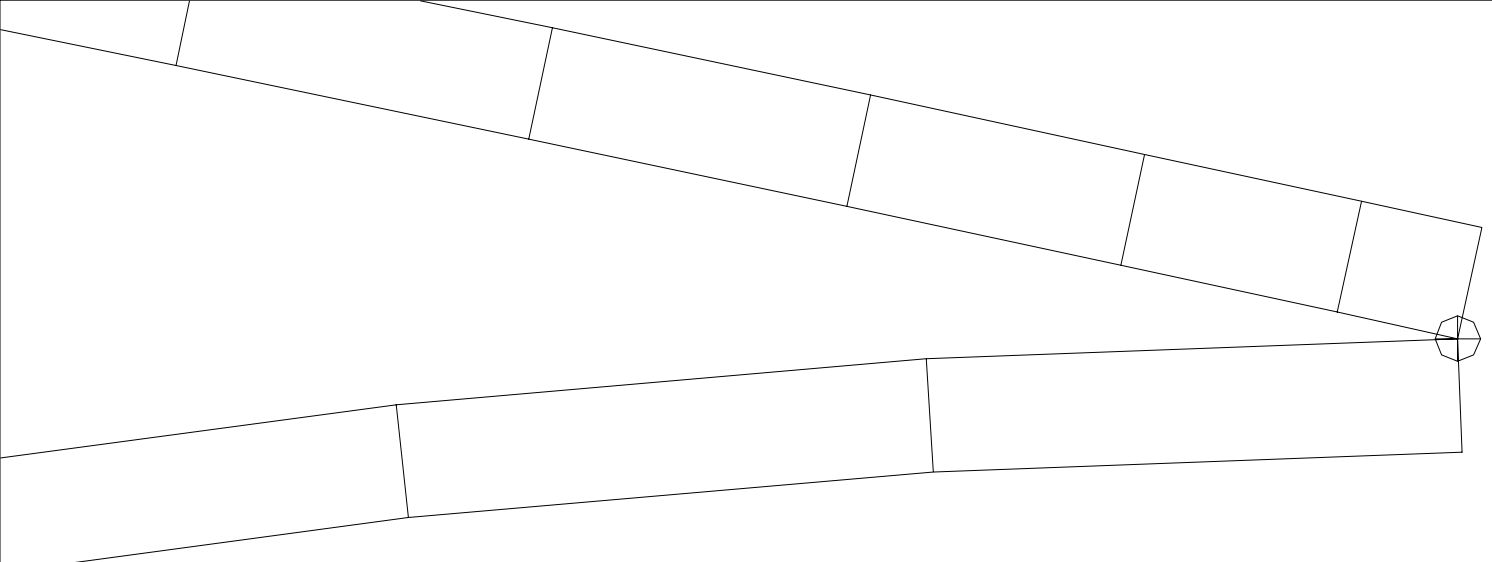

5-11

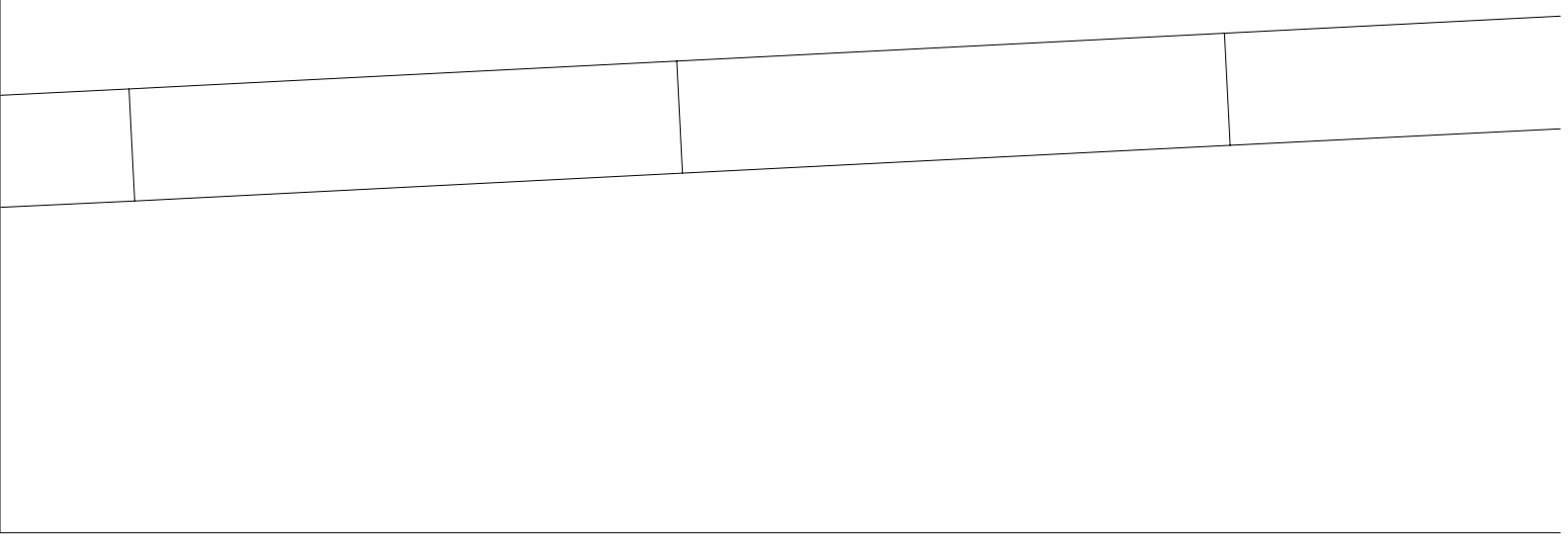

5-12

5-13

--	--	--	--

5-14

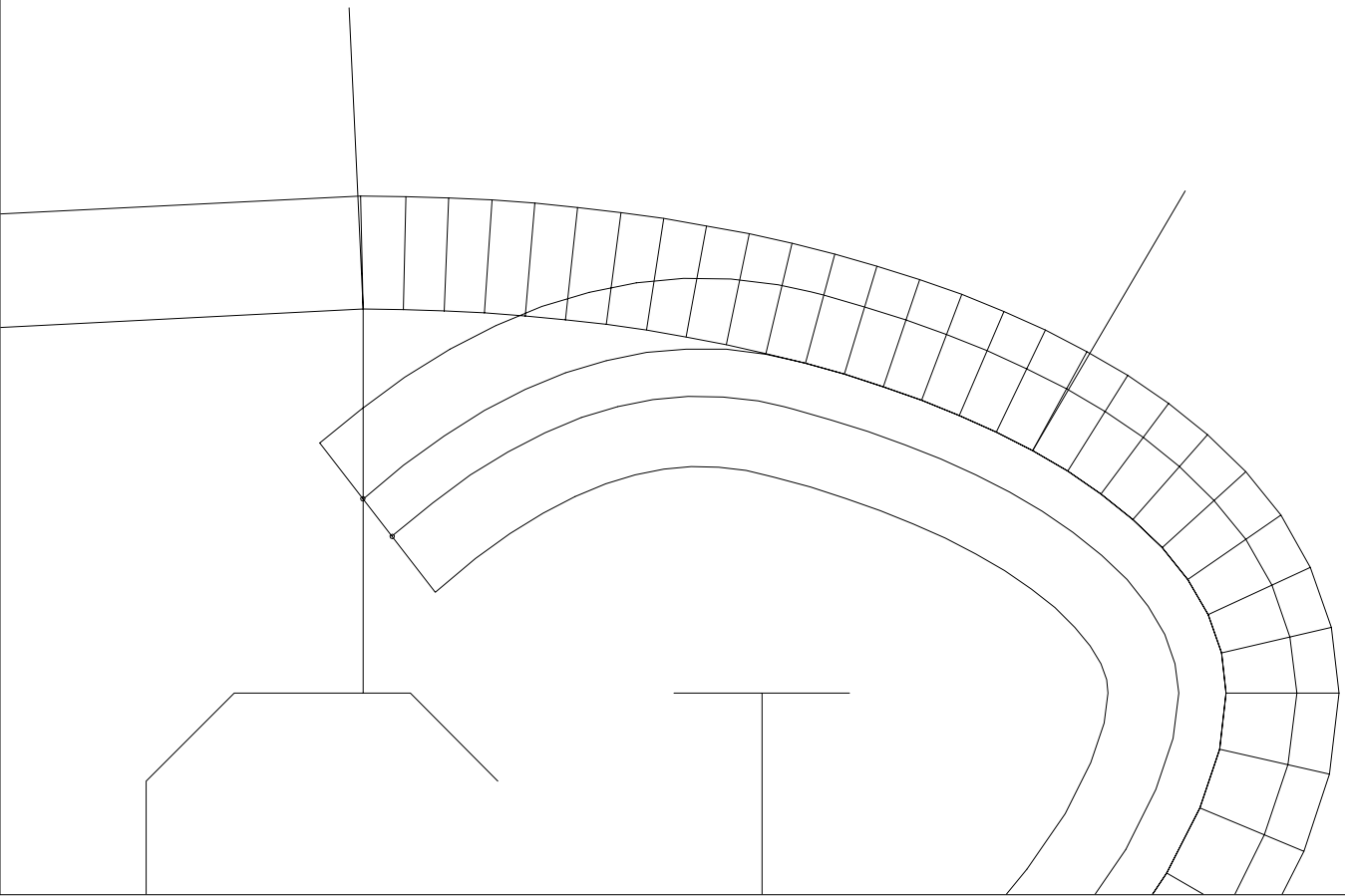

5-15

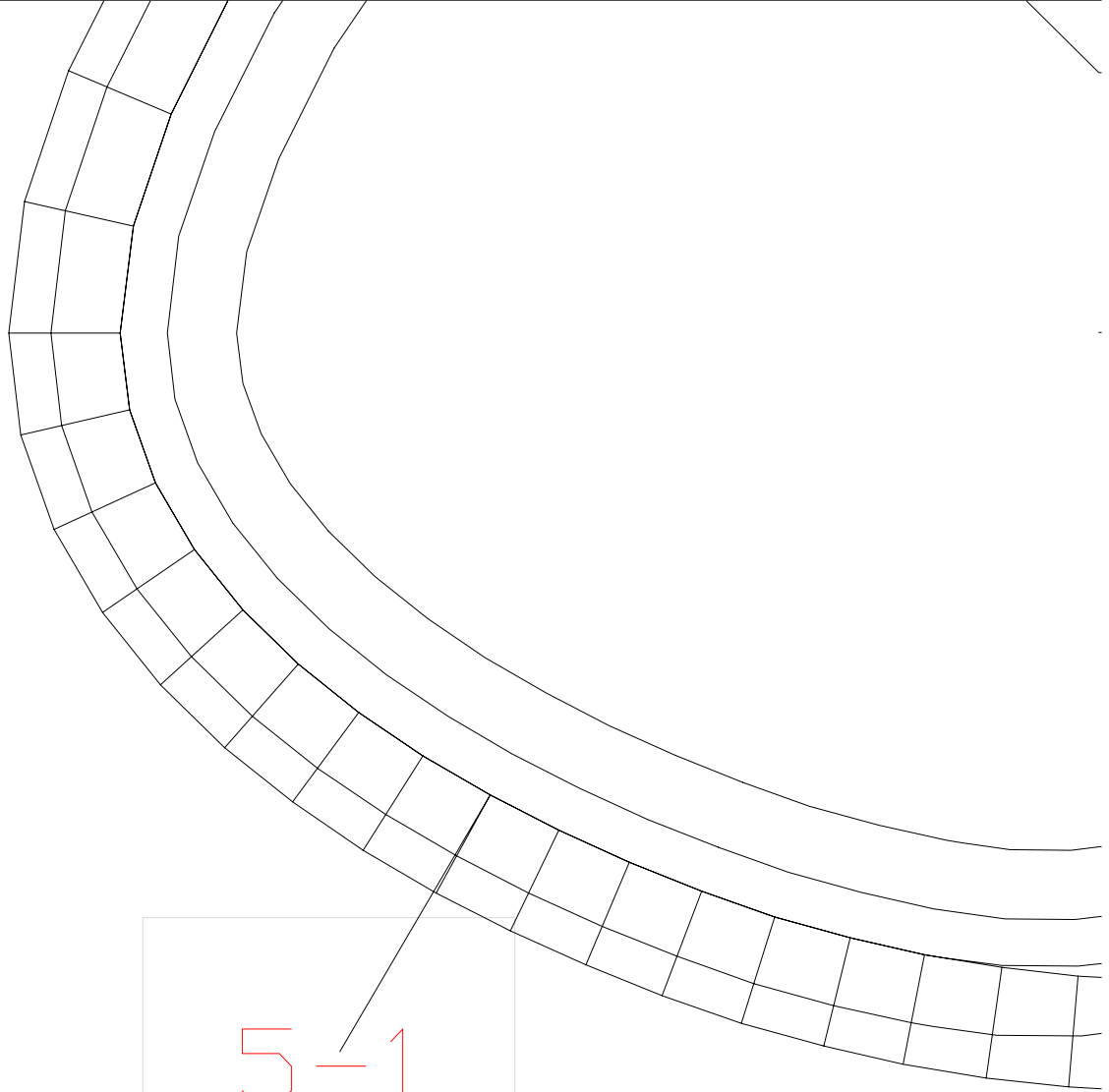

5-1

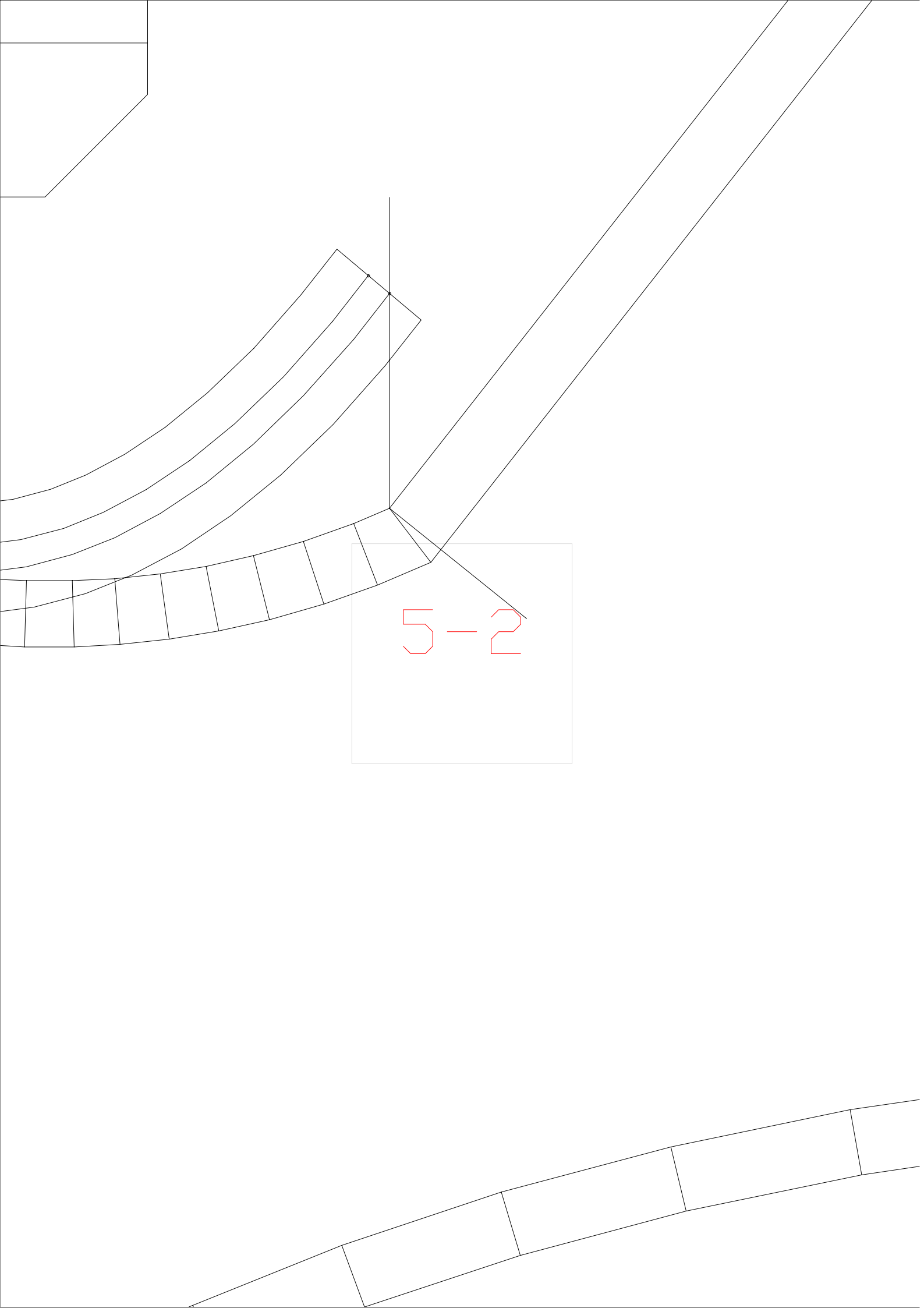

5-2

5-3



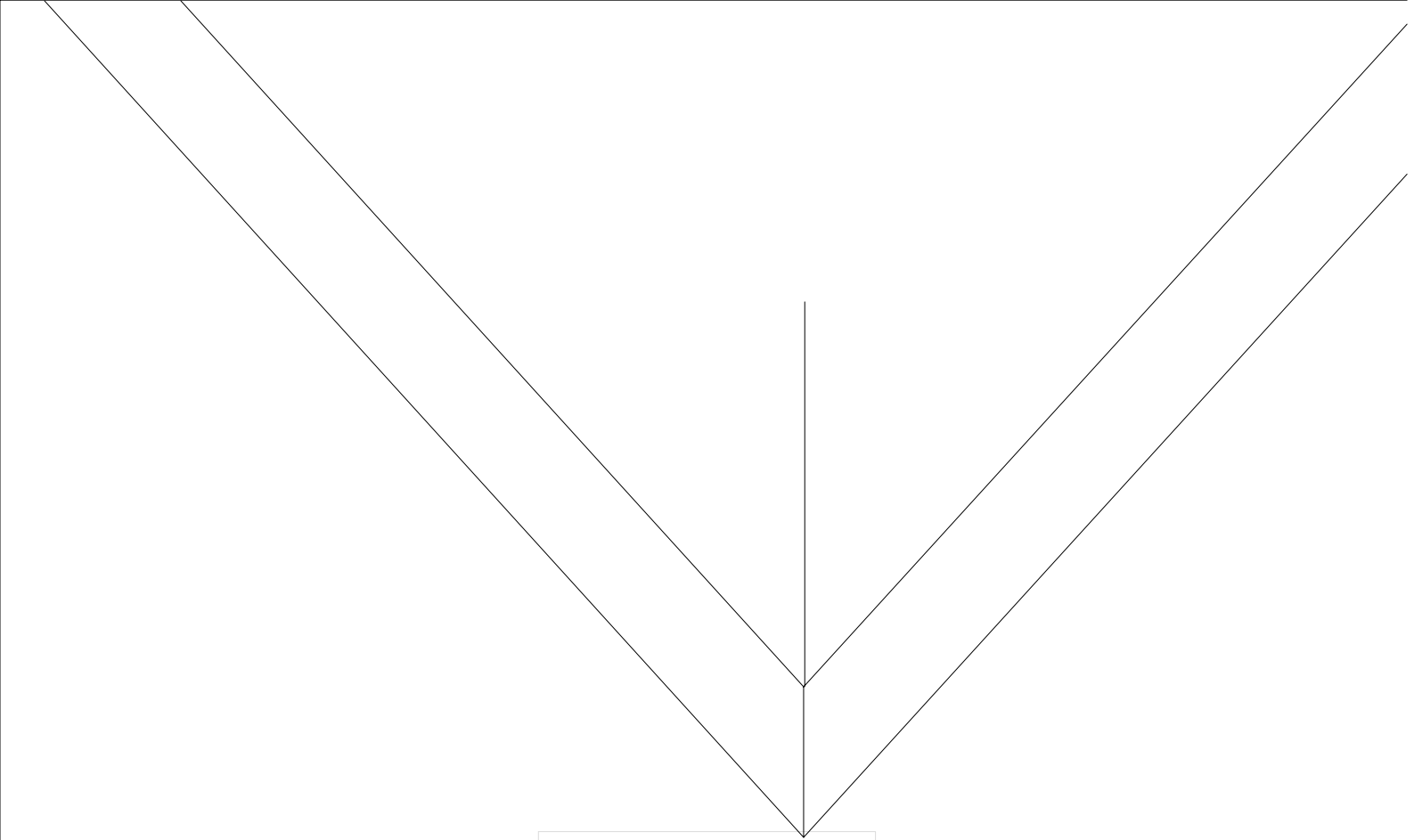

5-4

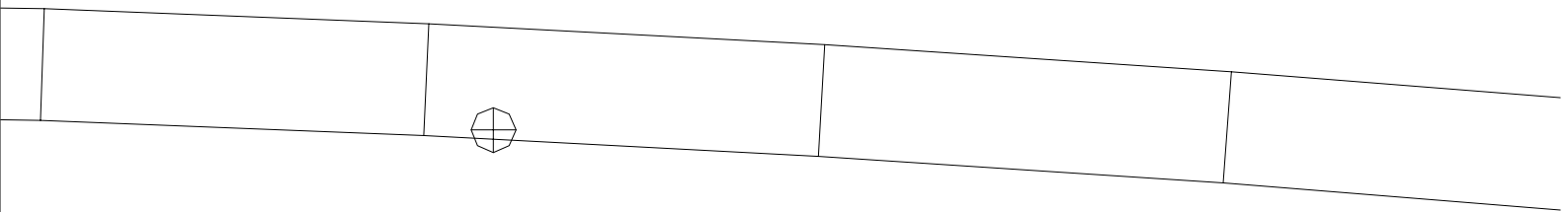

5-5





5-6

5-7



5-8

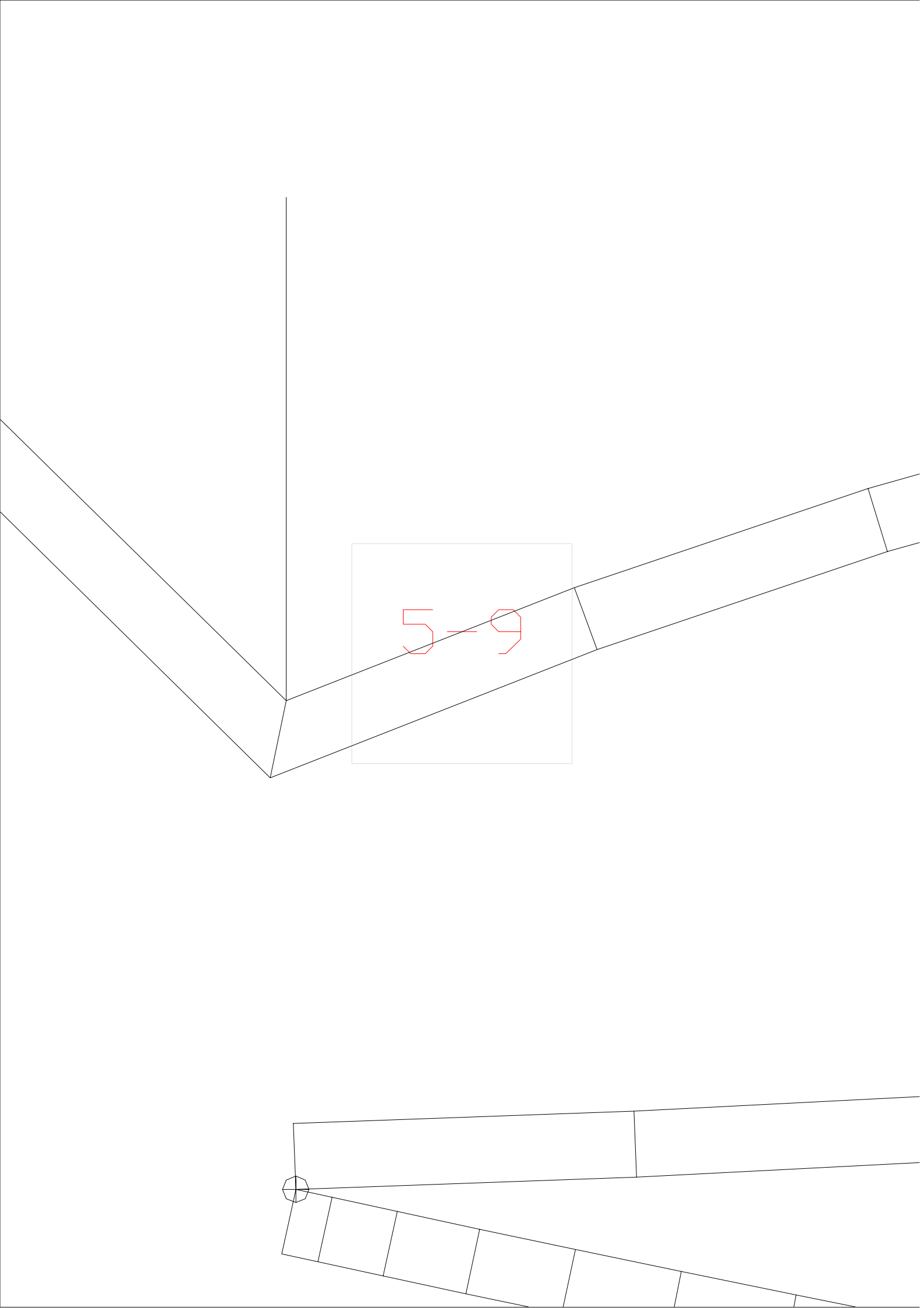

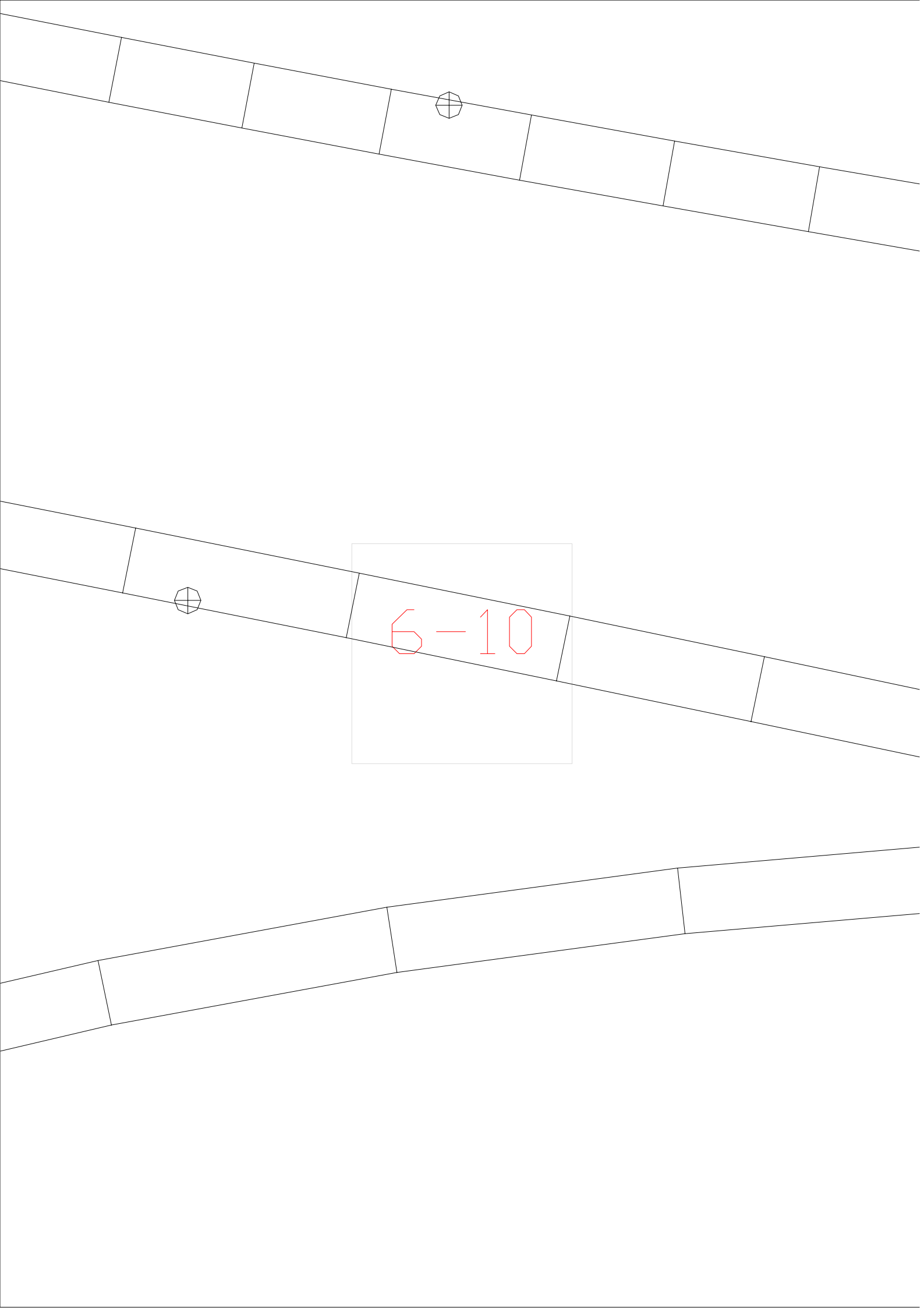

6-10

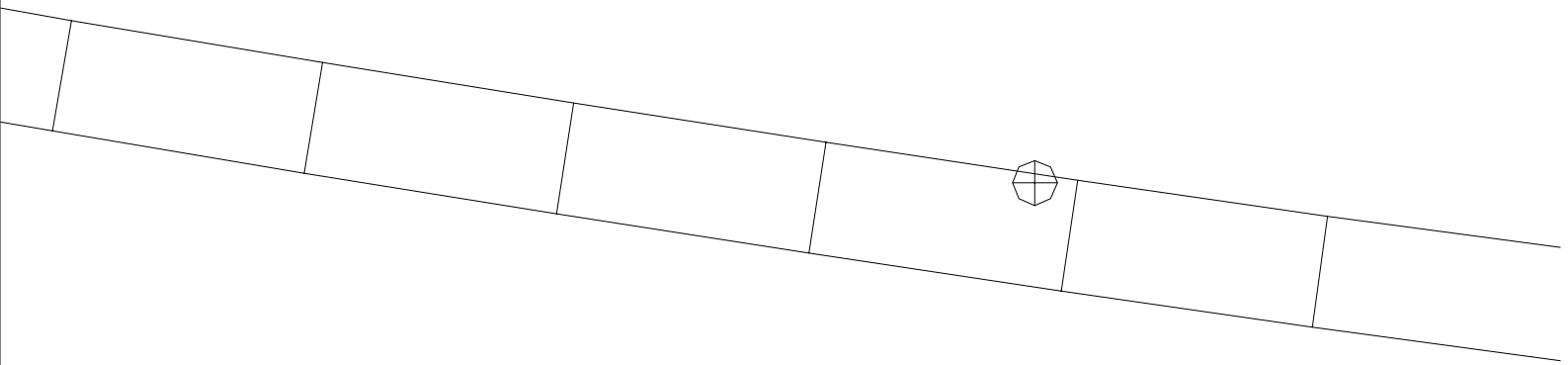

6-11

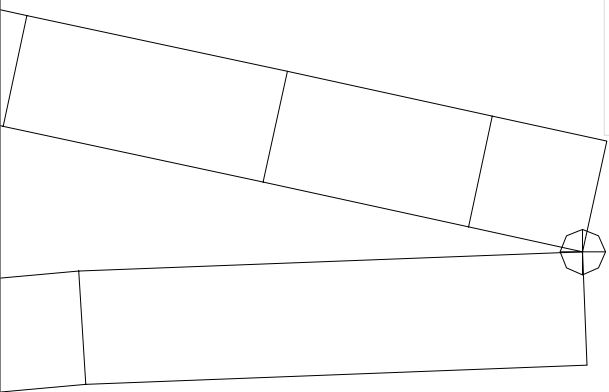

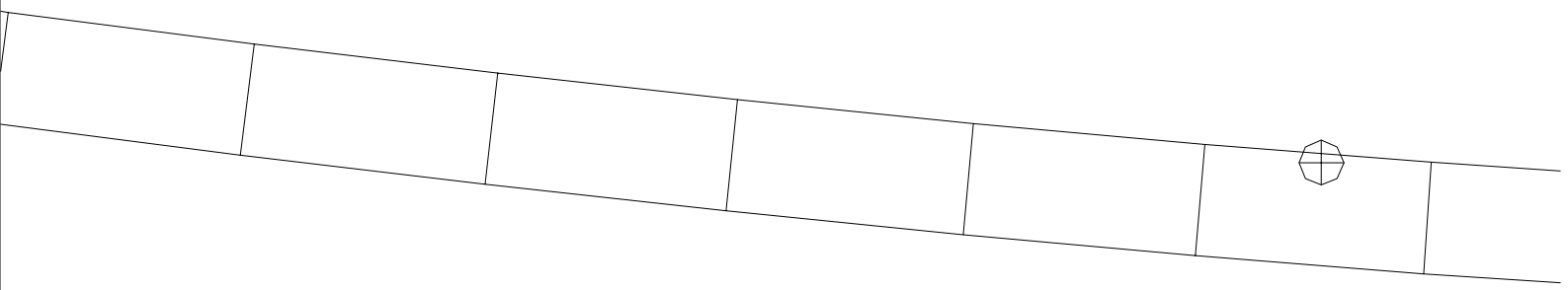

6-12

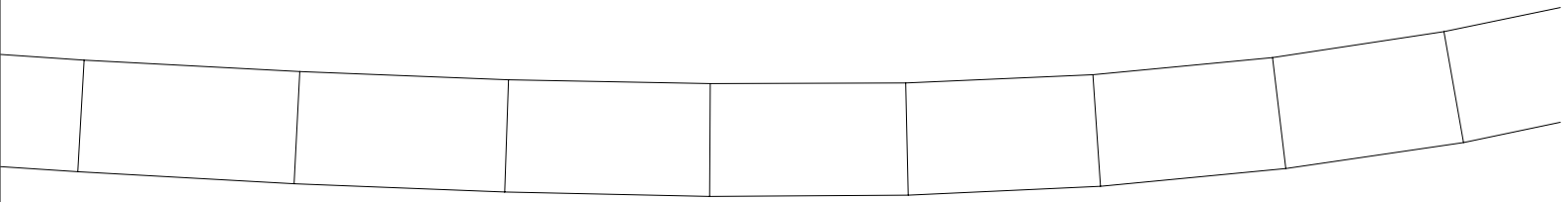

6-13

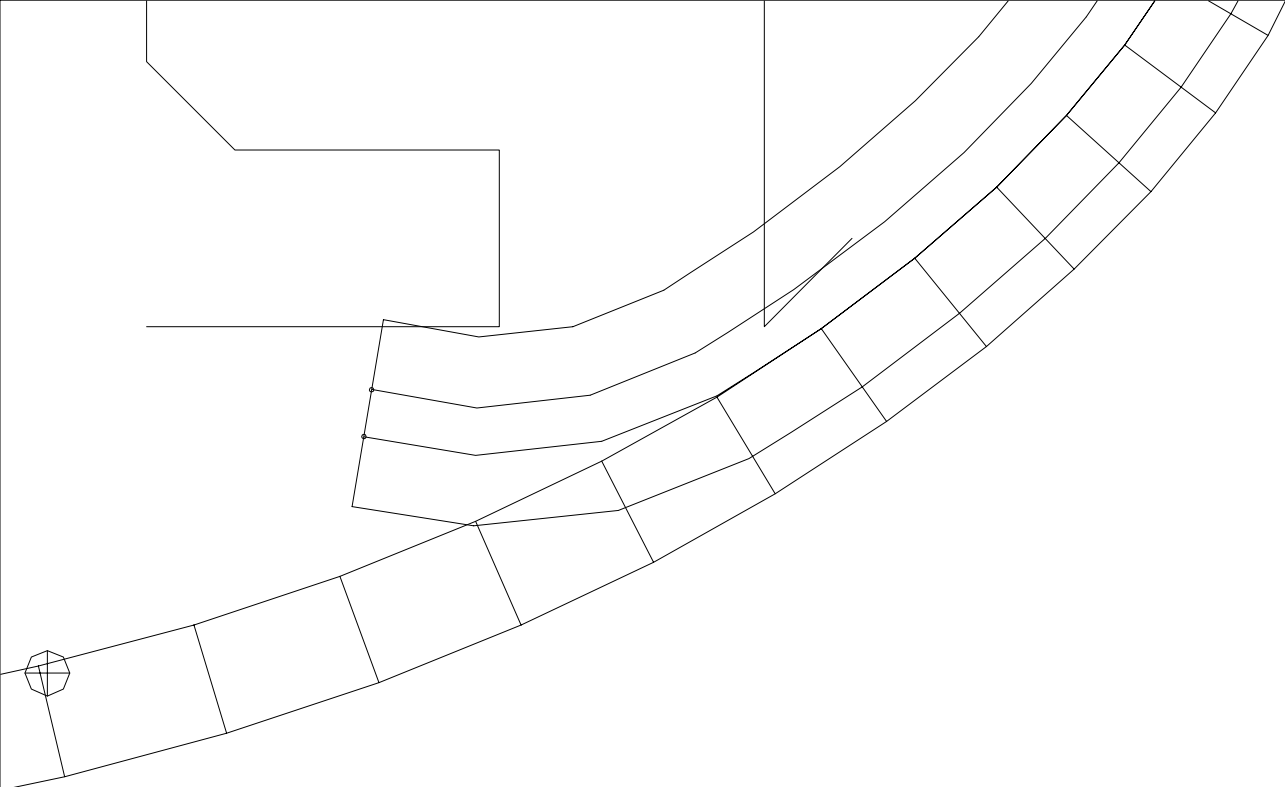

6-14

6-15

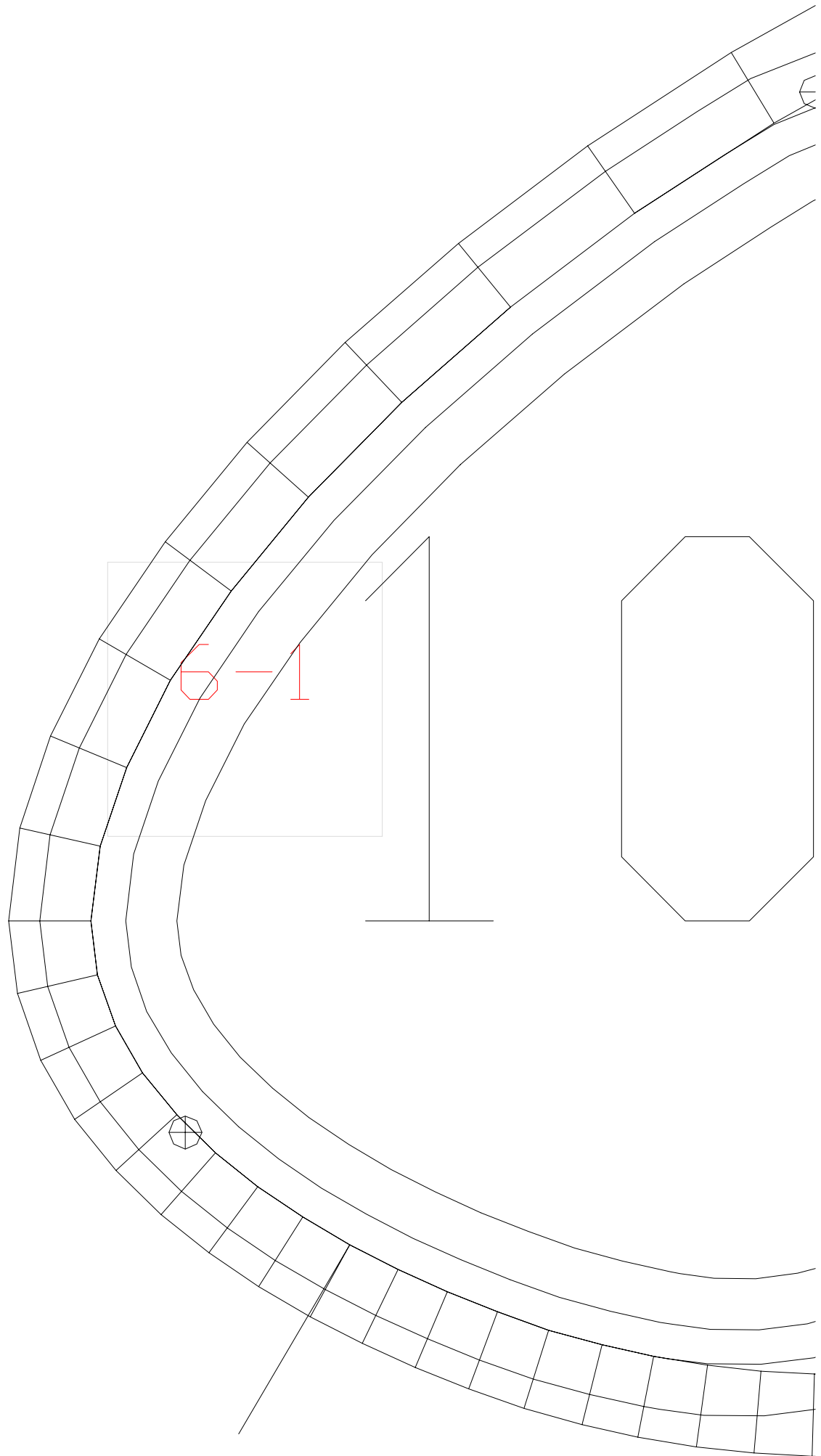

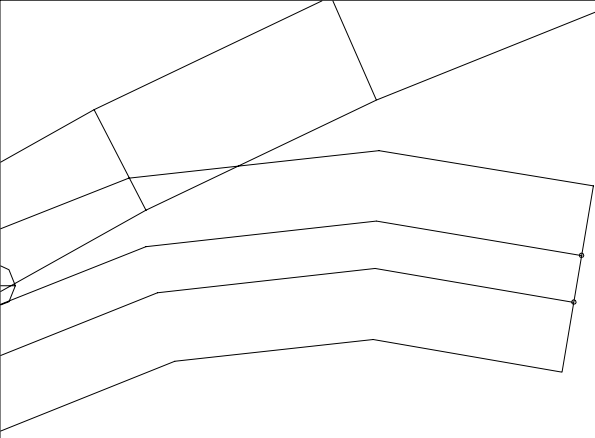

6-2

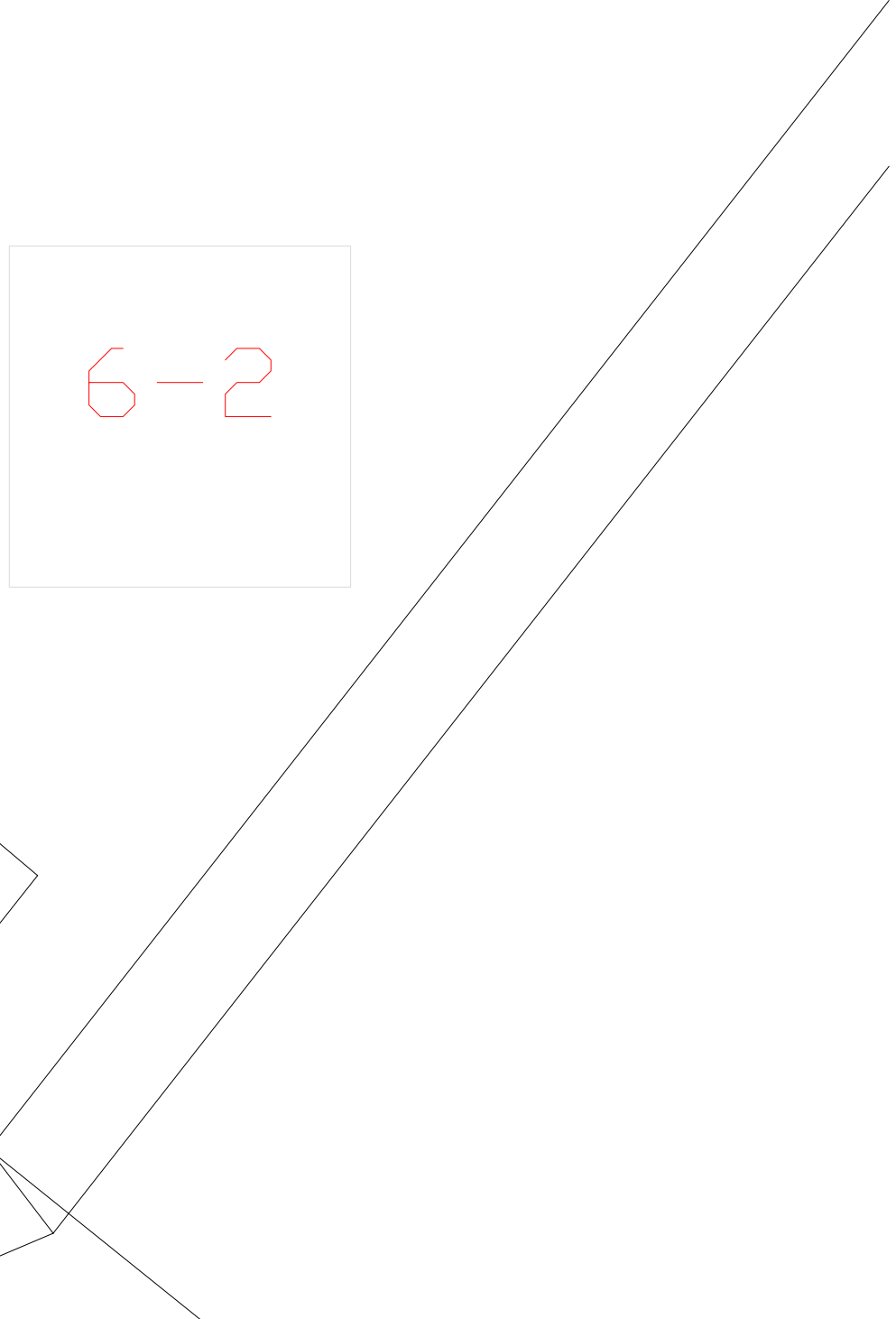
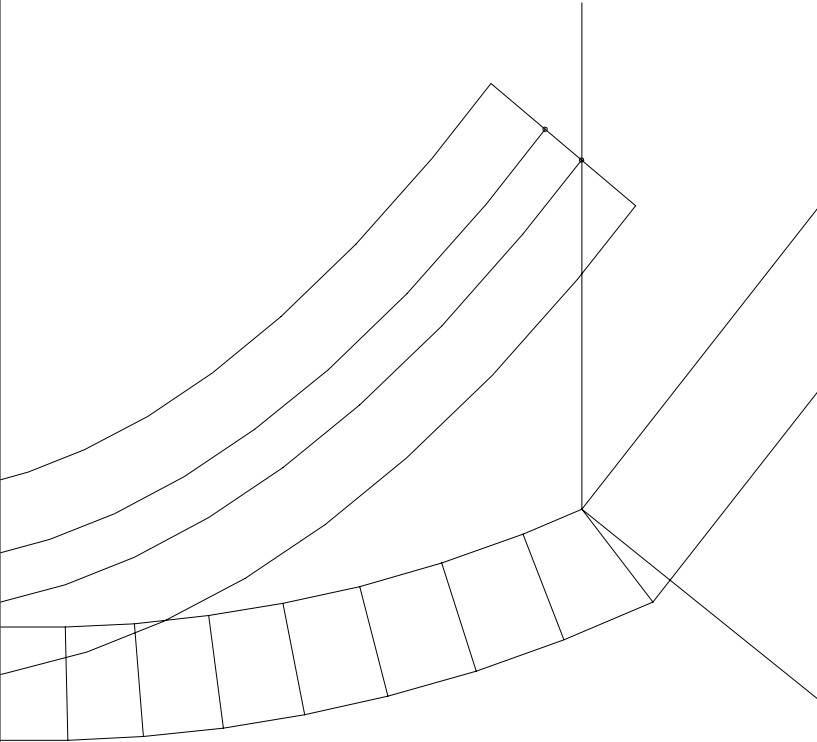



6-3



6-4

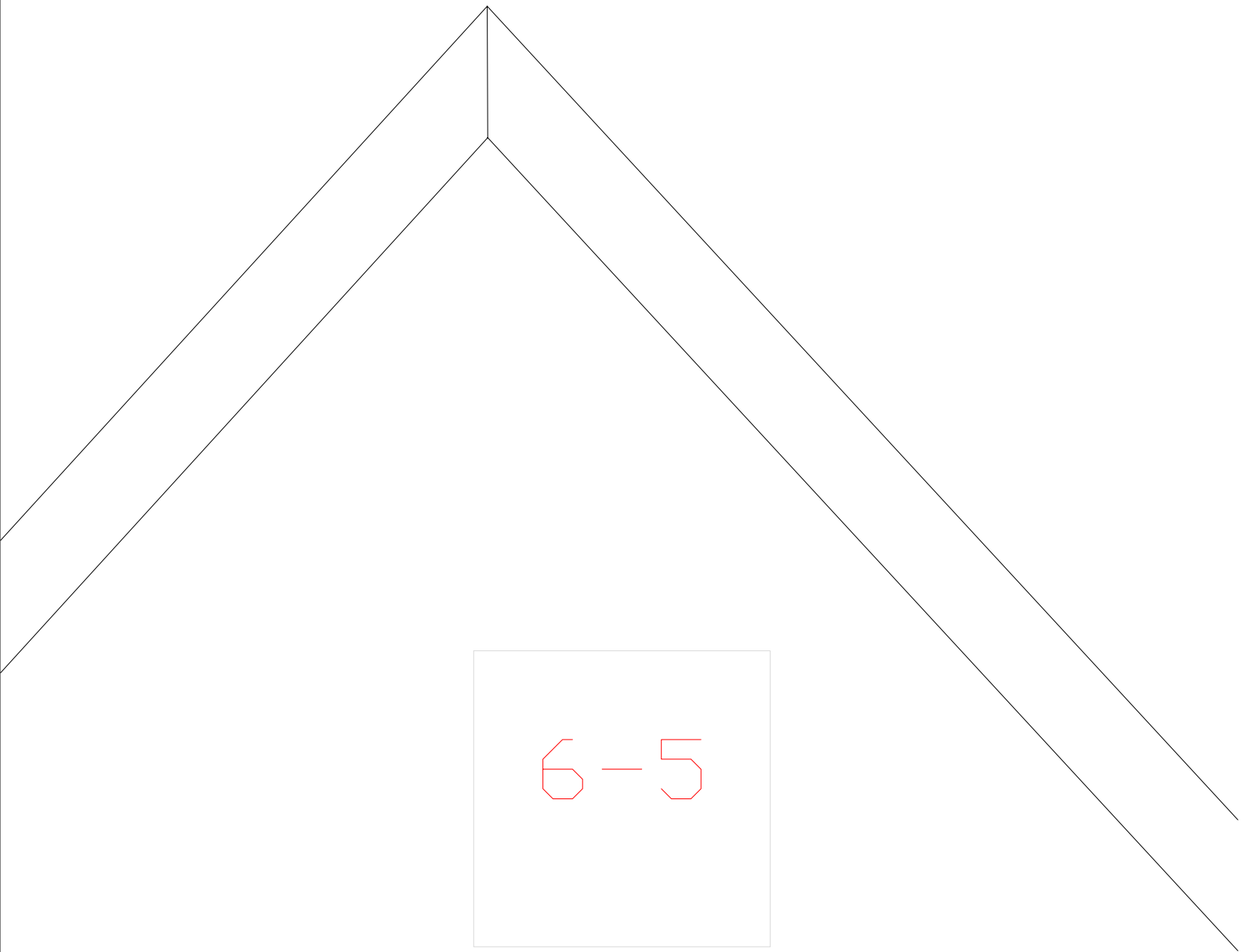



6-6

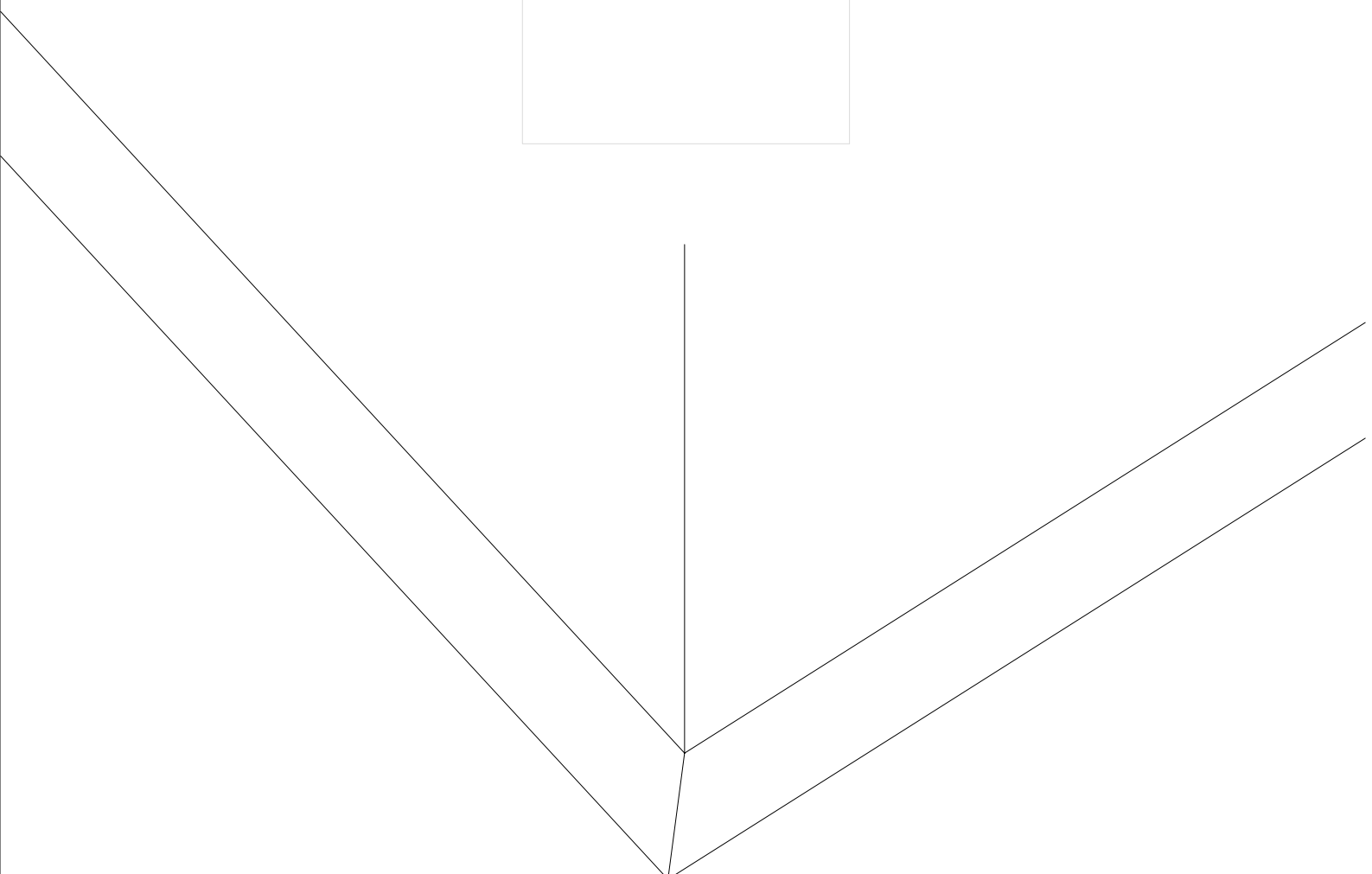

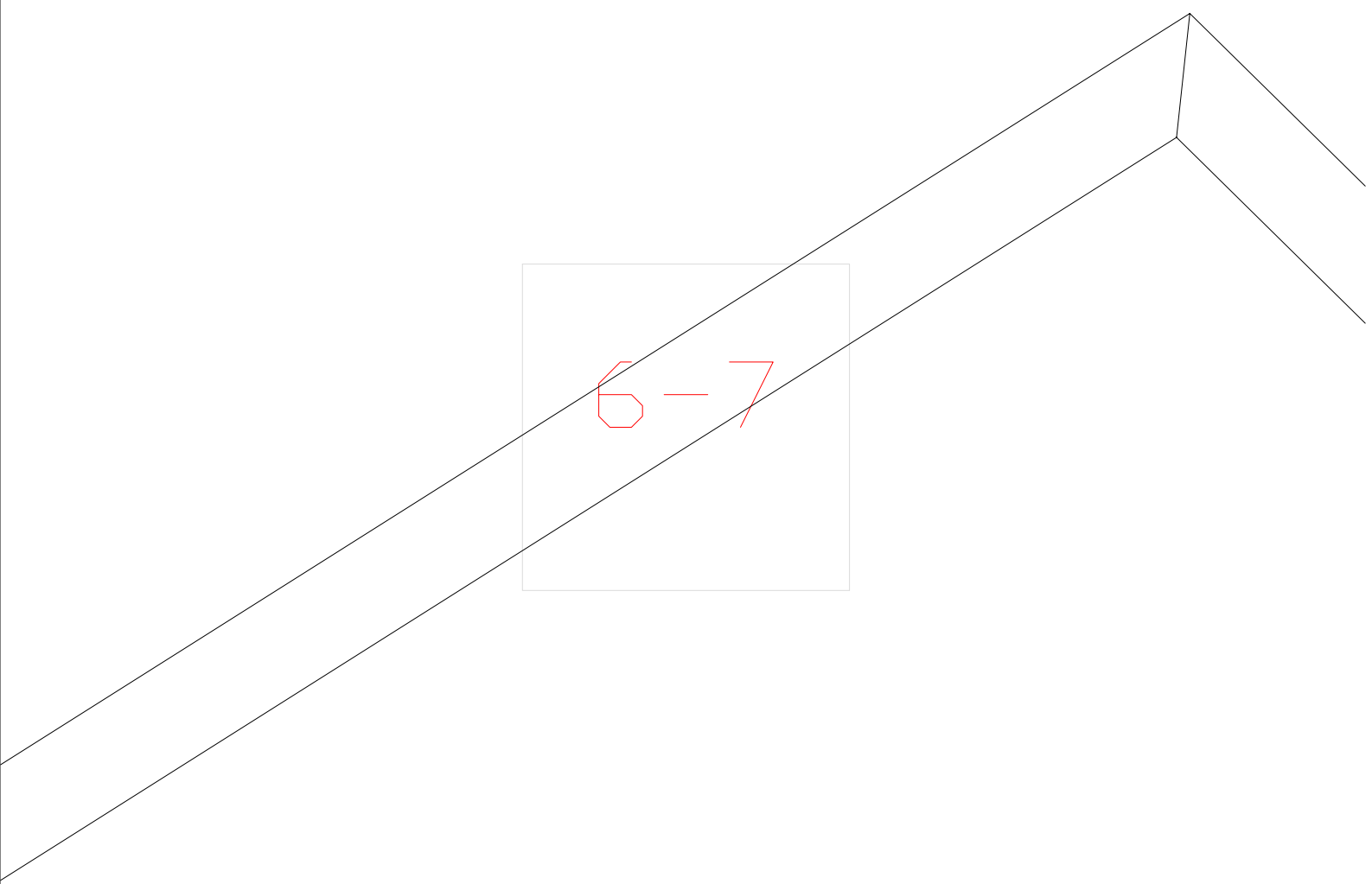
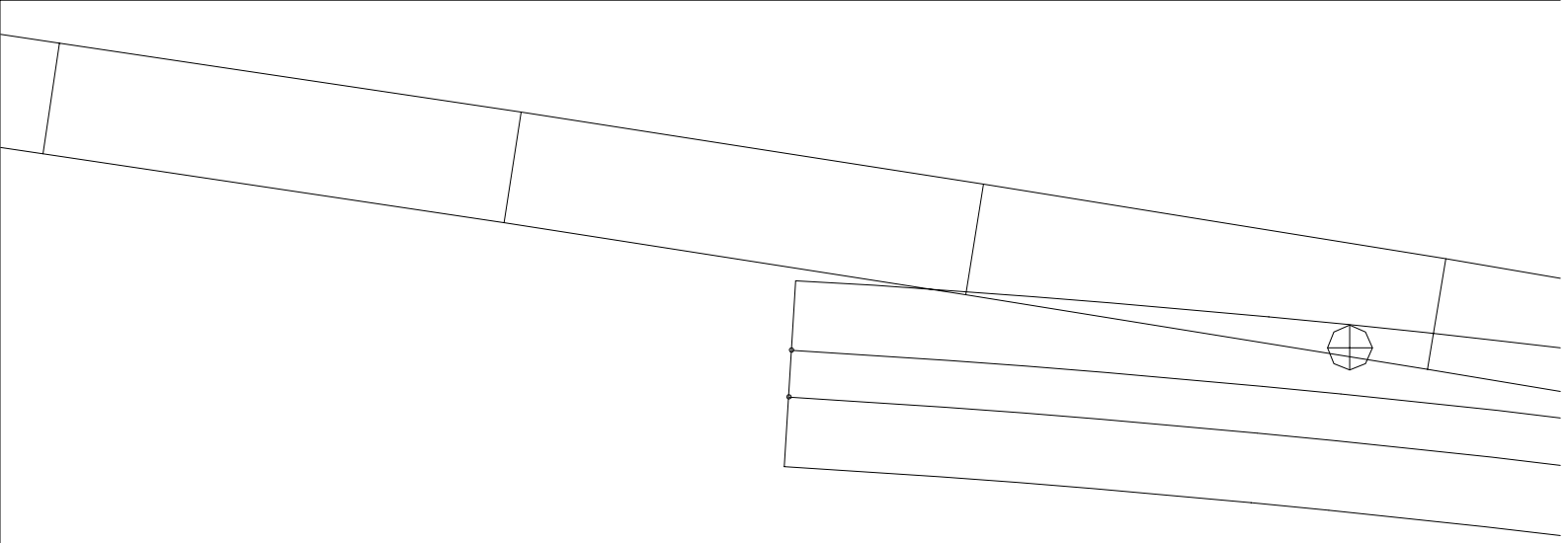

6-7

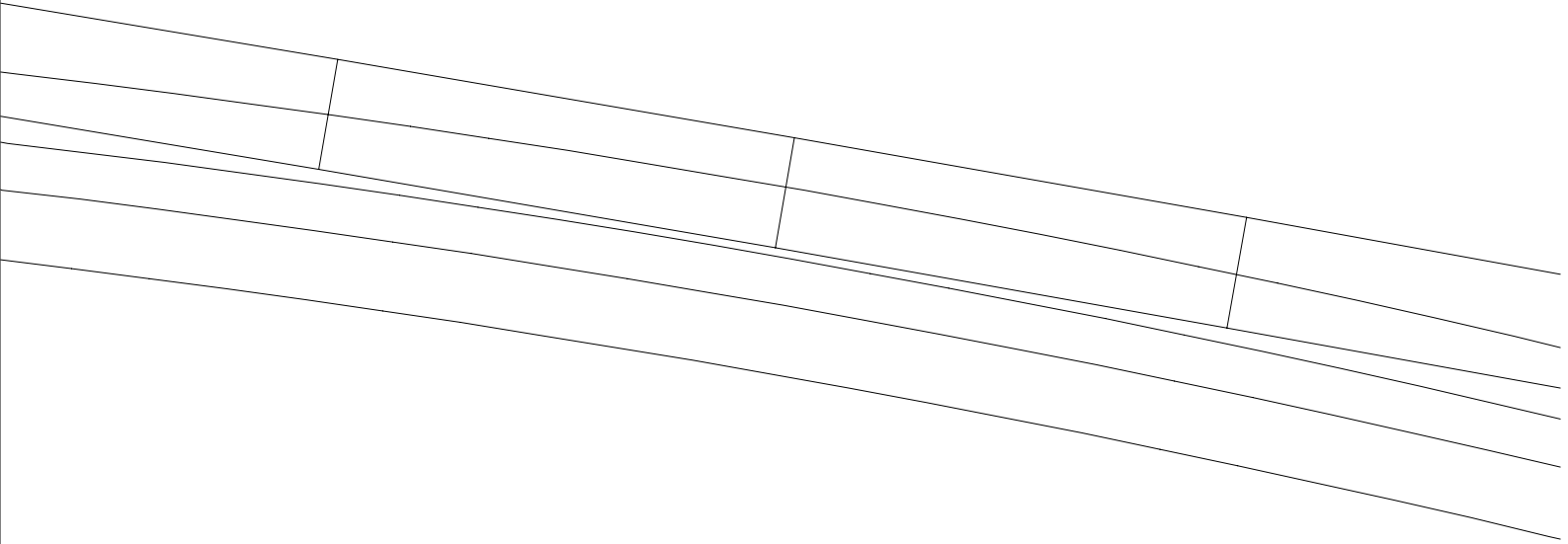

6-8

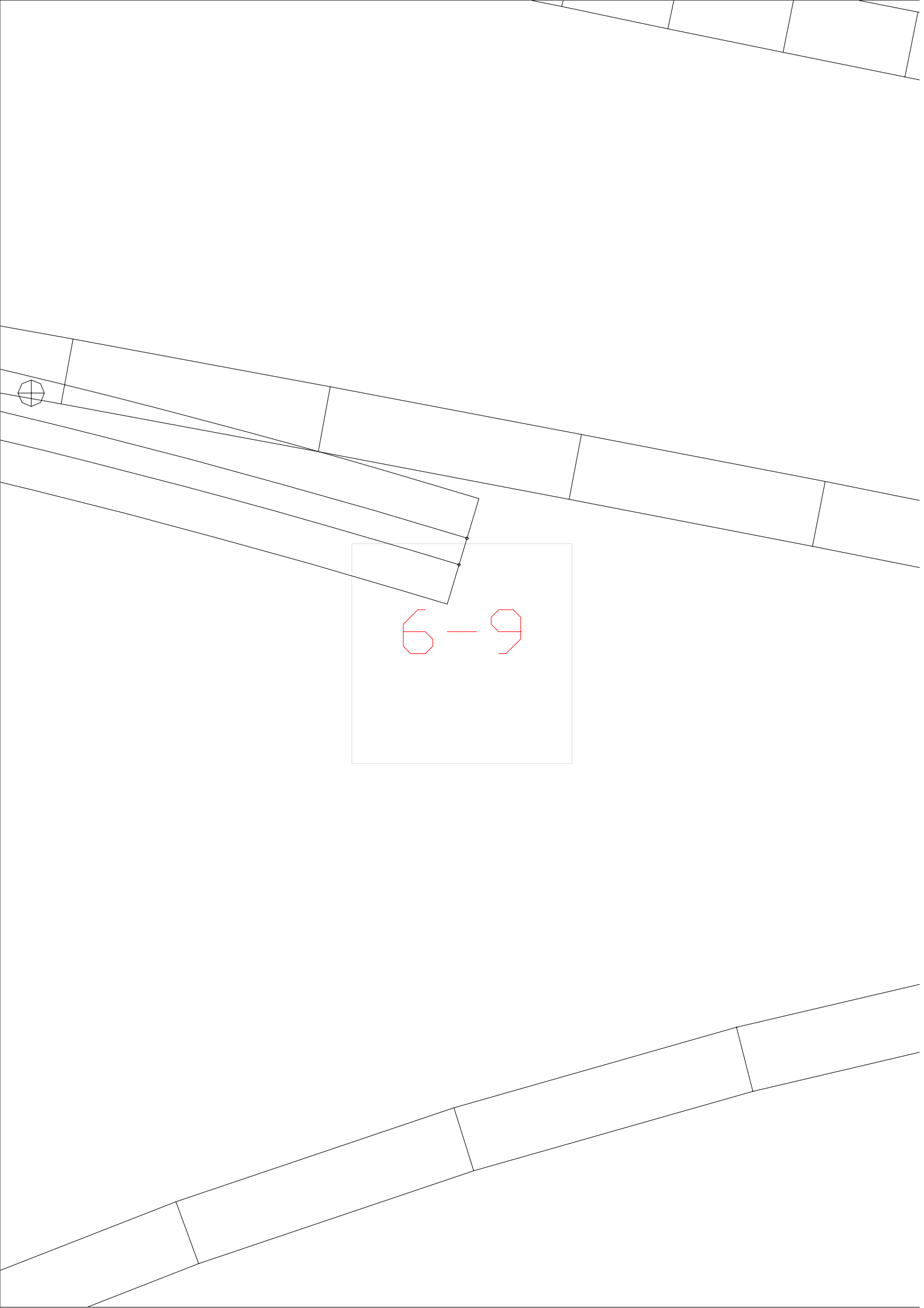

6-9

7-10

The image shows a technical drawing of a V-shaped groove. A rectangular hole is cut into the bottom of the groove, with the number '7-10' written in red inside it. Below the groove, there is a flange-like structure with a bolted hole. The drawing is composed of black lines on a white background.



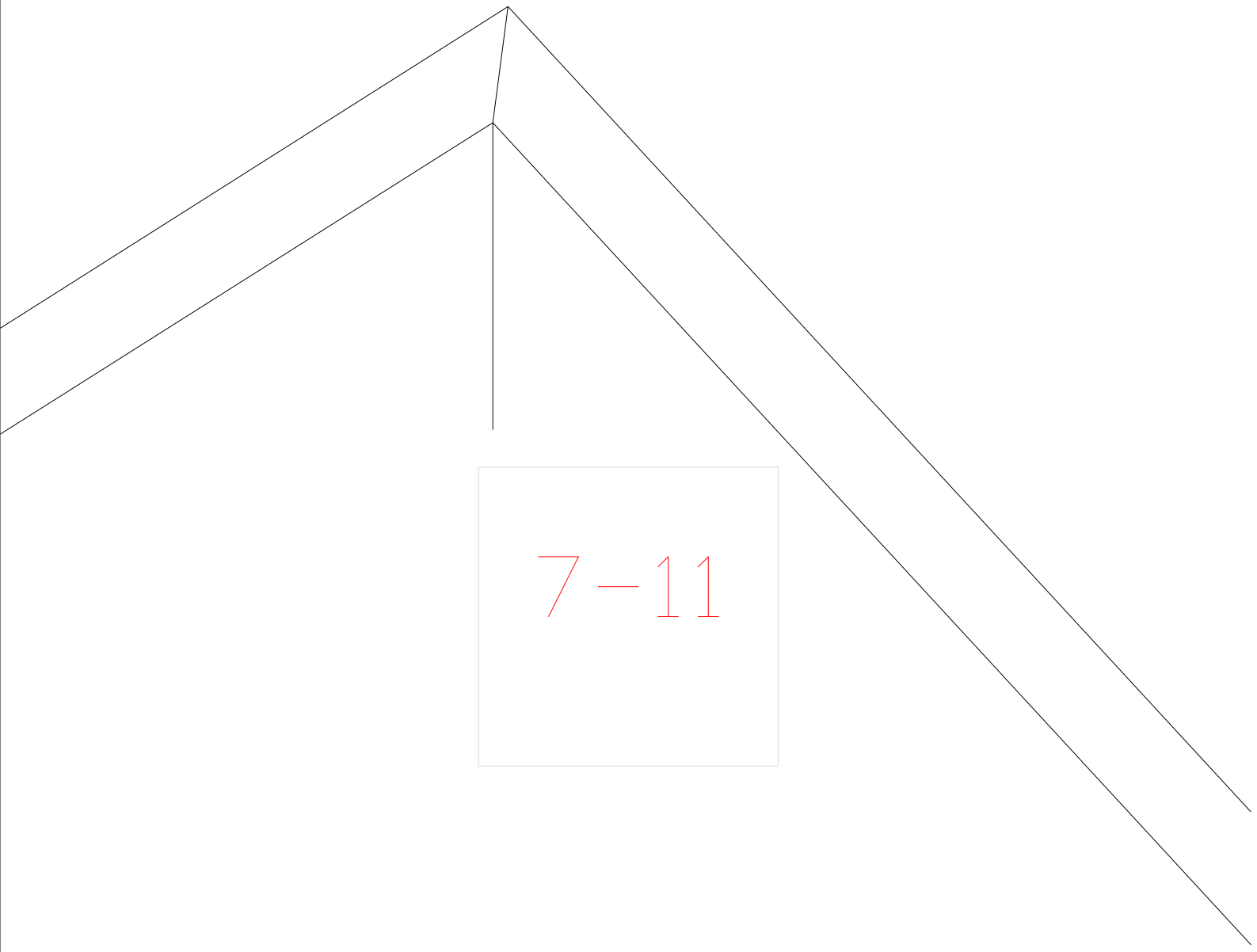

7-11

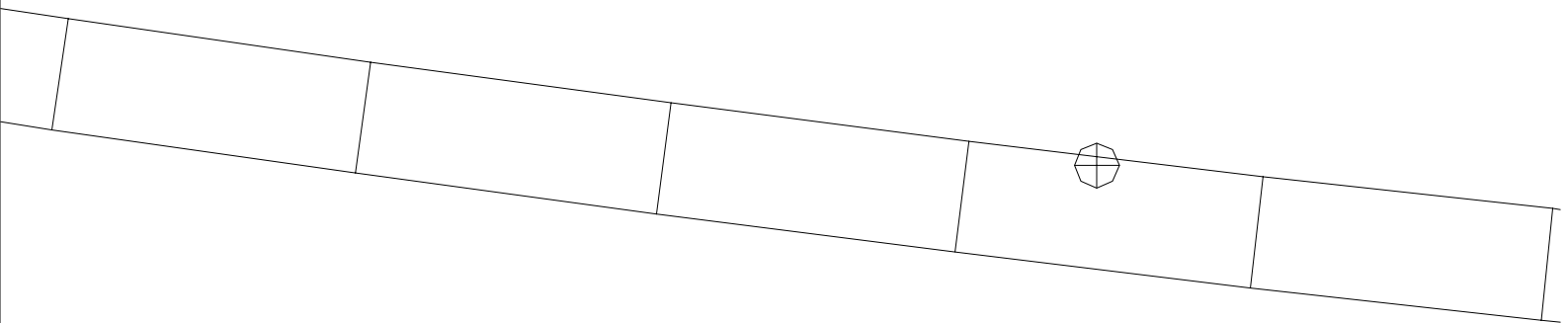

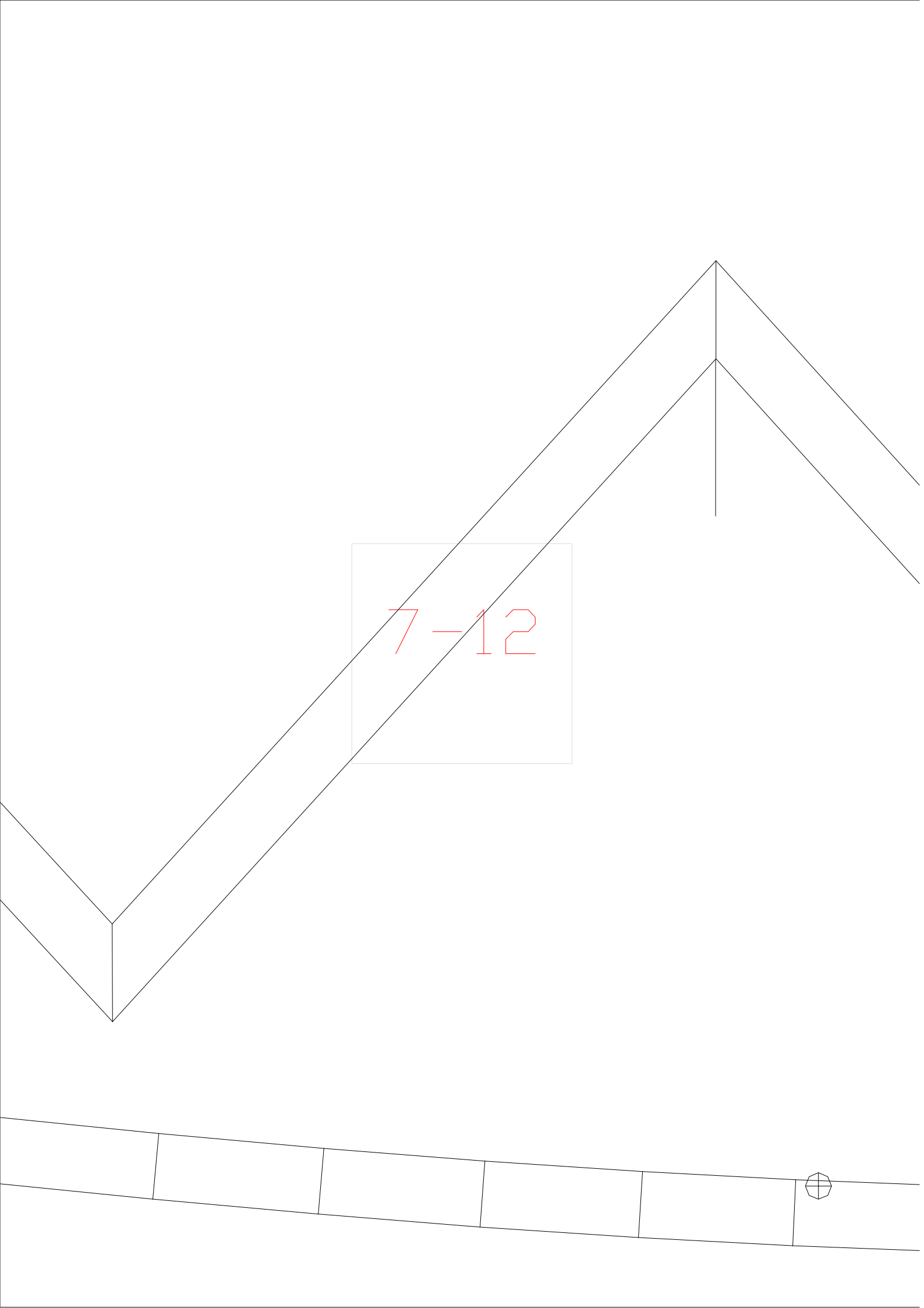

7-13

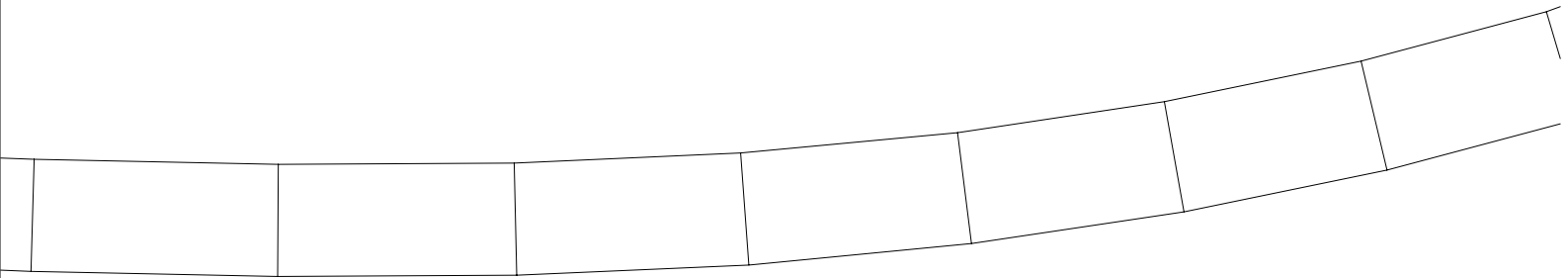

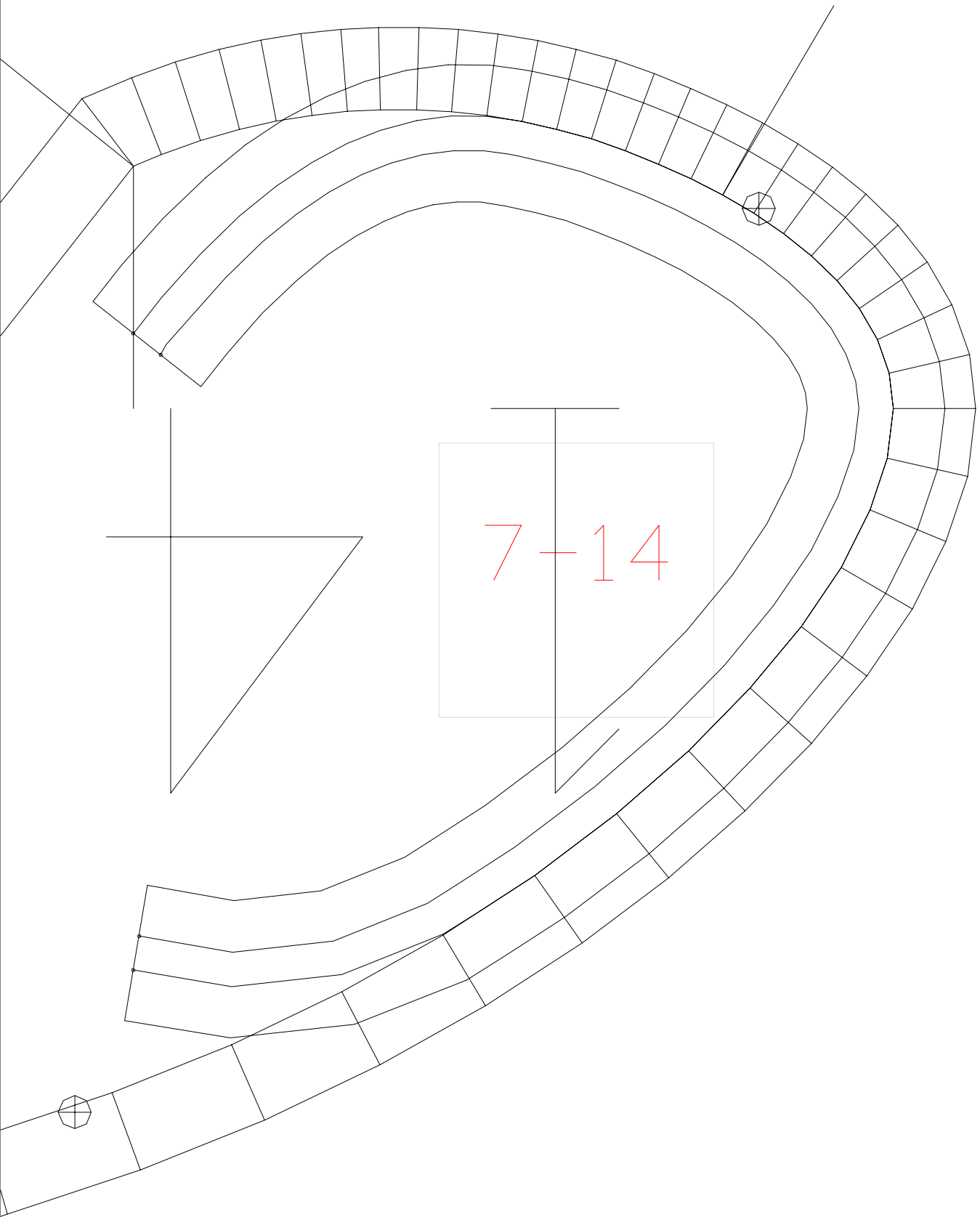

7-14

7-15

7-1

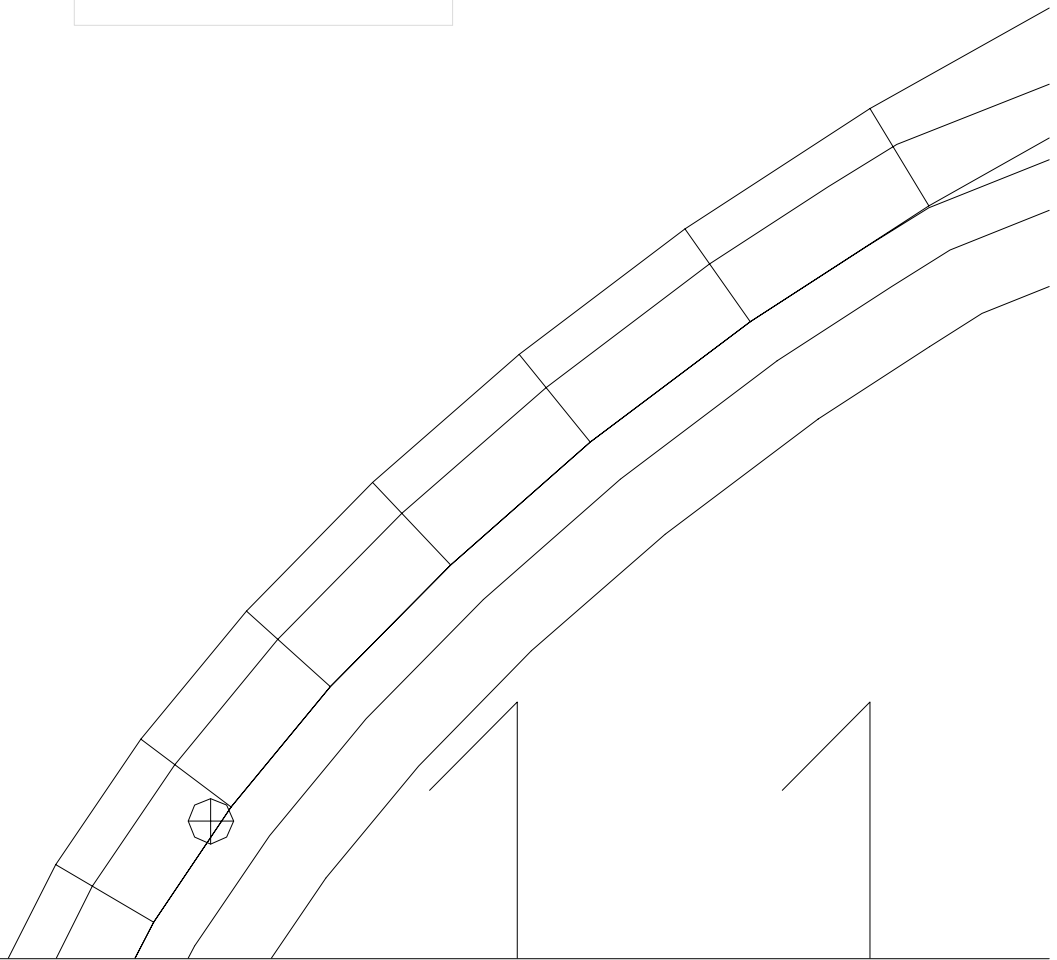

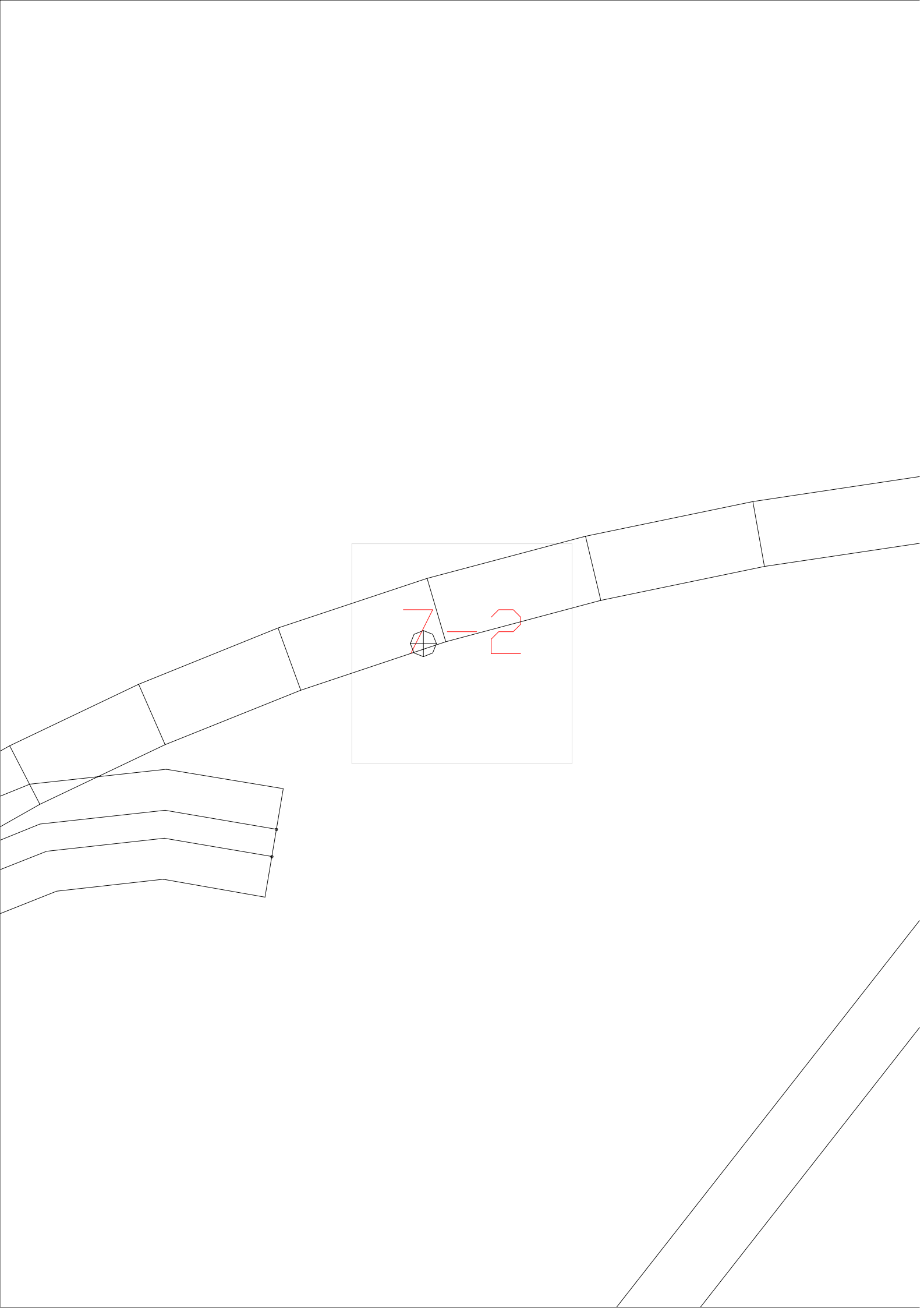

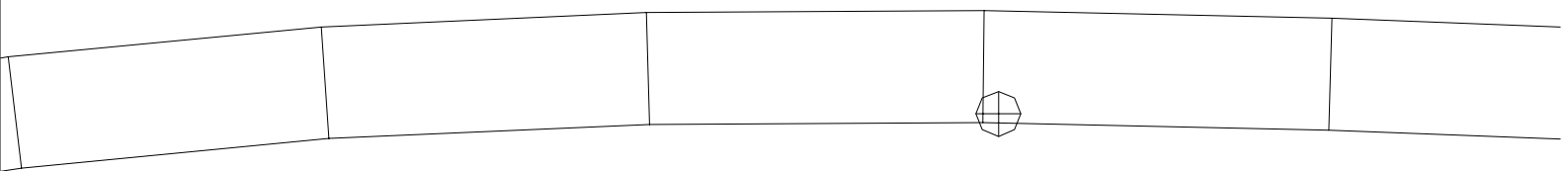

7-3

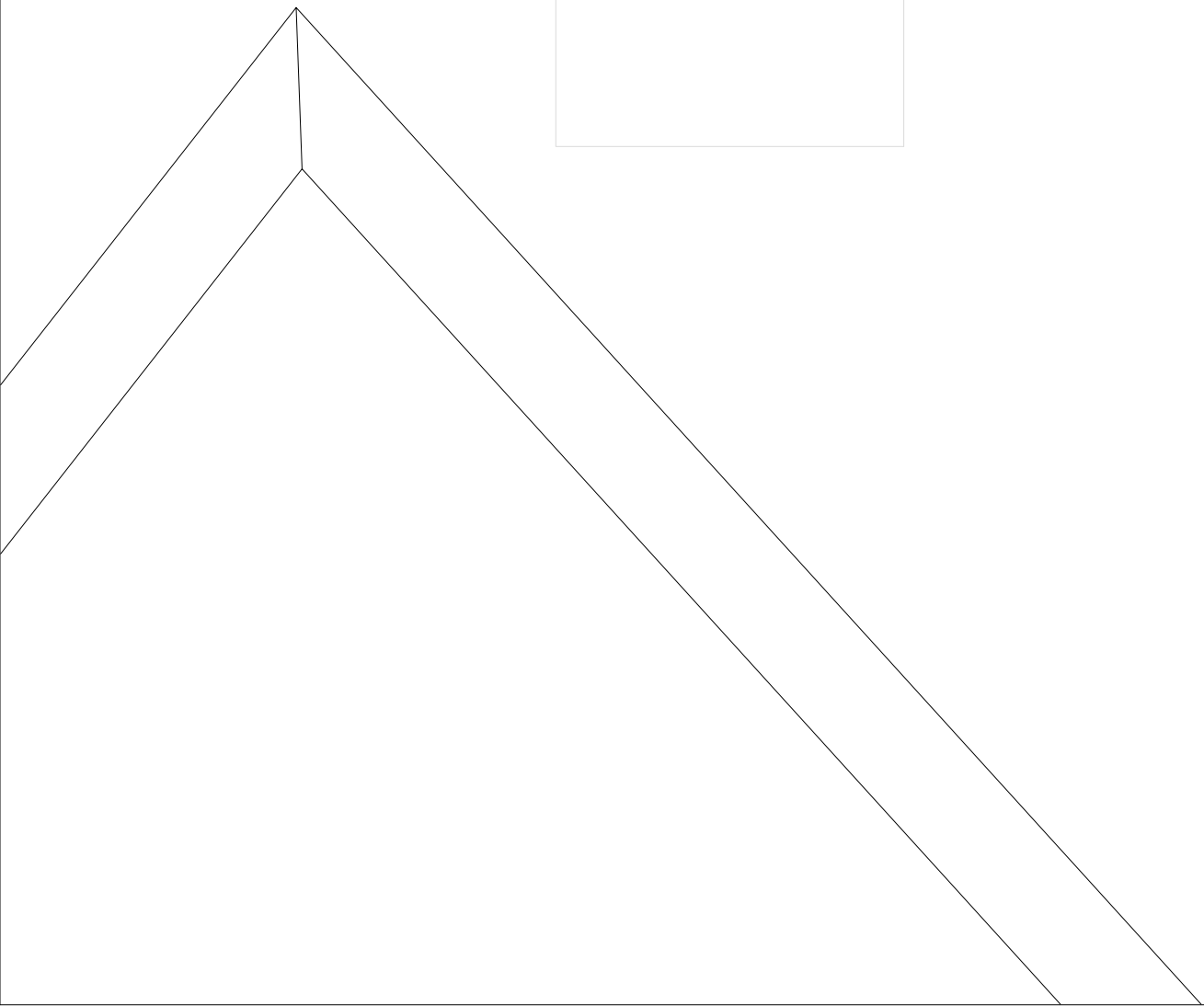

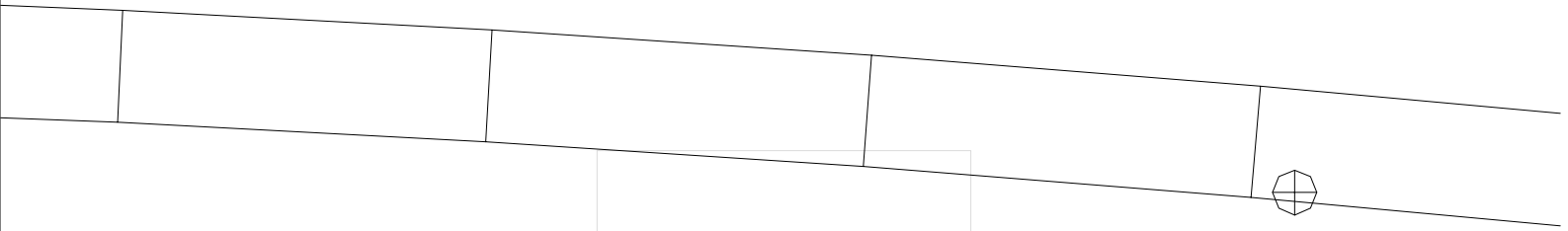

7-4

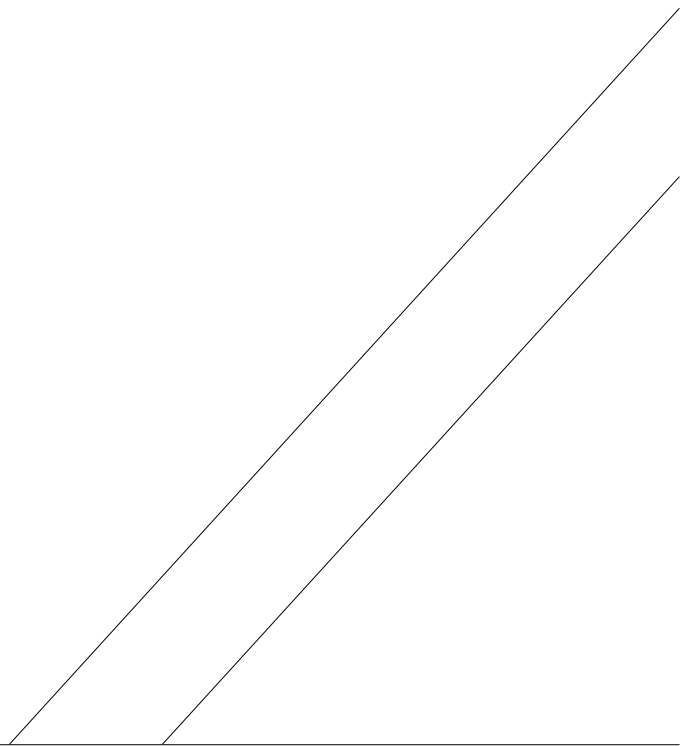

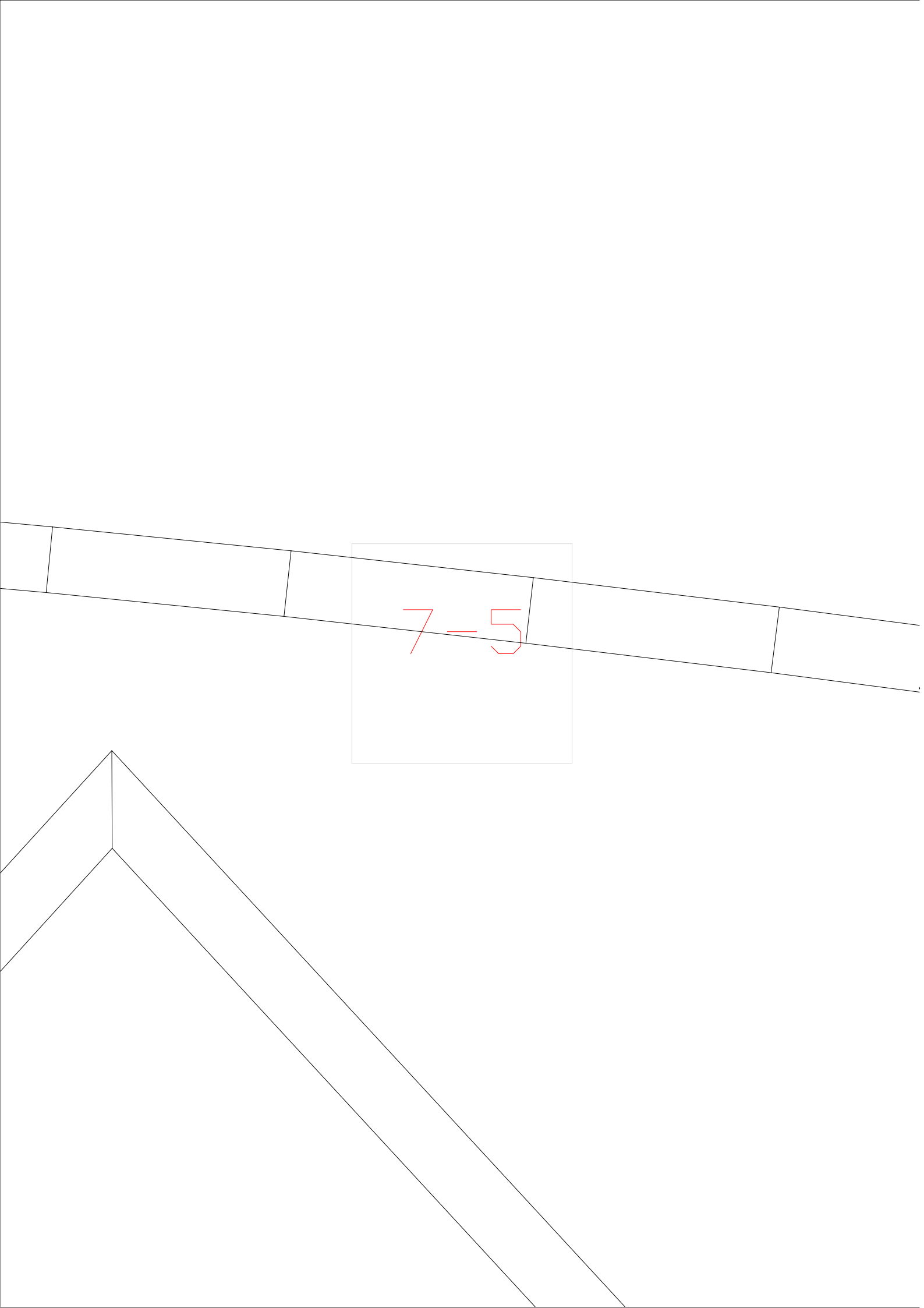

7-5

7-6

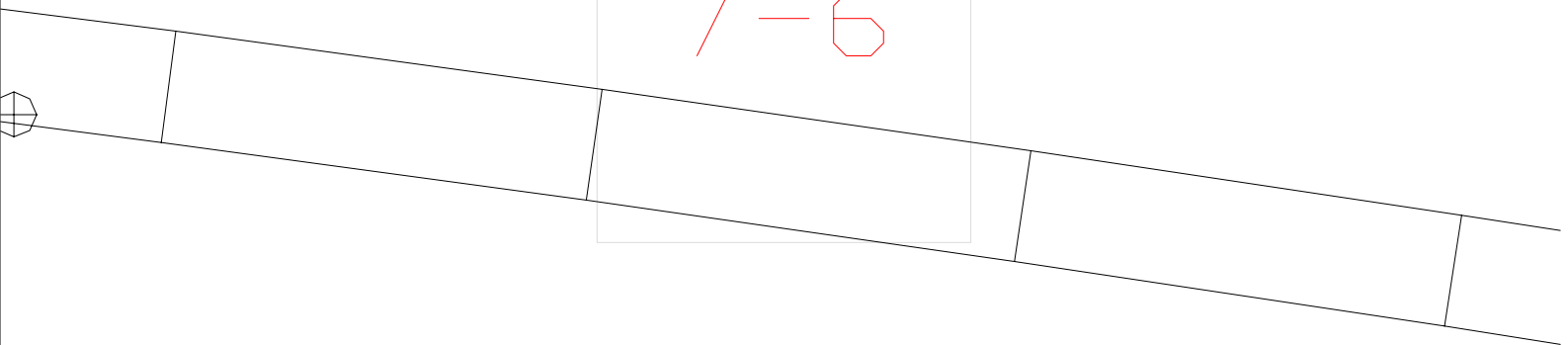

7-7

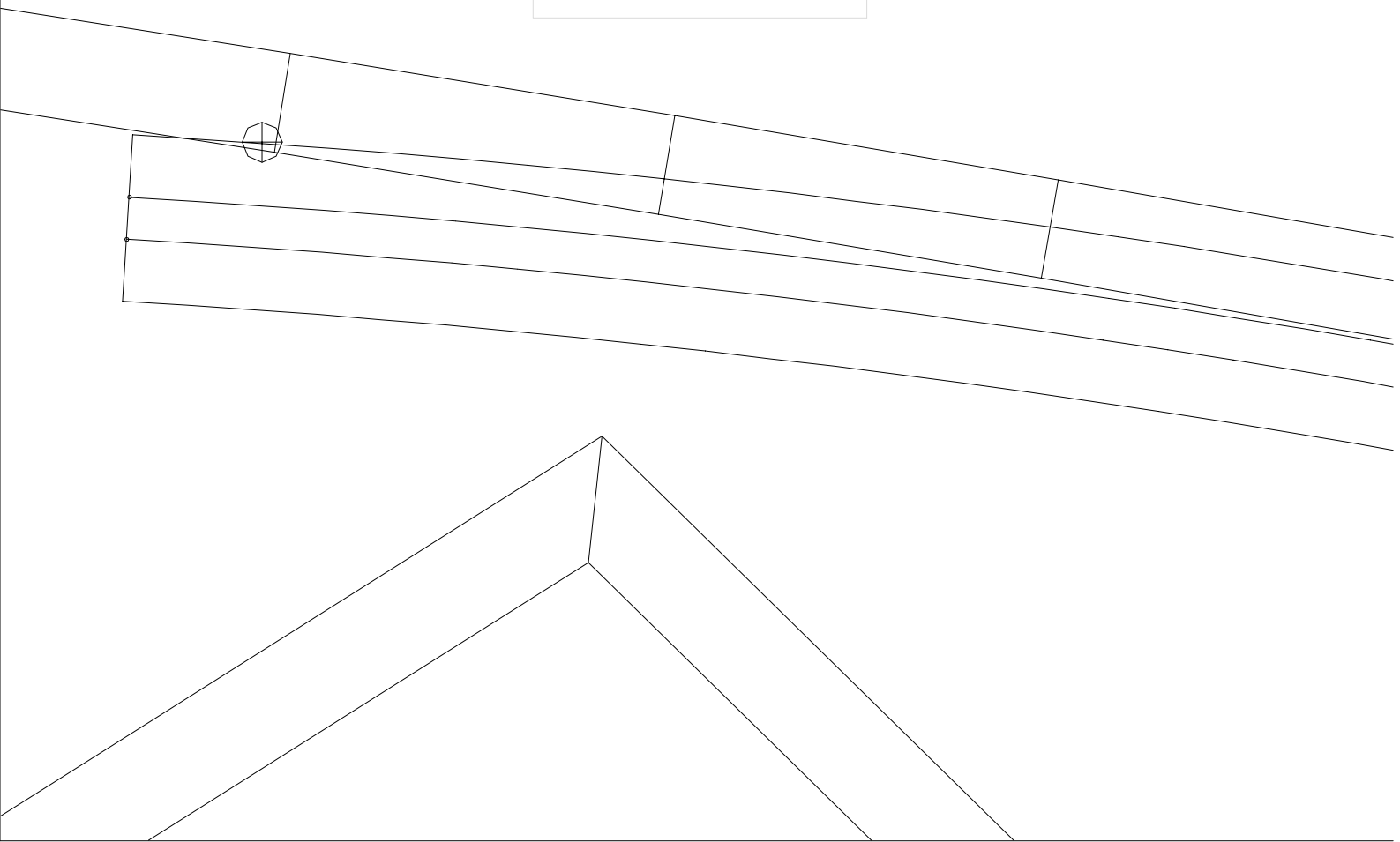

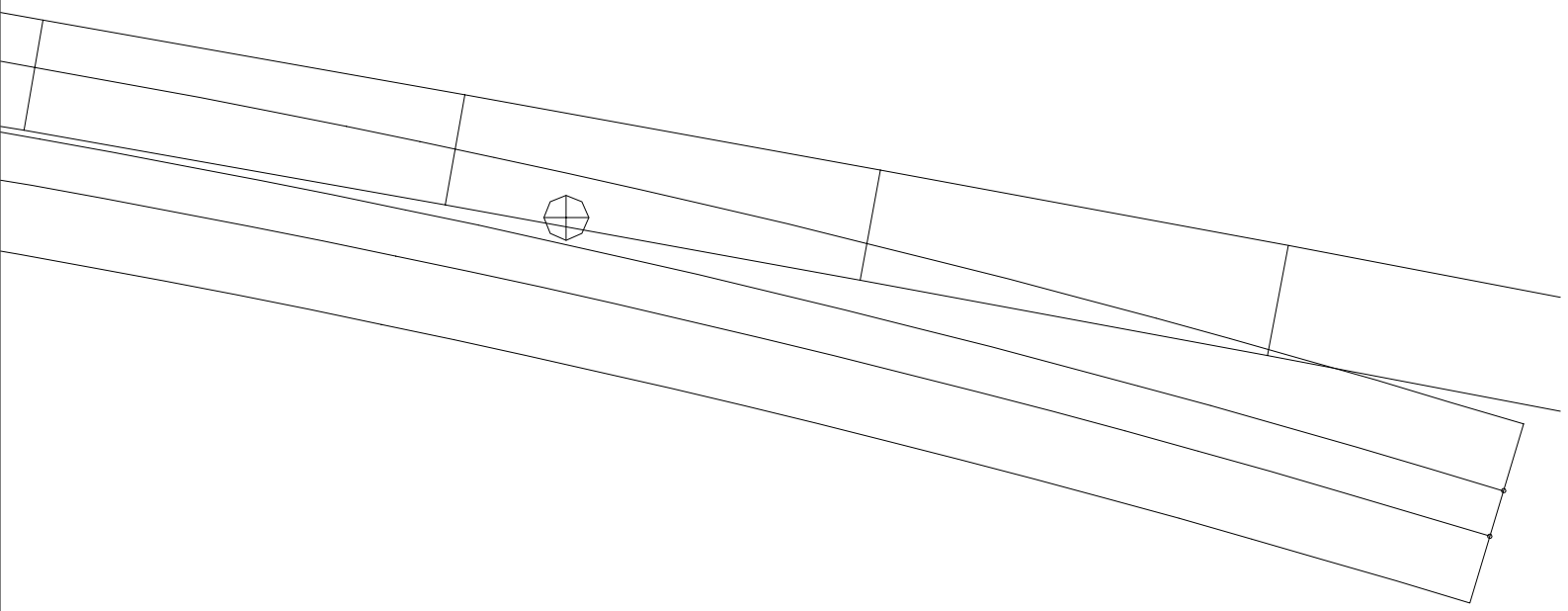
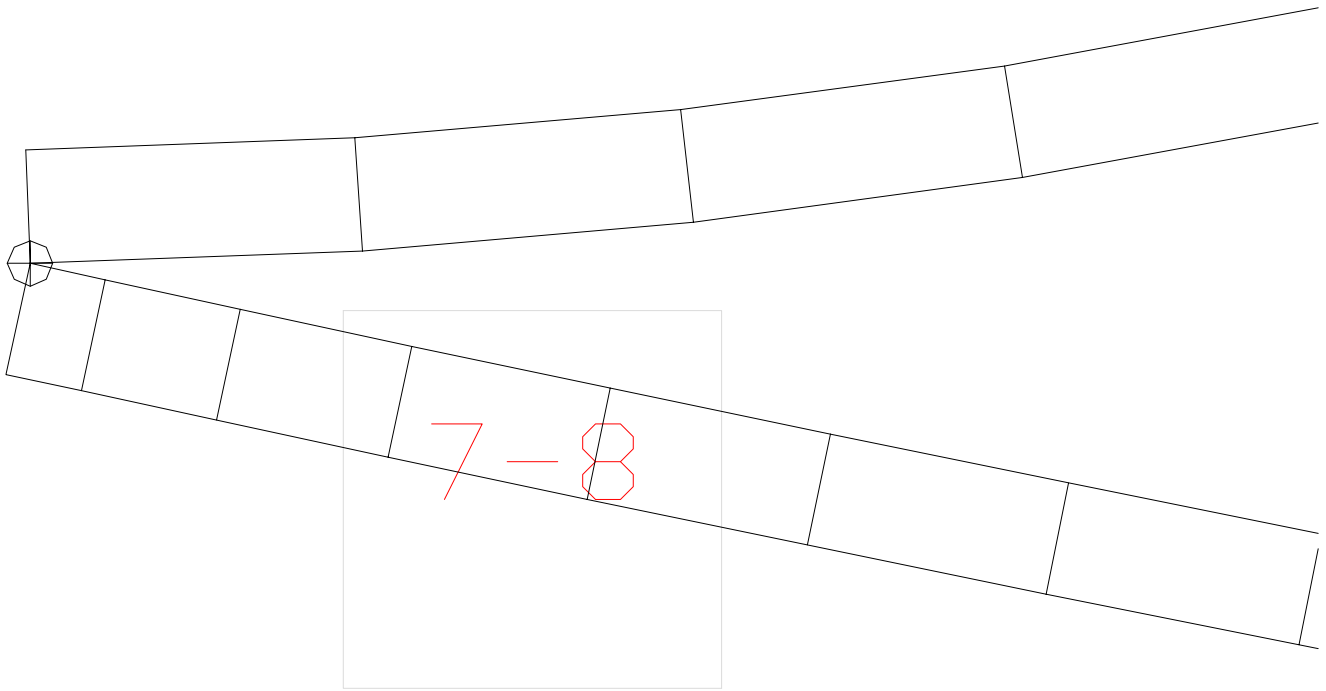

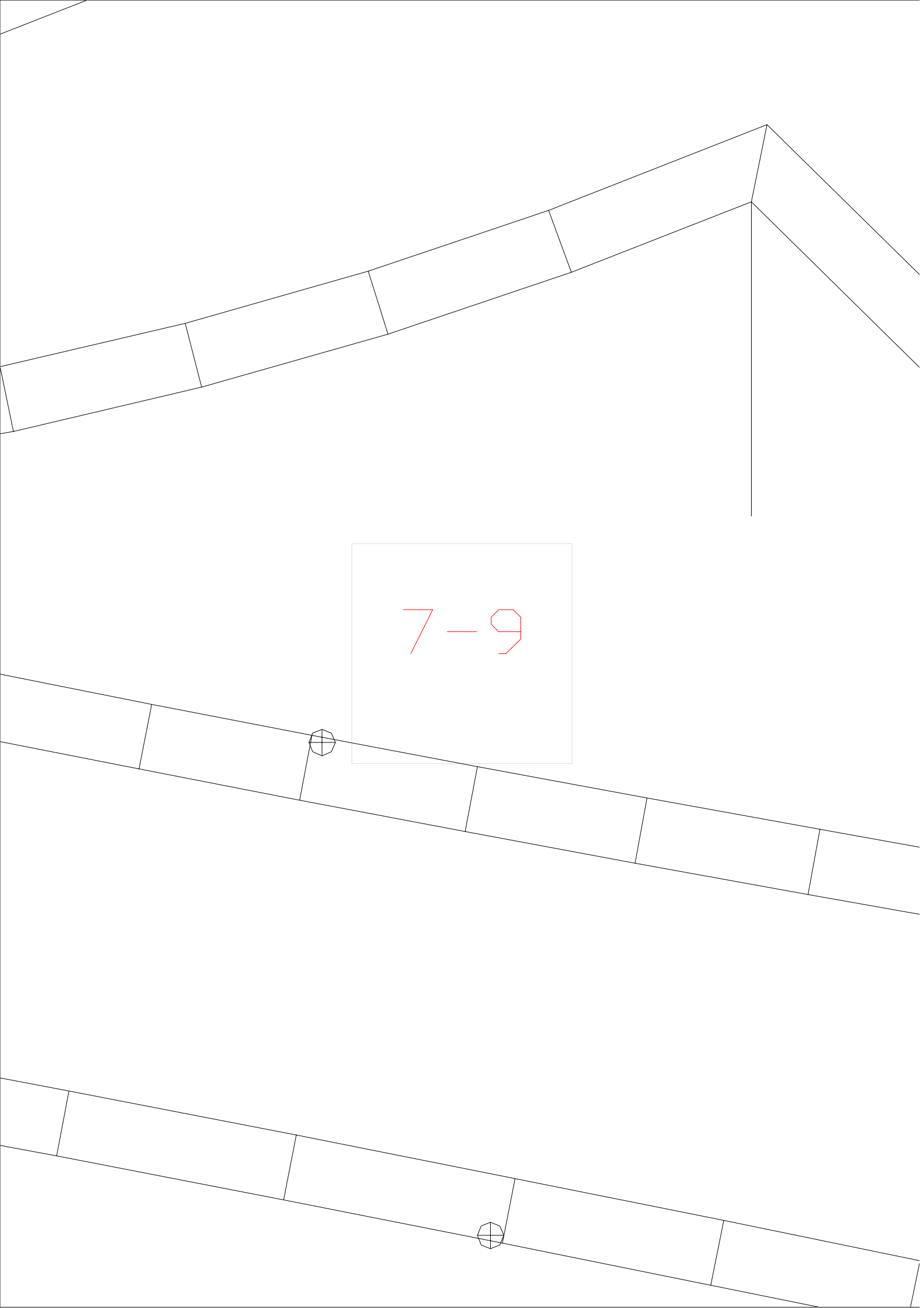

7-9

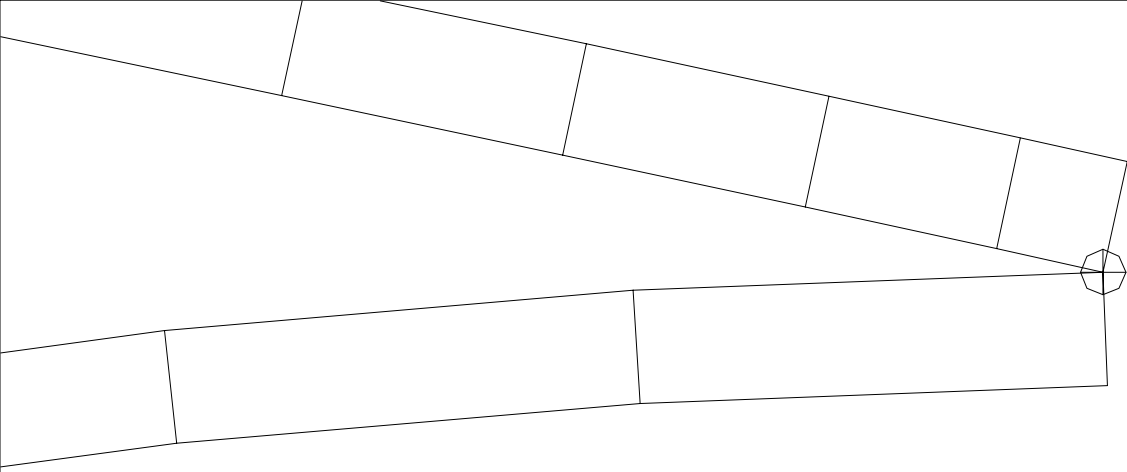

8-10

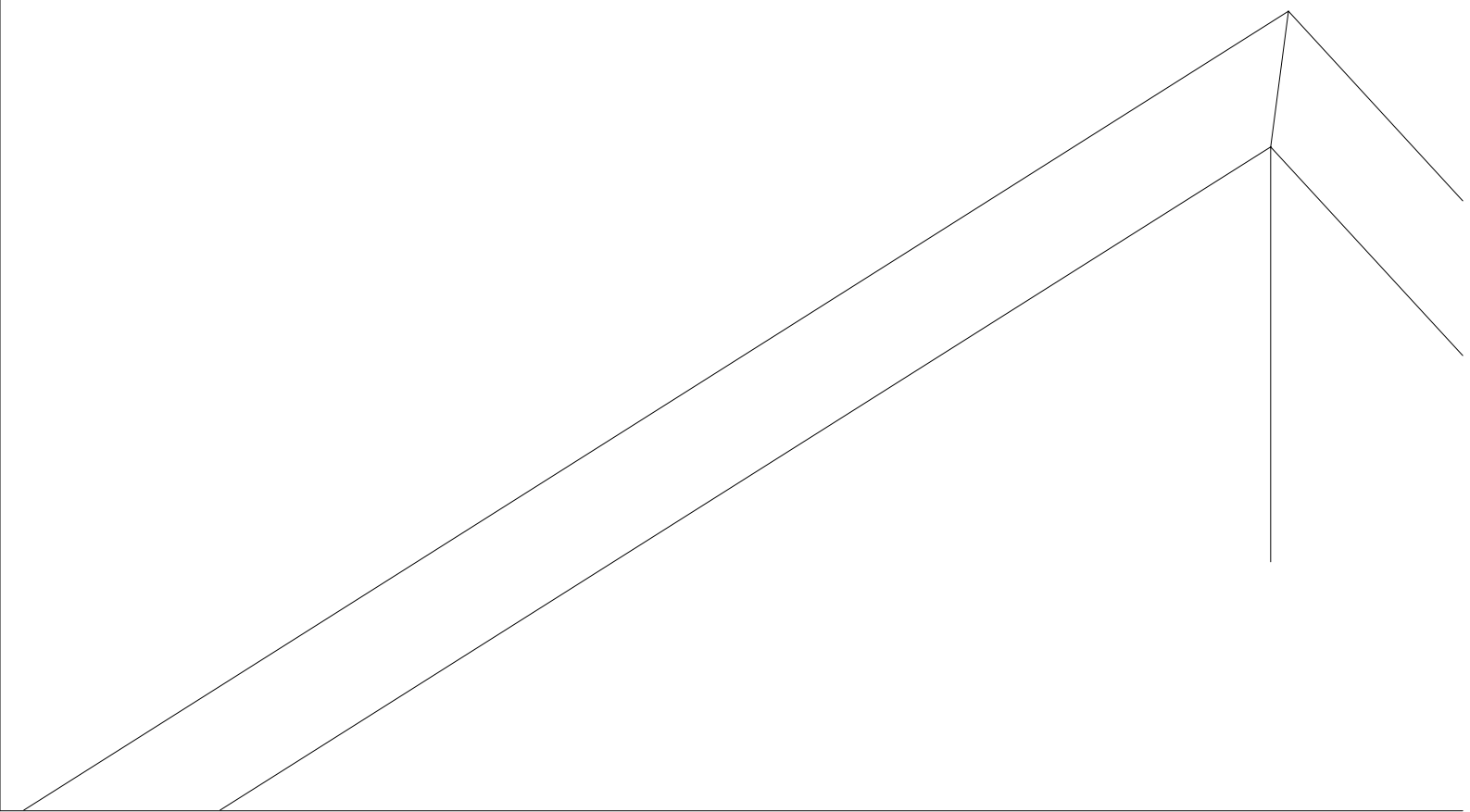

8-11

8-12

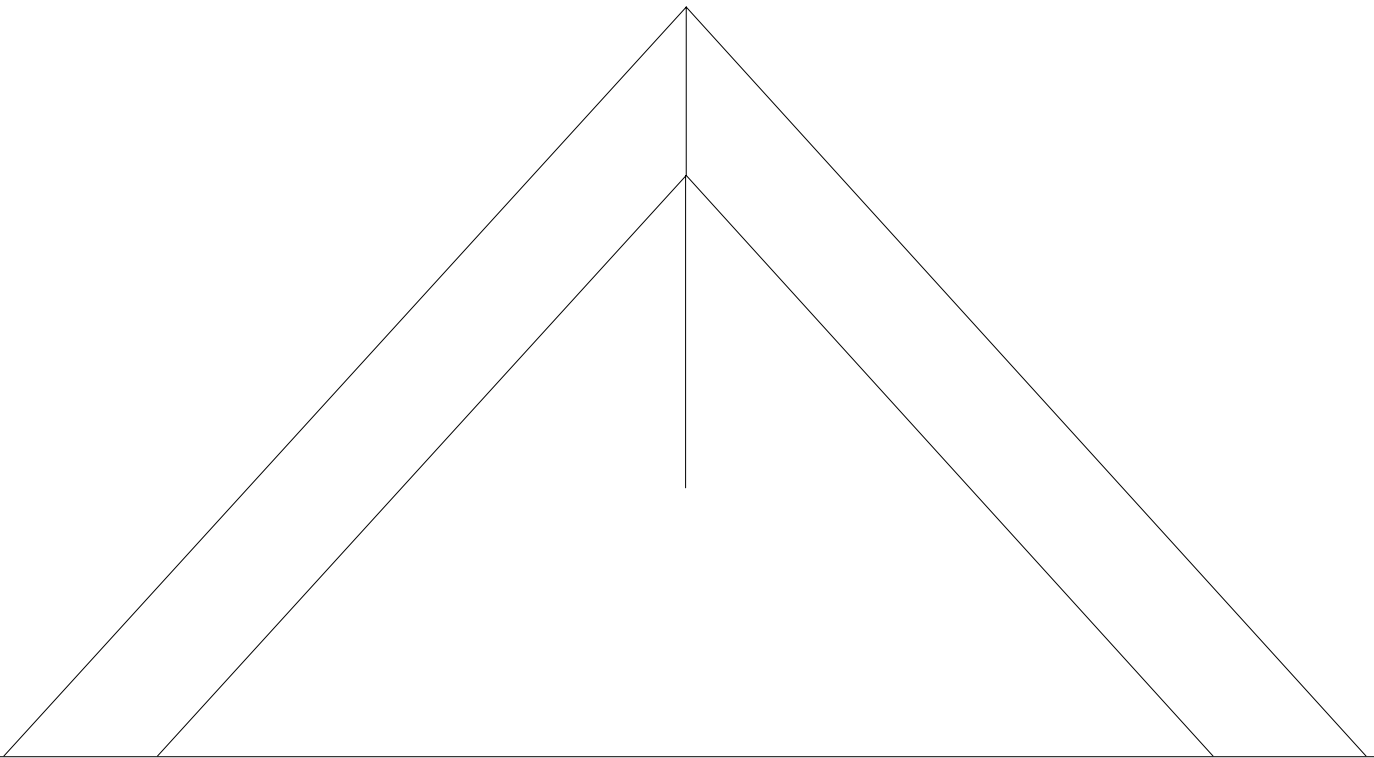

8-13

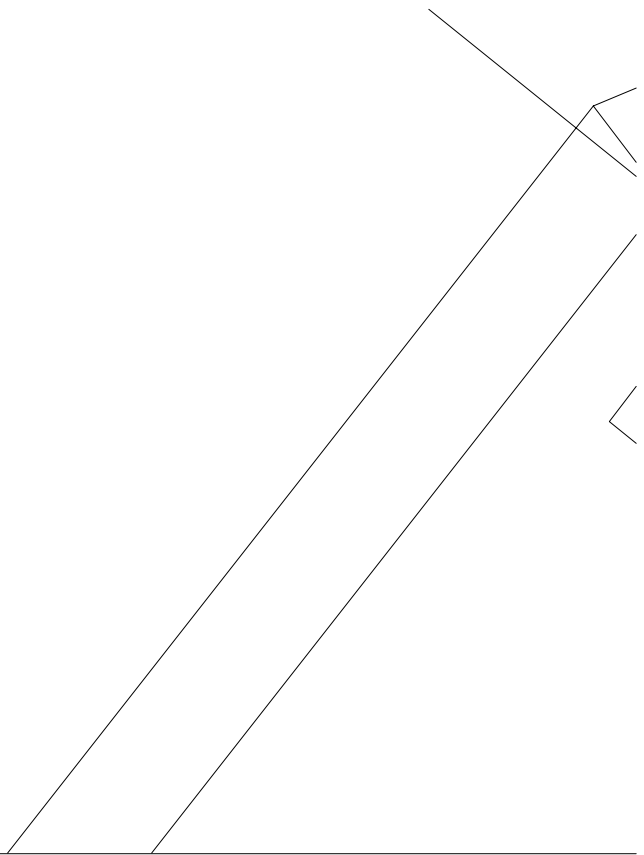

8-14

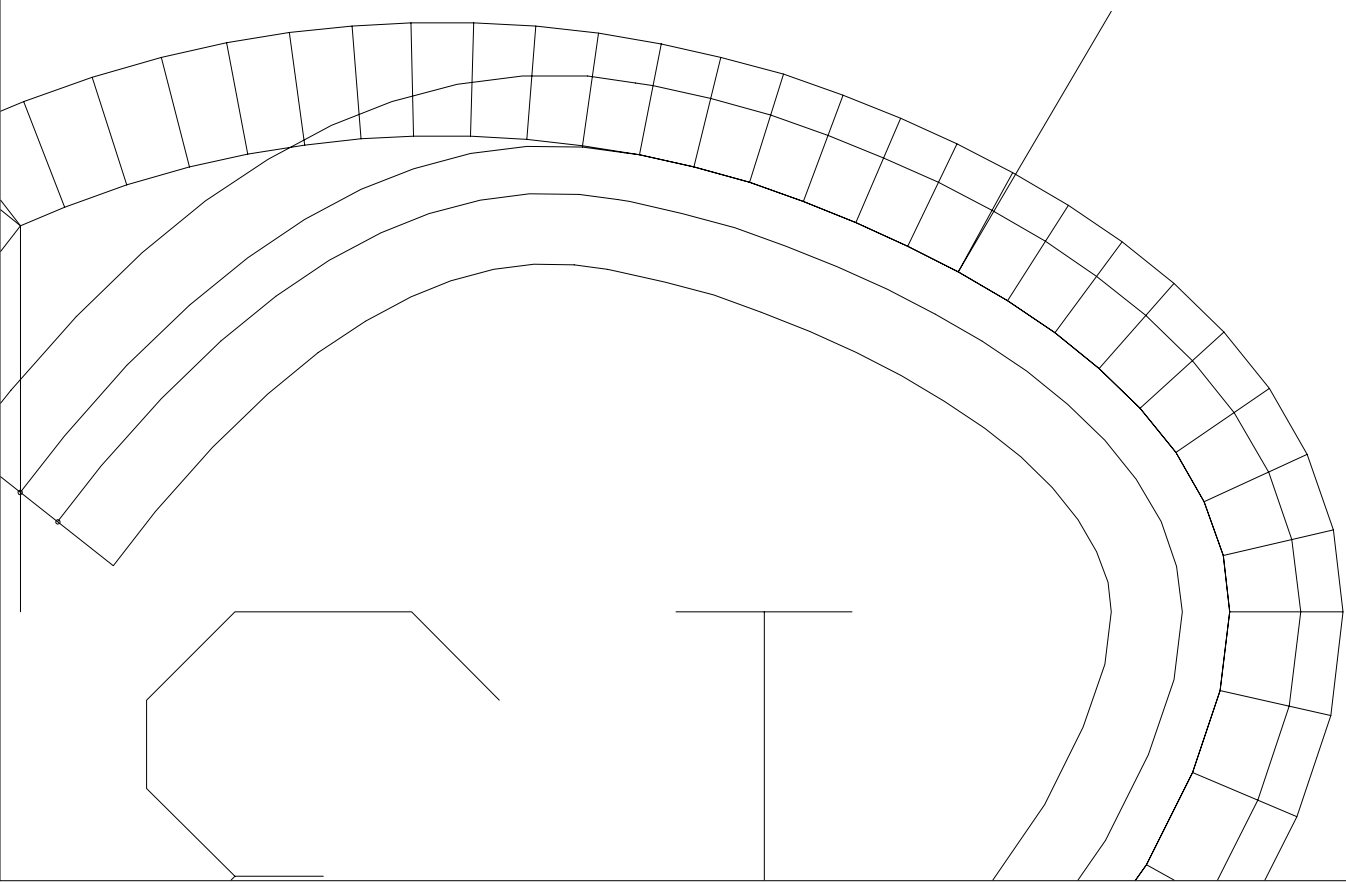

8-15

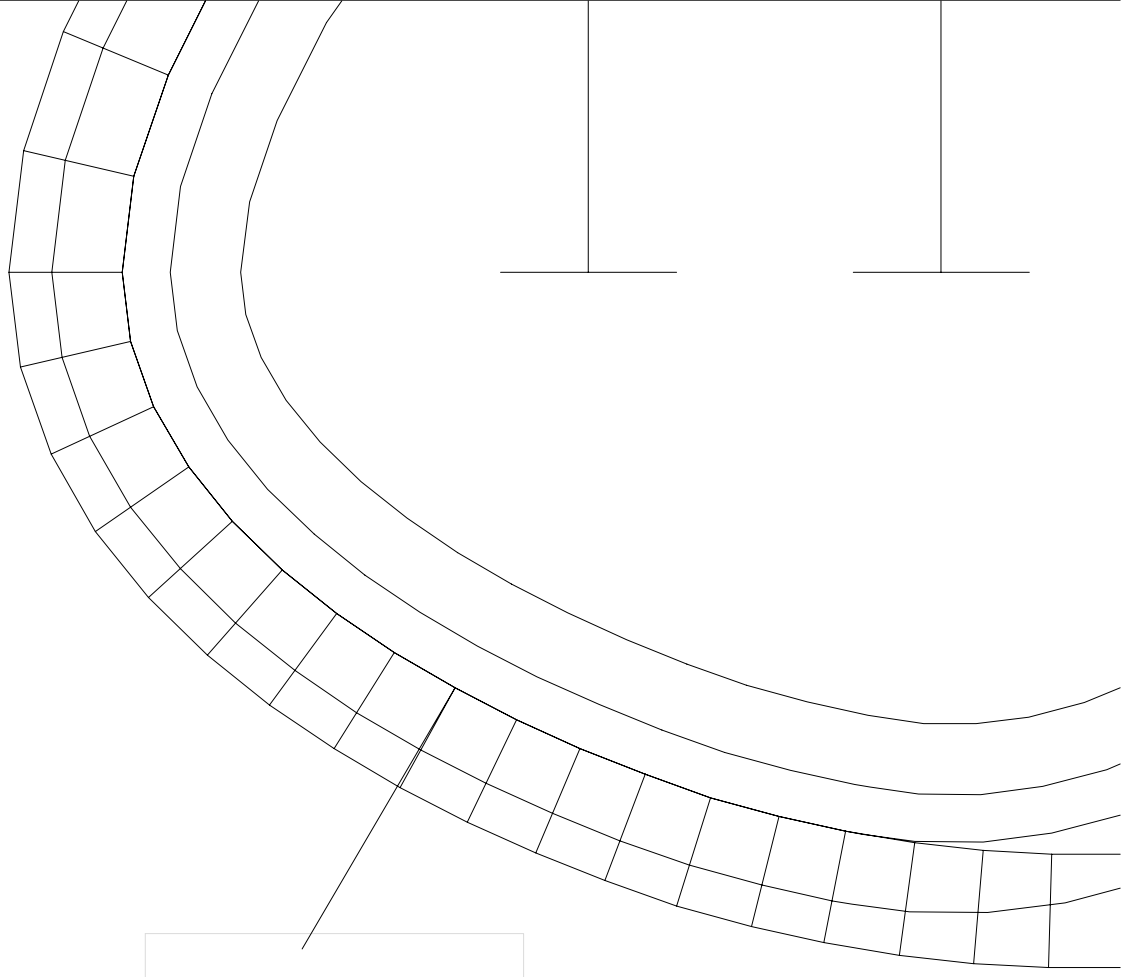

8-1

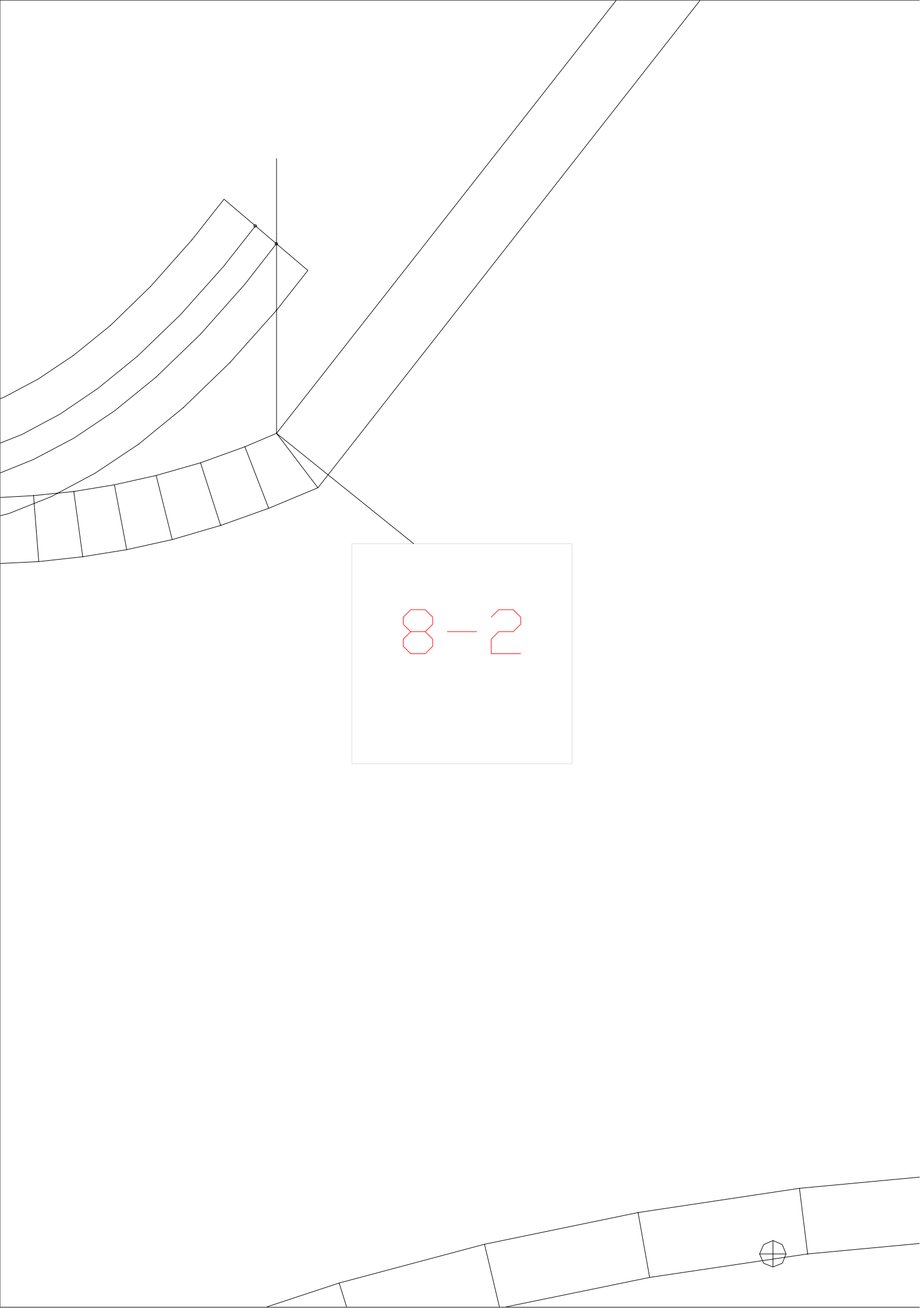

8-2



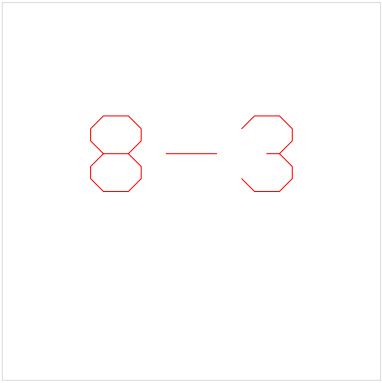

$$8 - 3$$

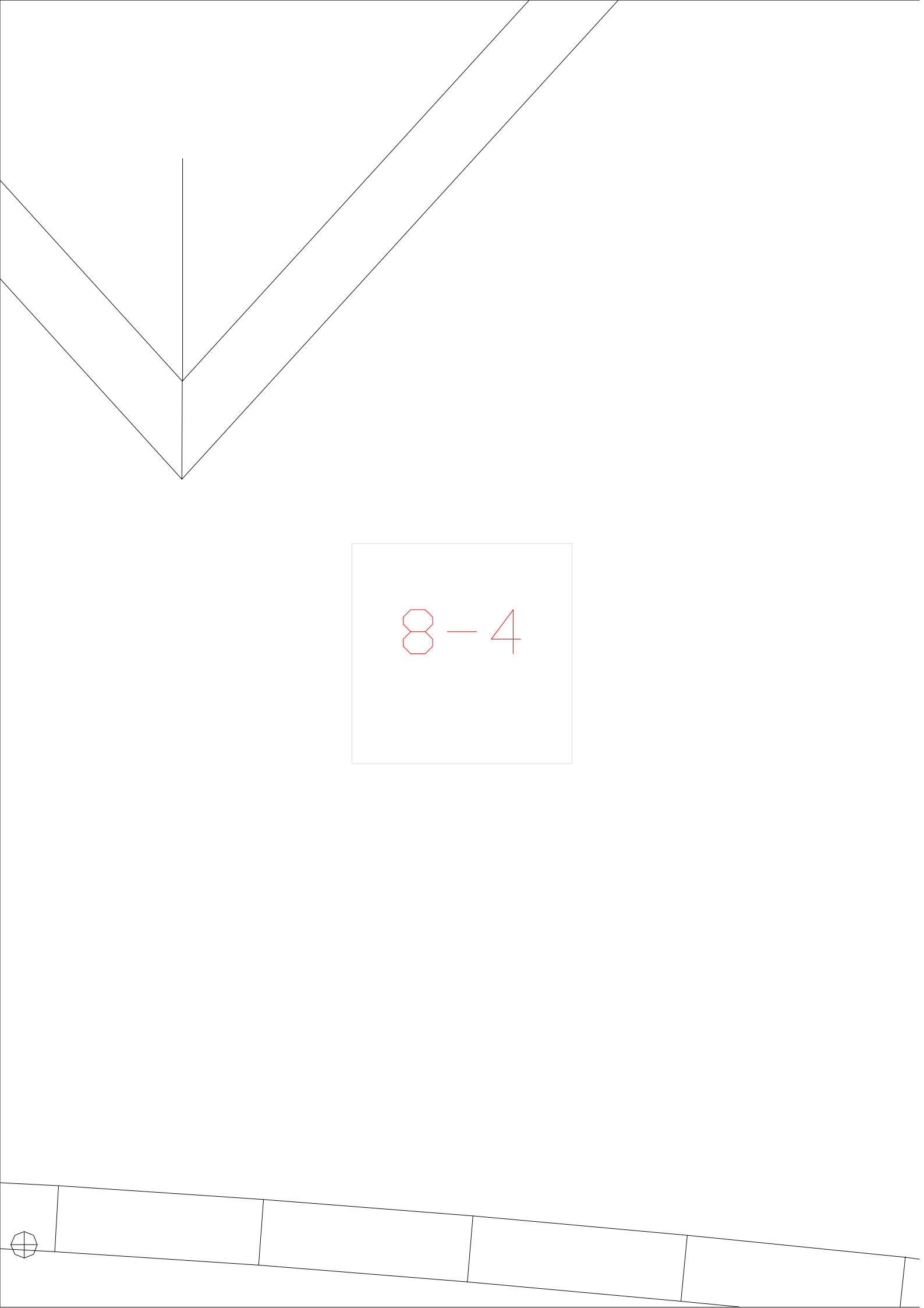
--	--	--	--	--

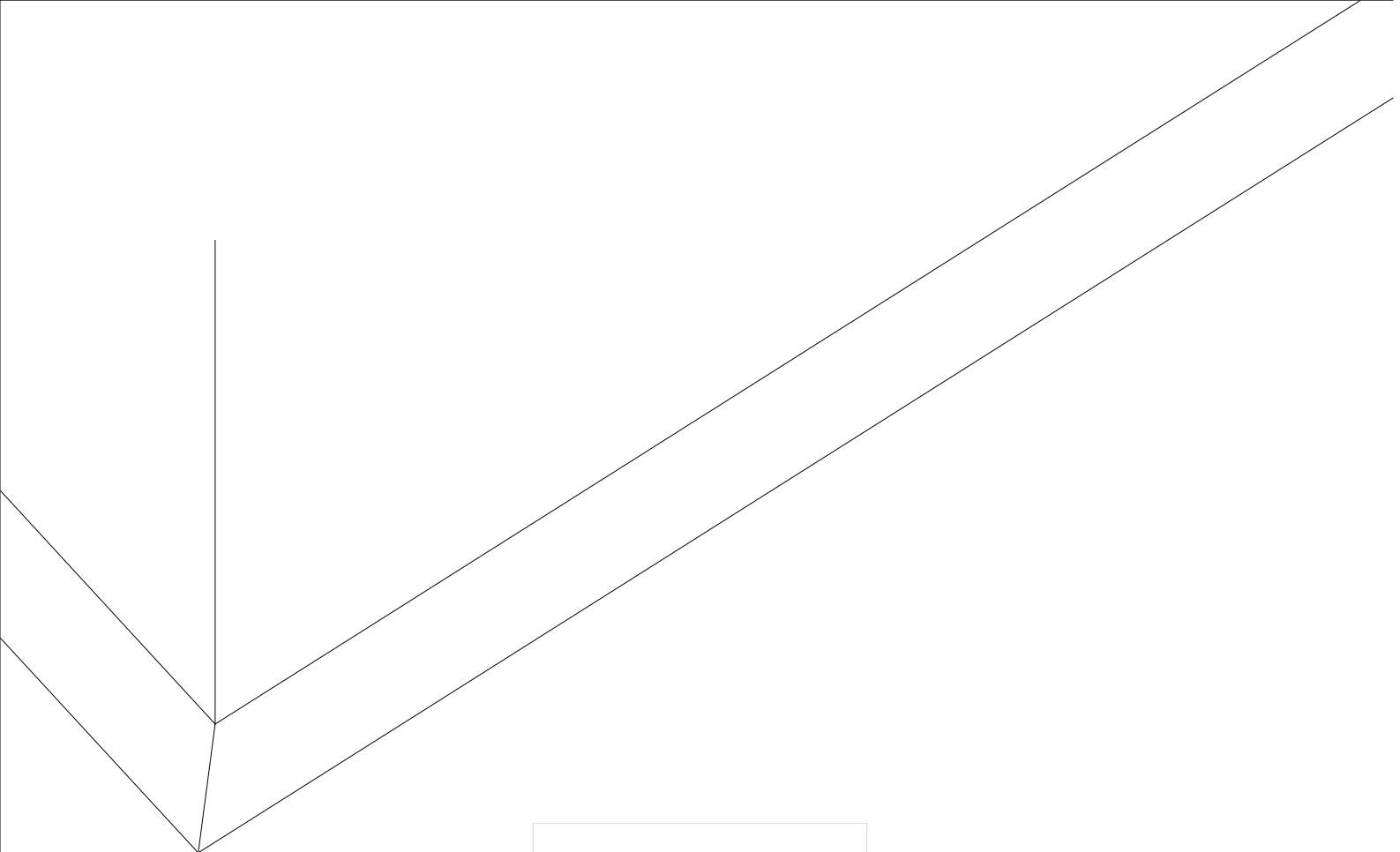

8-4

$$8 - 5$$



$$8 - 6$$

$$8 - 7$$

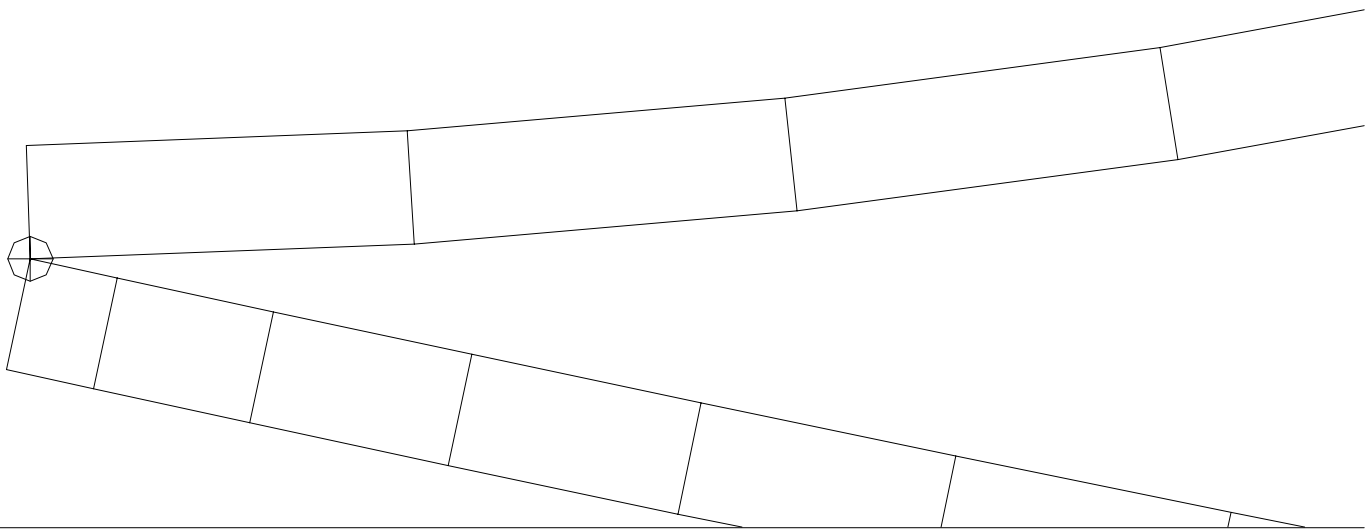

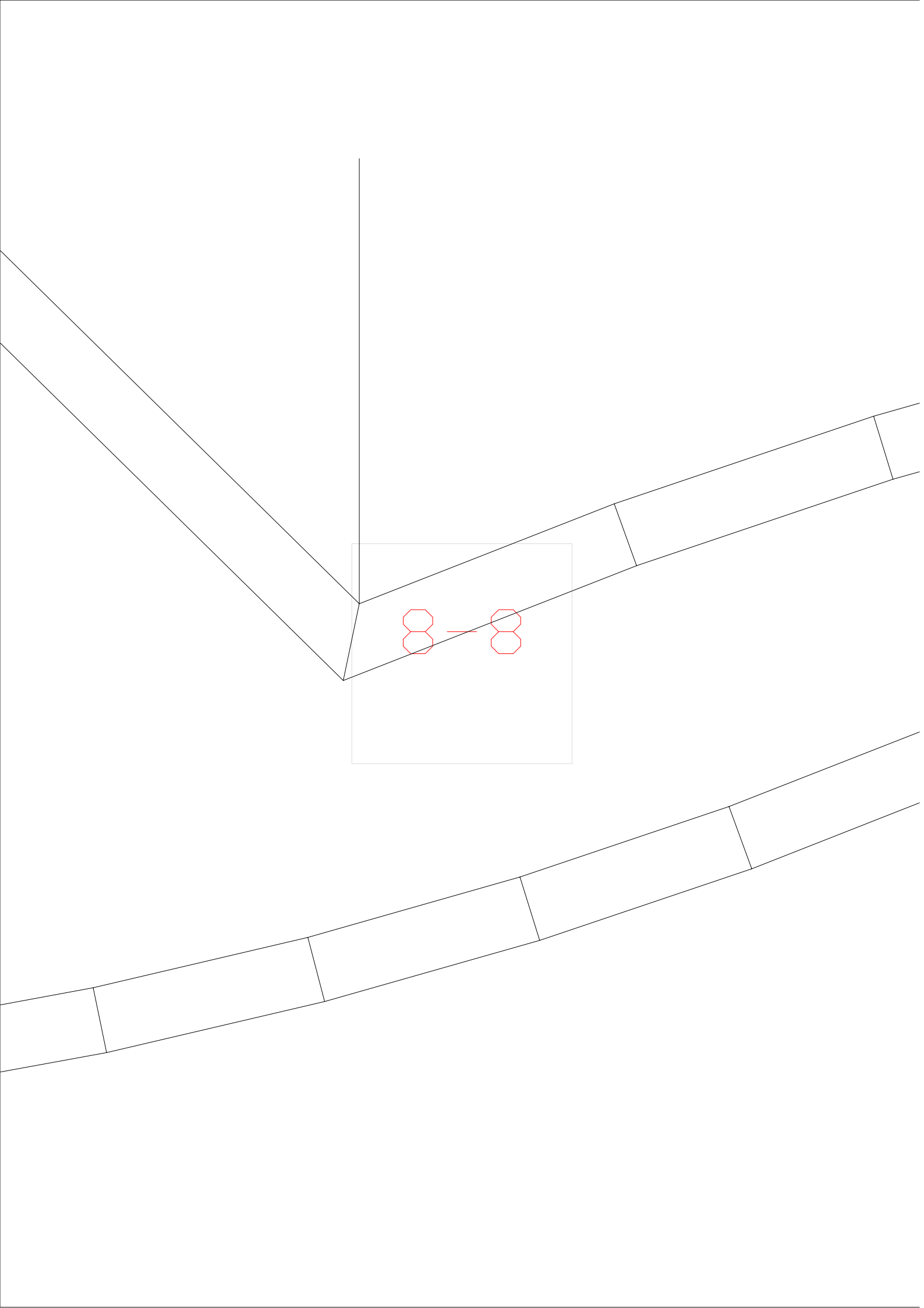

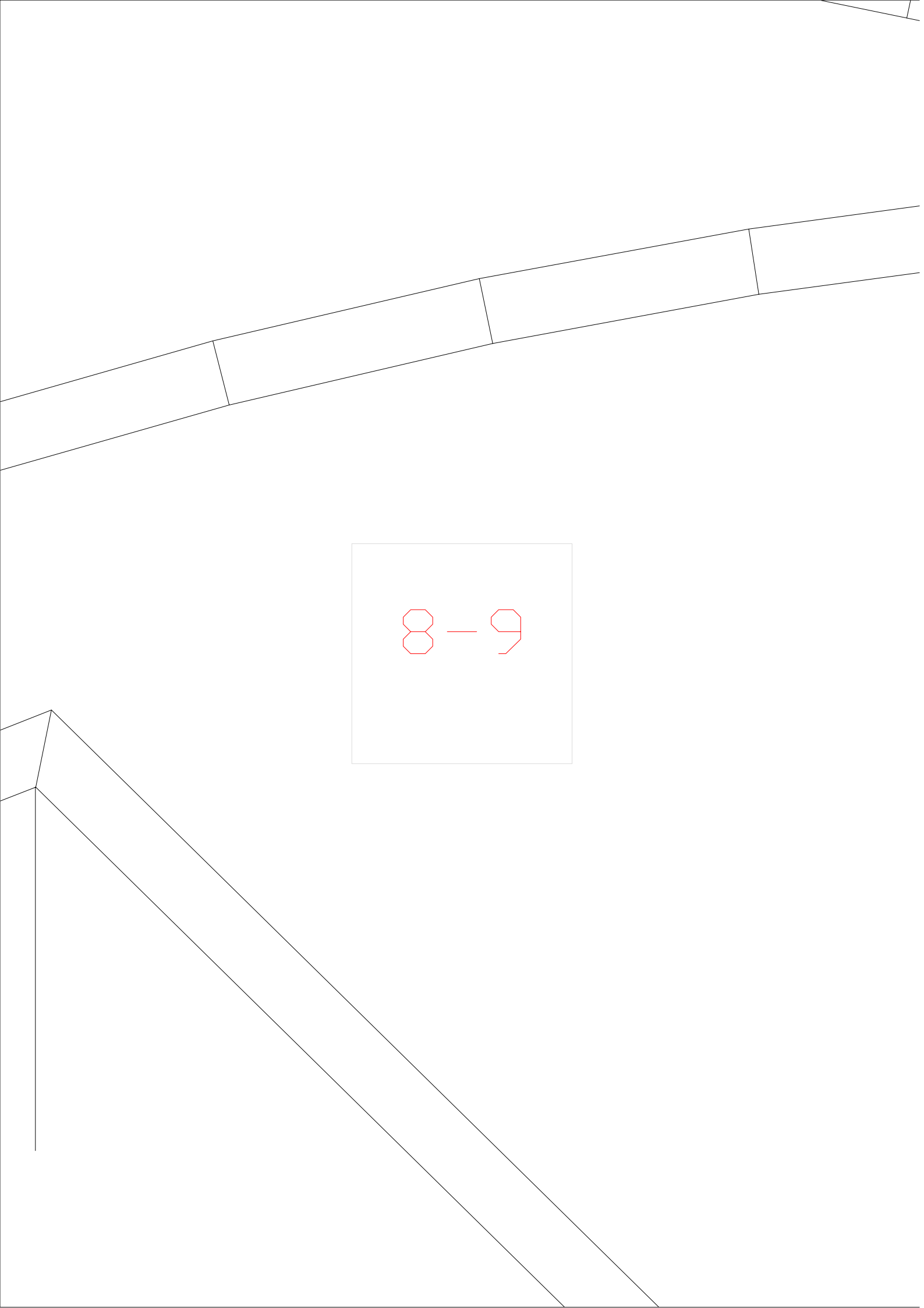

8-9

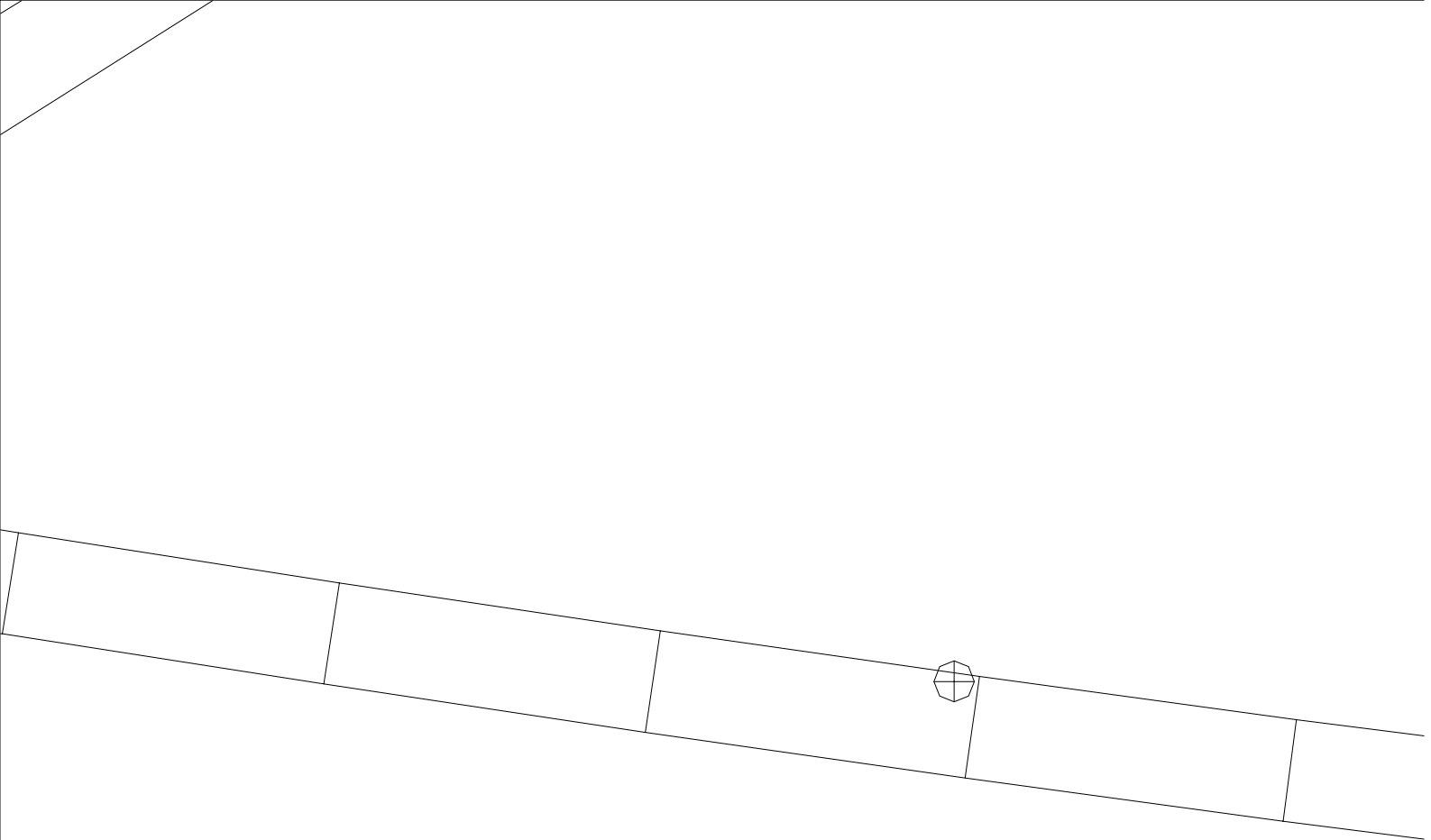

9-10

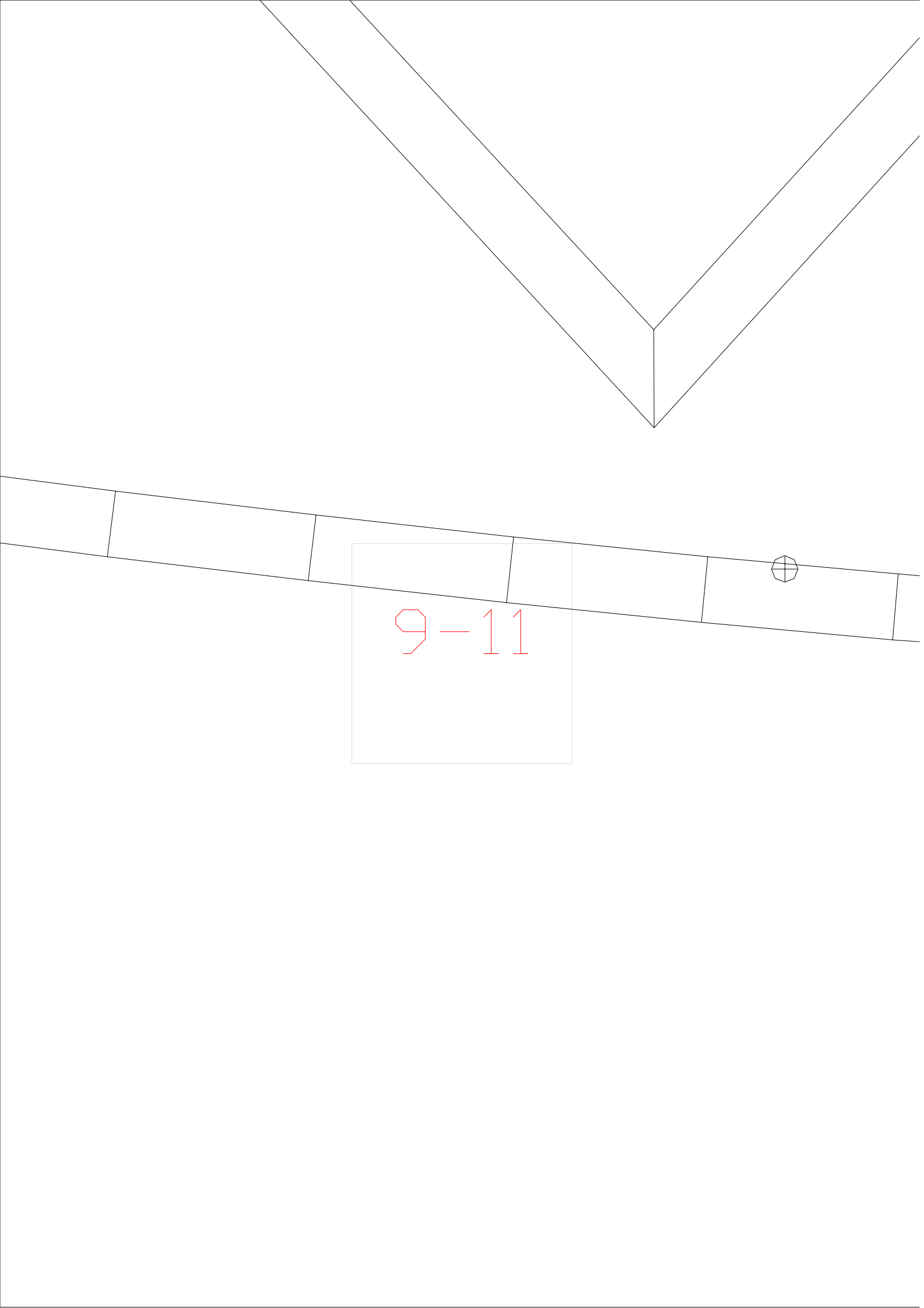

9-11

9-12

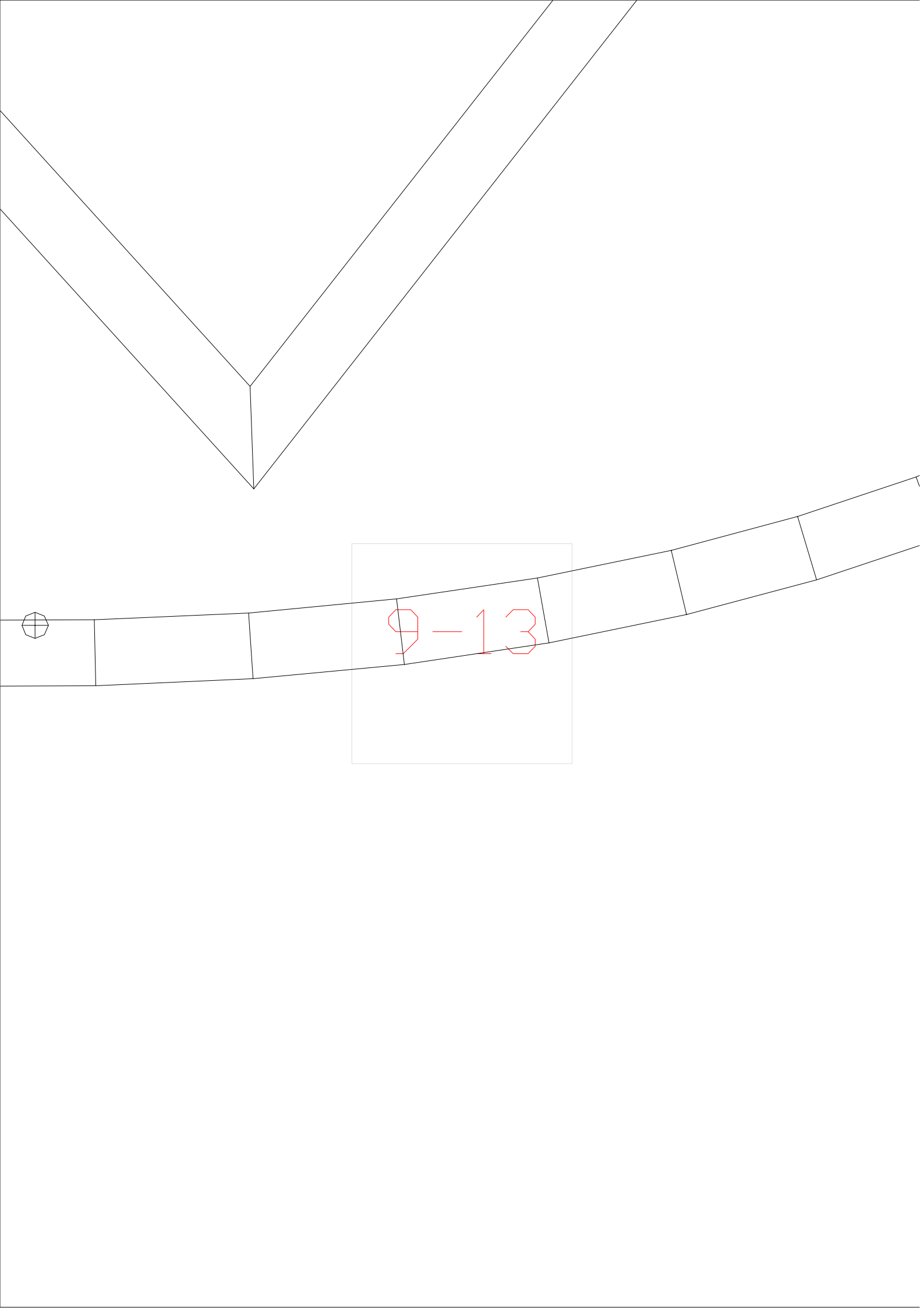

9-13

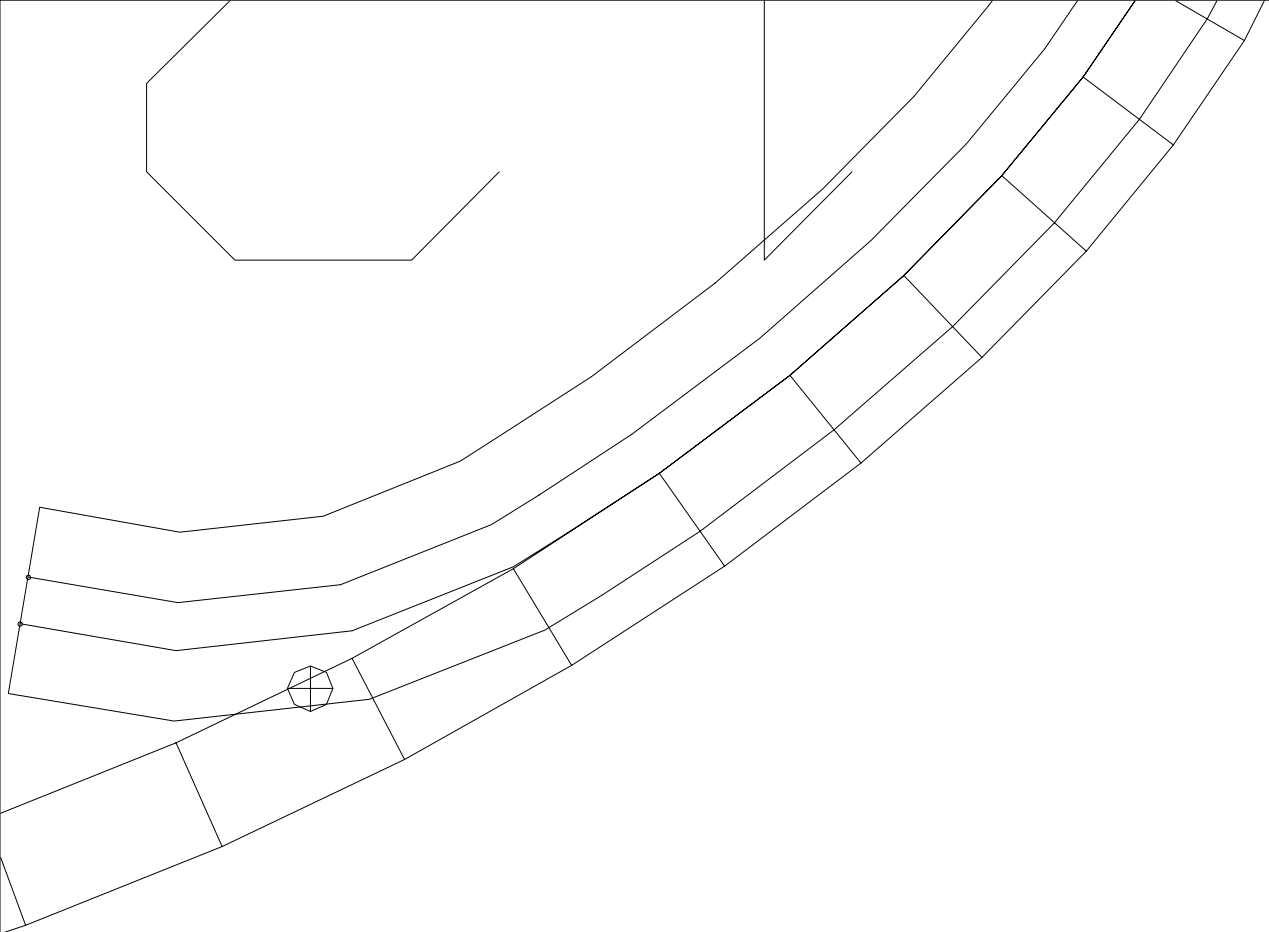

9-14

9-15

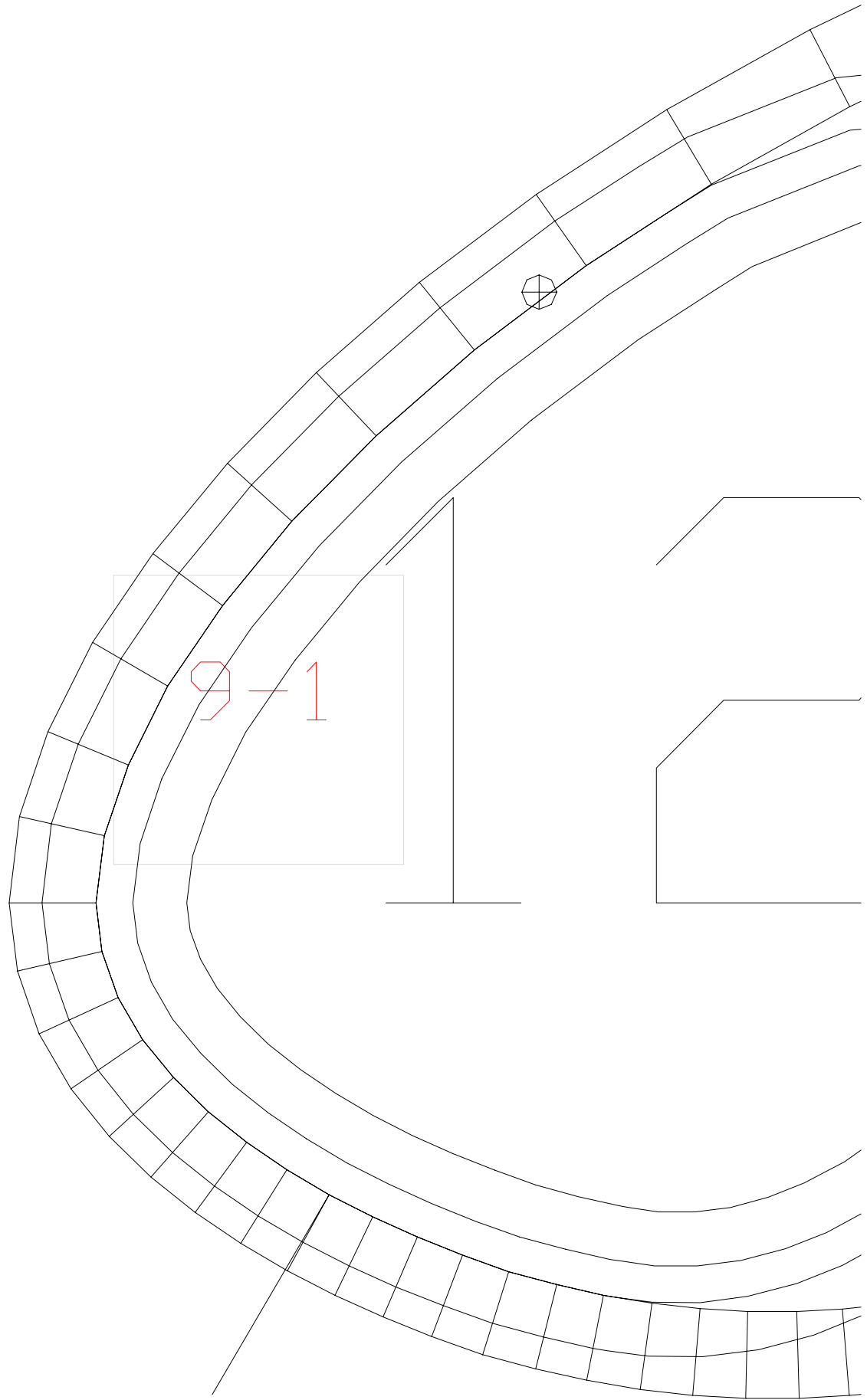

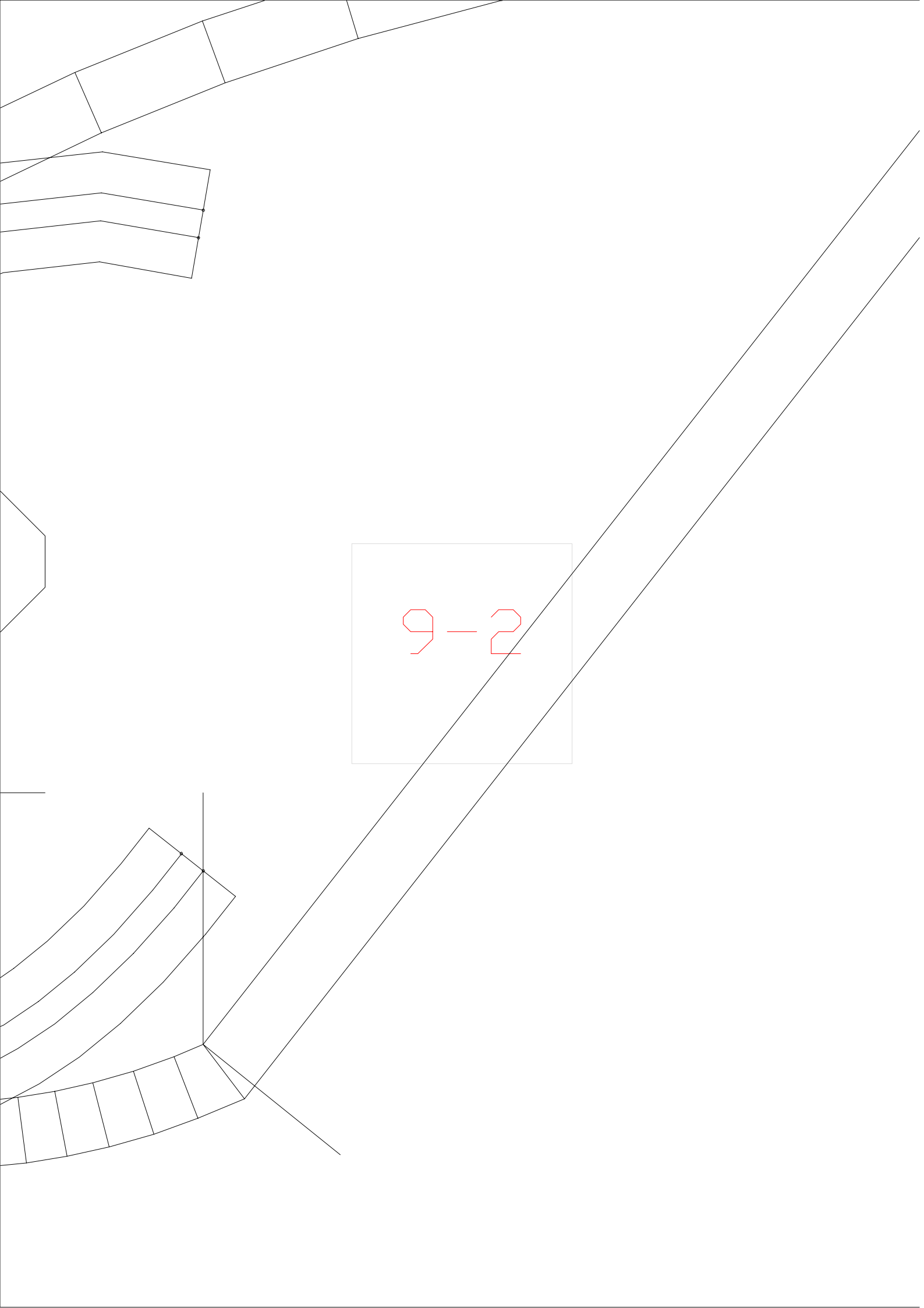

9-2

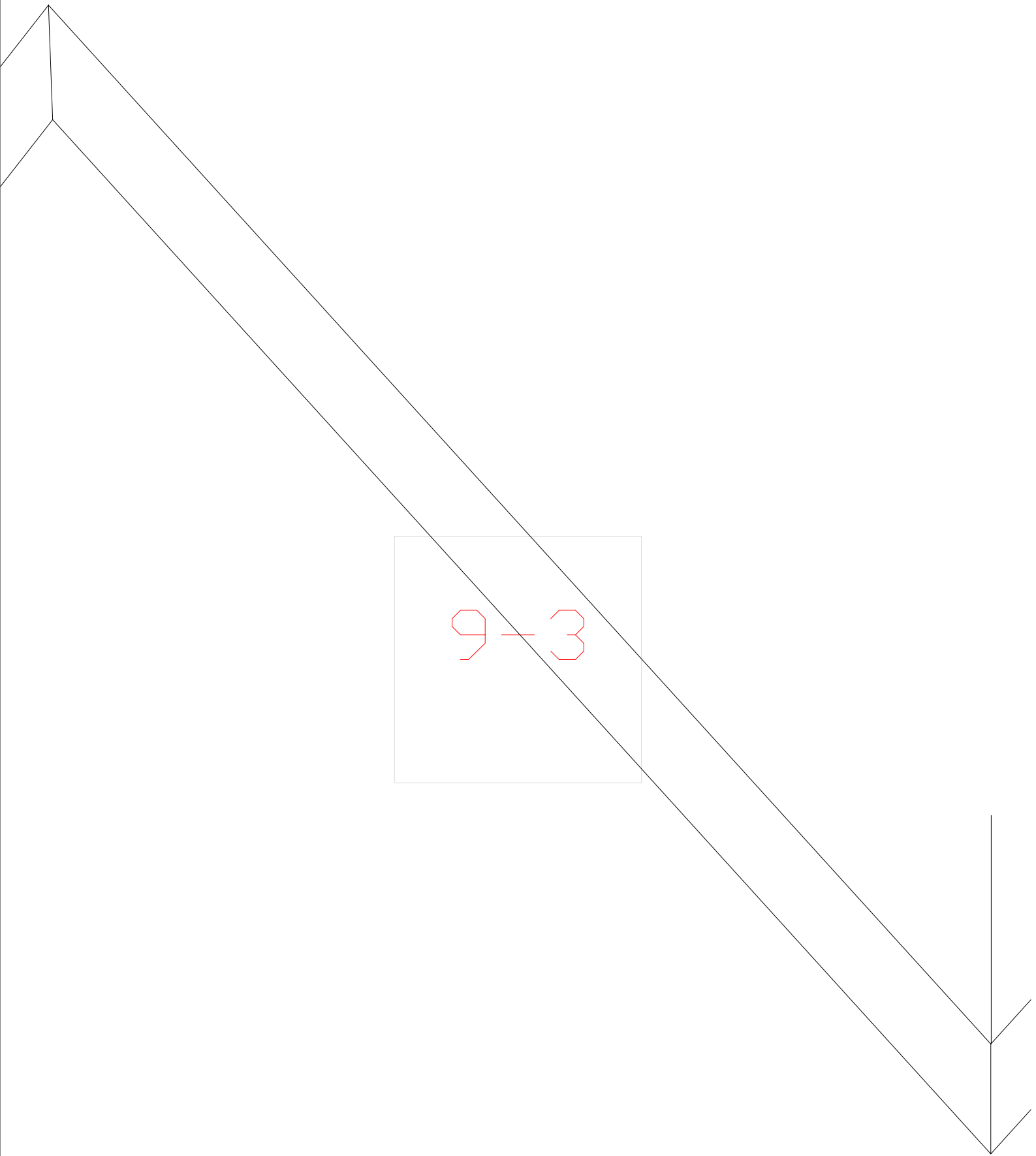

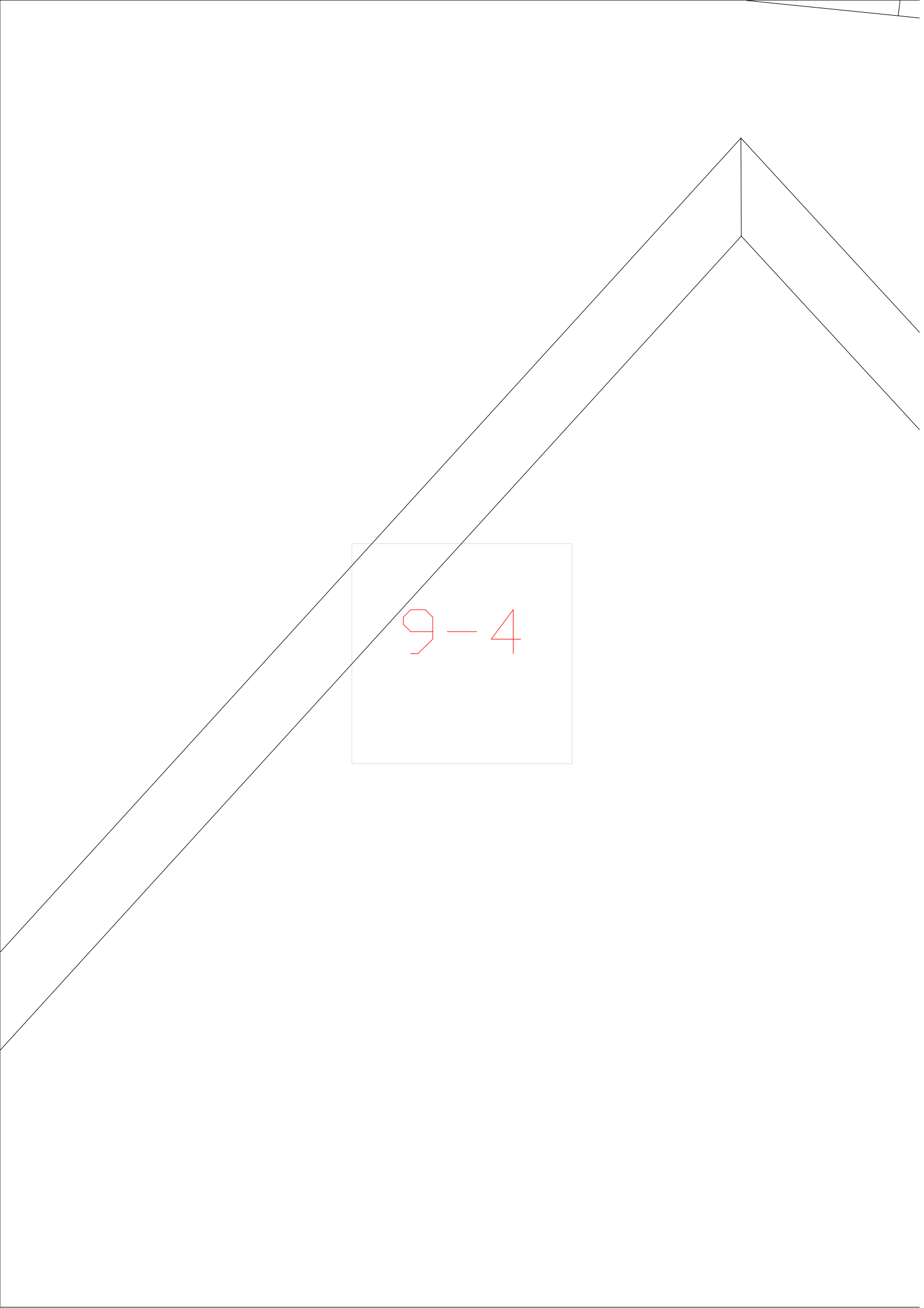

9-4

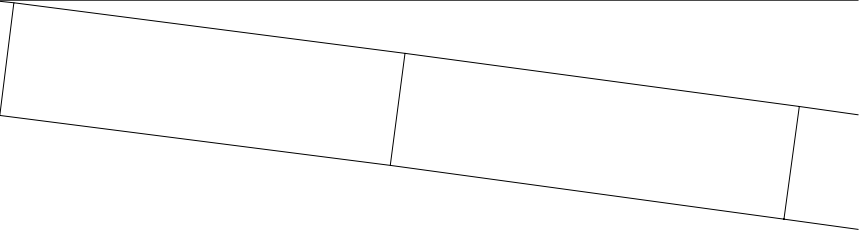

9-5

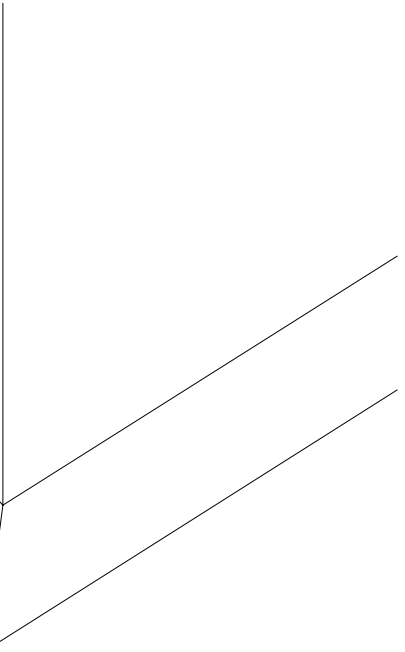

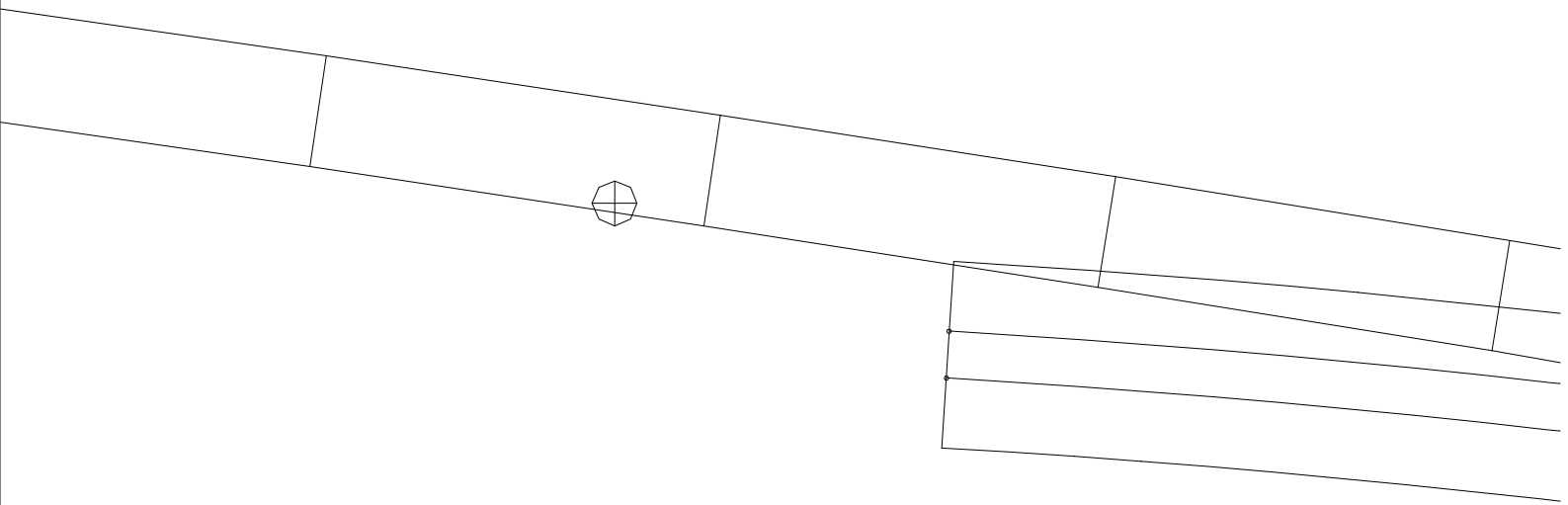

9-6

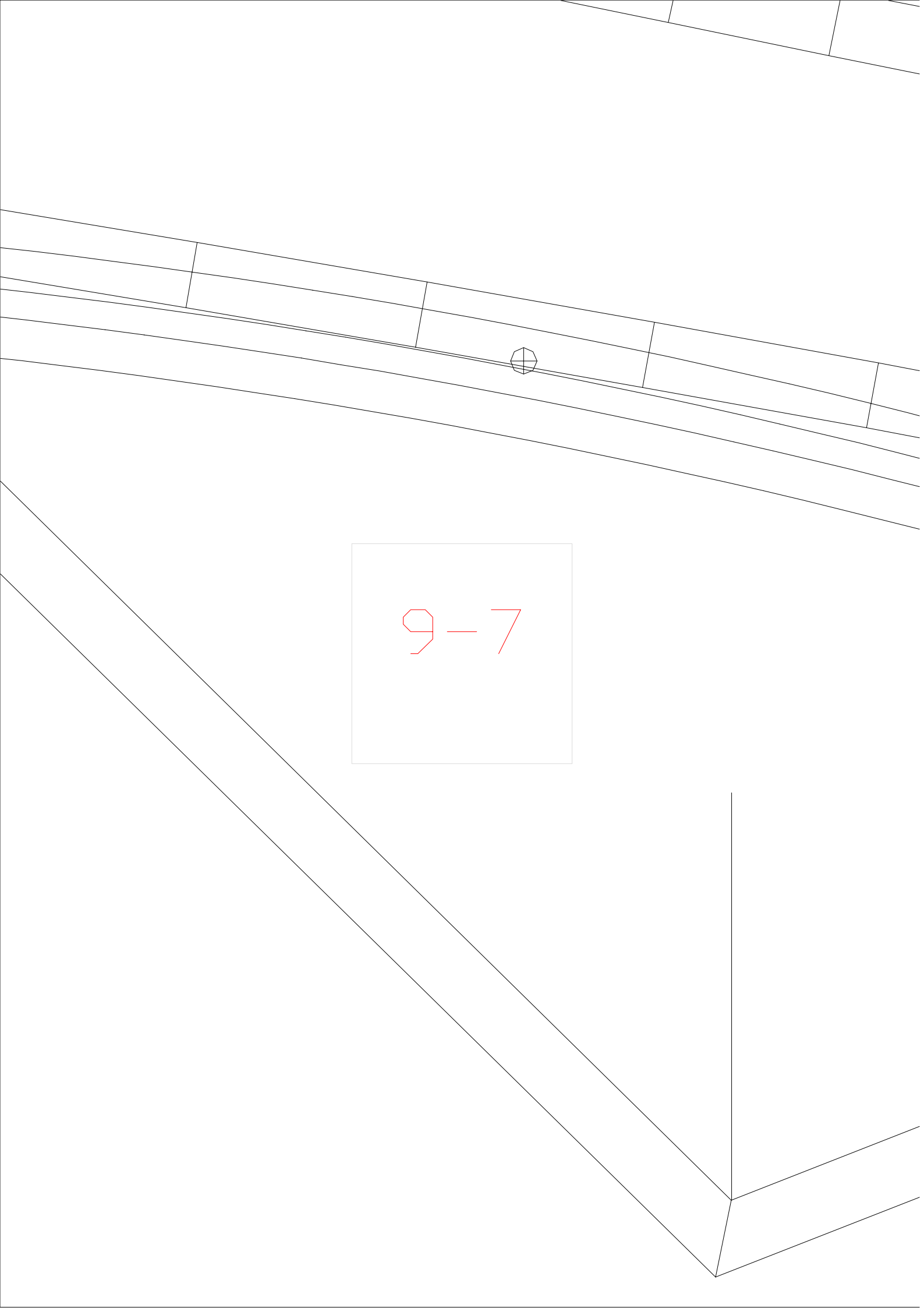

9-7

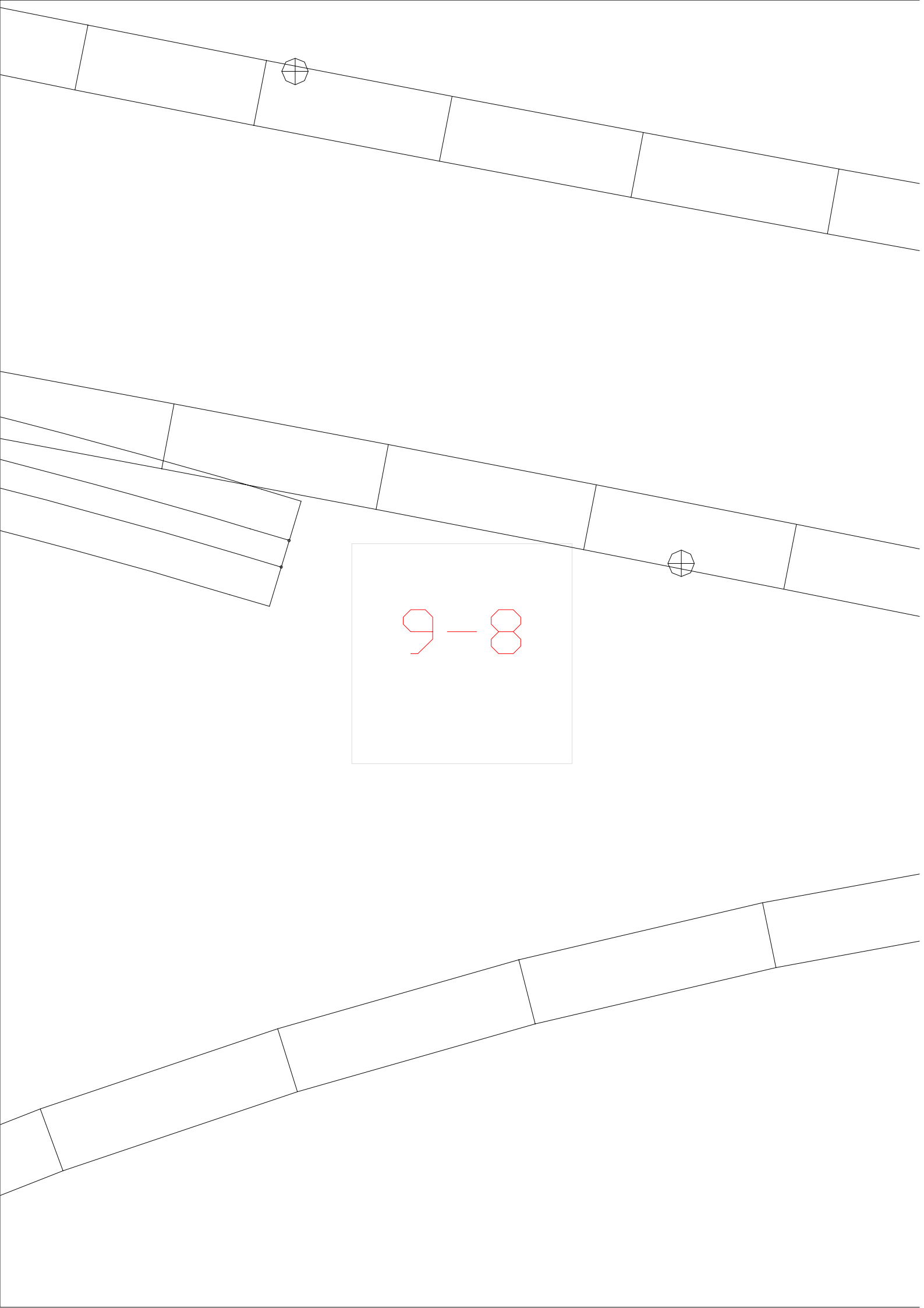

9-8

