

10-11



10-12



10-13

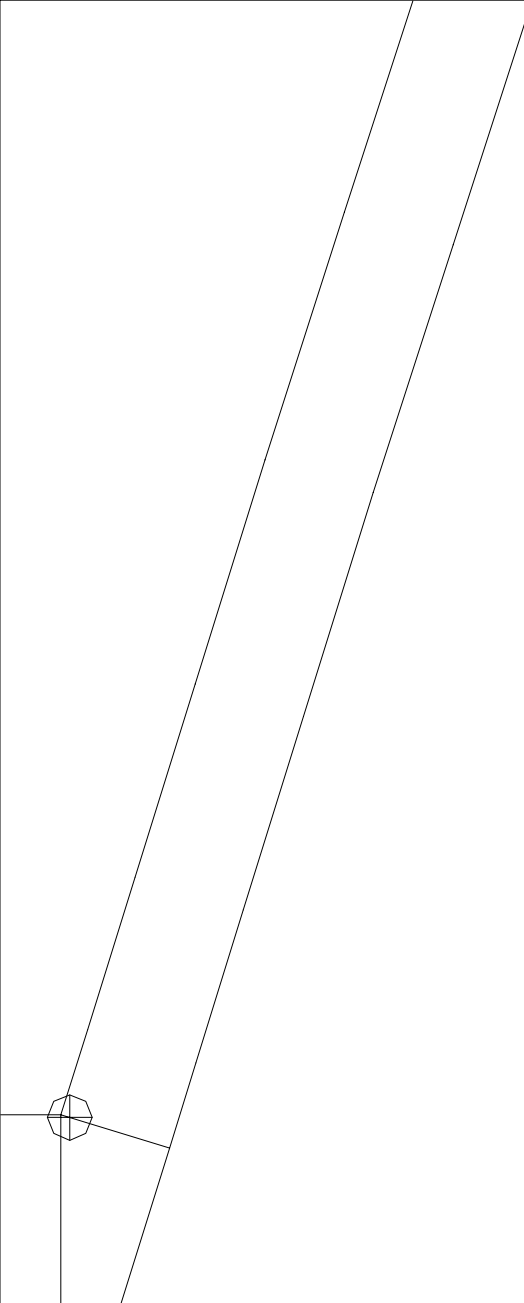

10-14

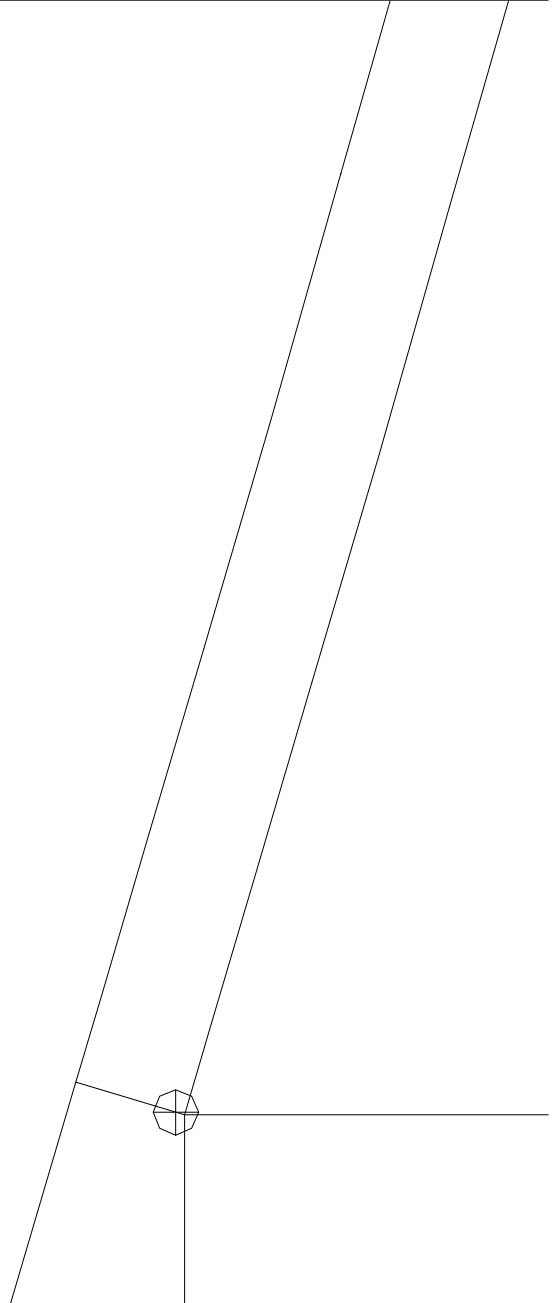

10-15

• • • • •  
• •

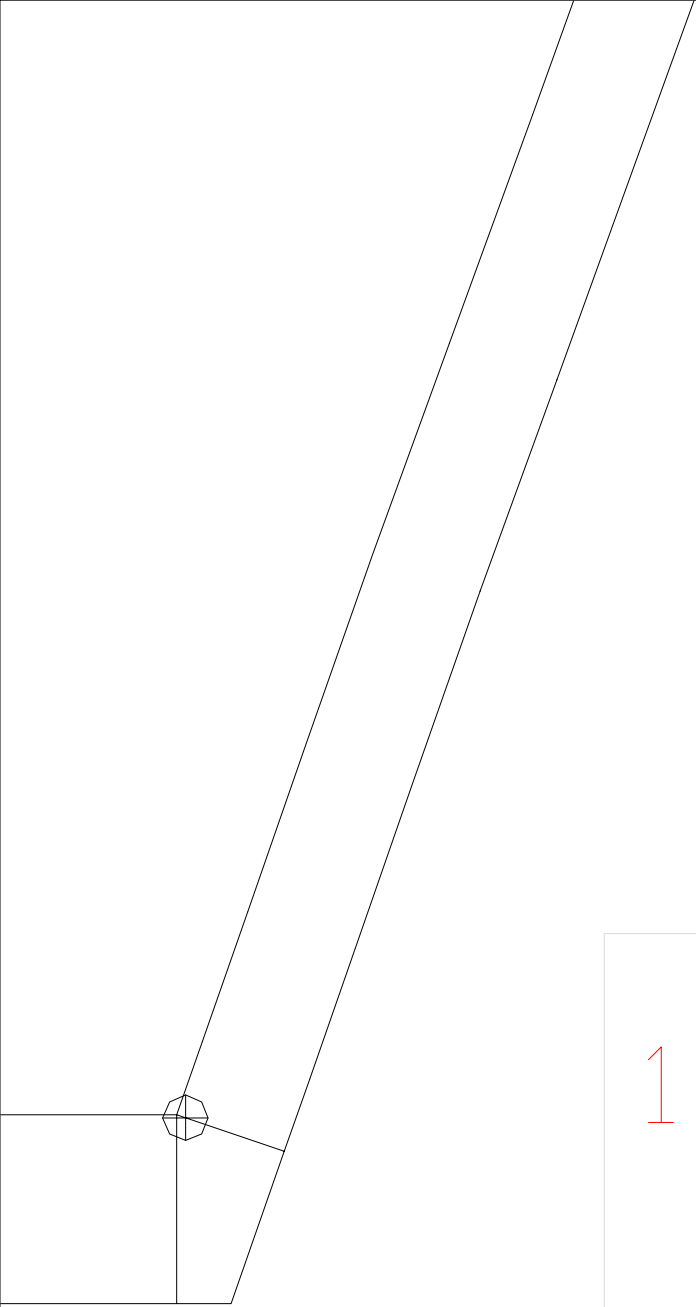

10-16

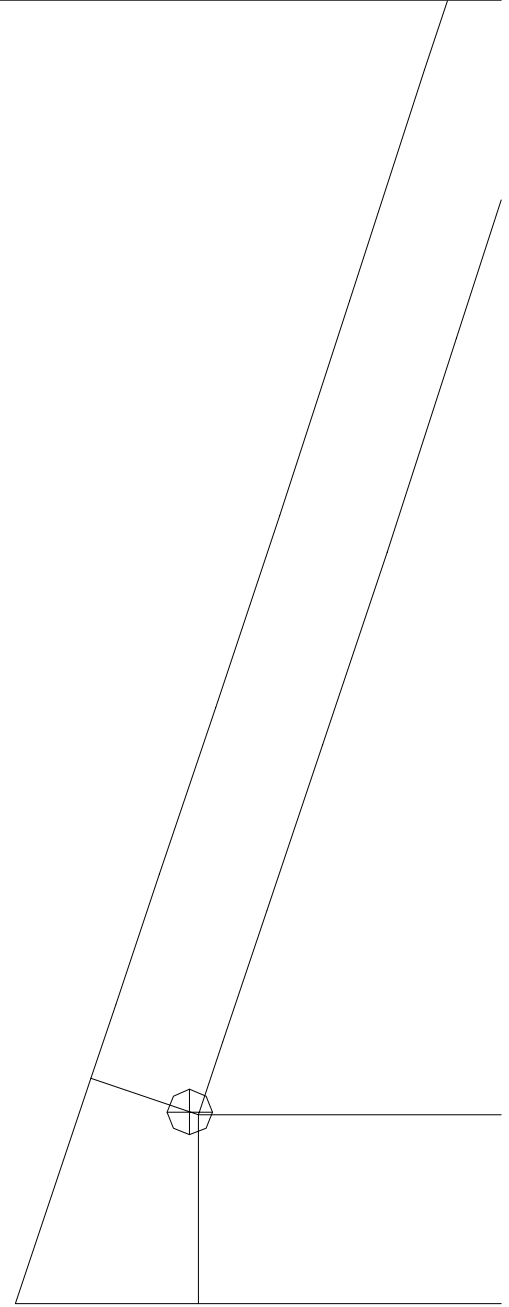



10-17

• • • •  
• • •

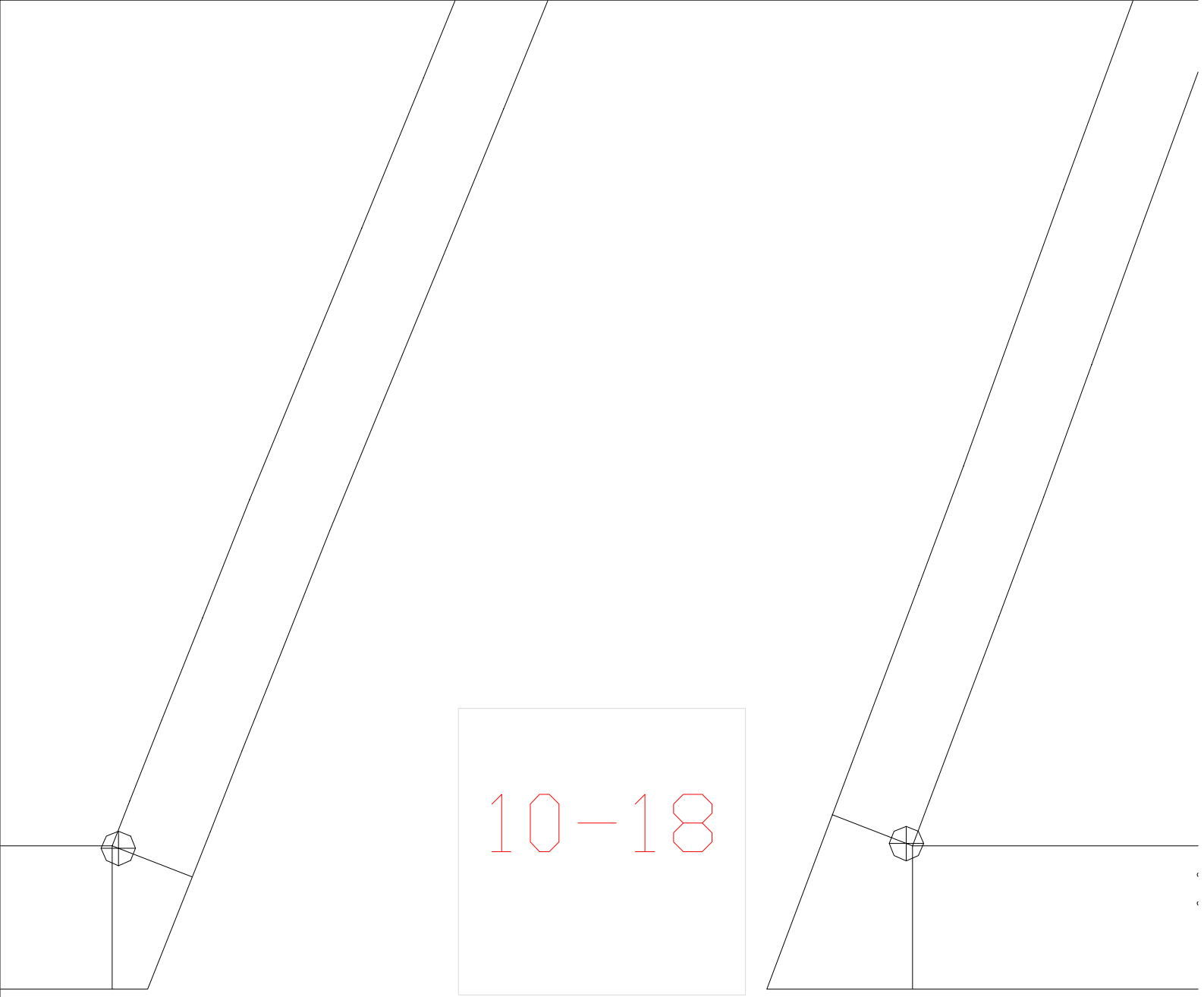

10-18

10-19

• • • •  
• •

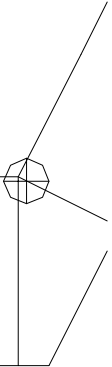

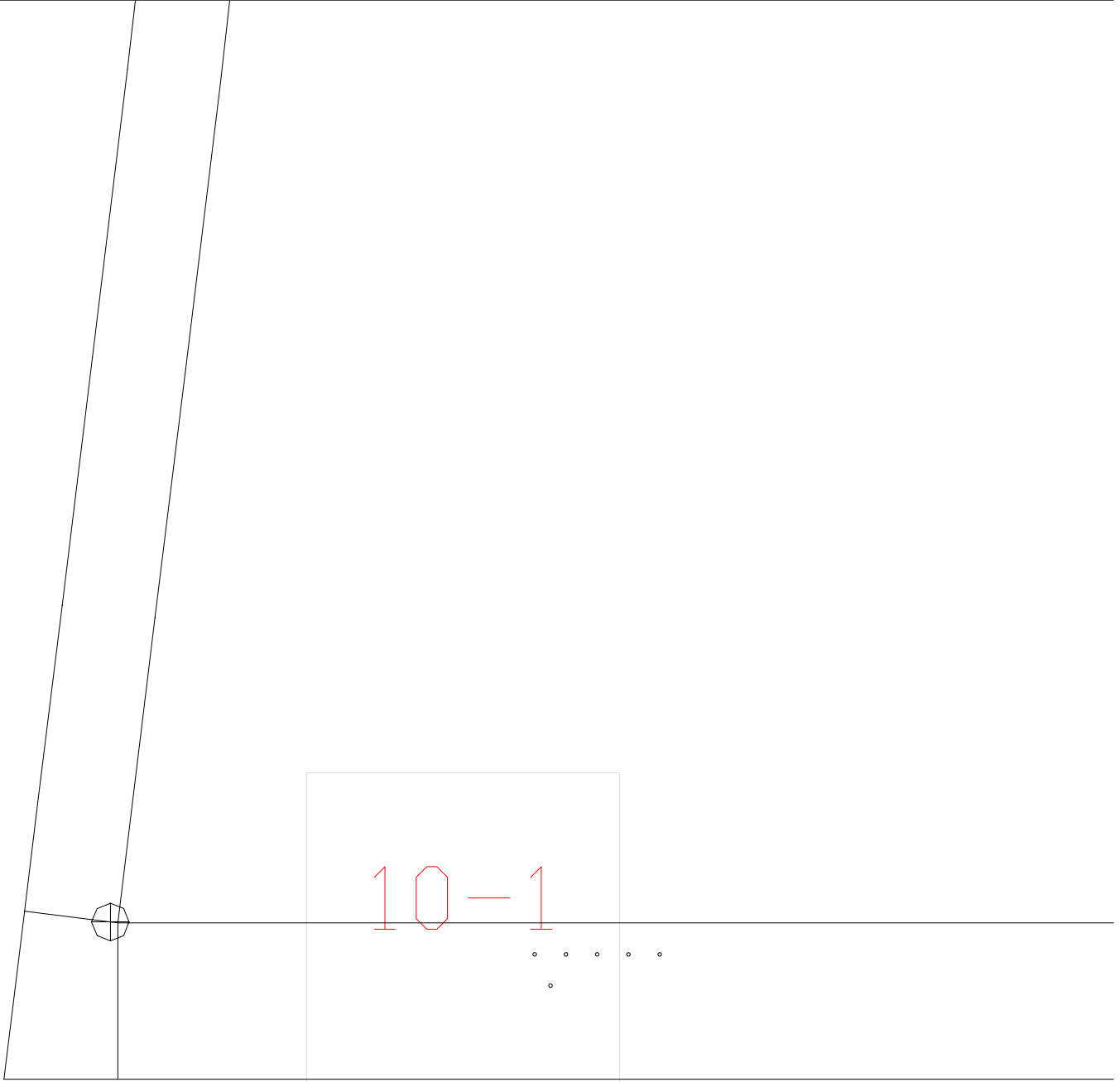

10-1

• • • • •  
•

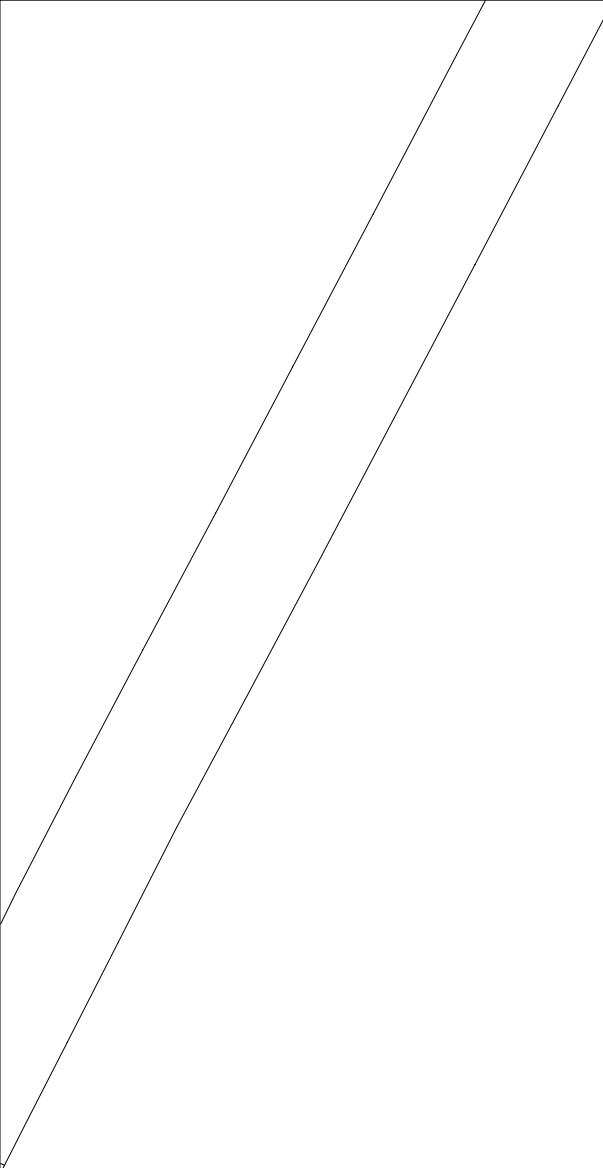

10-20

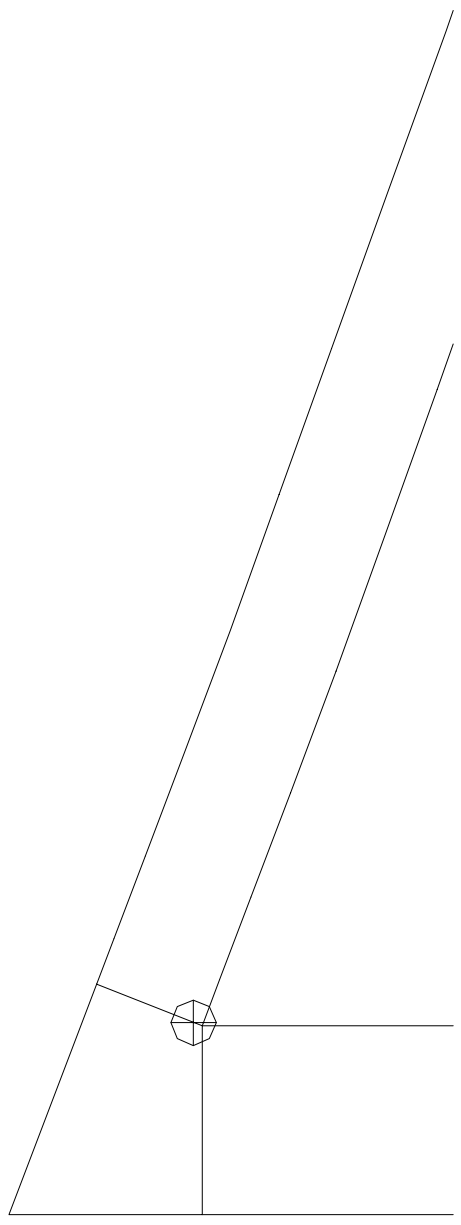

10-21

• • • • •  
• • •

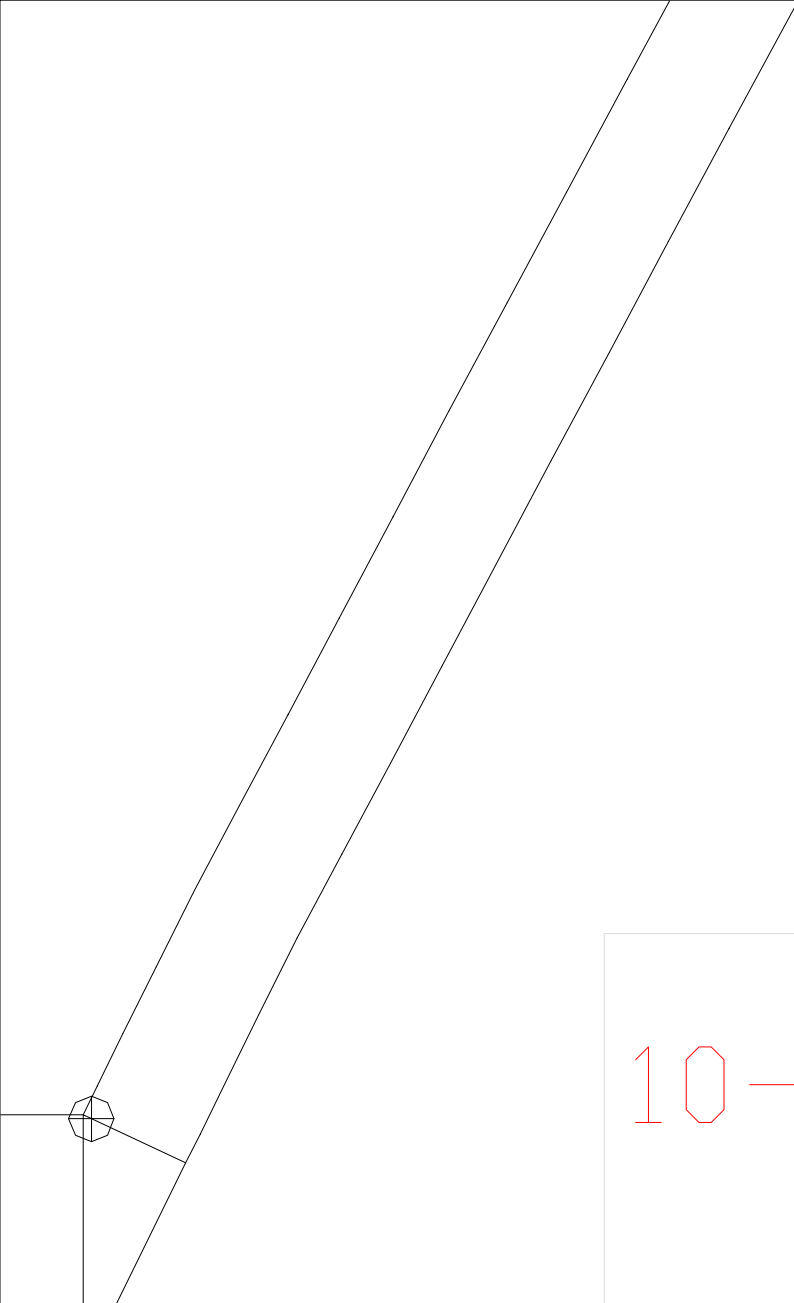

10-22

10-23



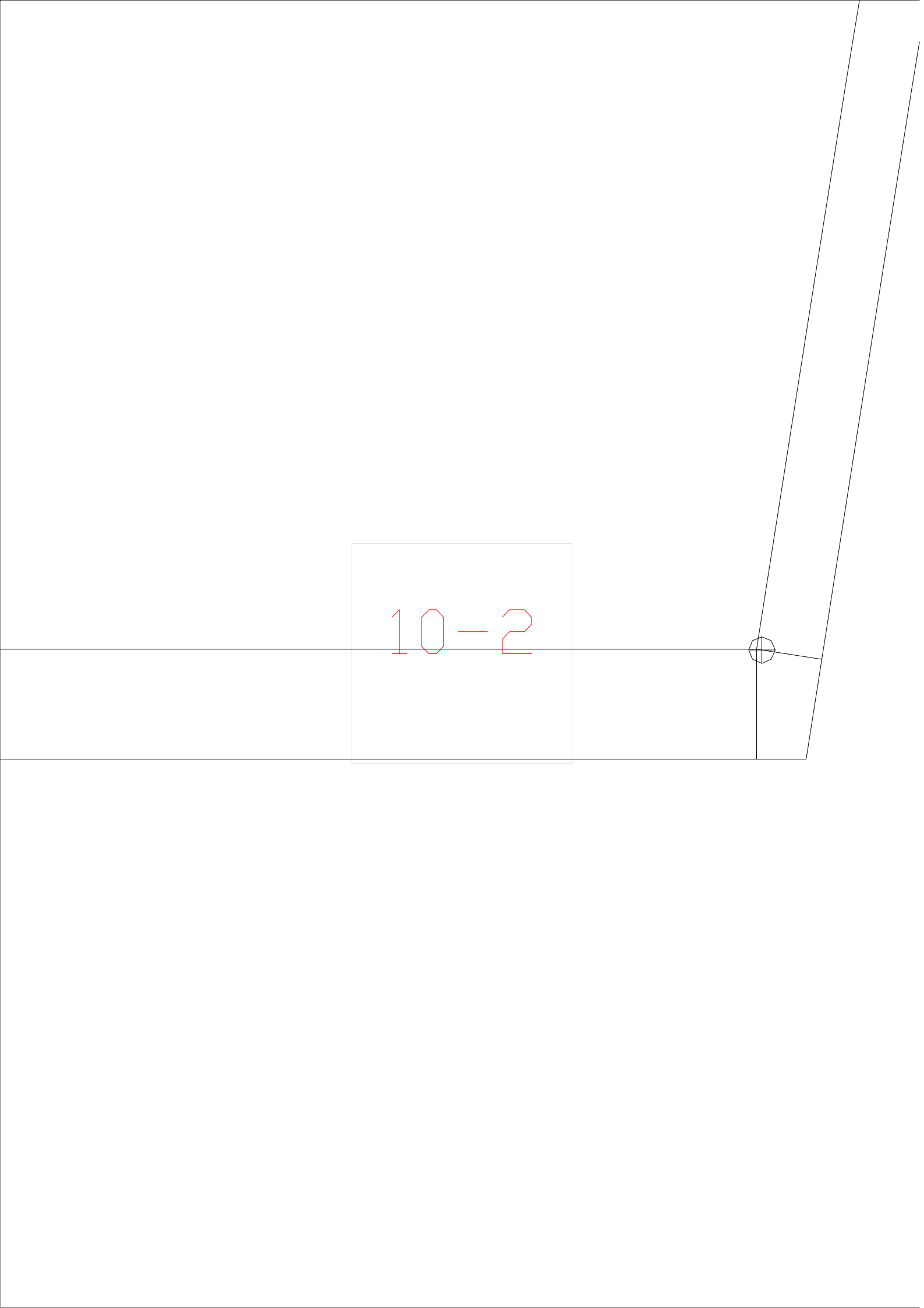

A technical drawing of a mechanical part. The part consists of a horizontal cylindrical section on the left and a tapered section on the right. A hole is located in the tapered section, centered vertically. A chamfered edge is present at the transition between the two sections. A light blue rectangular box highlights the text '10-2' on the horizontal section. A vertical line extends from the hole to the bottom edge of the drawing.

10-2

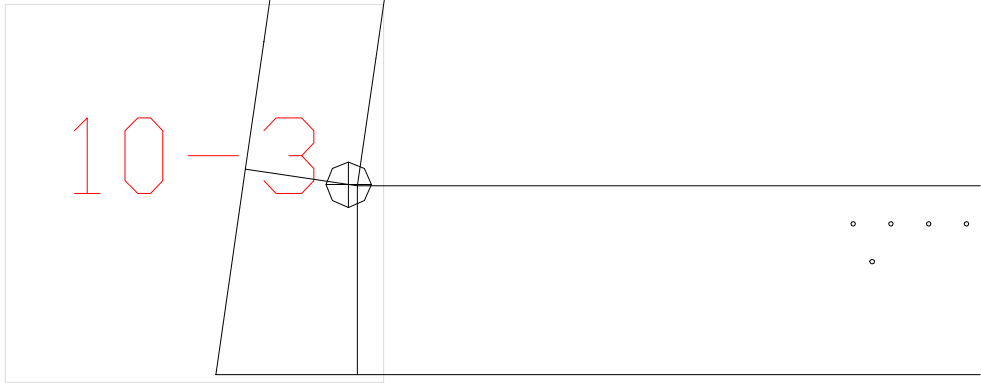

$$10 - 4$$

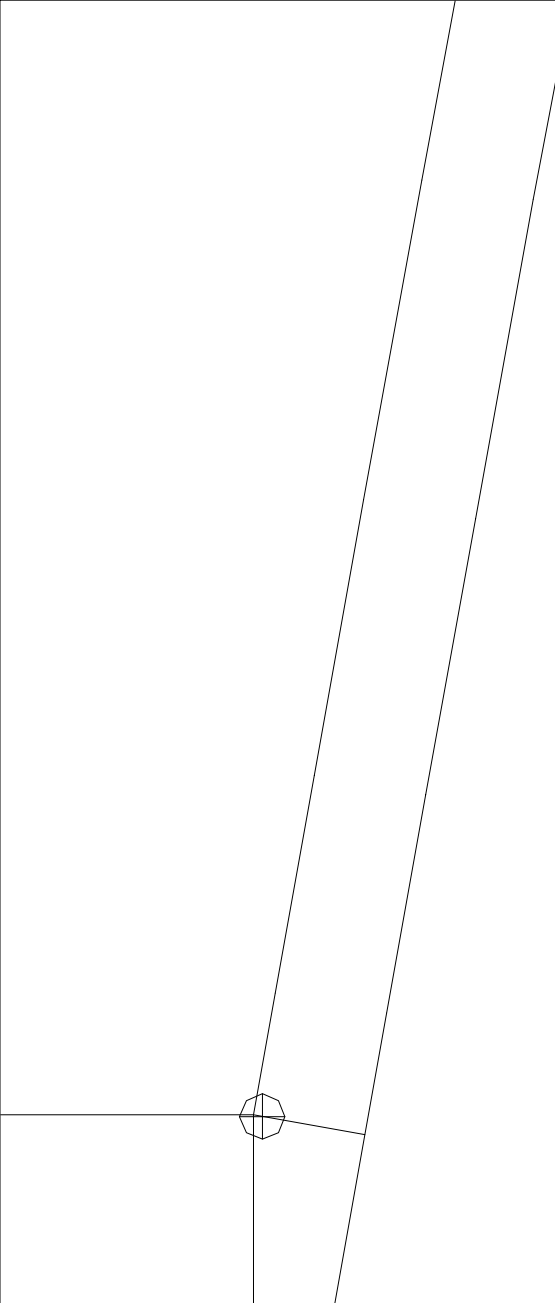

10-5

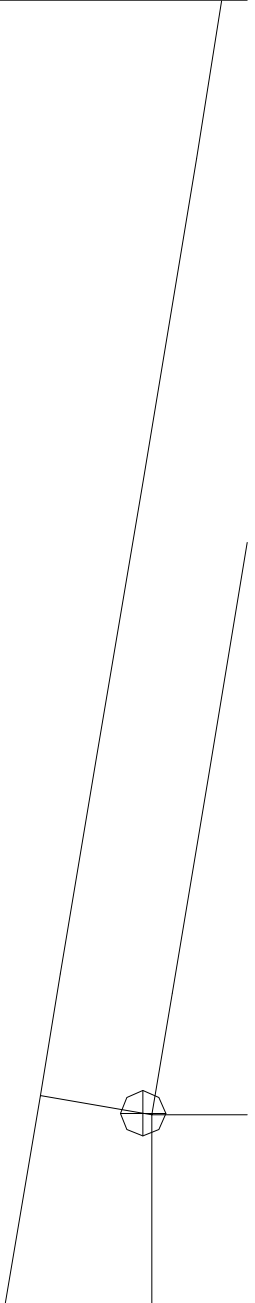

10-6

• •  
• •

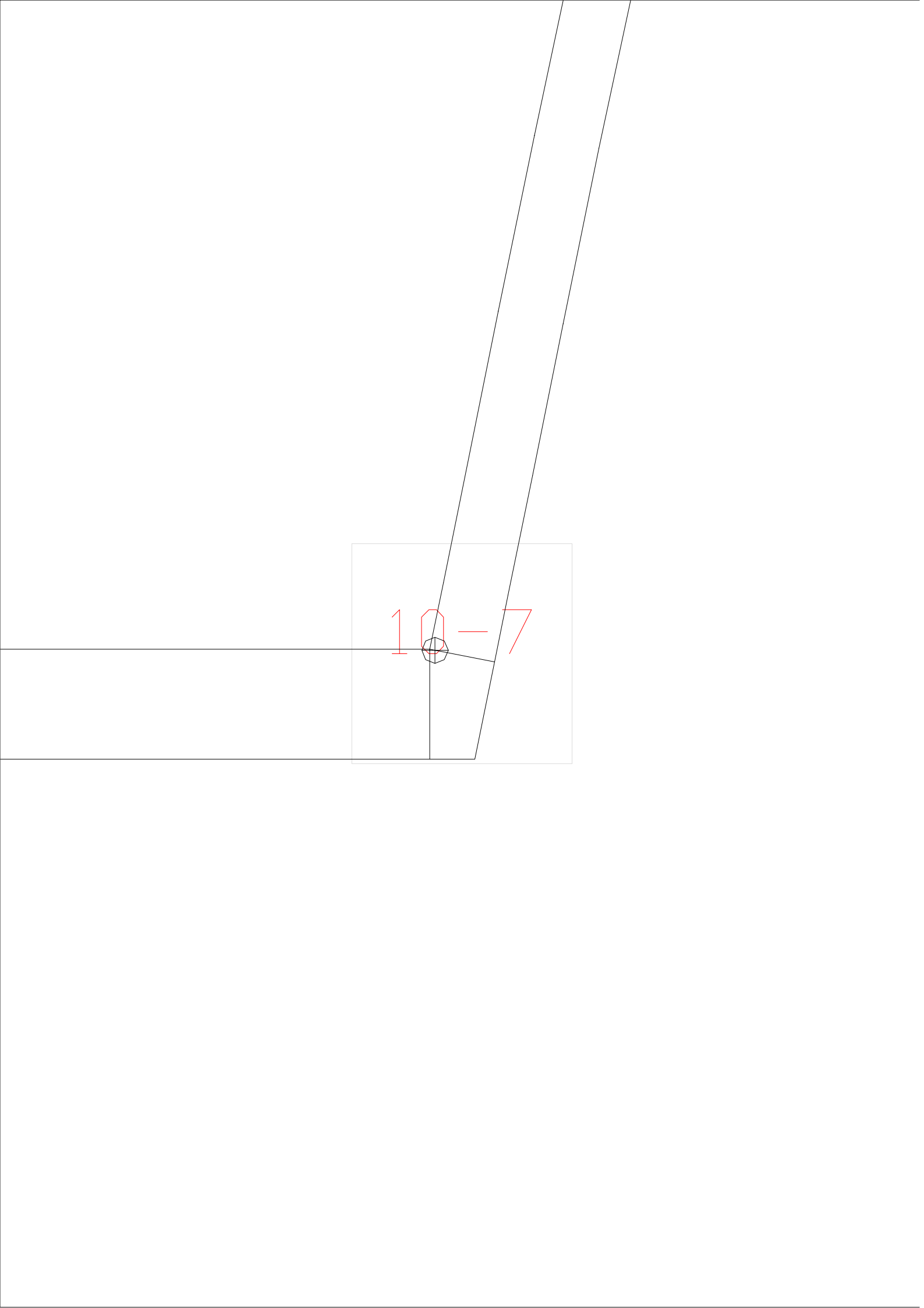

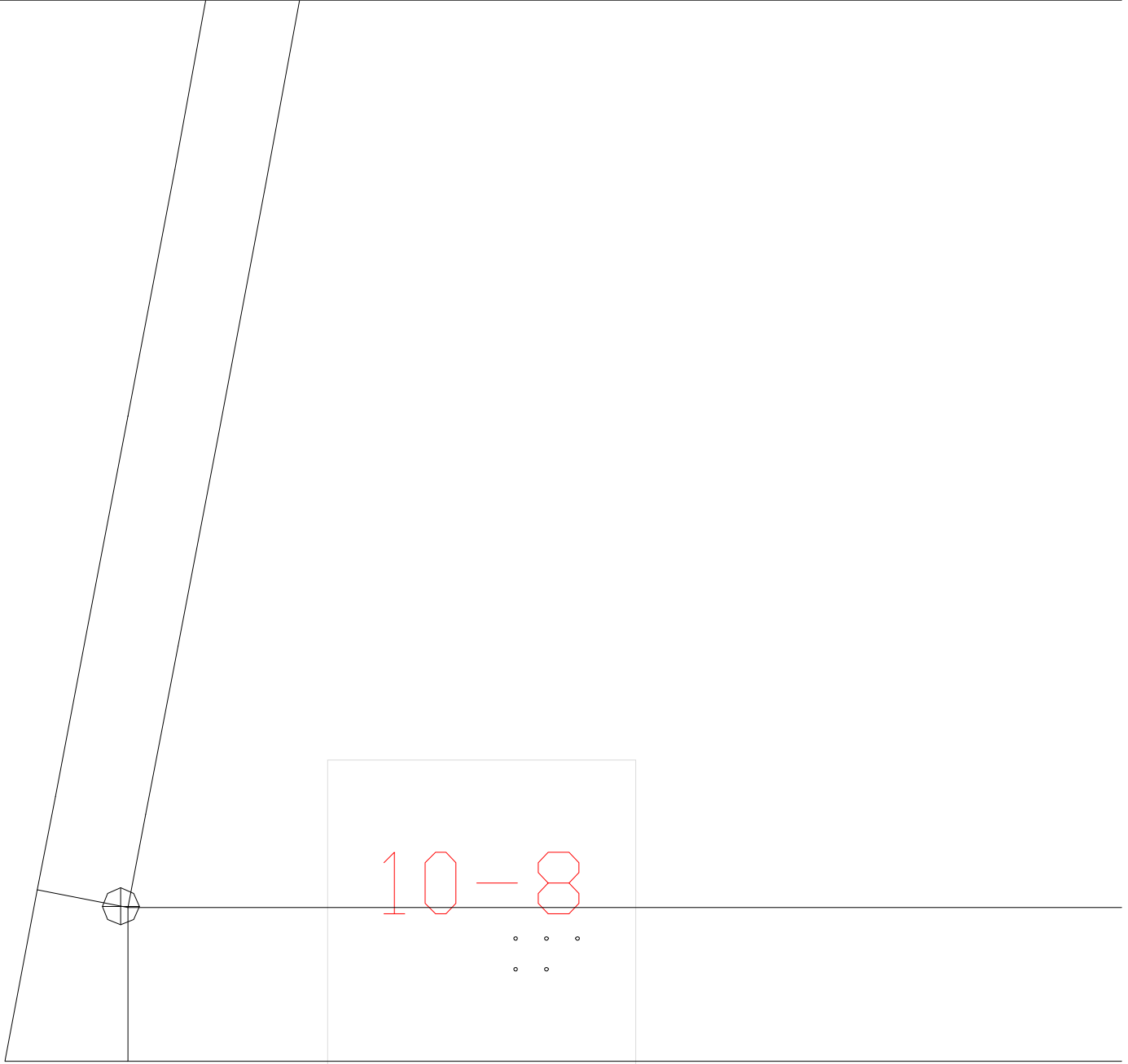

10-8

• • •  
• •

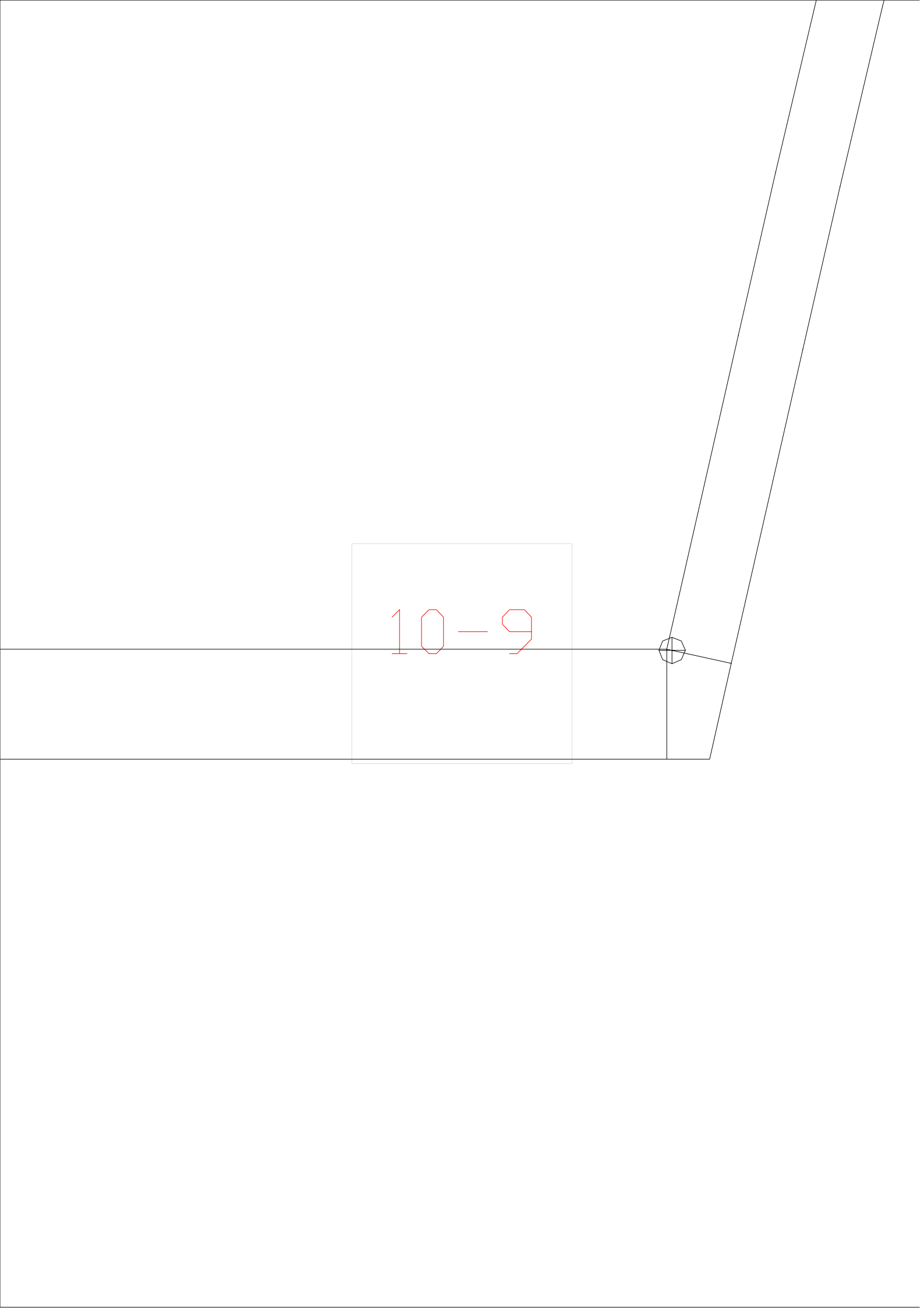

10-9

The image shows a technical drawing of a mechanical component. A horizontal line extends from the left edge to a vertical line. From this vertical line, a horizontal line continues to the right, ending at a circular feature. A vertical line also extends downwards from this circular feature. To the right of the circular feature, two lines diverge upwards and to the right, forming a narrow, elongated shape. A red rectangular box is drawn around the text '10-9', which is centered on the horizontal line between the vertical lines.



1-10

1 - 11

1-12

1-13



1-15

1-16





1-18

1-19

1 - 1

1-20

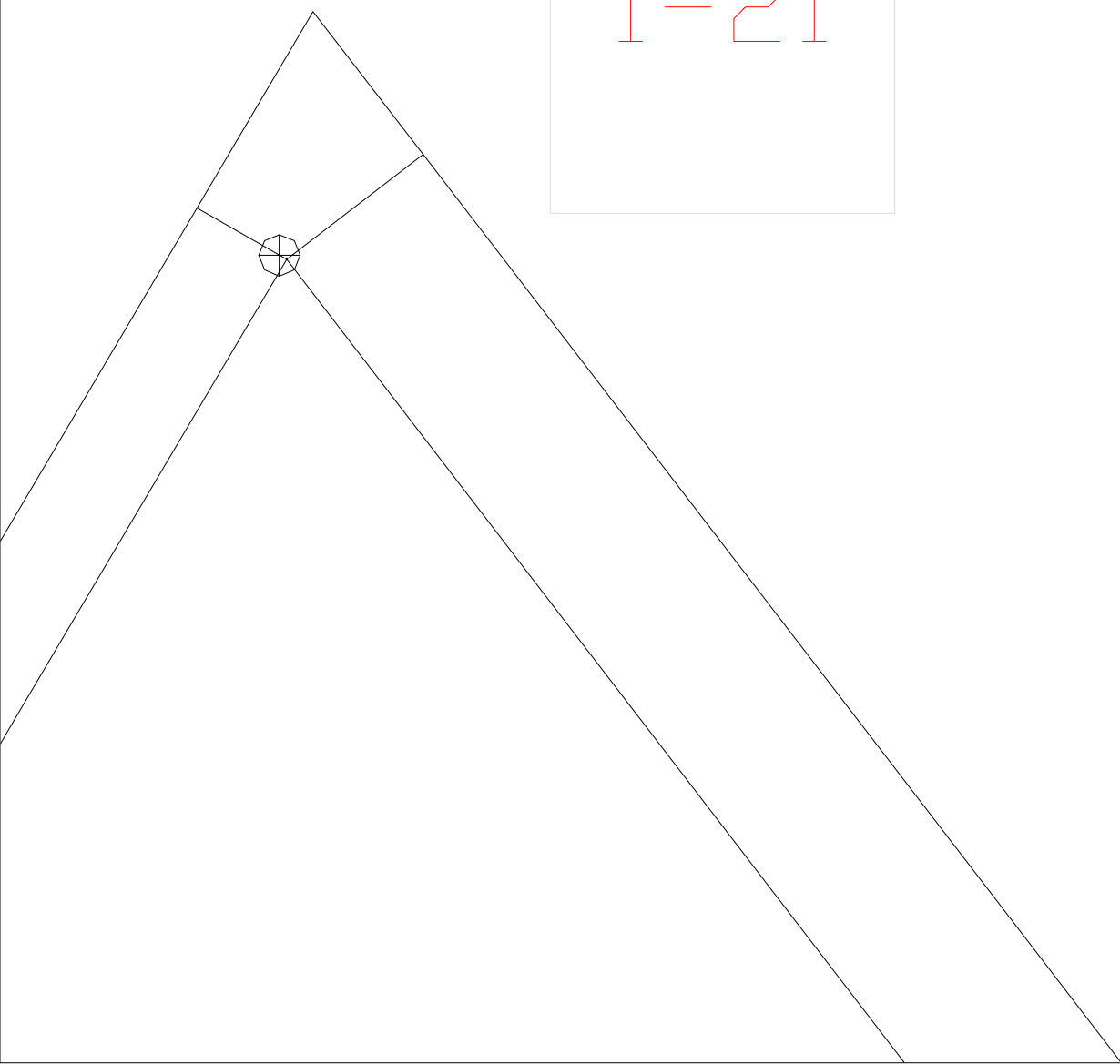

1-21

1-22

1-23

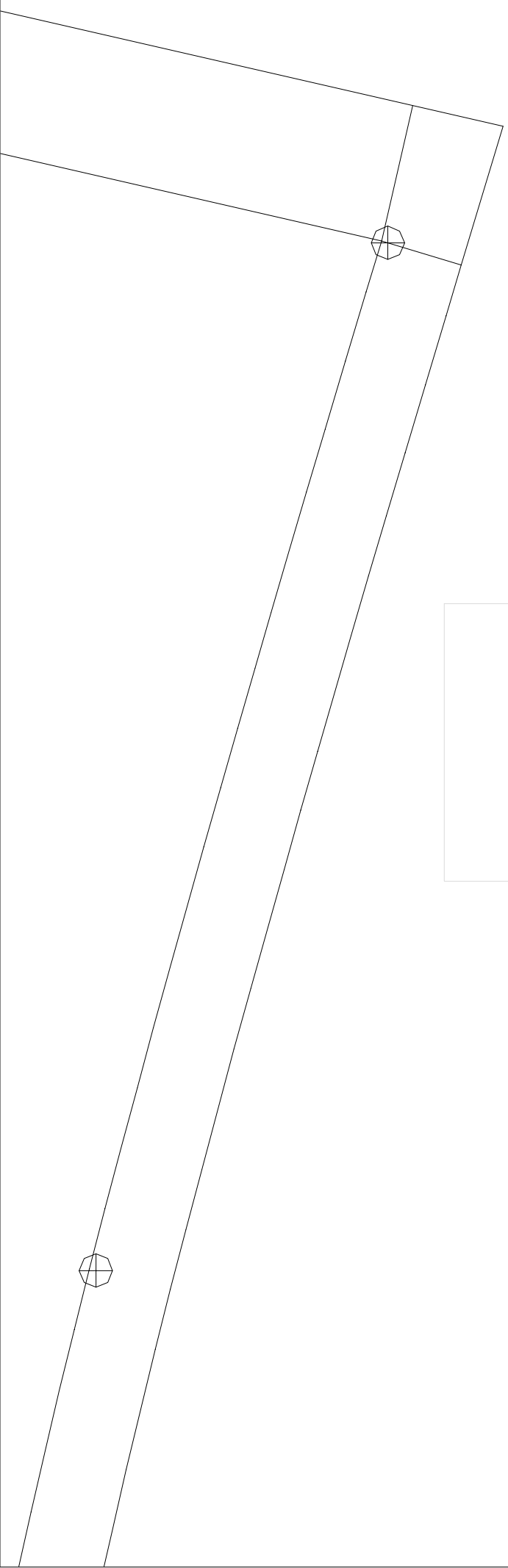

1-2



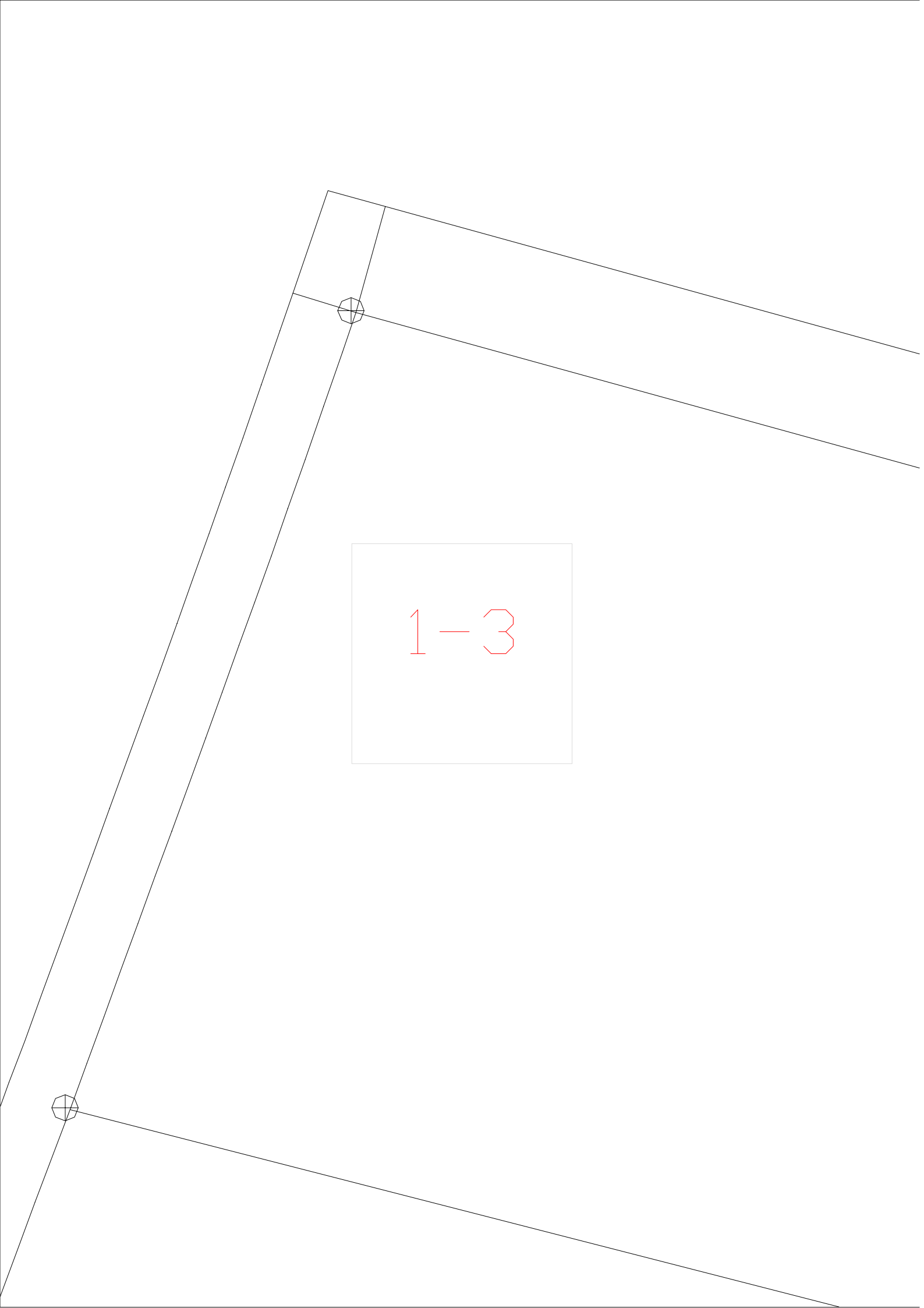

1-3



1-4

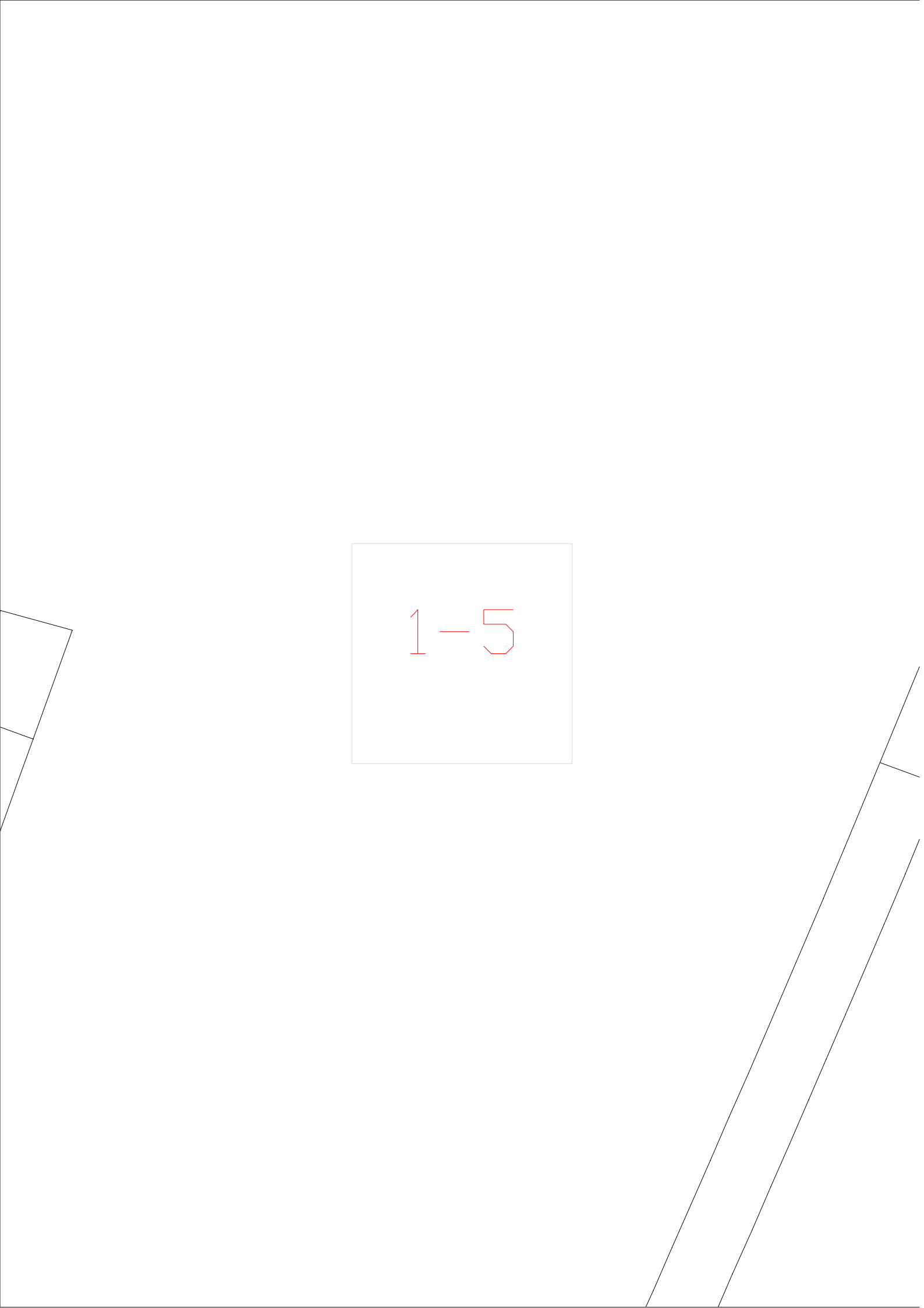

1-5

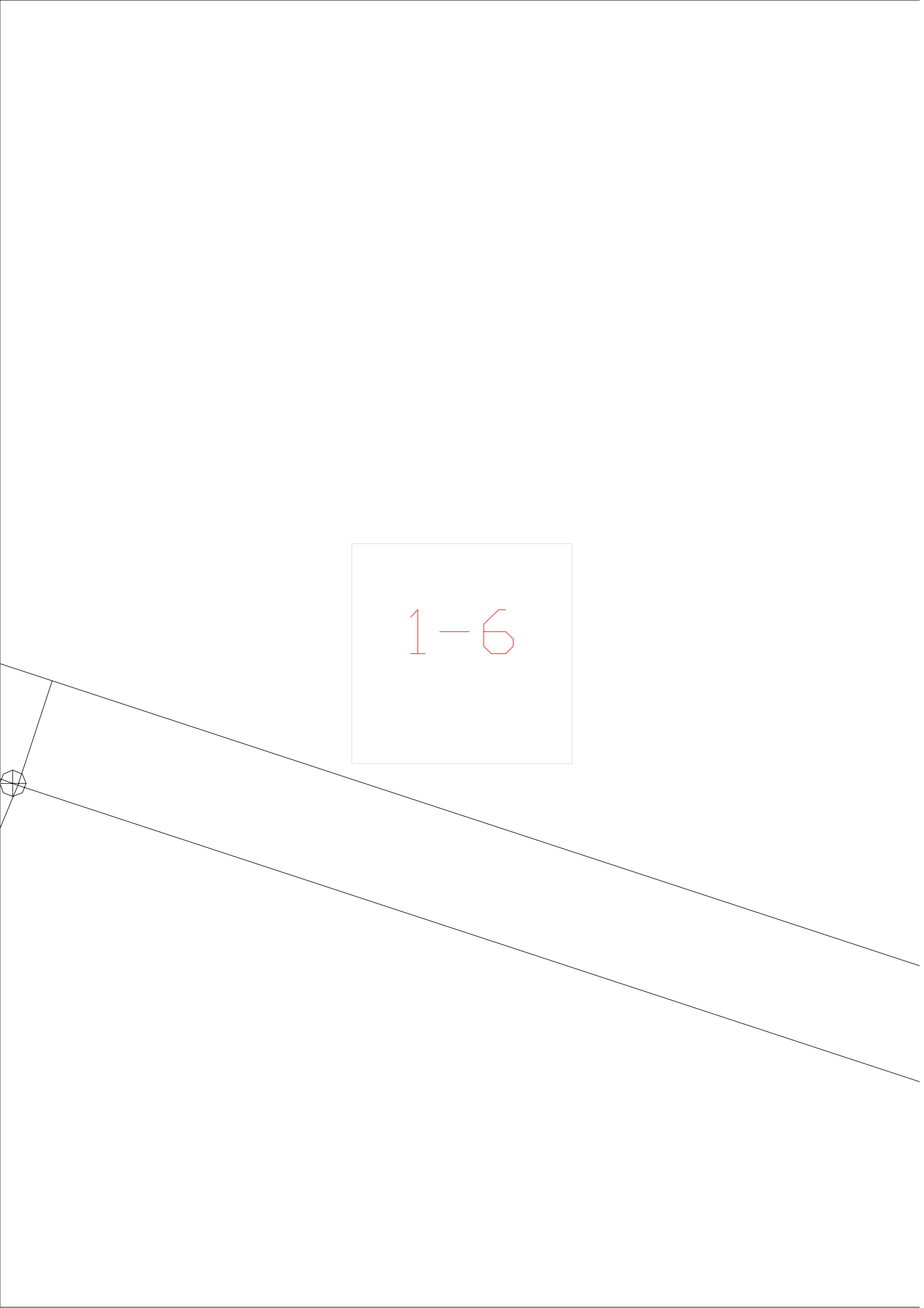

1-6

The image shows a technical drawing of a corner. On the left, a vertical line and a horizontal line meet at a corner. A small circle with a cross inside is drawn at this corner. Two lines extend from this corner towards the right, one above the other, representing a sloped surface. A square box is drawn in the center of the page, containing the text '1-6' in red.

1-7

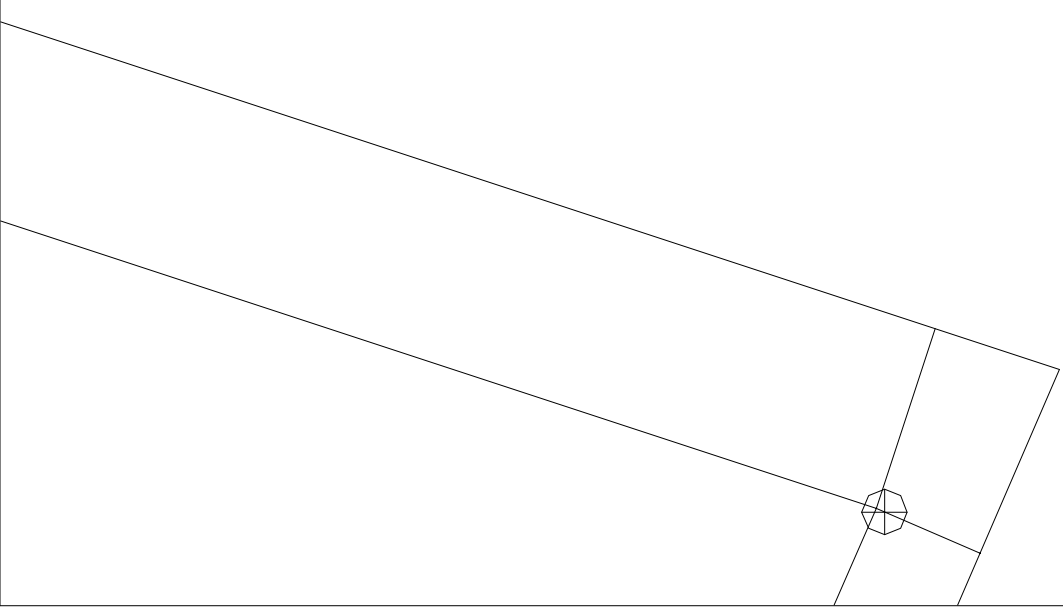

1-8

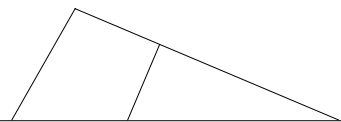

1-9

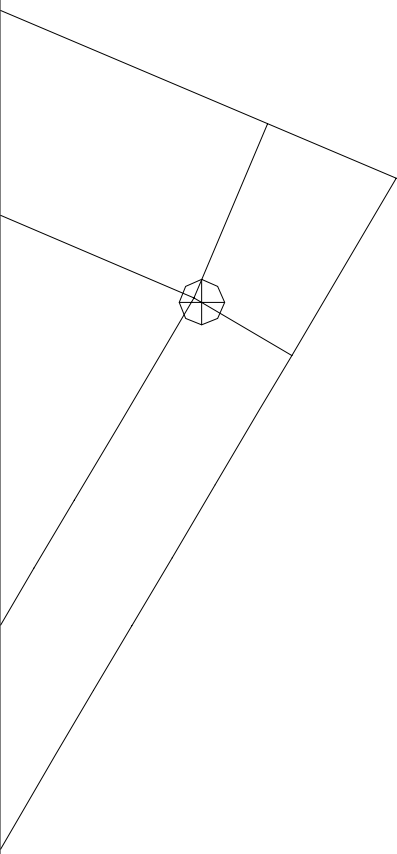

2-10

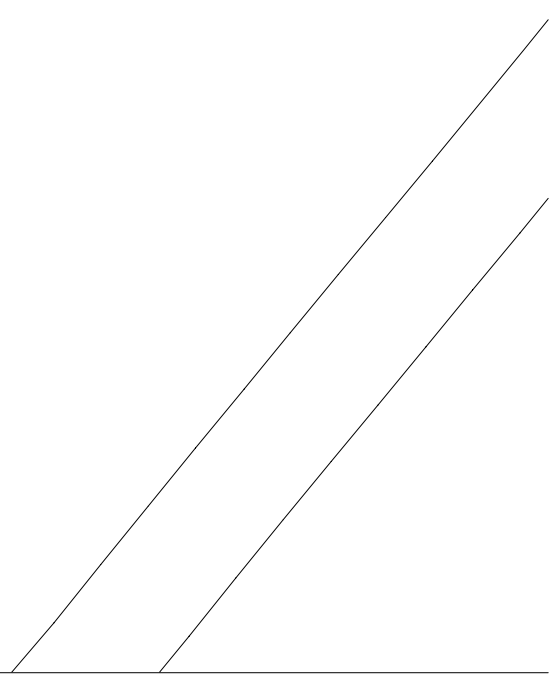



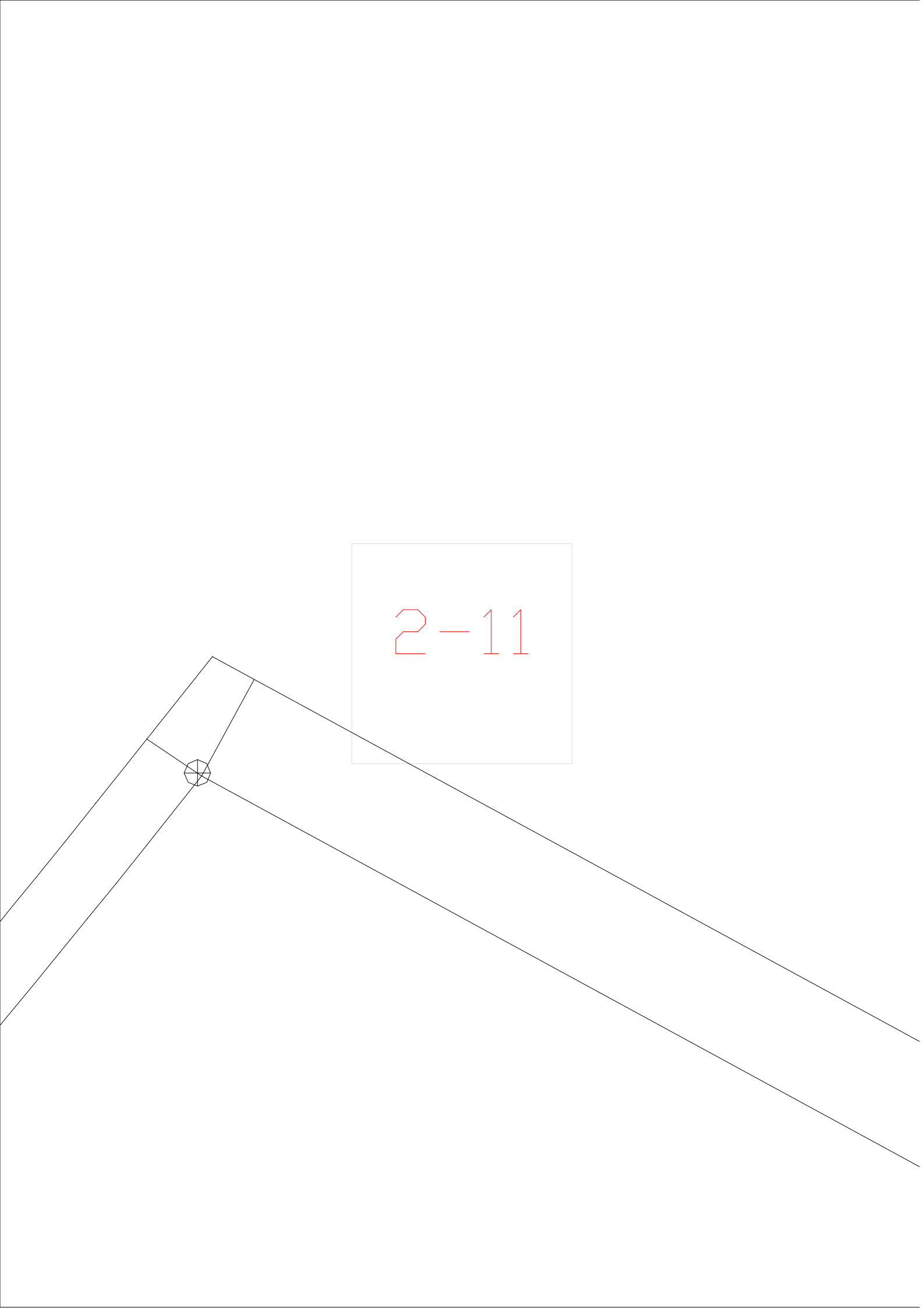

2-11

2-12

2-13

2-14

2-15

2-16

2-17

2-18



2-19

2-1



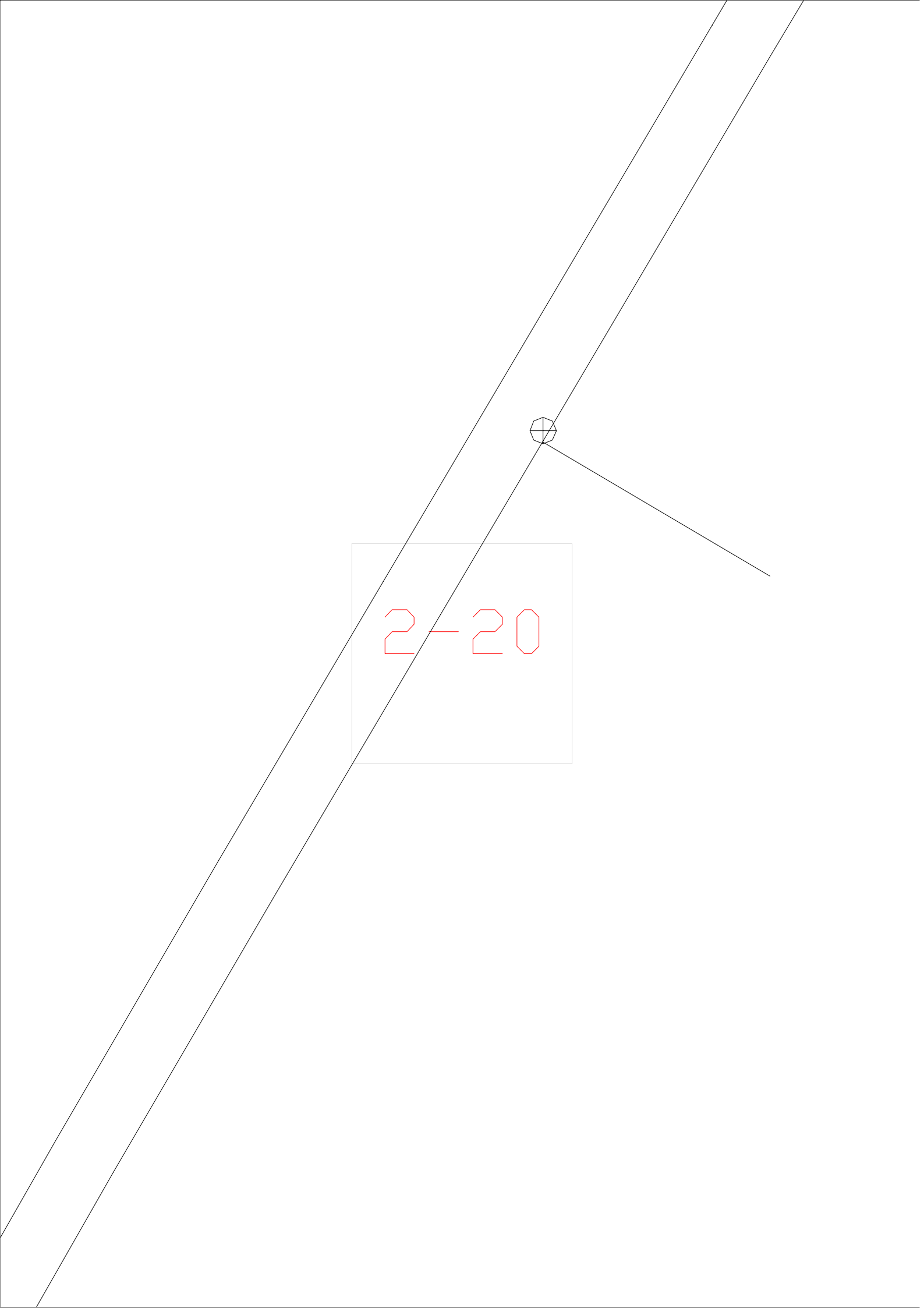

2-20

2-21

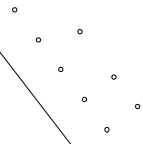

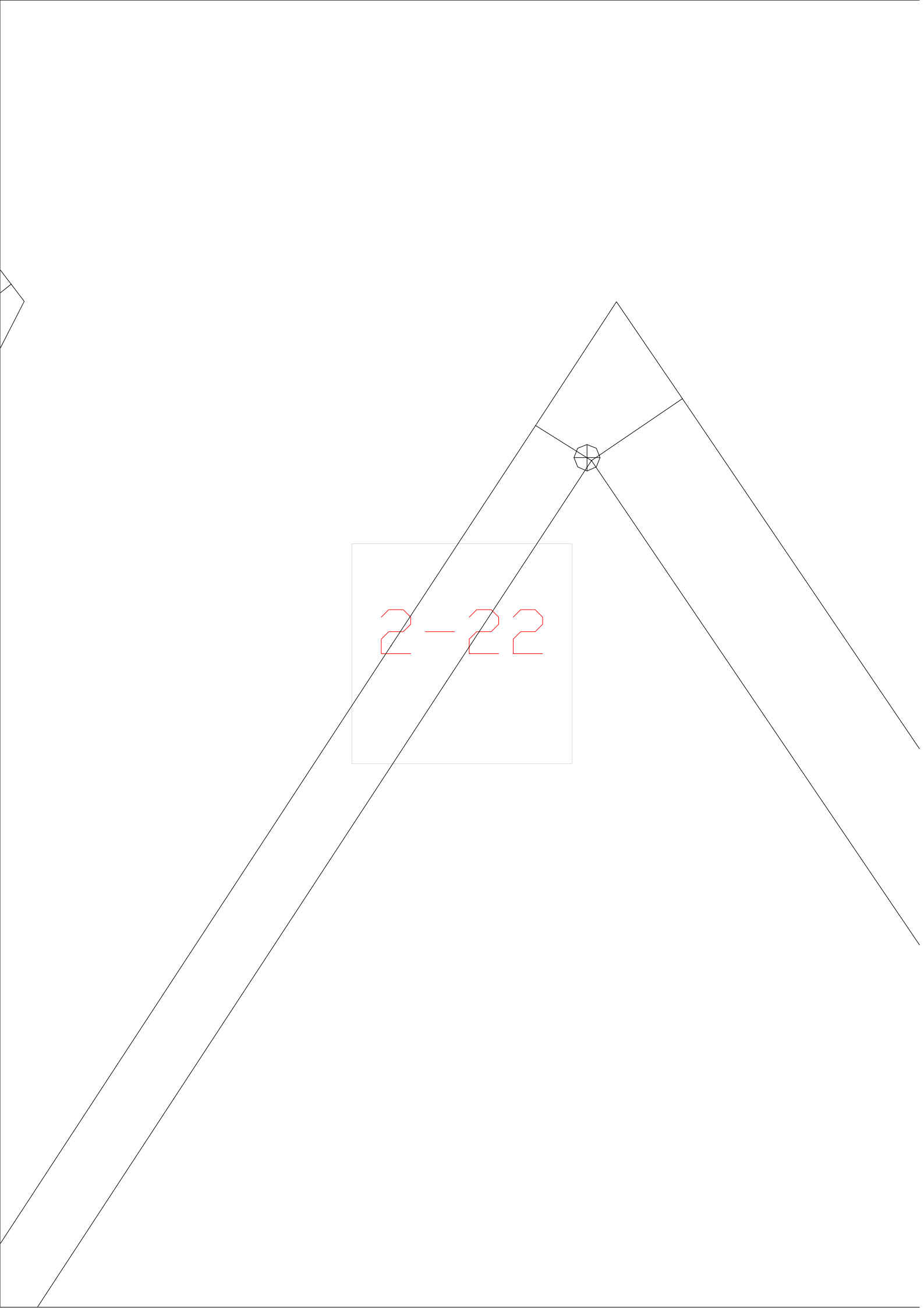

2-22

2-23

o  
o  
o  
o  
o  
o  
o  
o  
o  
o

2-2



2-3



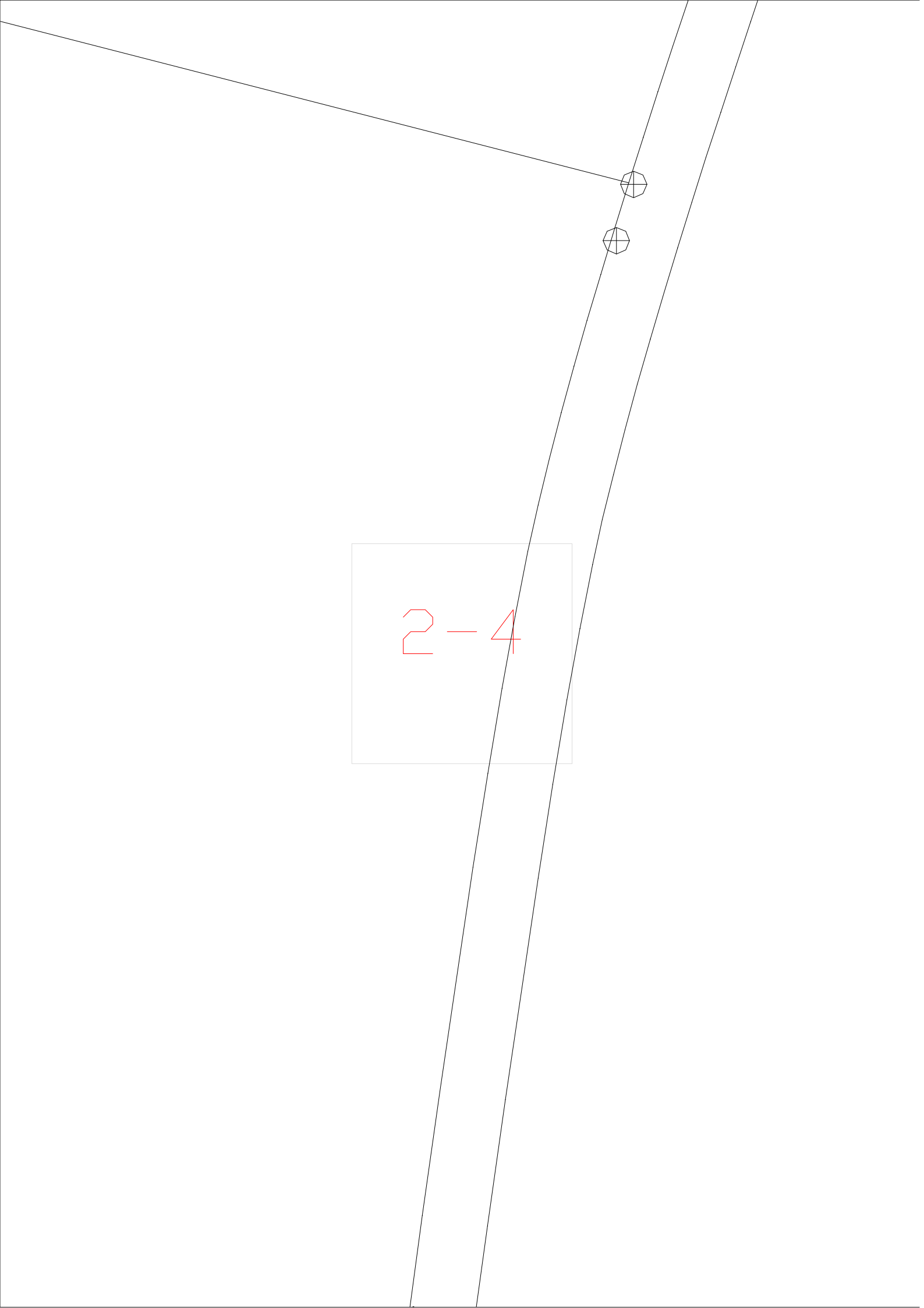

2-4

The image shows a technical drawing of a tapered shaft. The shaft is represented by two parallel lines that converge towards the right, indicating a taper. At the right end of the shaft, there is a chamfered edge. Two circular features, likely representing holes or grooves, are shown on the tapered surface. A square hole is located in the middle of the shaft, and the number '25' is written in red inside this square hole. The drawing is a simple line drawing with no shading or color, except for the red text.

25

2-6

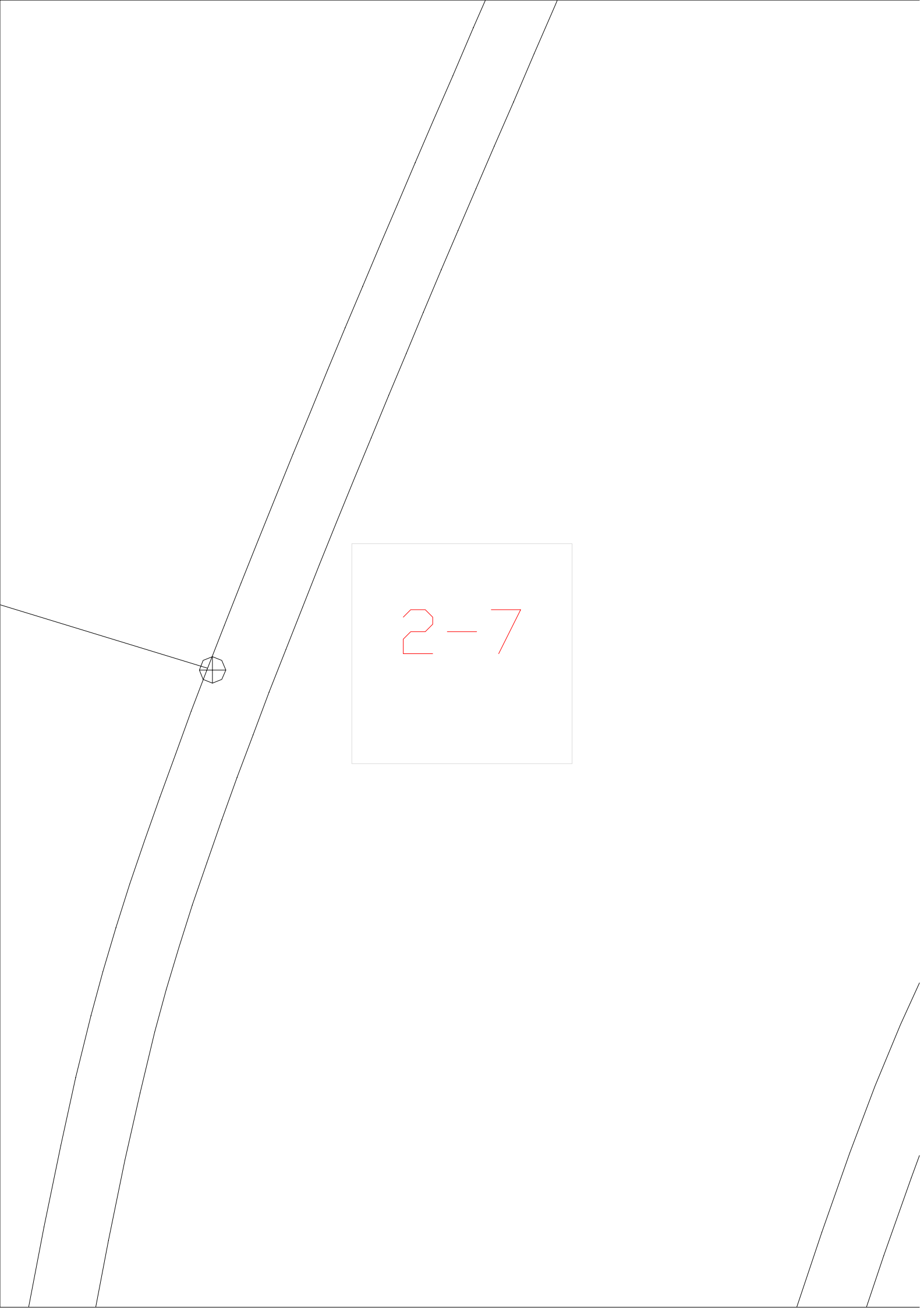

2-7

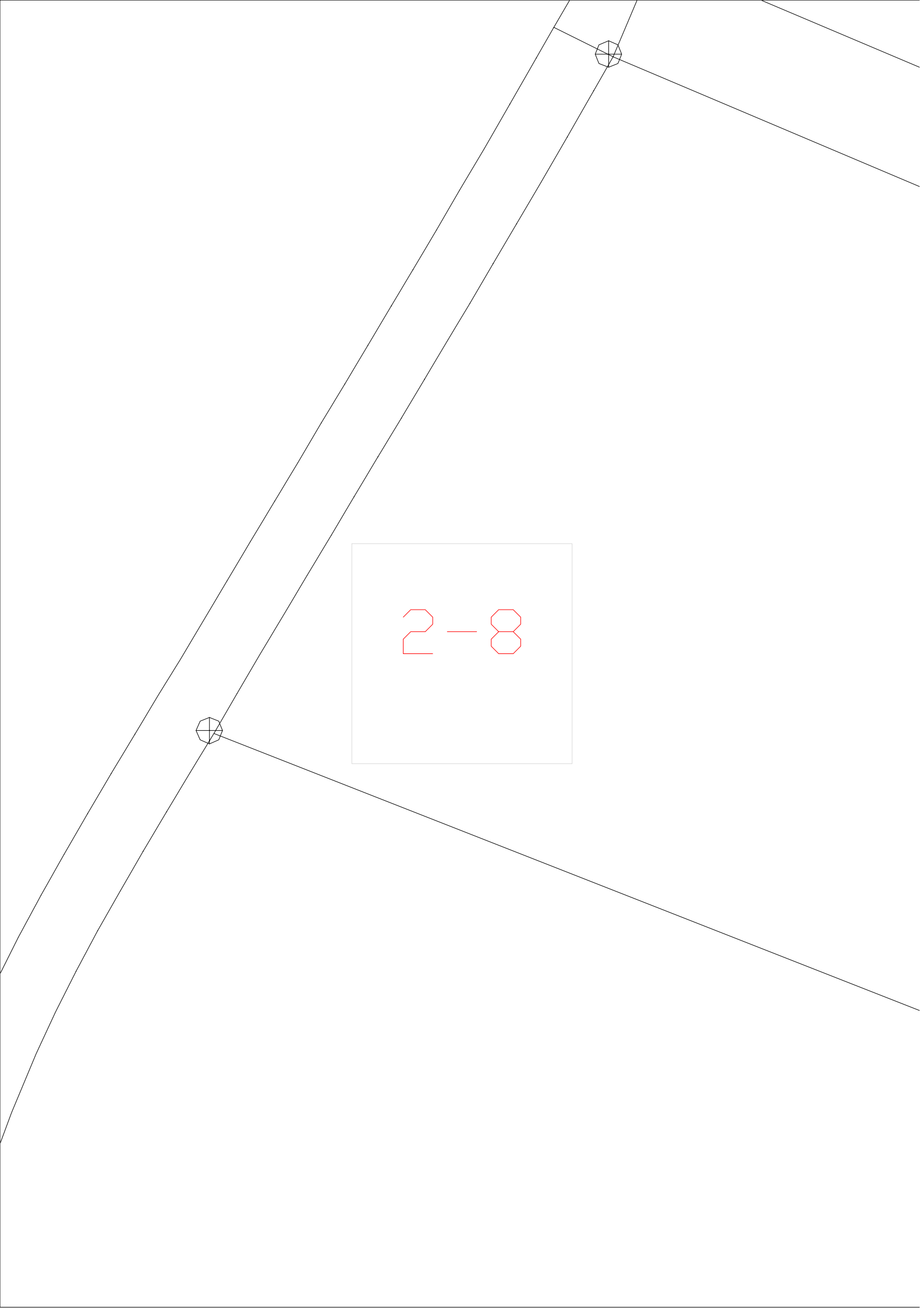

2-8

2-9



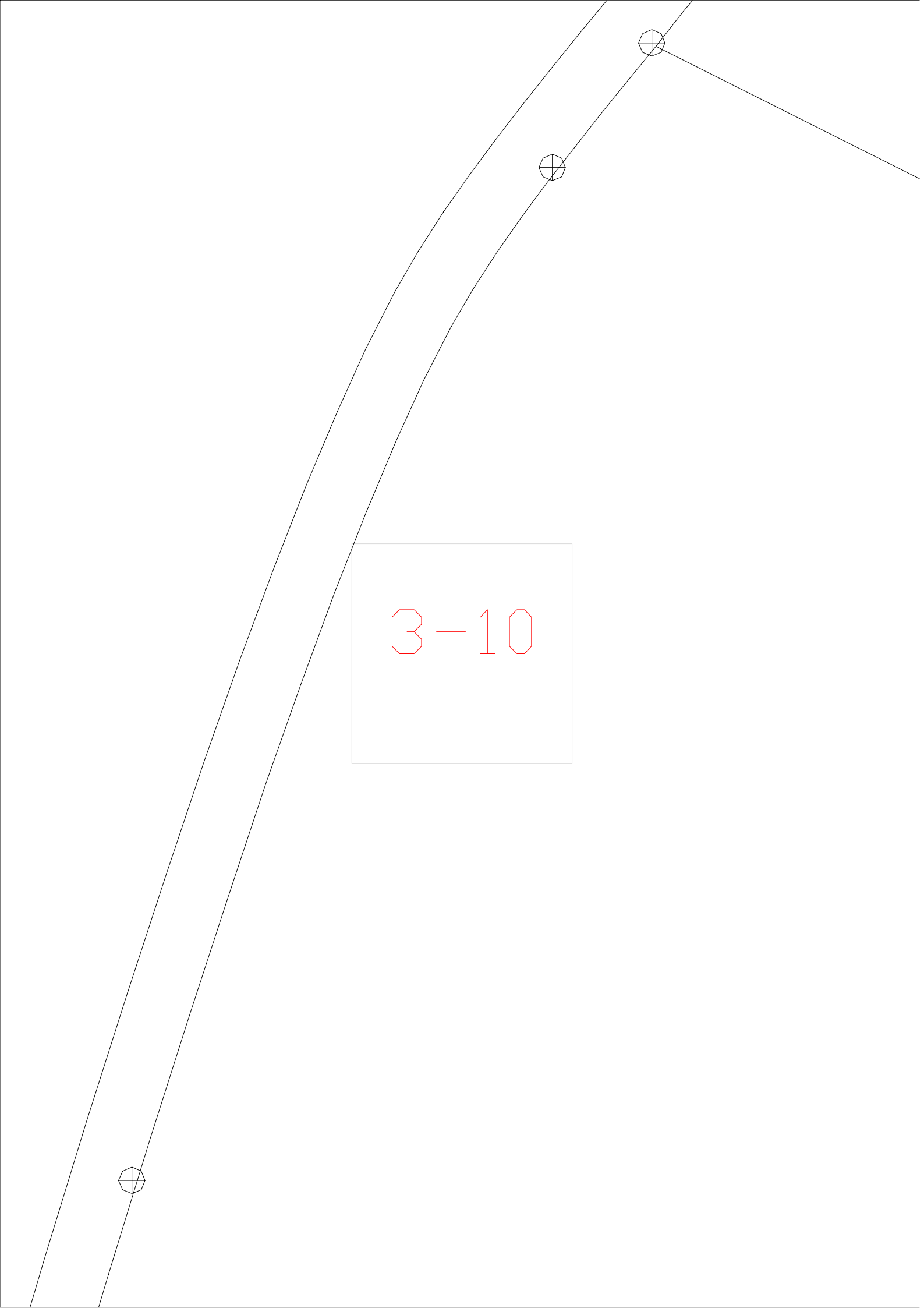

3-10

3-11





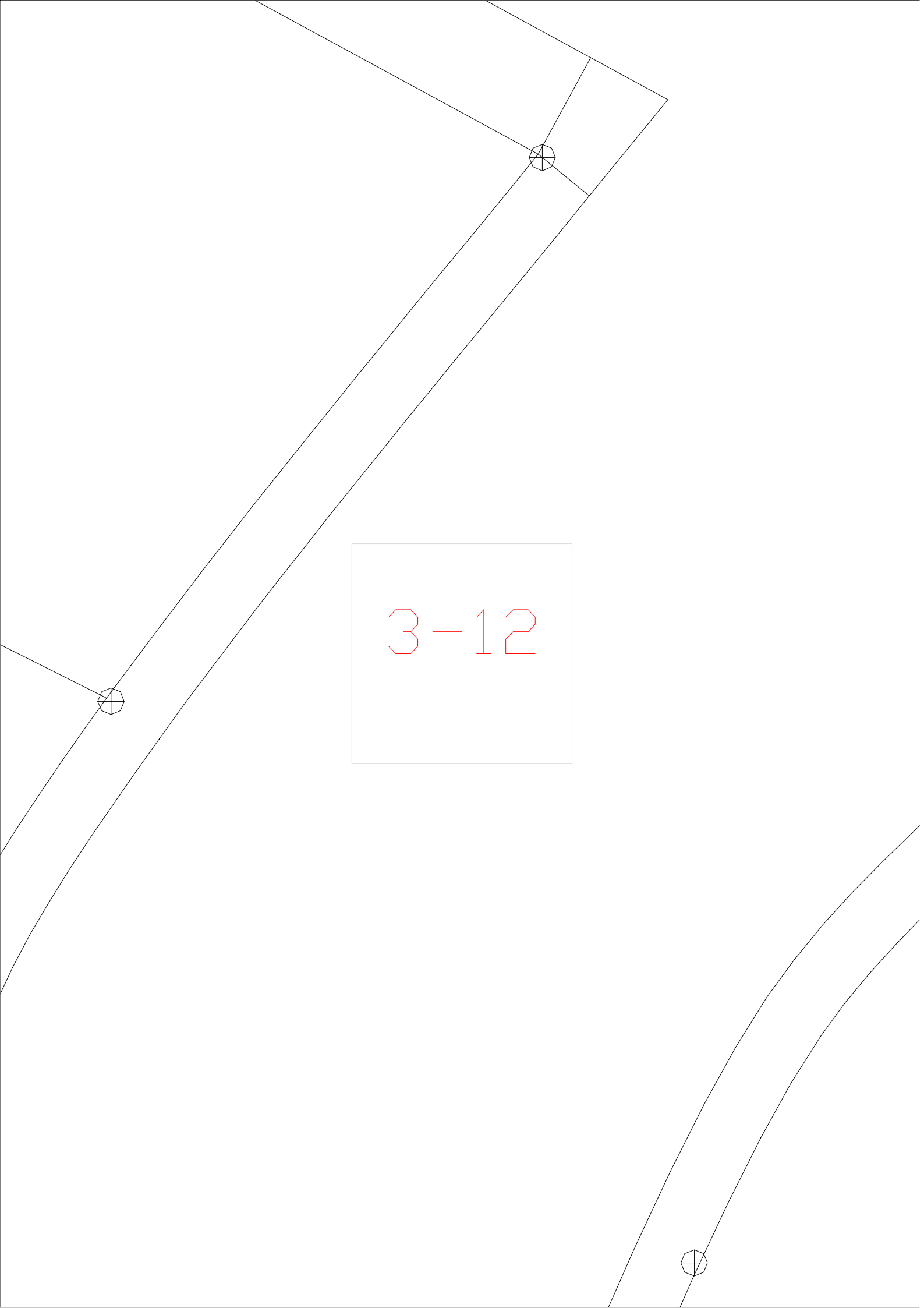

3-12

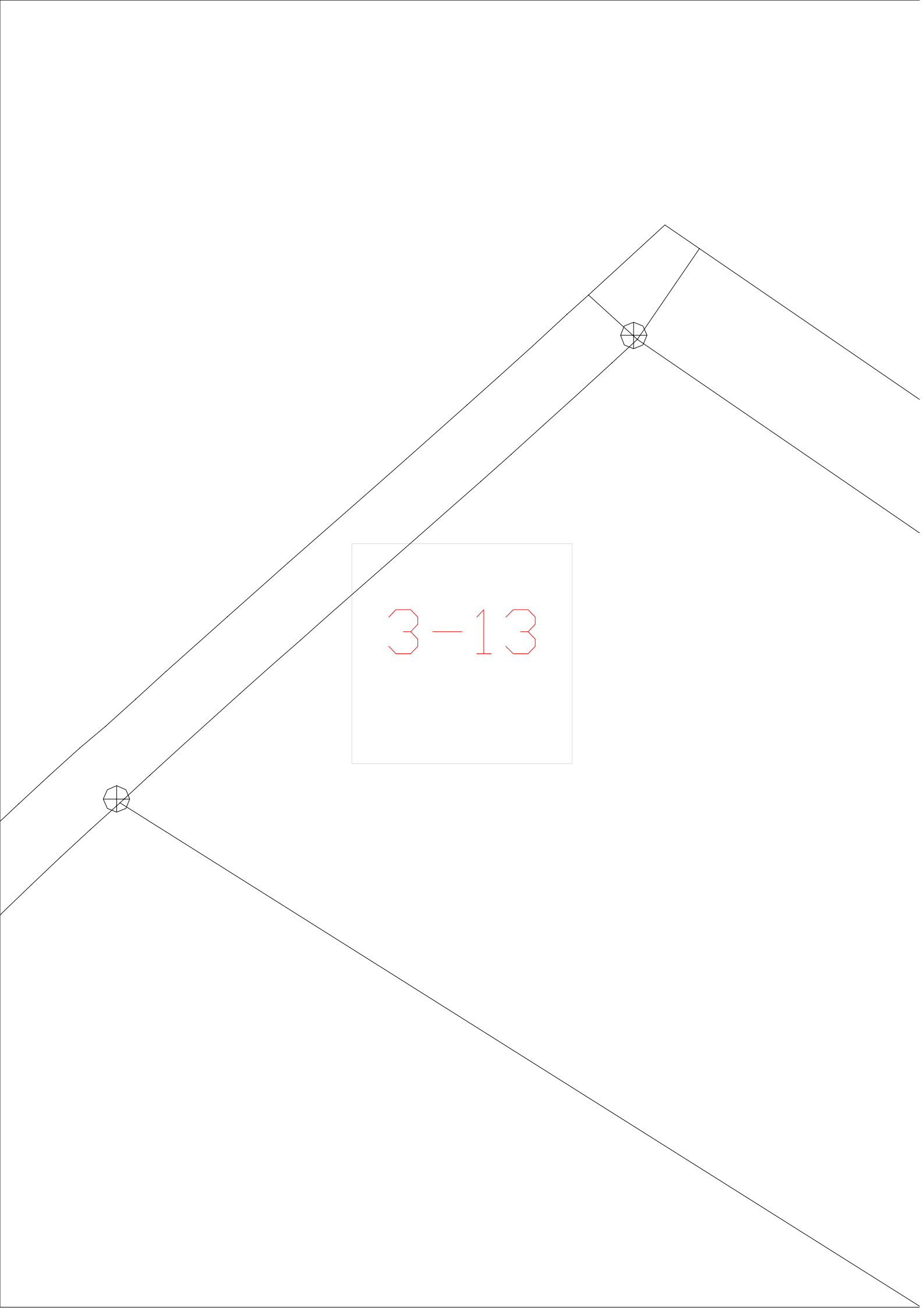

3-13

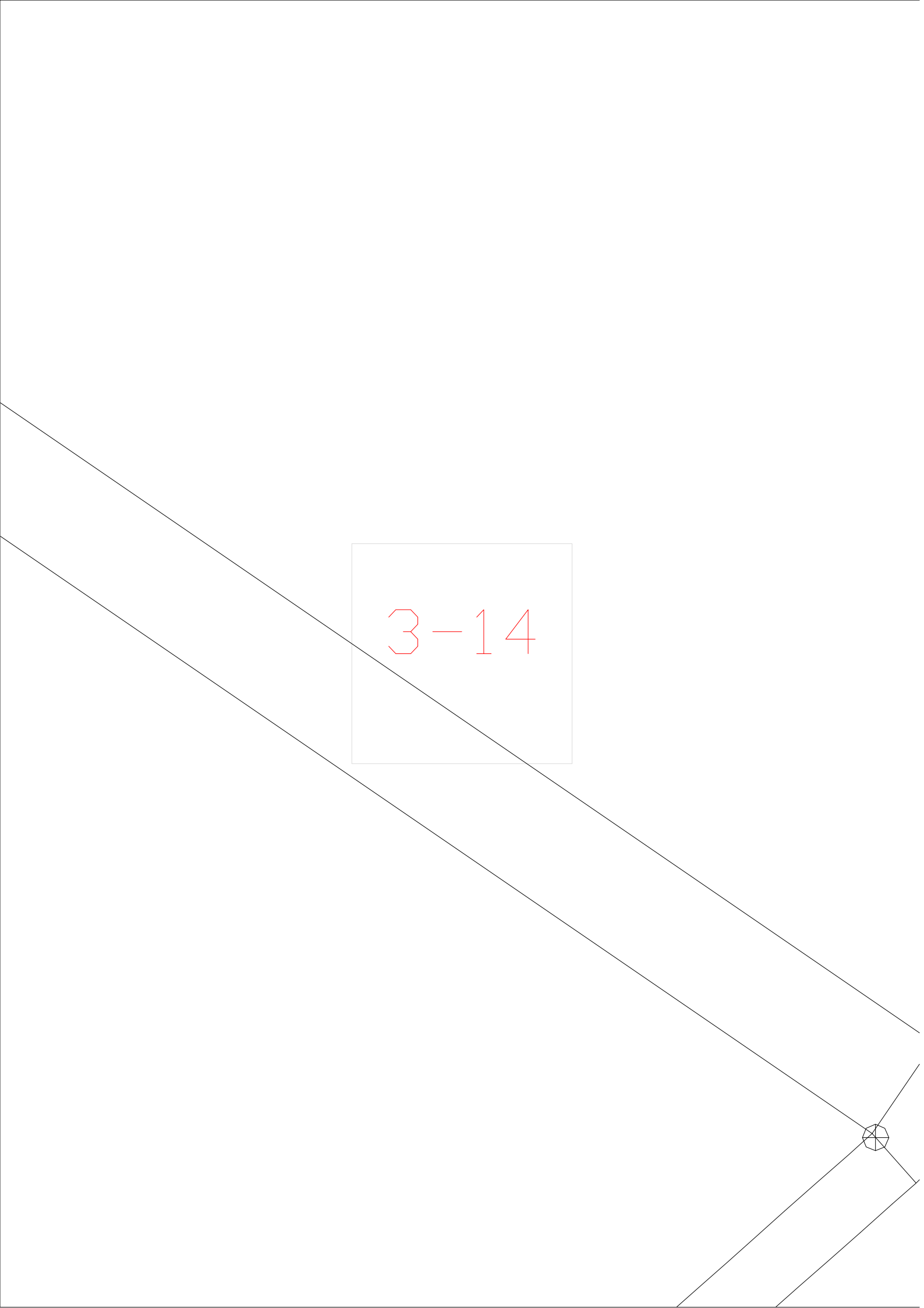

3-14

The image shows a technical drawing of a rectangular plate. The plate is oriented vertically. A diagonal line runs from the top-left corner towards the bottom-right corner. A rectangular hole is cut out from the center of the plate, with the number '3-14' inscribed inside it in red. In the bottom-right corner, there is a circular hole-in-a-hole feature, consisting of a larger outer circle and a smaller inner circle, both with crosshairs indicating their centers. The drawing is composed of thin black lines on a white background.

3-15

3-16

3-17

3-18

3-19





3-1



3-20



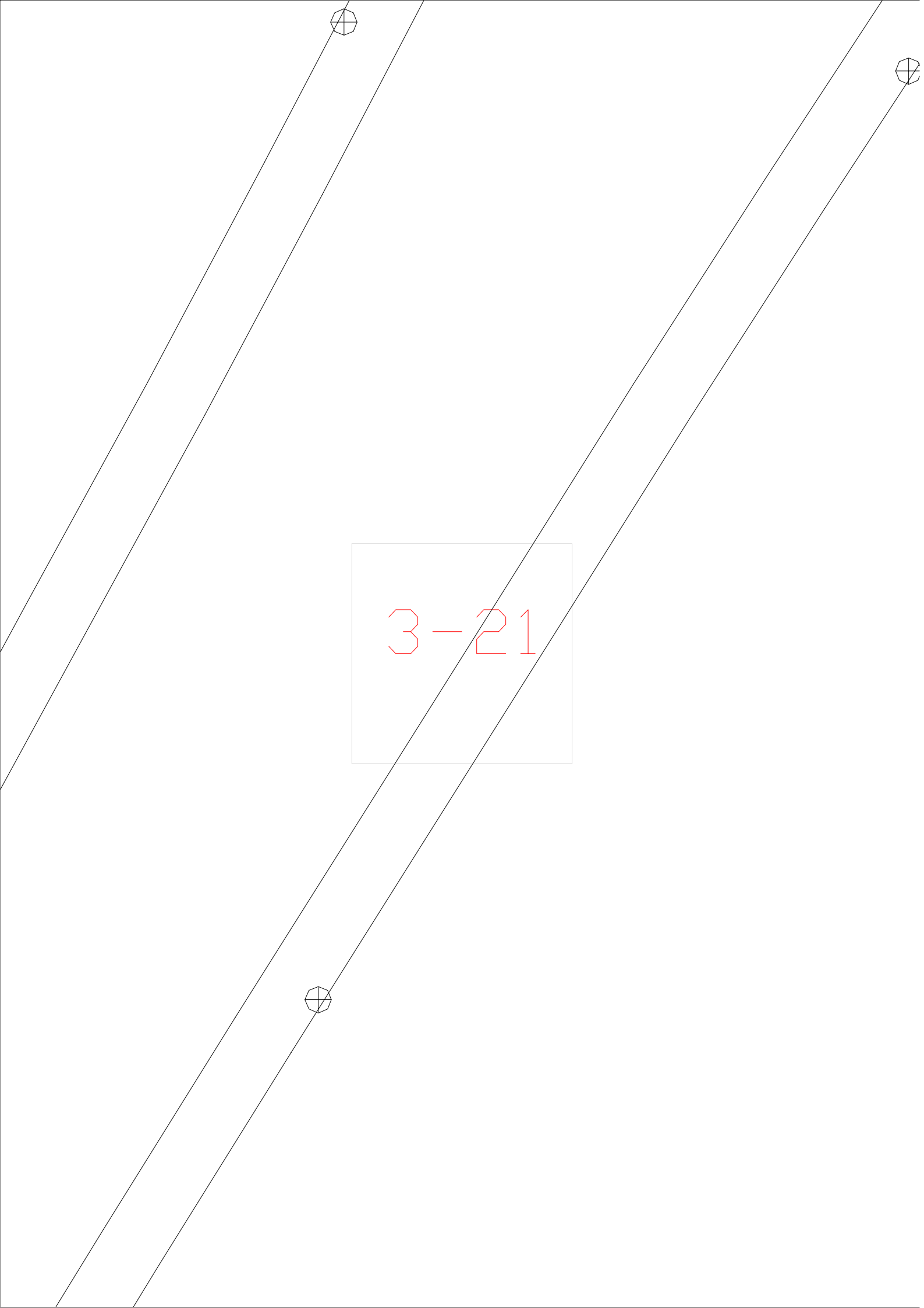

3-21

3-22



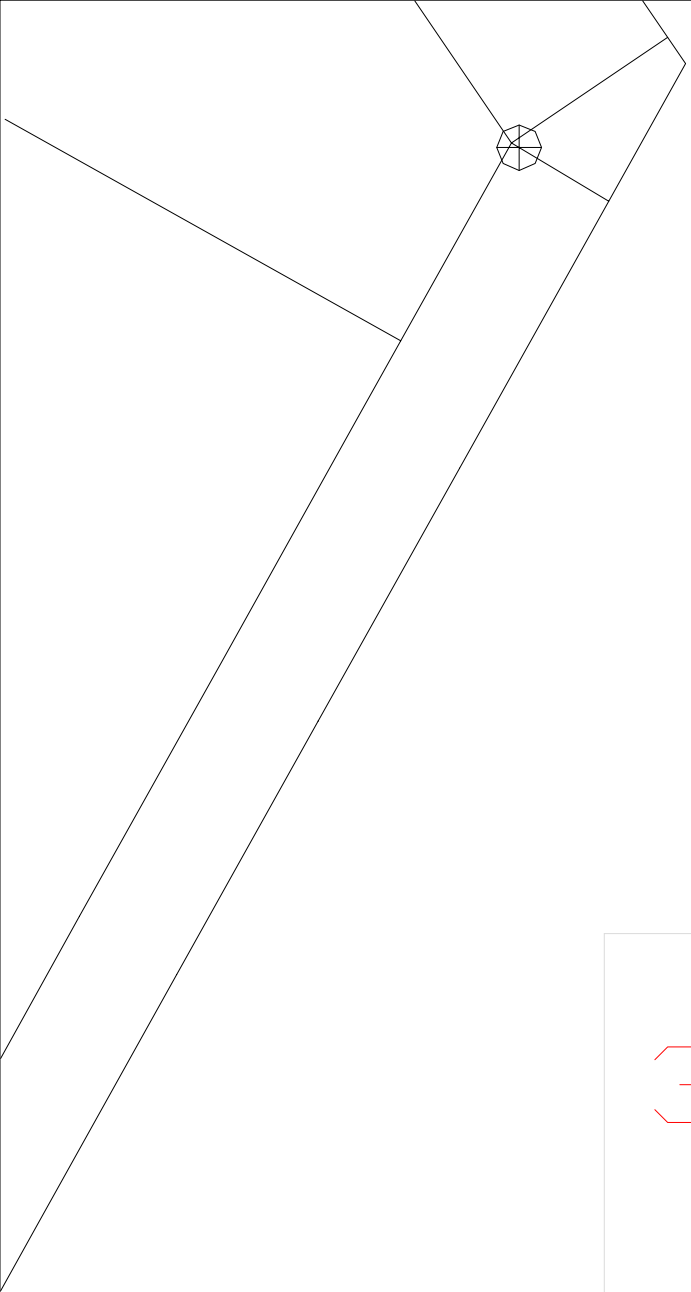

3-23

3-2



3-3

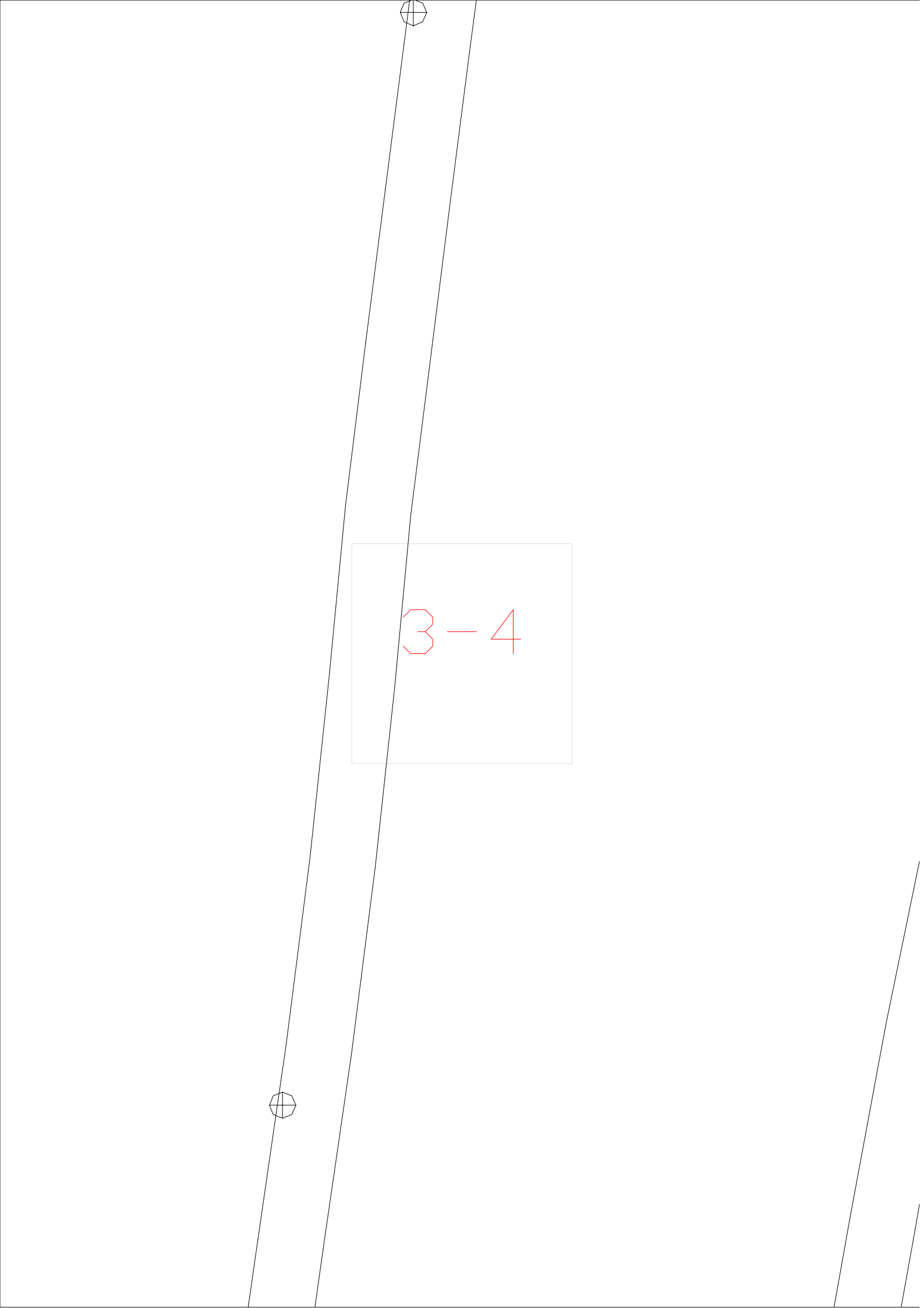

3-4



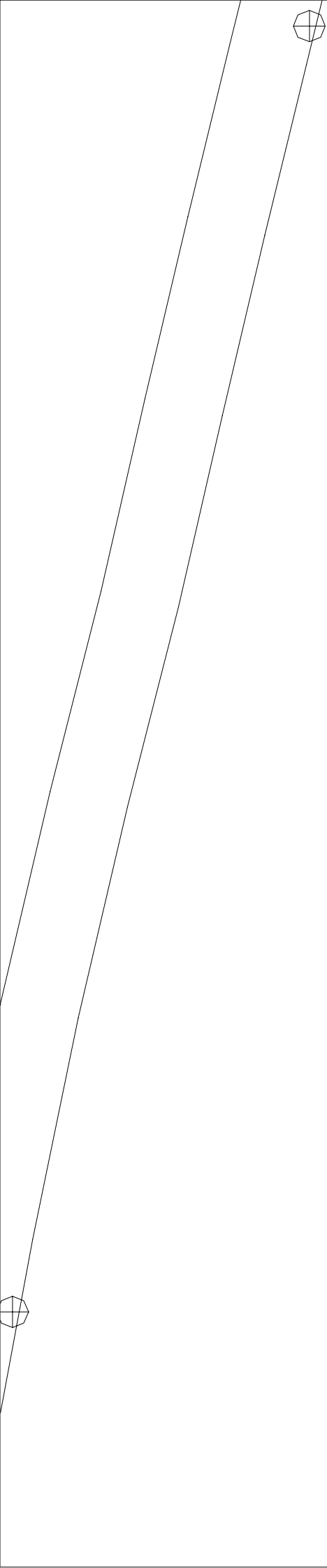

3-5

3-6



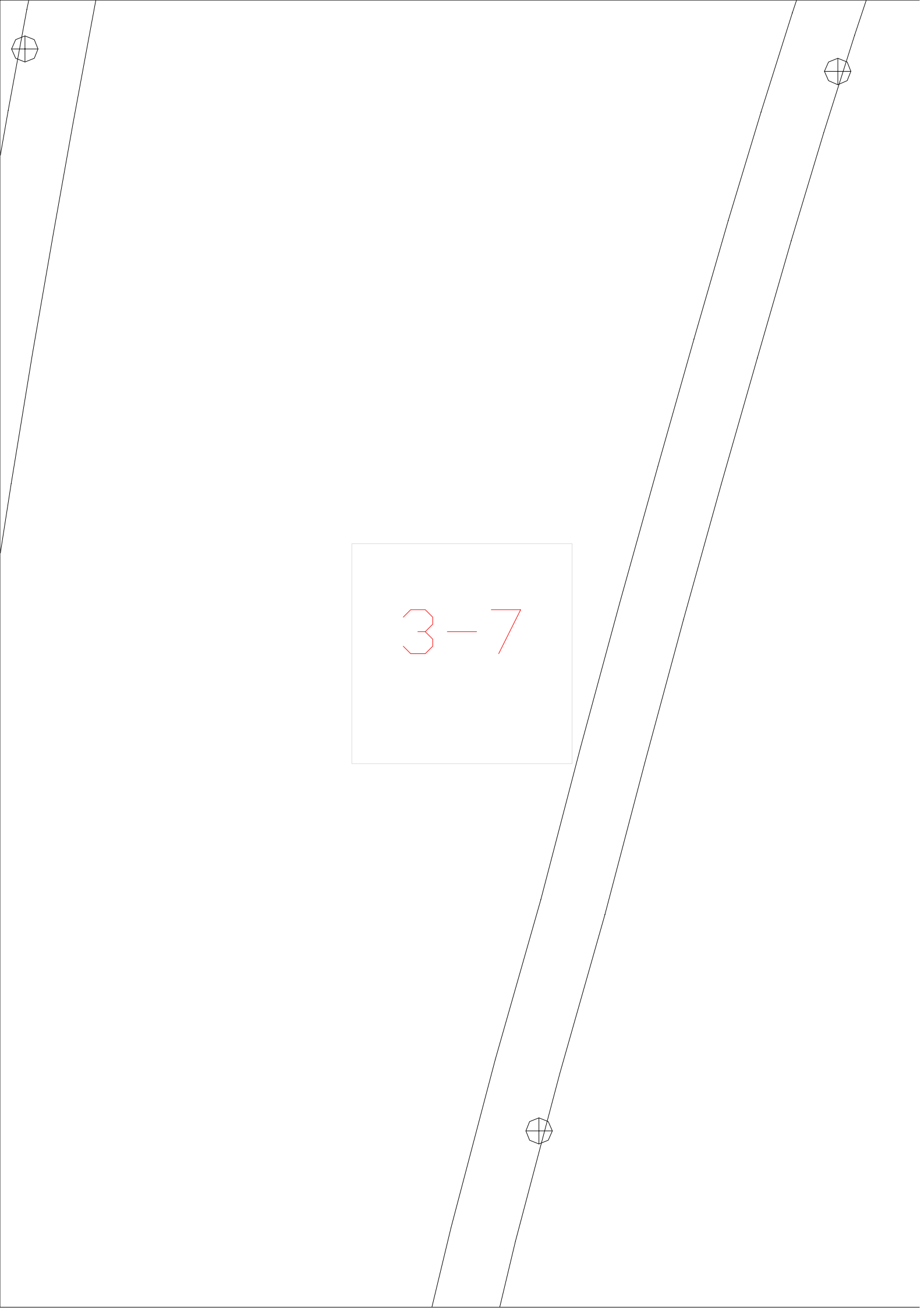

3-7

3-8

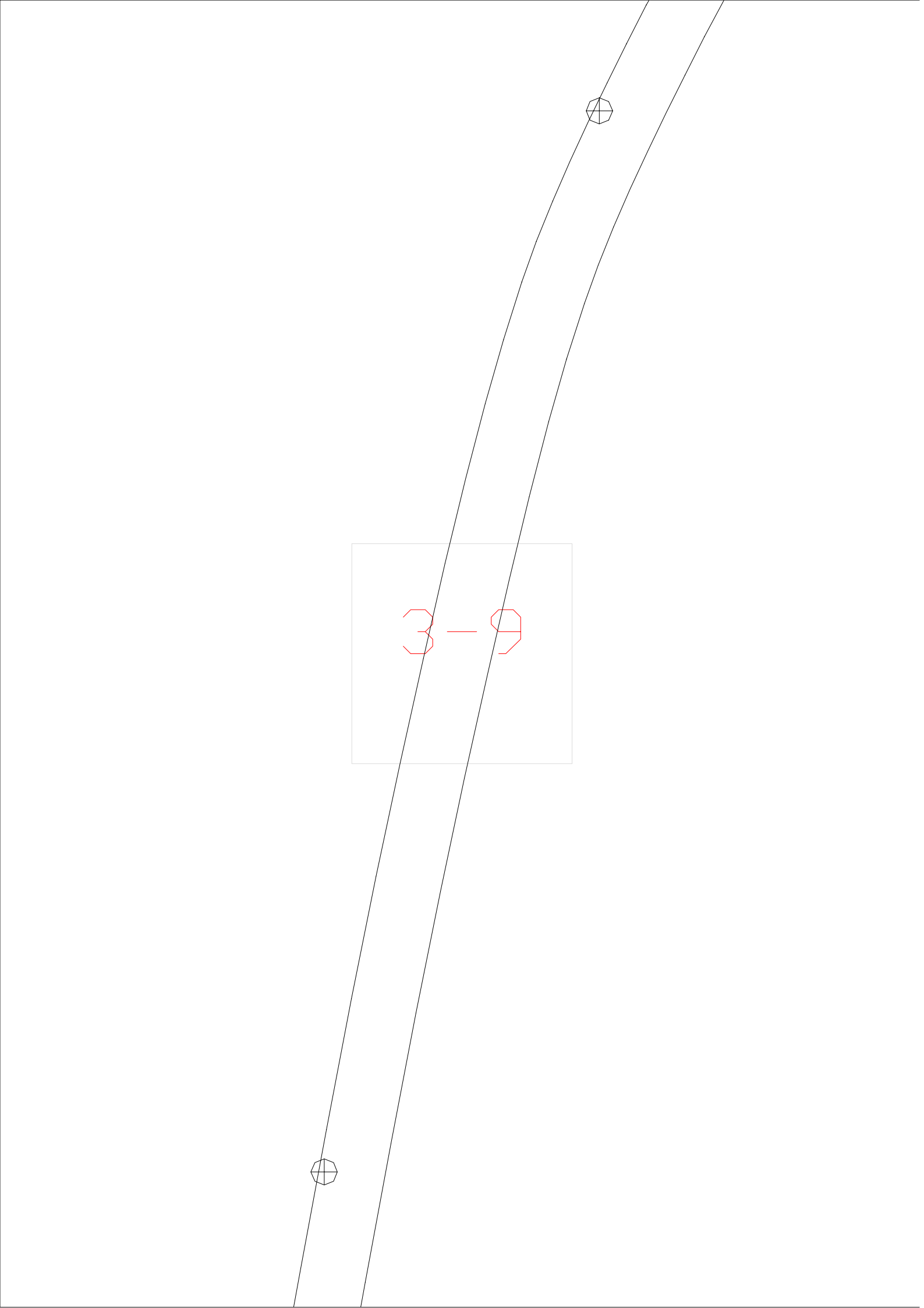

3-9

The diagram shows a curved path defined by two parallel lines that curve inward towards each other. Two circular markers, each containing a crosshair, are placed on the path: one at the lower-left end and one at the upper-right end. A light gray rectangular box is centered on the path, containing the red text '3-9'.

4-10

4-11



4-12





4-13

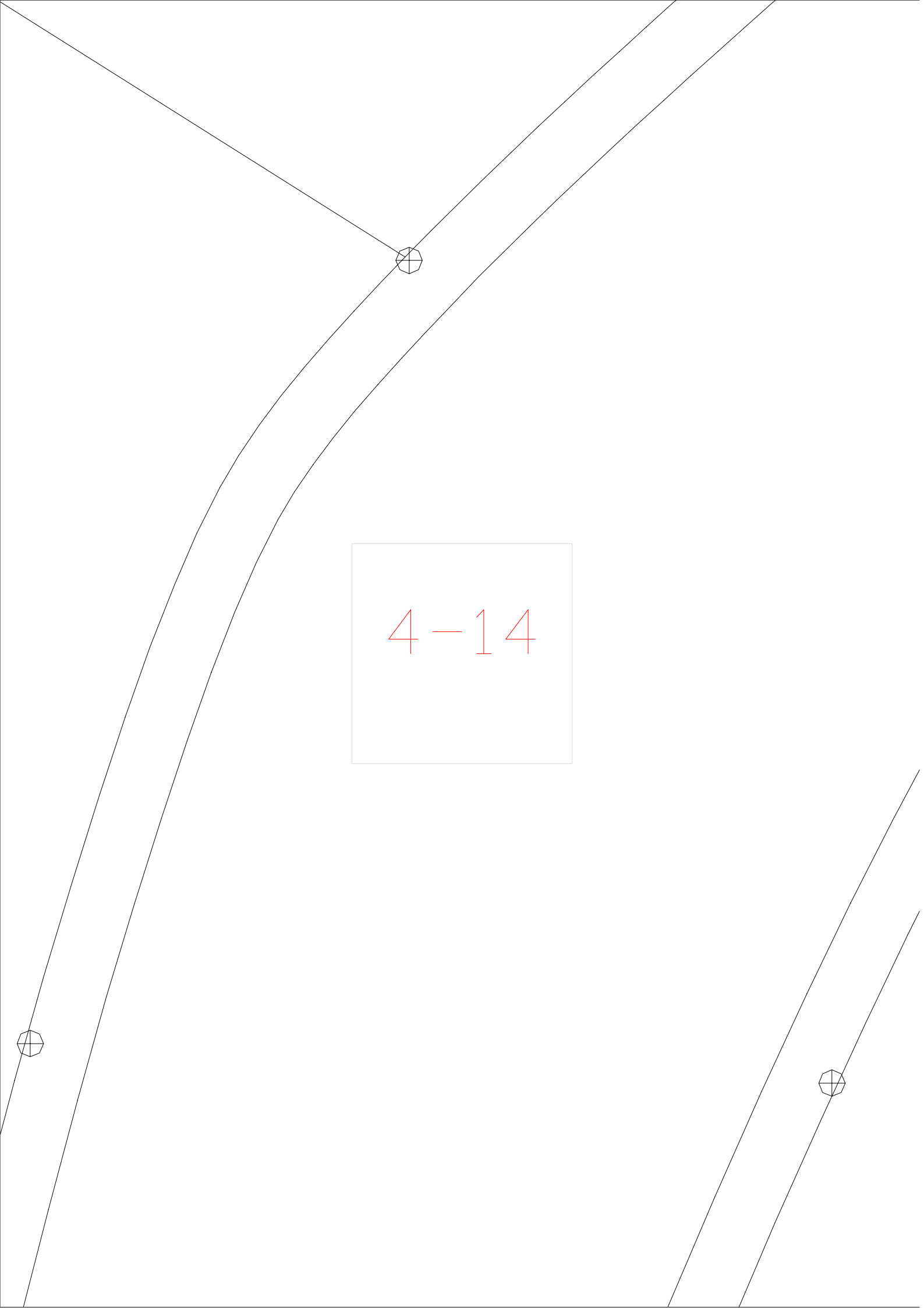

4-14

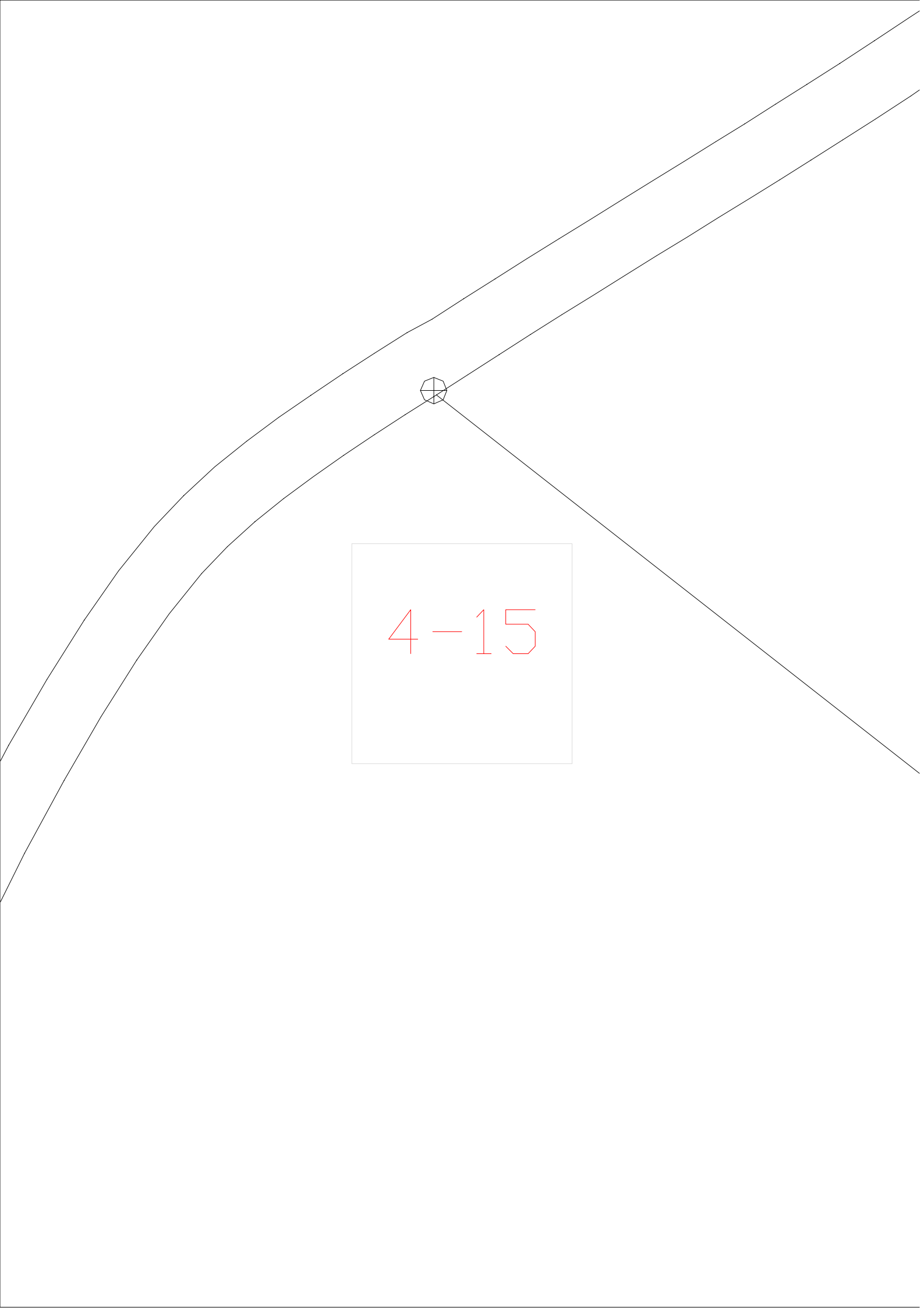

4-15



4-16



4-17

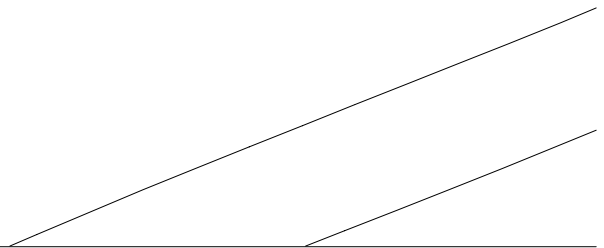
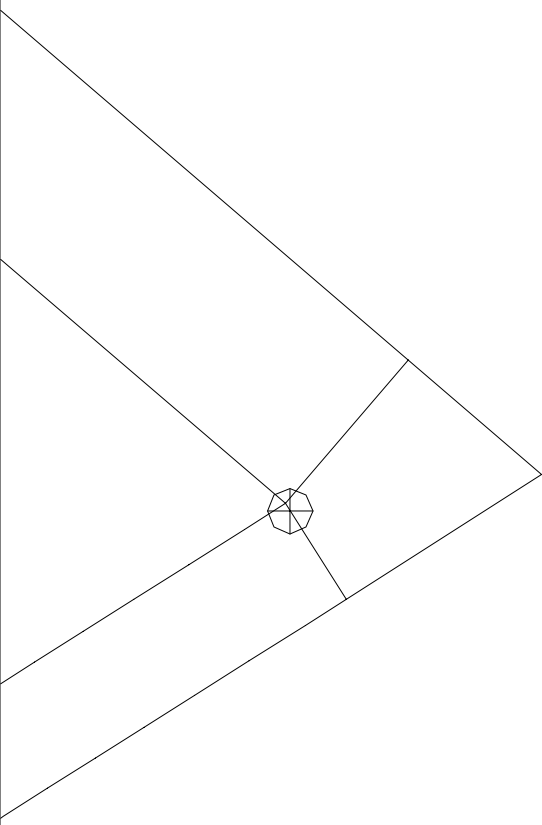

4-18

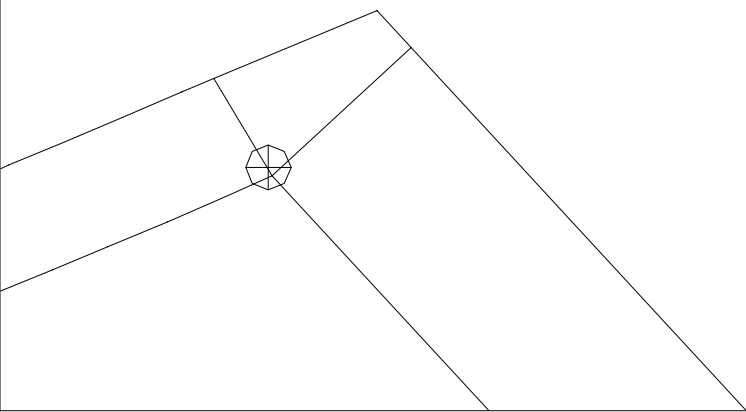
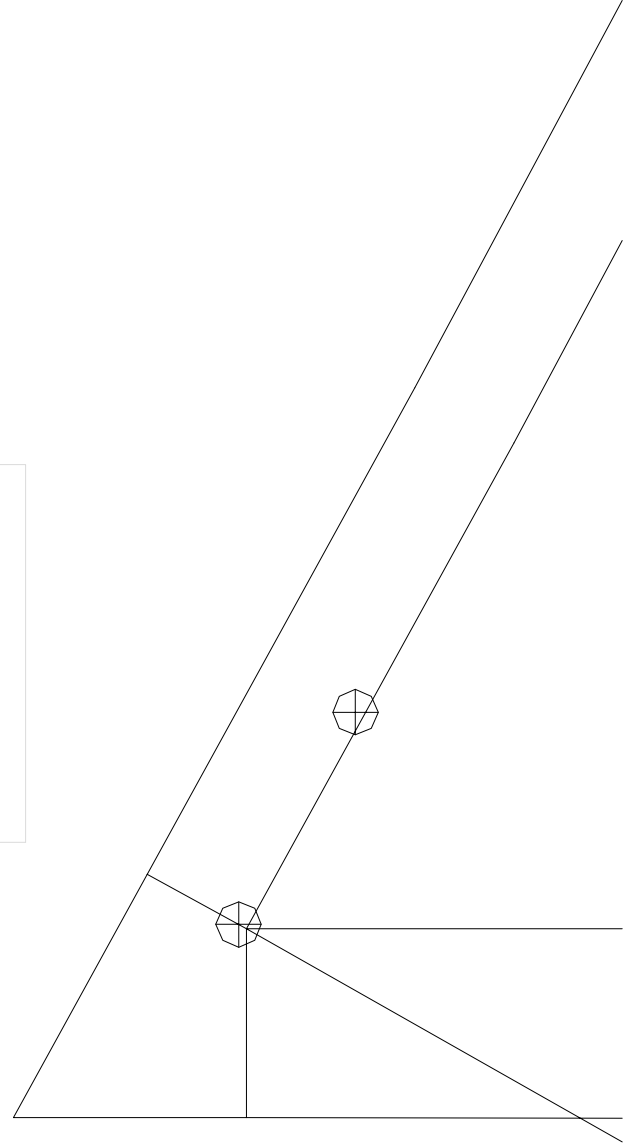

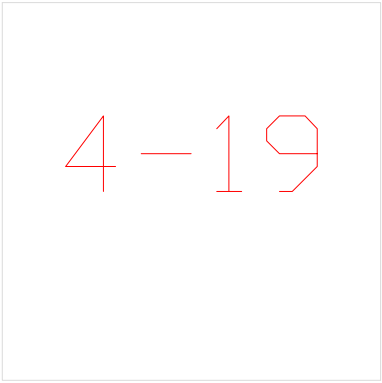

4-19

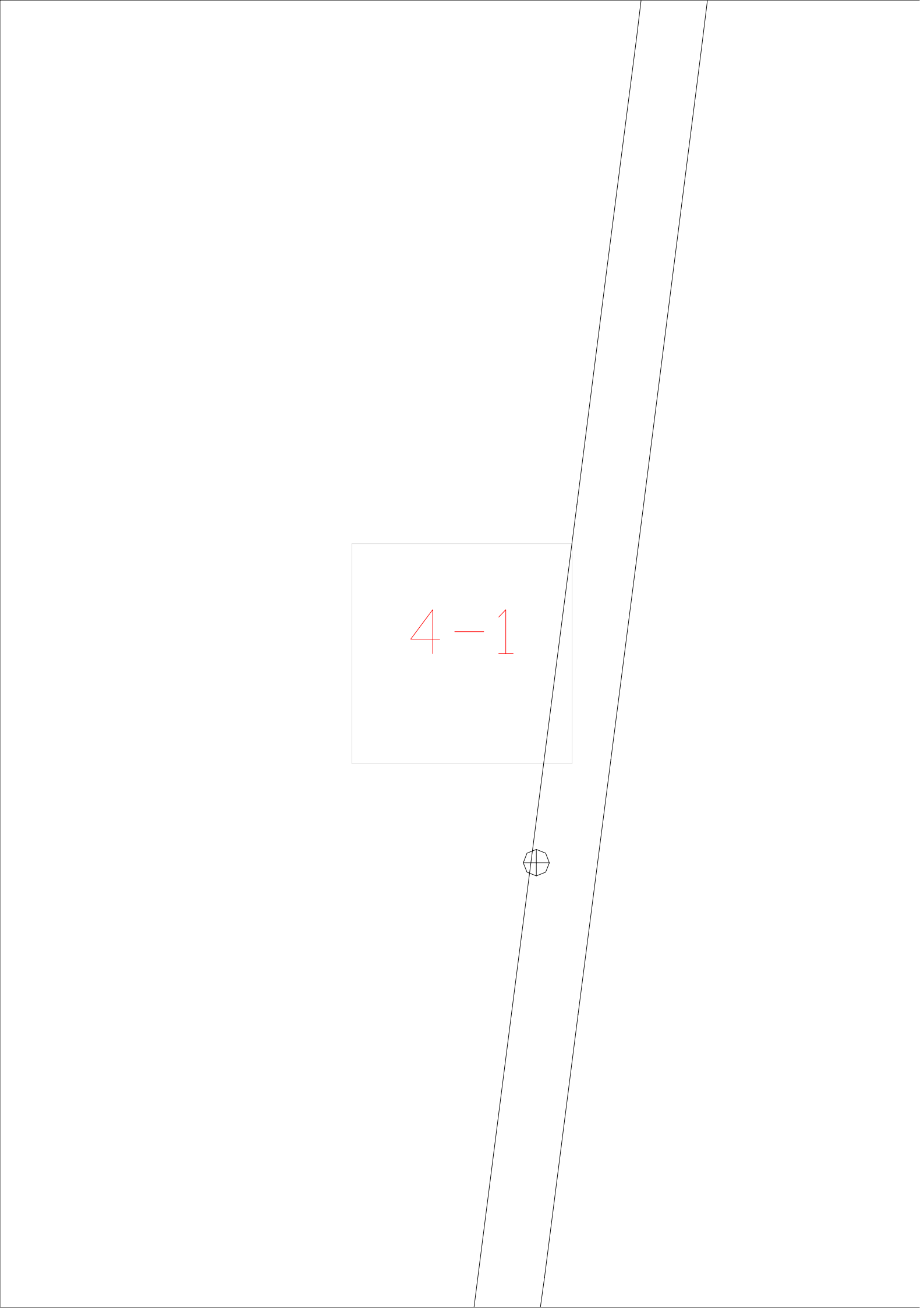

A diagram showing a vertical strip defined by two parallel lines that are slightly slanted. A light gray rectangular box is positioned in the center of the strip. Inside the box, the text "4-1" is written in red. Below the box, on the left boundary line of the strip, there is a small black hexagonal marker with a cross inside it.

$$4 - 1$$



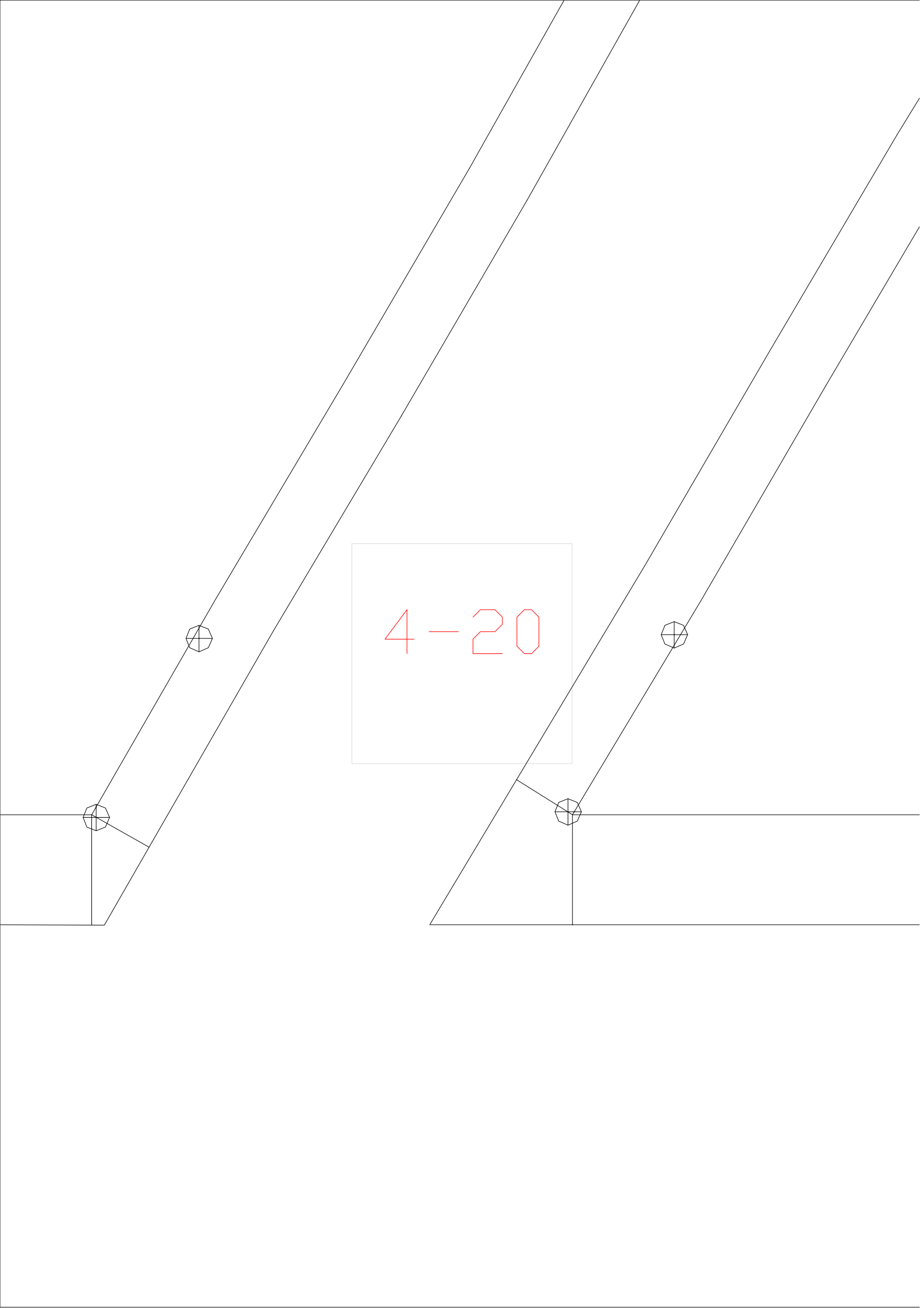

4-20

4-21

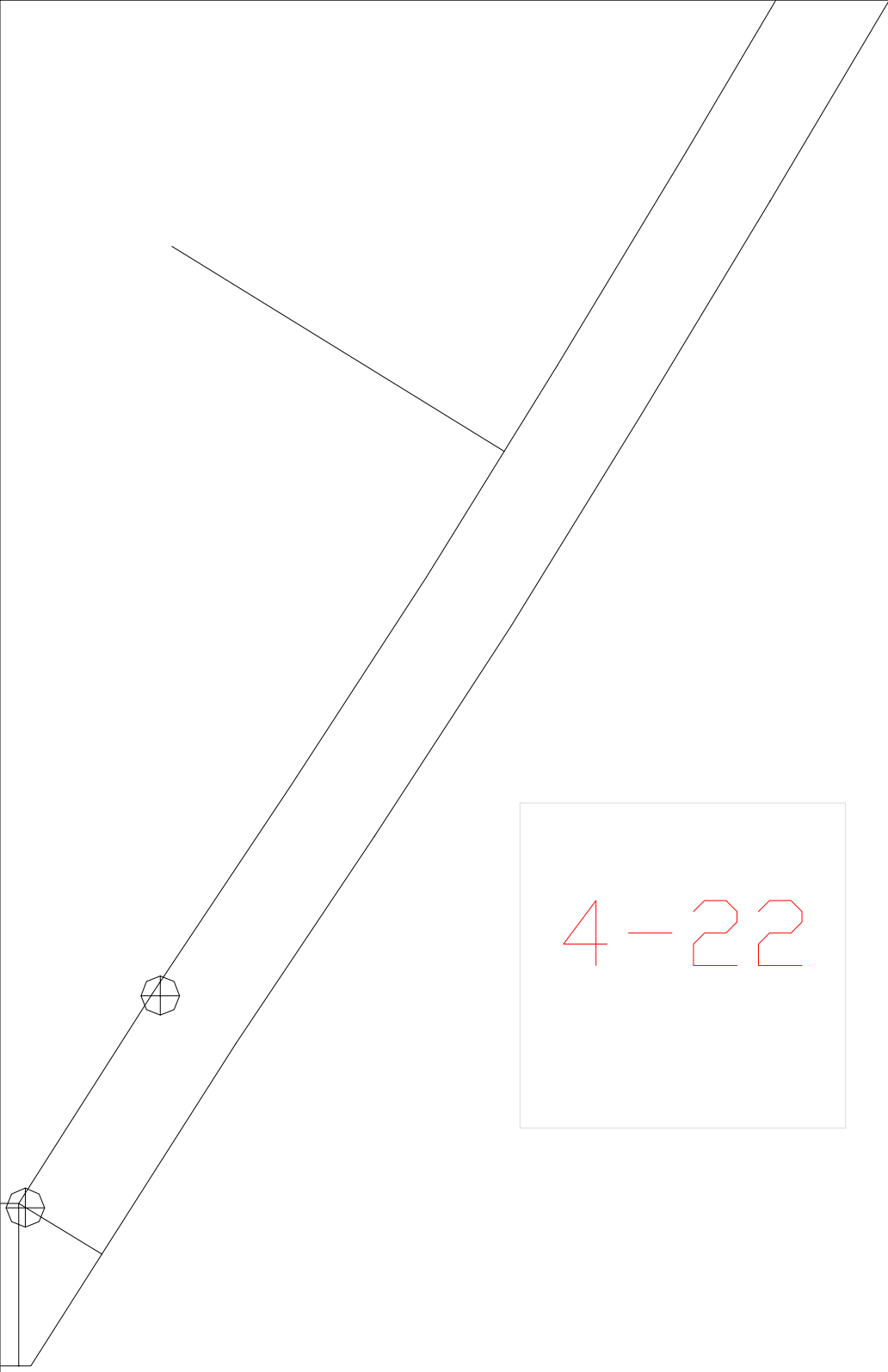

4-22

4-23

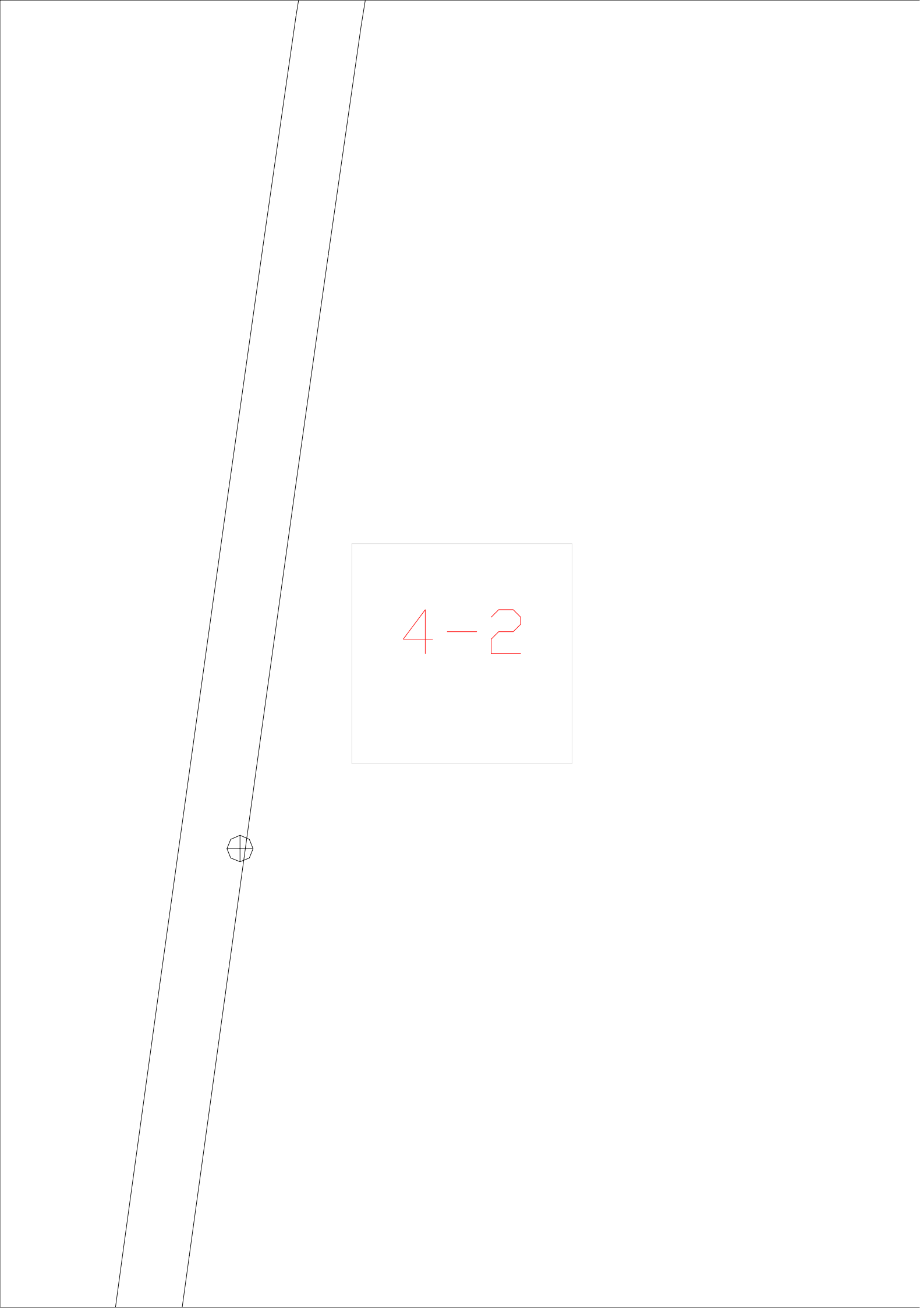
 $4-2$

$$4 - 3$$



The image shows a technical drawing of a component with two vertical channels. Each channel contains a bolt. In the center, there is a rectangular box containing the equation  $4 - 4$ .

$$4 - 4$$

4-5



4-6





4 - 7

4 - 8



4-9

5-10



5-11

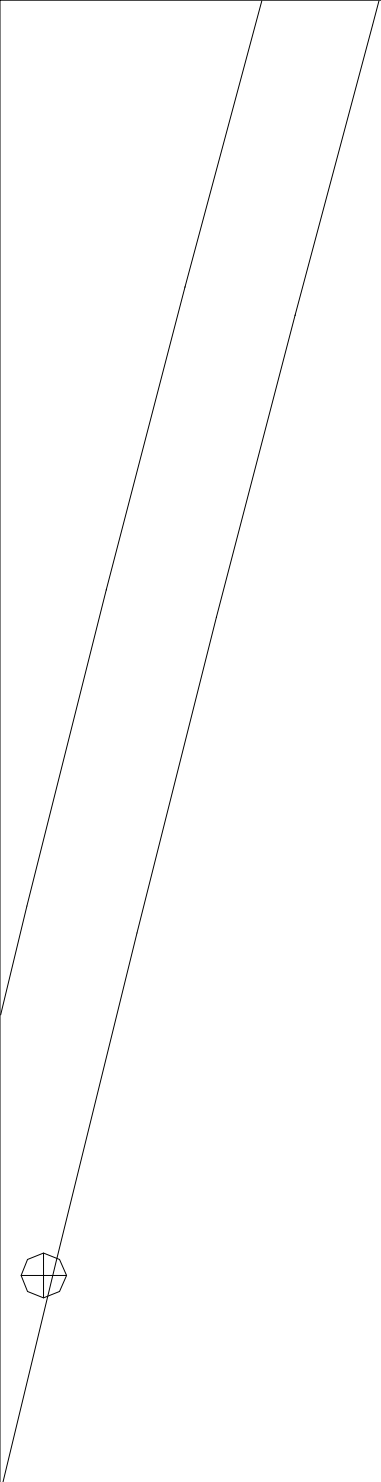

5-12

5-13





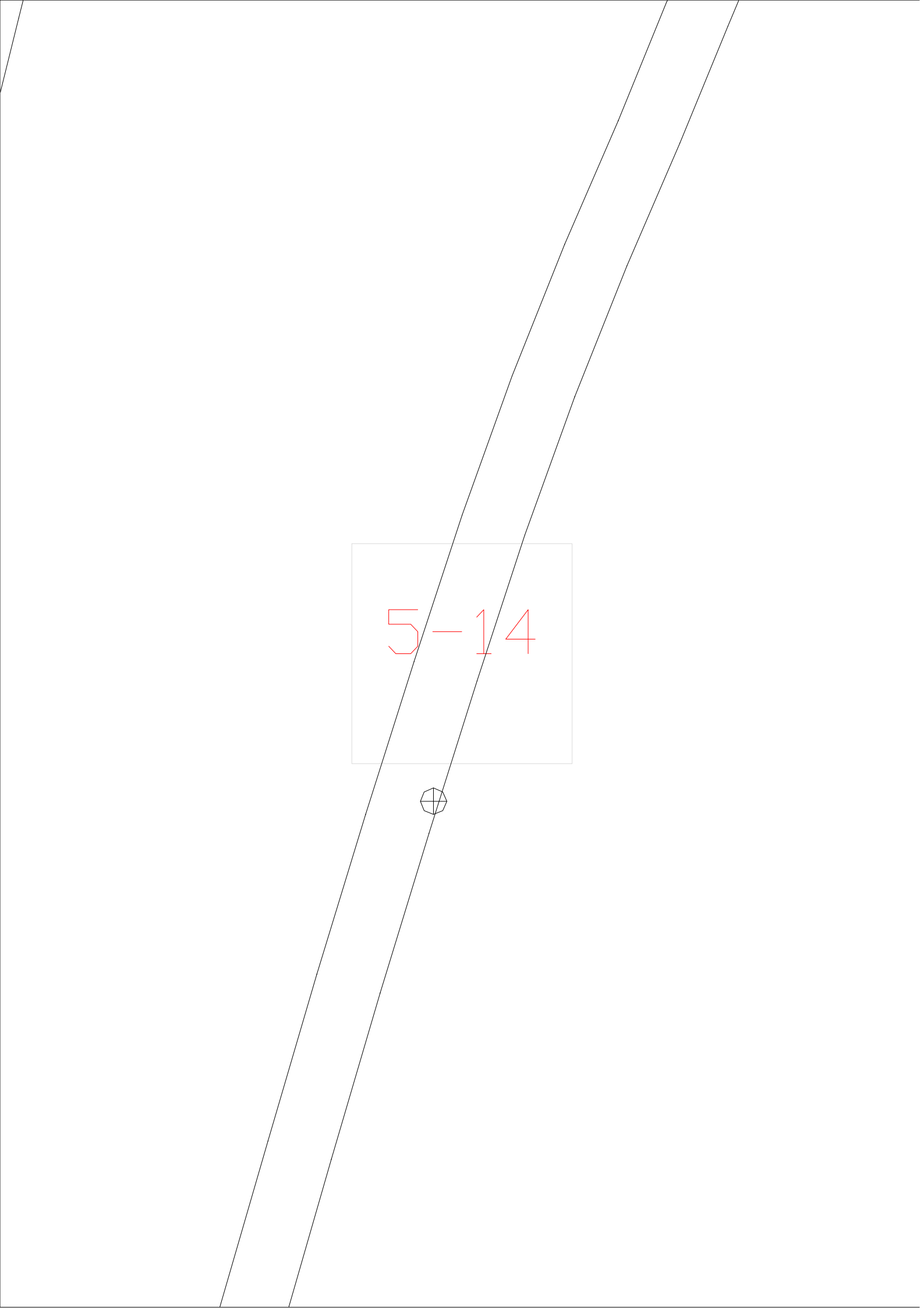

5-14

The image shows a technical drawing of a tapered shaft. The shaft is represented by two parallel lines that converge from left to right, indicating a taper. A circular hole is shown on the shaft, with a cross-section symbol consisting of a circle with a vertical line and a horizontal line. A rectangular box is drawn around the shaft, containing the text '5-14' in red. The box is positioned such that it encompasses the hole and the tapering section of the shaft.

5-15

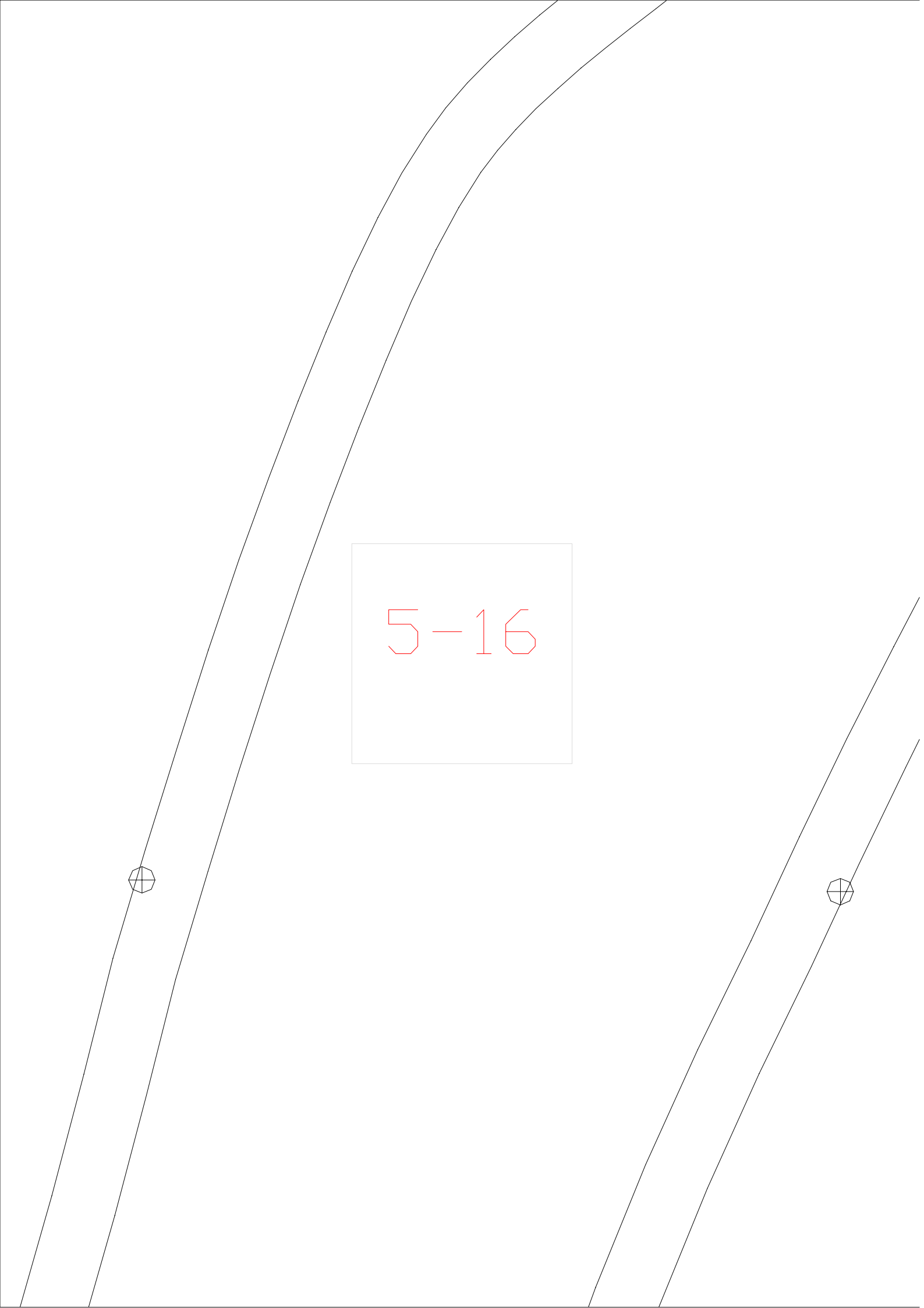
The diagram features two sets of curved lines that sweep upwards from the bottom left towards the top right. Each set consists of two parallel lines. On the left set, a small octagonal symbol with a cross inside is positioned on the upper line. A similar symbol is on the lower line of the right set. In the center, a light gray rectangular box contains the text '5-16' in red.

5-16

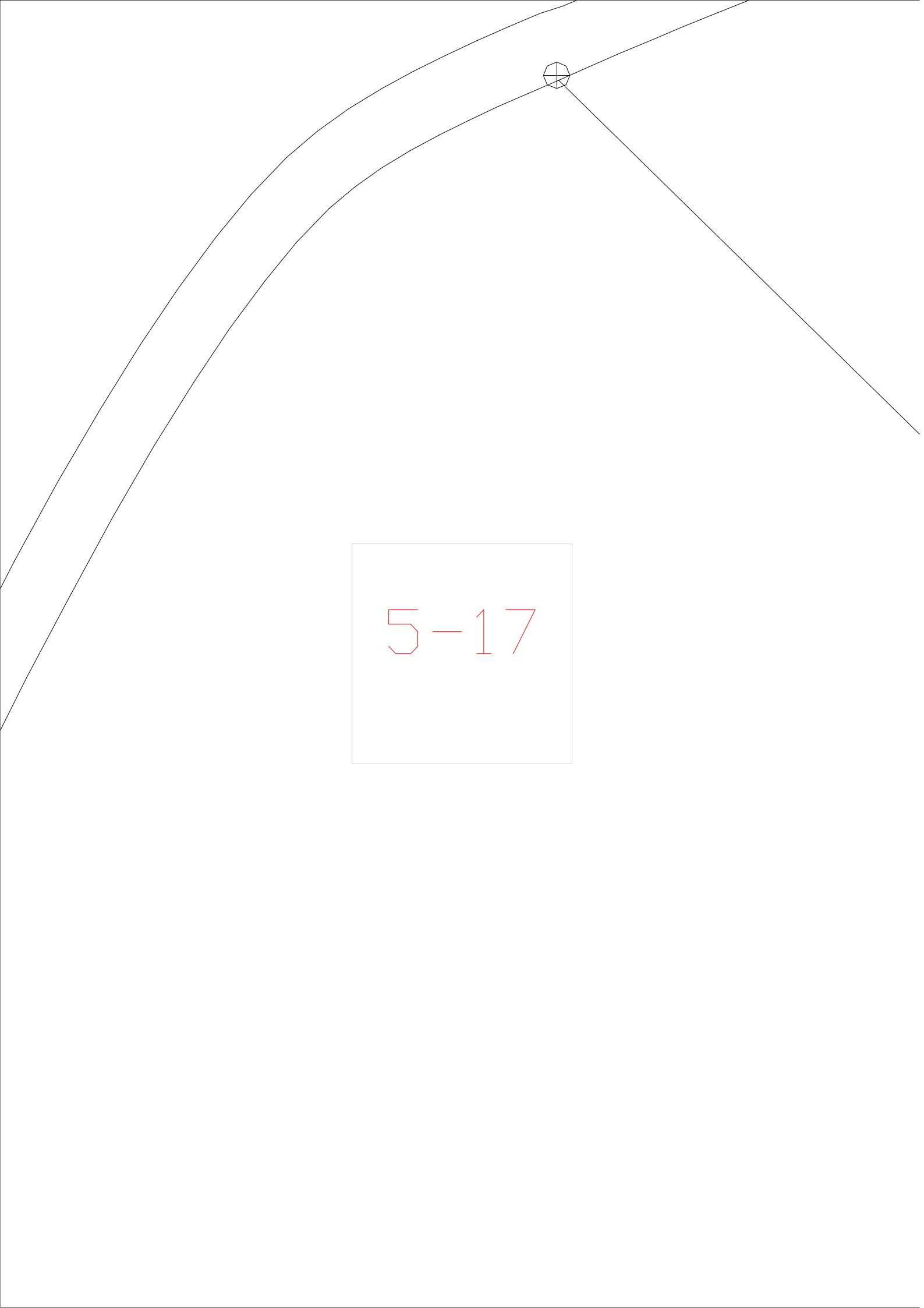

5-17

5-18



5-19

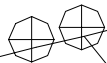

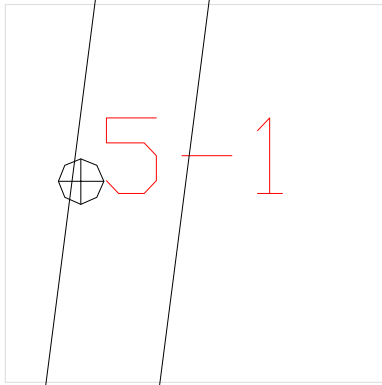

5-20

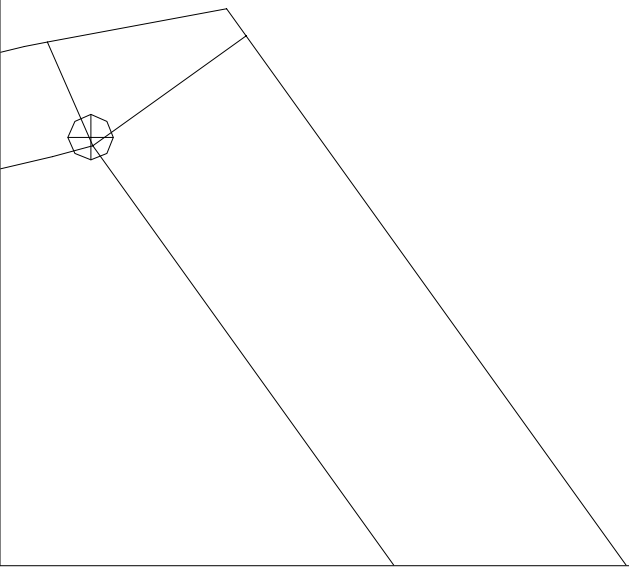



5-21

5-22

5-23



5-2

5-3



5-4



5-5

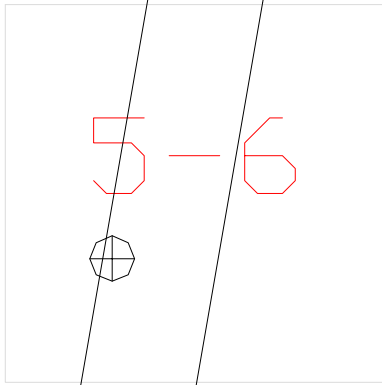



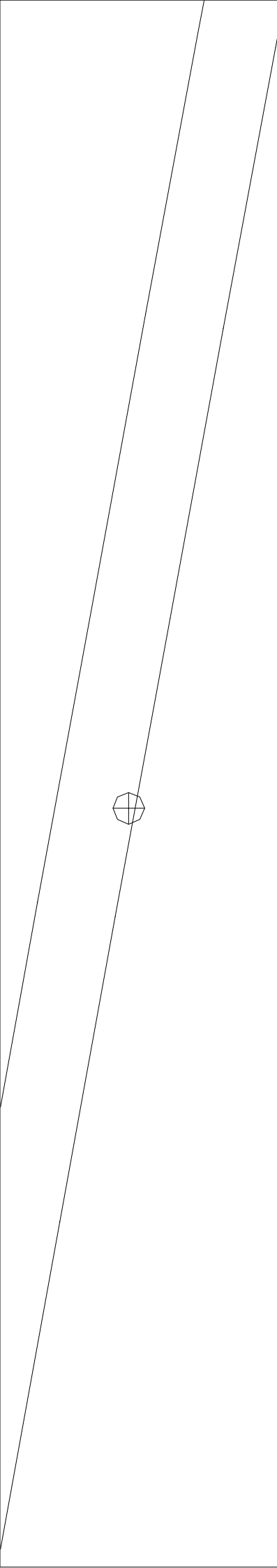

5-7

5-8



5-9



6-10



6-11

6-12



6-13

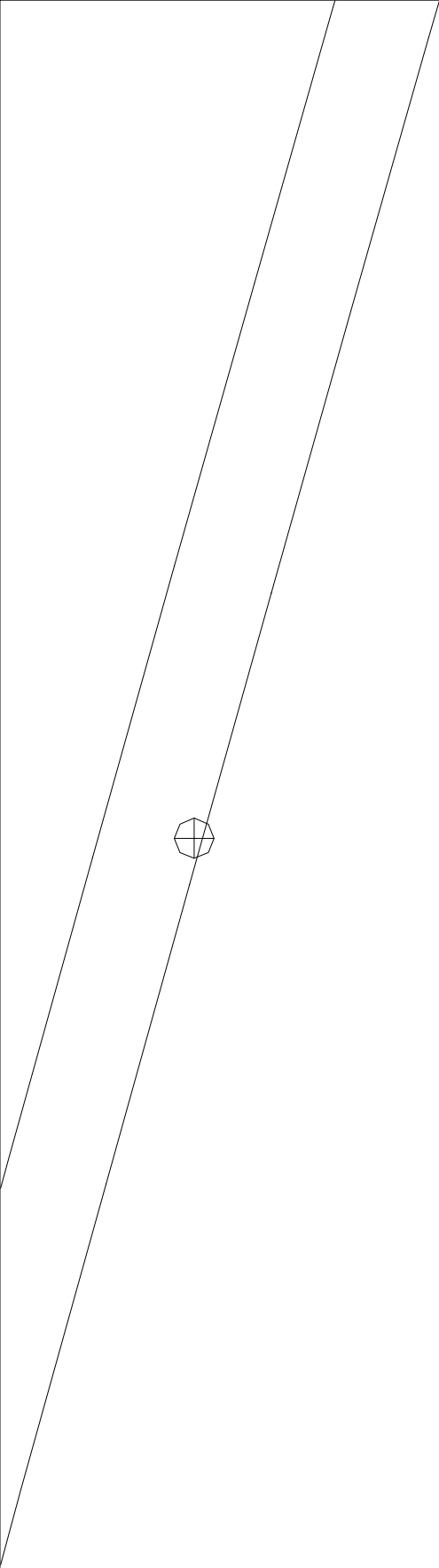

6-14



6-15



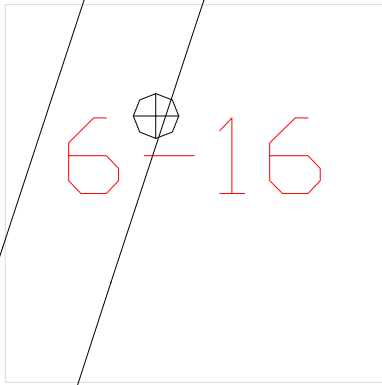

6-17

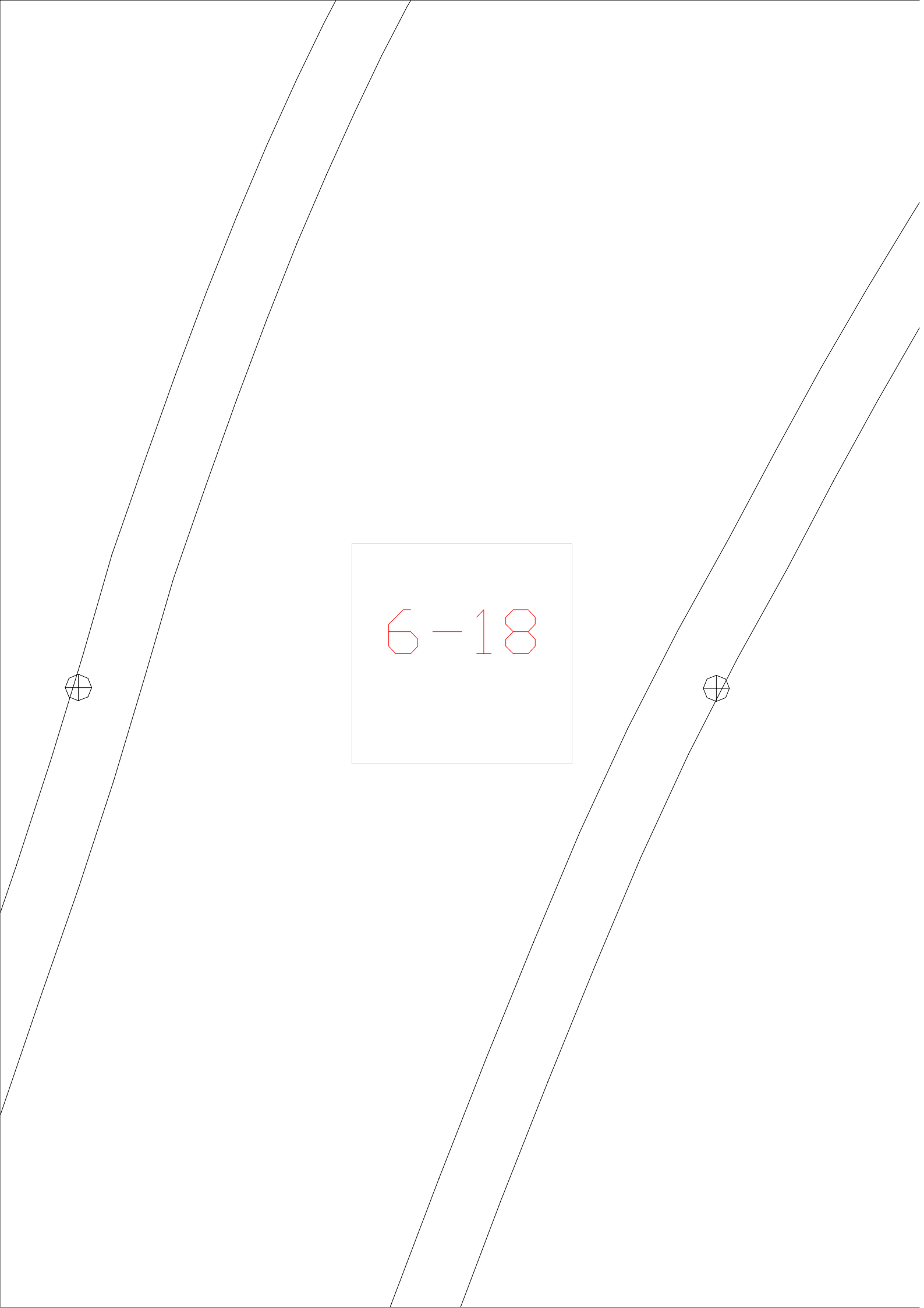

6-18

6-19



6-1

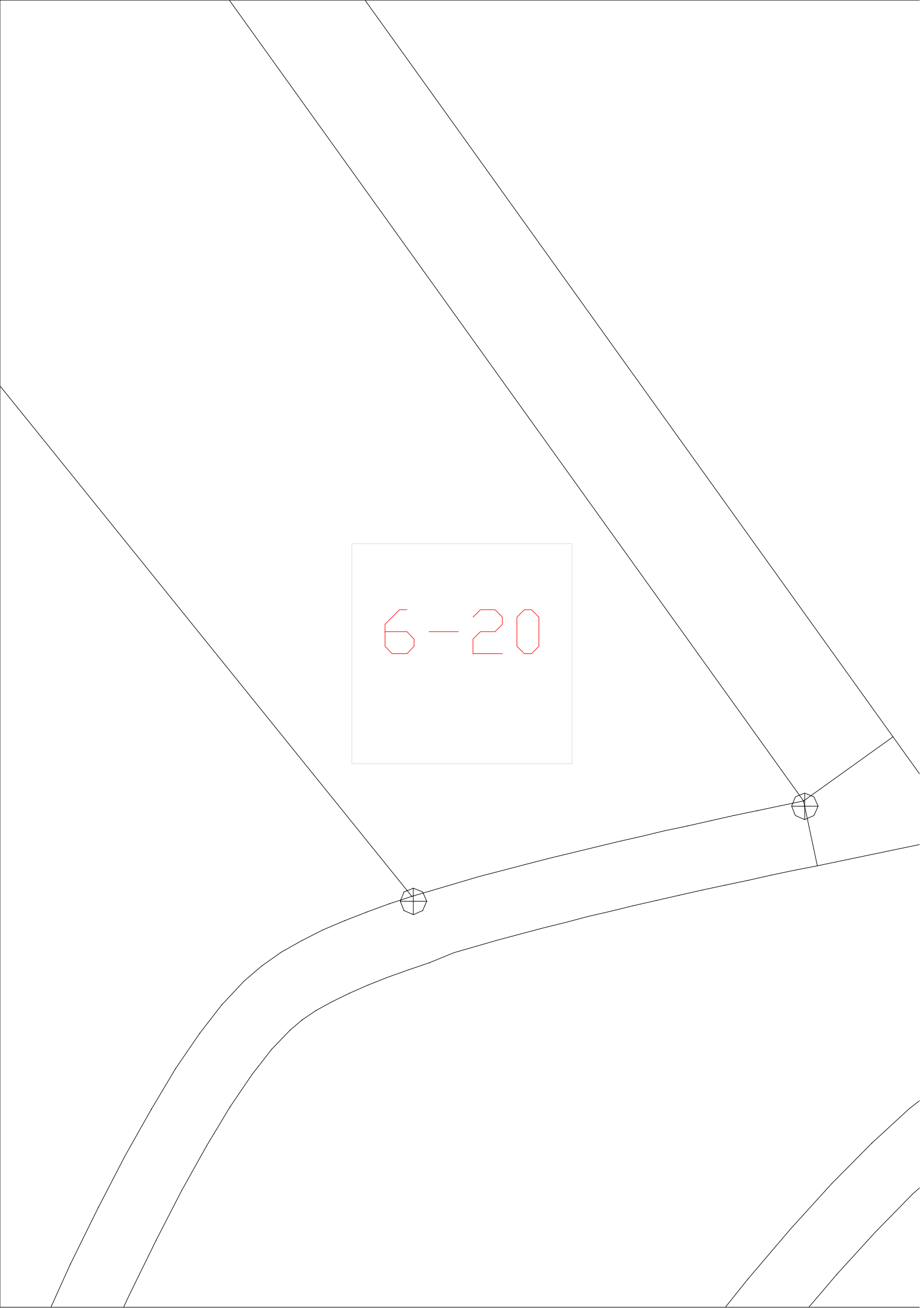

6-20

The image shows a technical drawing of a roof plan. It features several lines representing roof slopes and boundaries. A central rectangular area contains the text '6-20' in red. Two circular markers with crosshairs are positioned on the drawing, one near the bottom center and another near the right side, likely indicating specific points of interest or structural details.

6-21

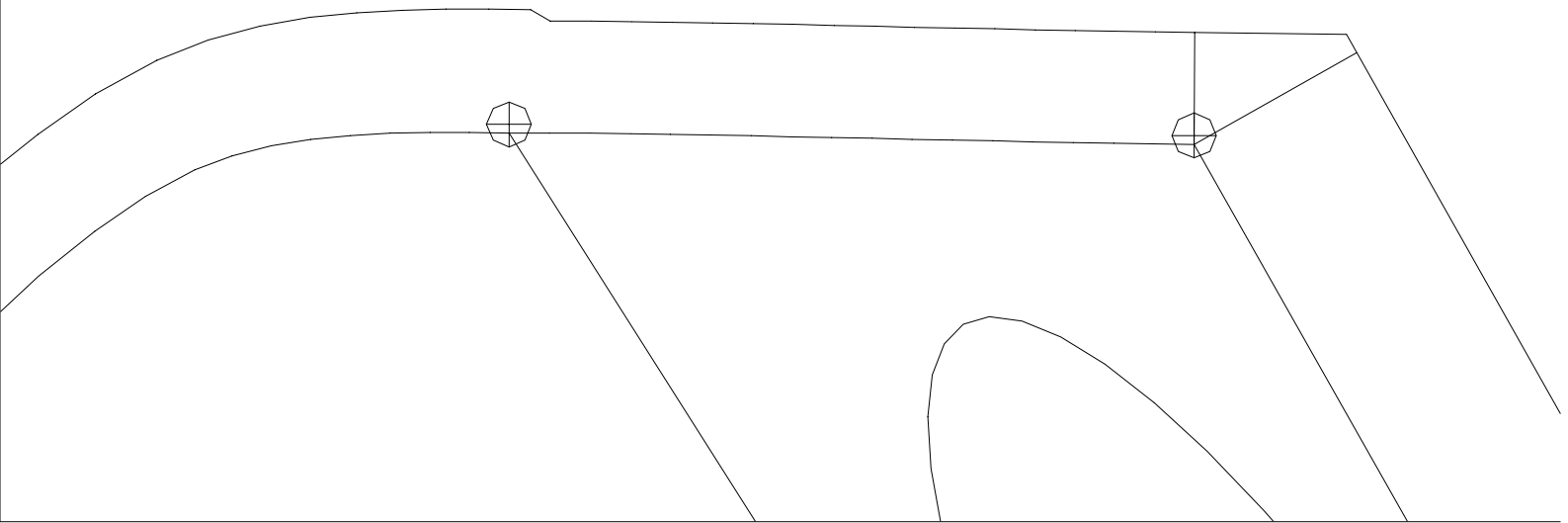



6-22

6-23

6-2

6-3





6-4

6-5



6-6

6-7



6-8





6-9

7-10





7-11

7-12



7-13

7-14



7-15



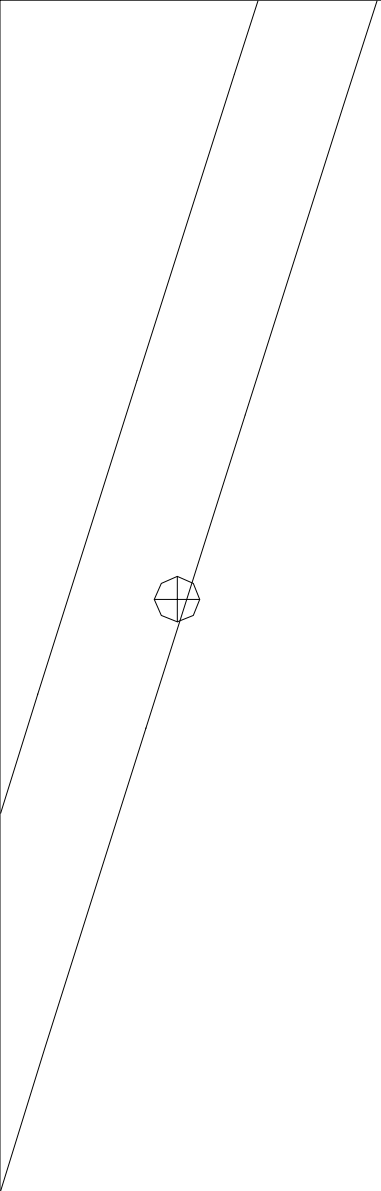

7-16

7-17





7-18

7-19





$$7 - 1$$



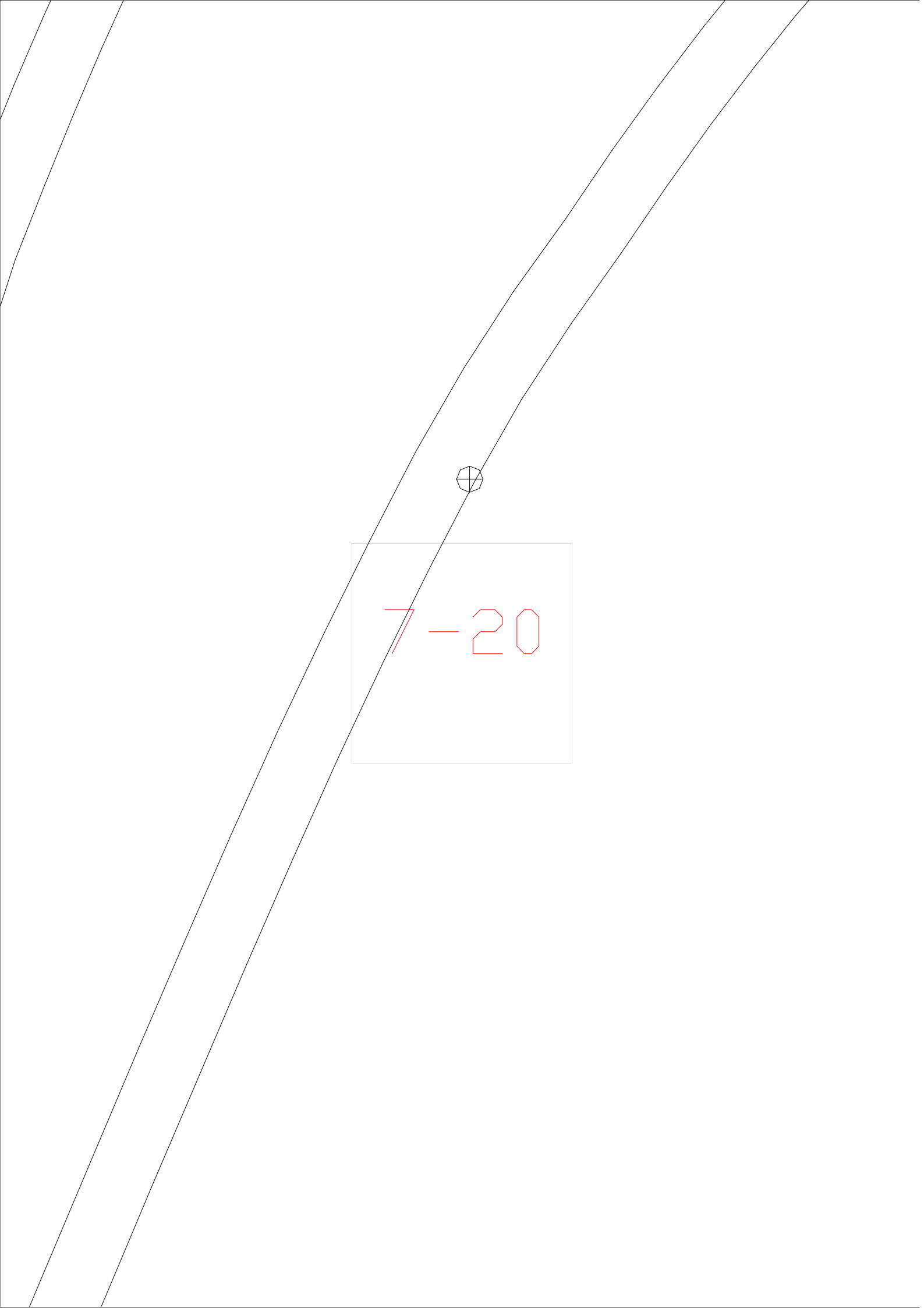

7-20

7-21

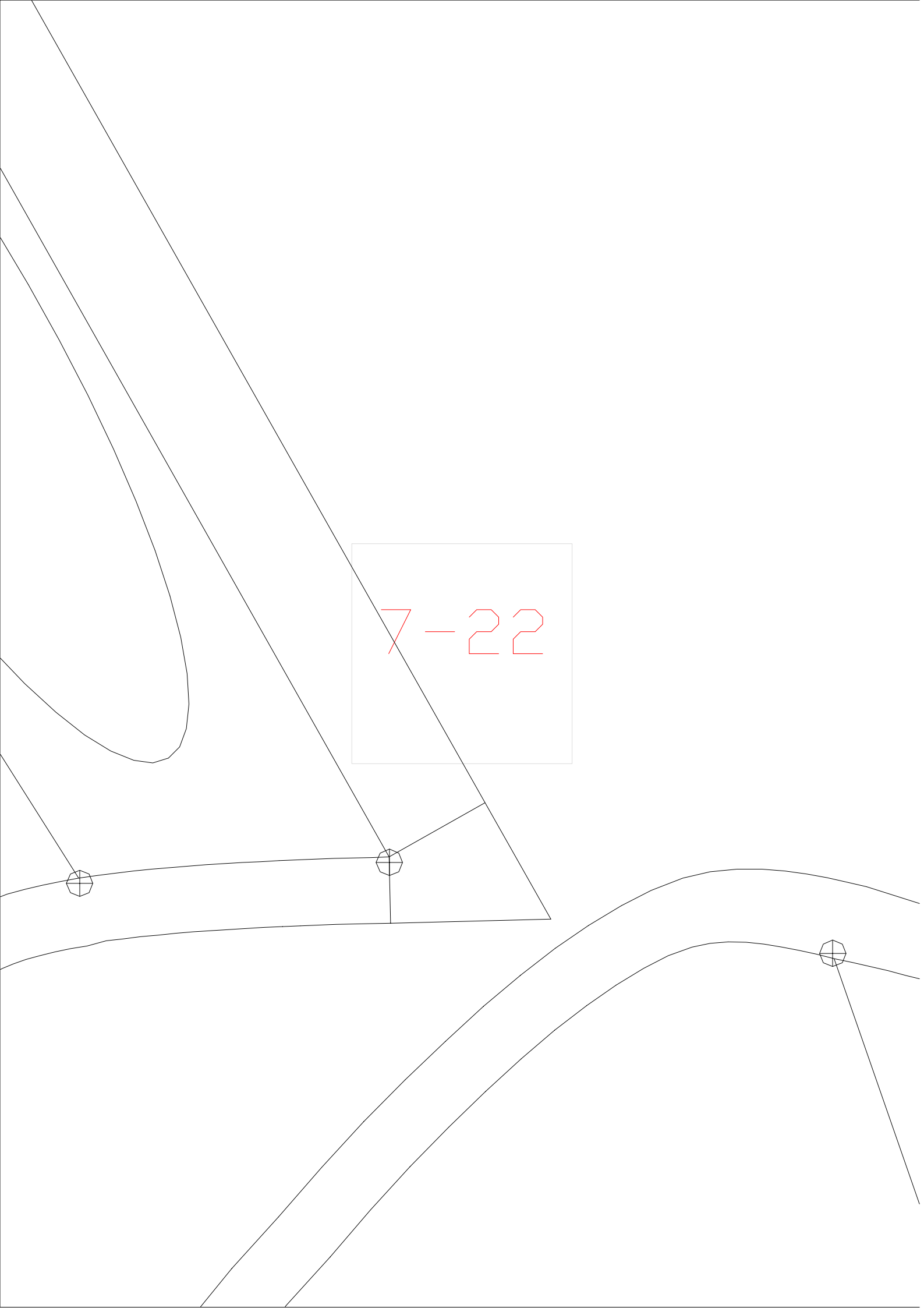

7-22

The image shows a technical drawing of a mechanical part. The part is a long, thin, curved component with a central rectangular feature. The drawing is composed of several lines: a top curved line, a bottom curved line, and a central vertical line. The central vertical line is connected to the top and bottom lines by diagonal lines. The central rectangular feature is outlined in red and contains the text '7-22' in red. There are three small circular features with crosshairs: one on the left side, one in the center of the top line, and one on the right side of the bottom line. The drawing is a line drawing with no shading or color.



7-23

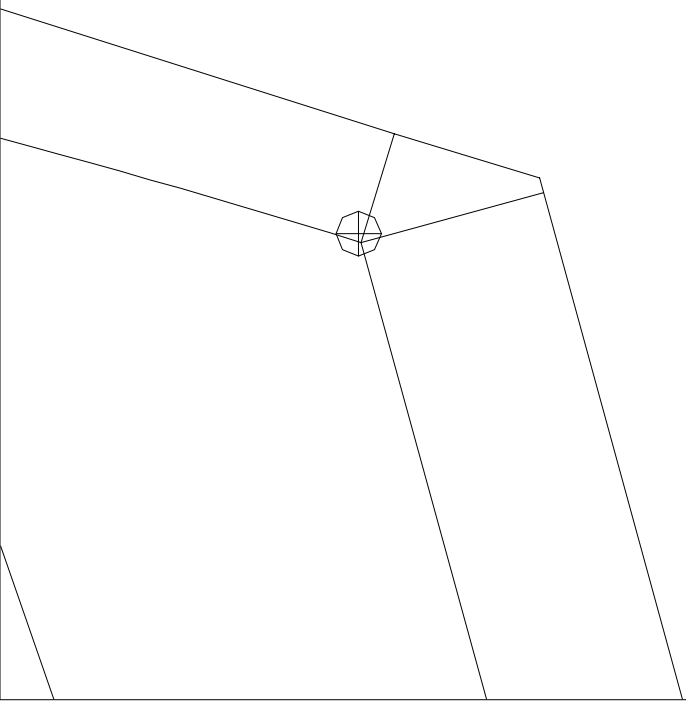

7-2

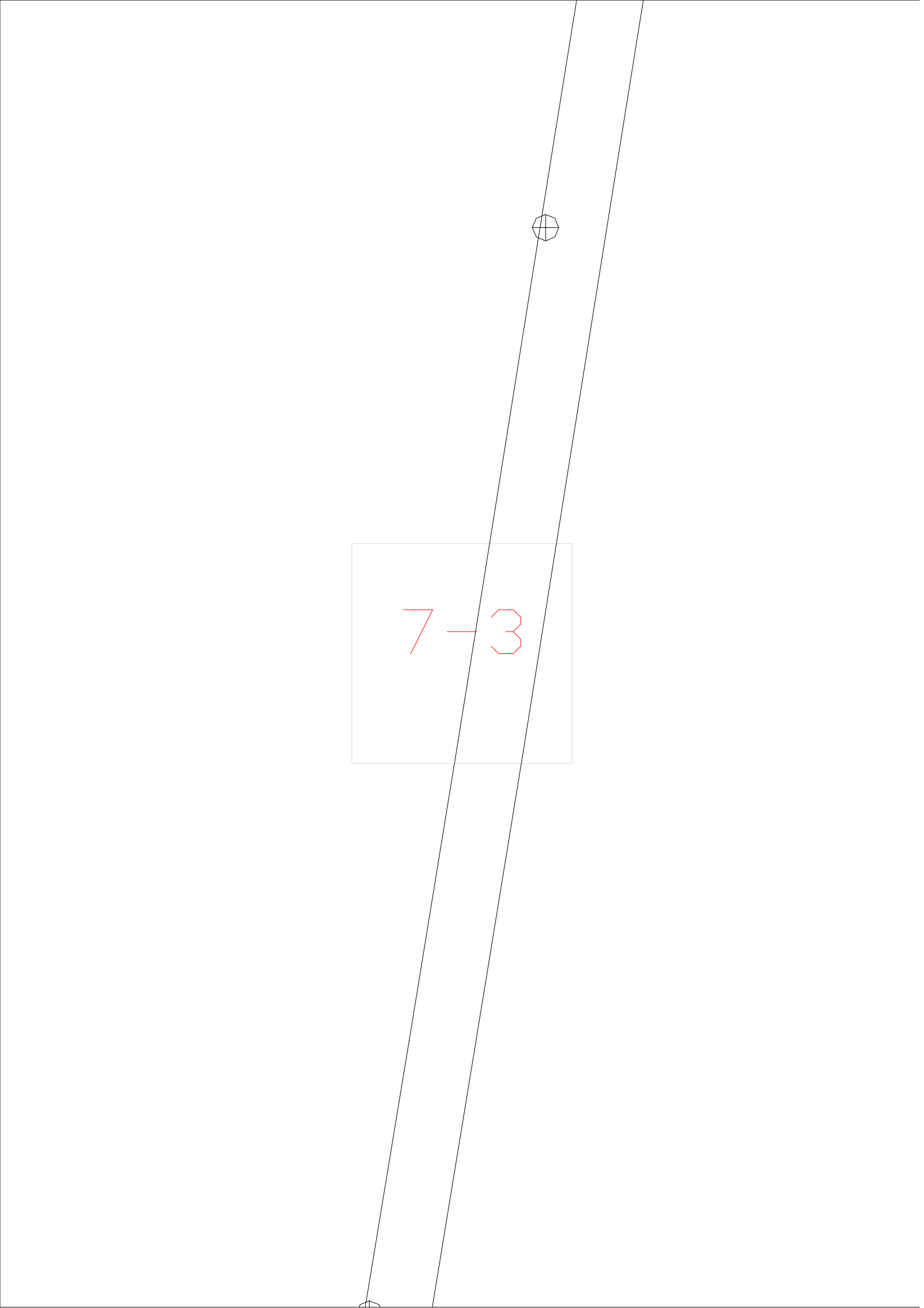

A diagram of a cylinder is shown, oriented vertically. The cylinder is represented by two parallel lines that converge towards the top, forming an elliptical shape. A small circle with a cross inside is positioned on the upper part of the cylinder. A rectangular box is drawn around the middle of the cylinder, containing the equation  $7-3$  in red text.

$$7-3$$

$$7 - 4$$

$$7 - 5$$

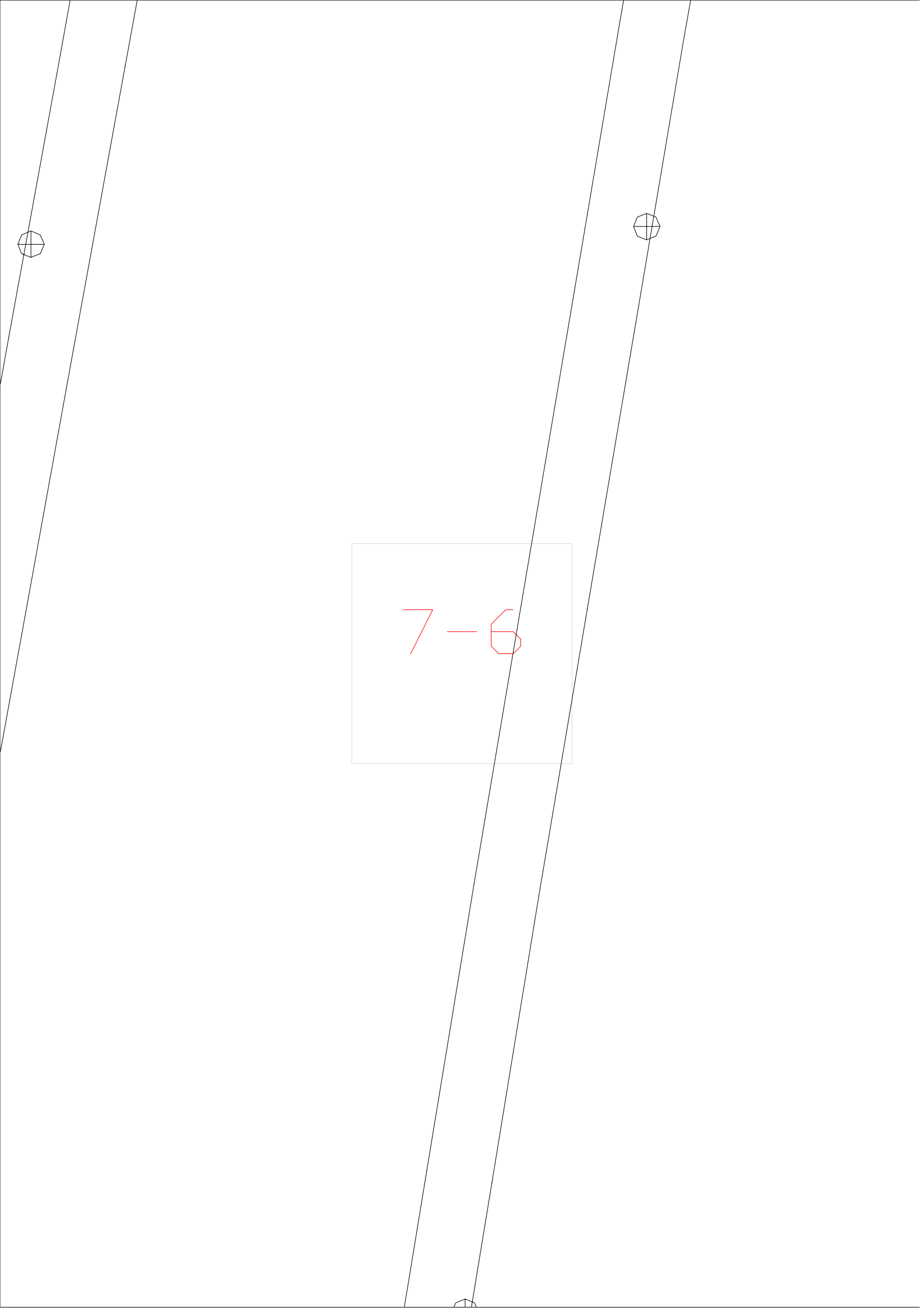

7-6

$$7 - 7$$



7 - 8





7-9

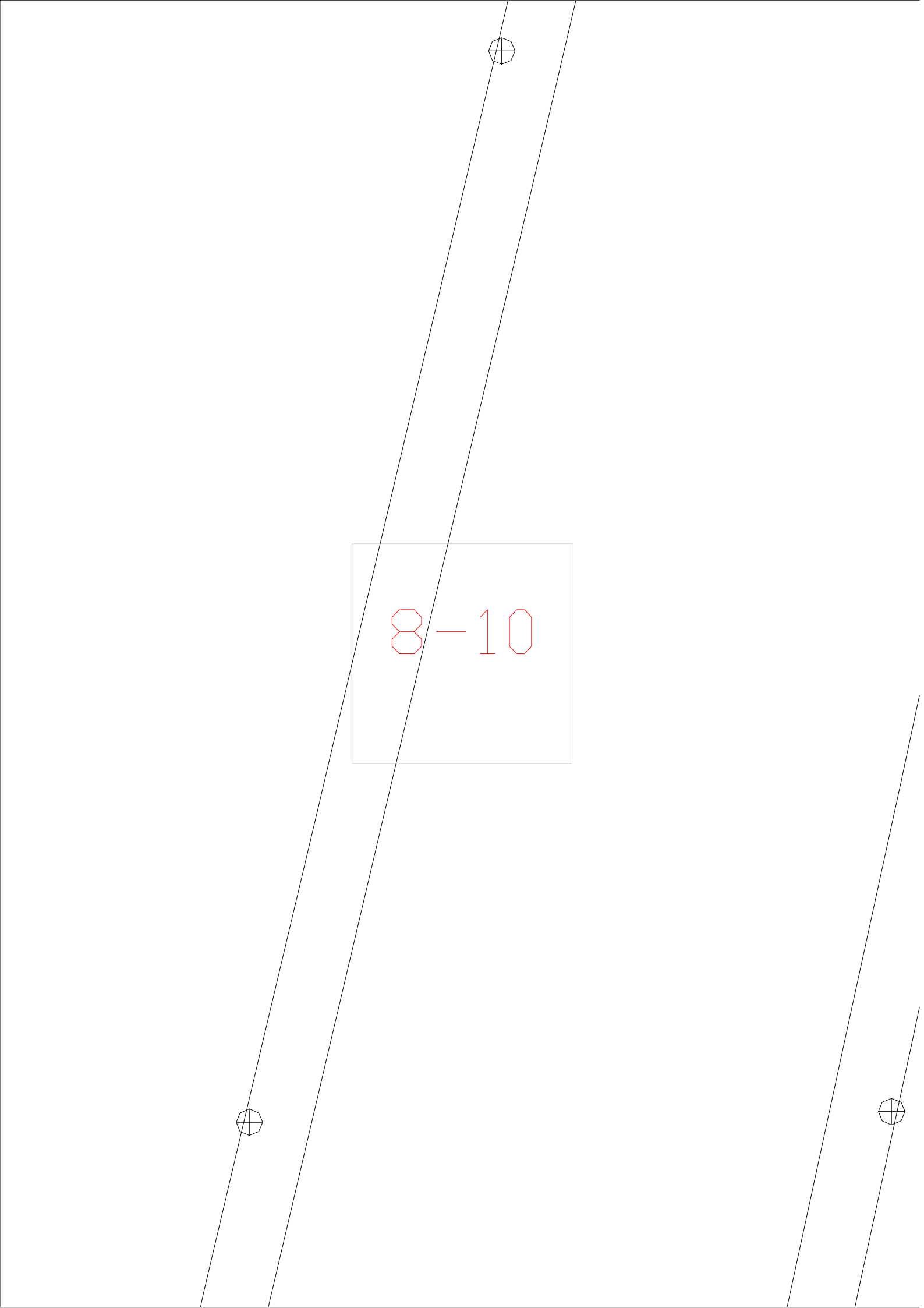

The diagram consists of two pairs of parallel lines slanted at an angle. Each line in both pairs has a small circle with a cross inside, positioned at the top and bottom of the line. A light gray rectangular box is centered between the two pairs of lines, containing the text '8-10' in red.

8-10



8-11

8-12



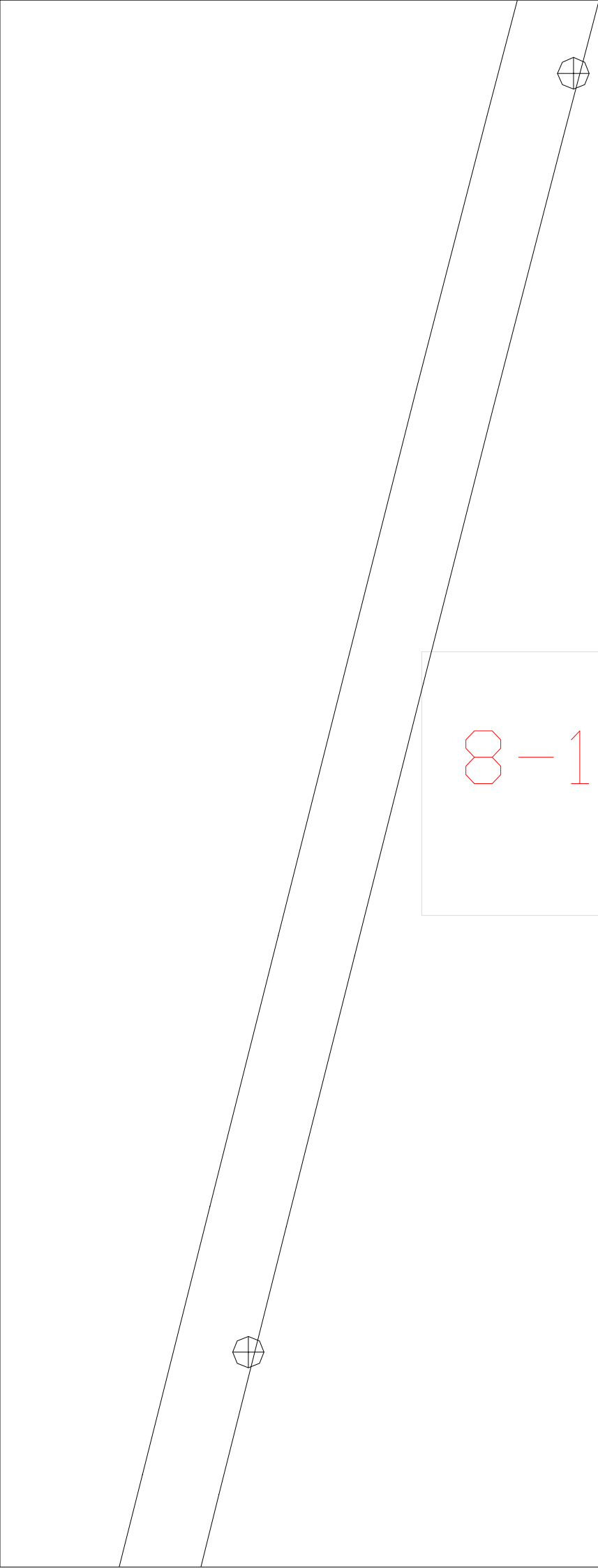

8-13

8-14





8-15



8-16





8-17



8-18

8-19

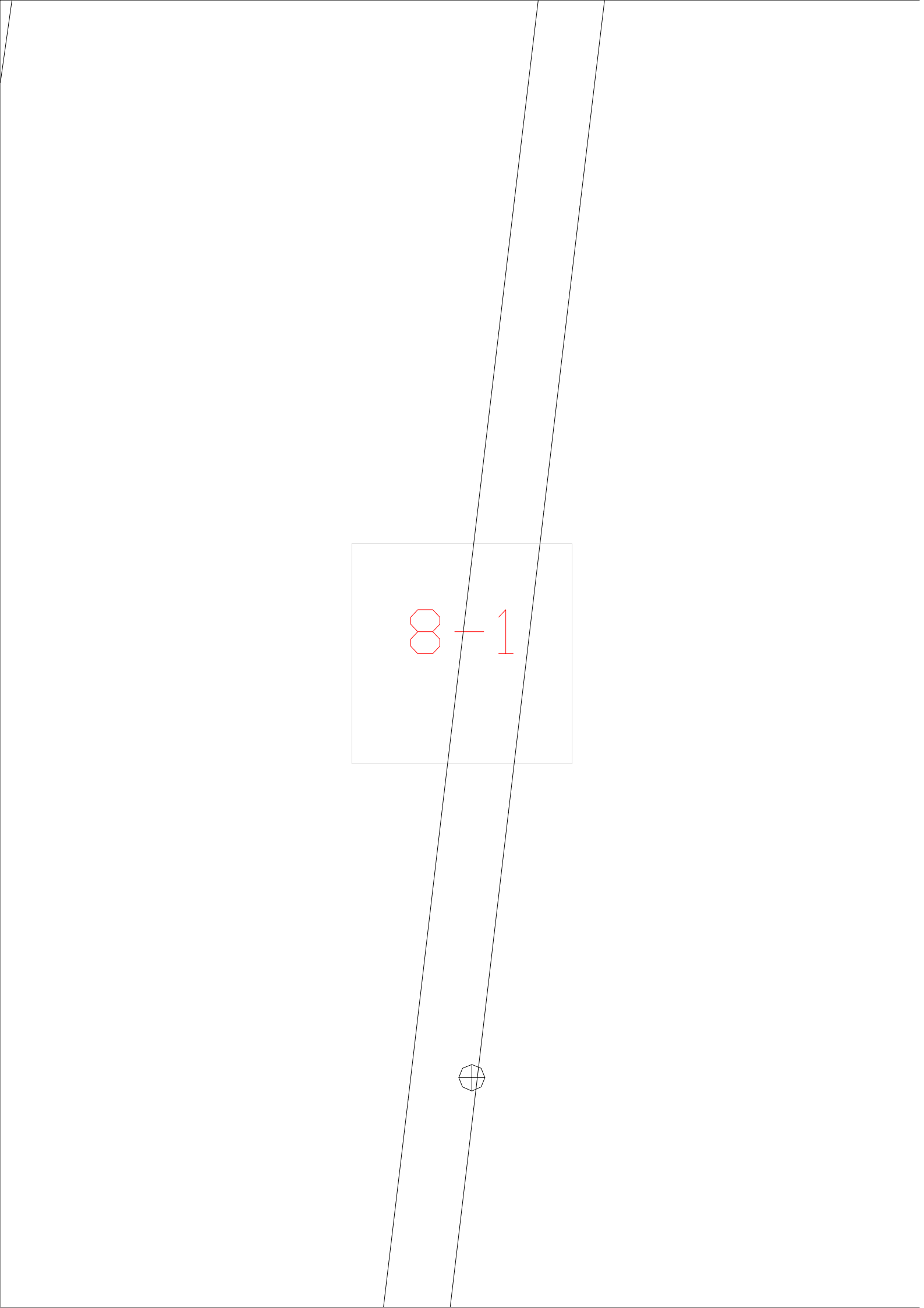

The diagram shows a vertical channel defined by two parallel lines that converge towards the top. A light gray rectangular box is centered within the channel. Inside this box, the equation  $8-1$  is written in red. Below the box, on the right-hand side of the channel, there is a small black octagonal symbol with a cross inside it.

$$8-1$$



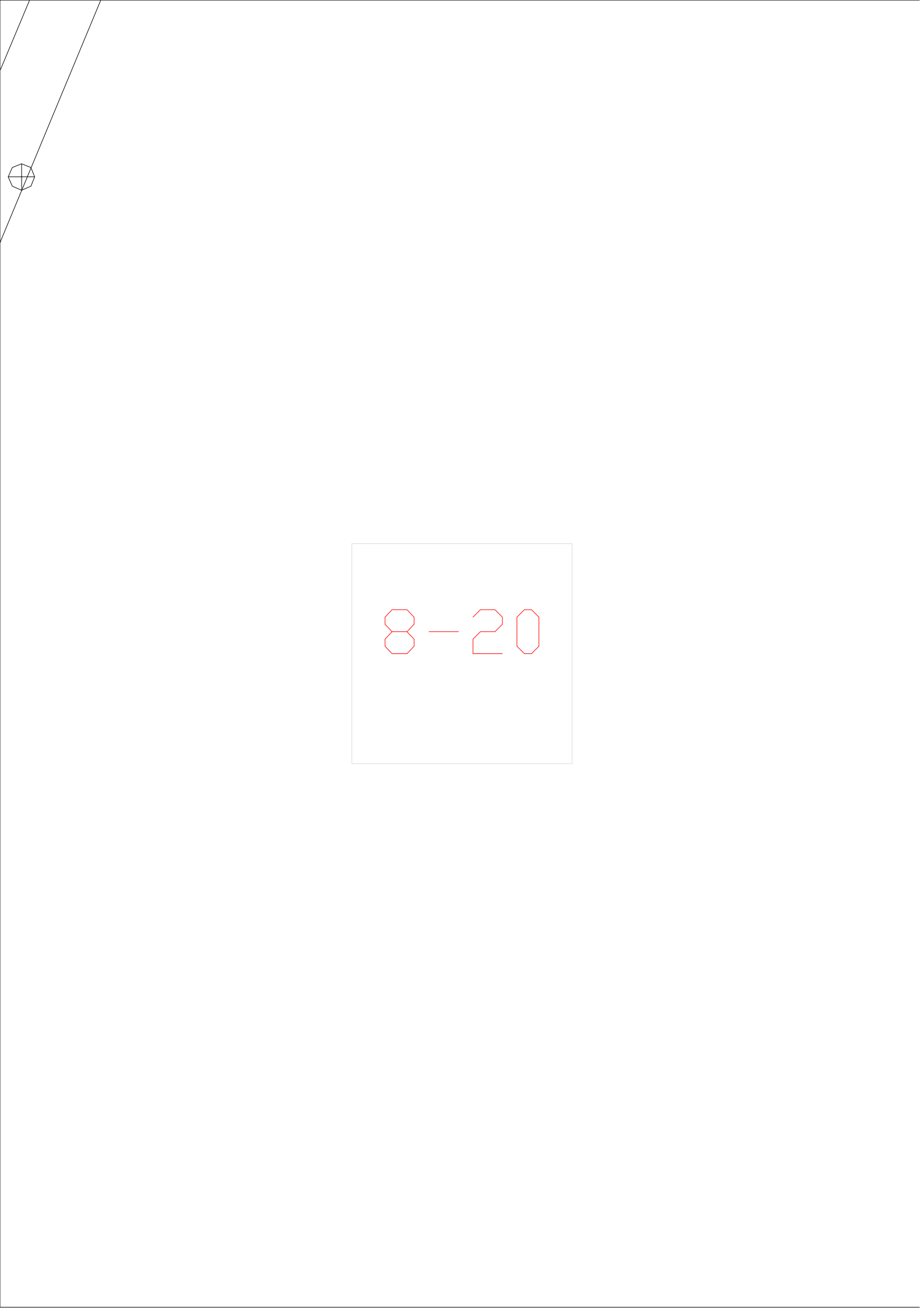

8-20

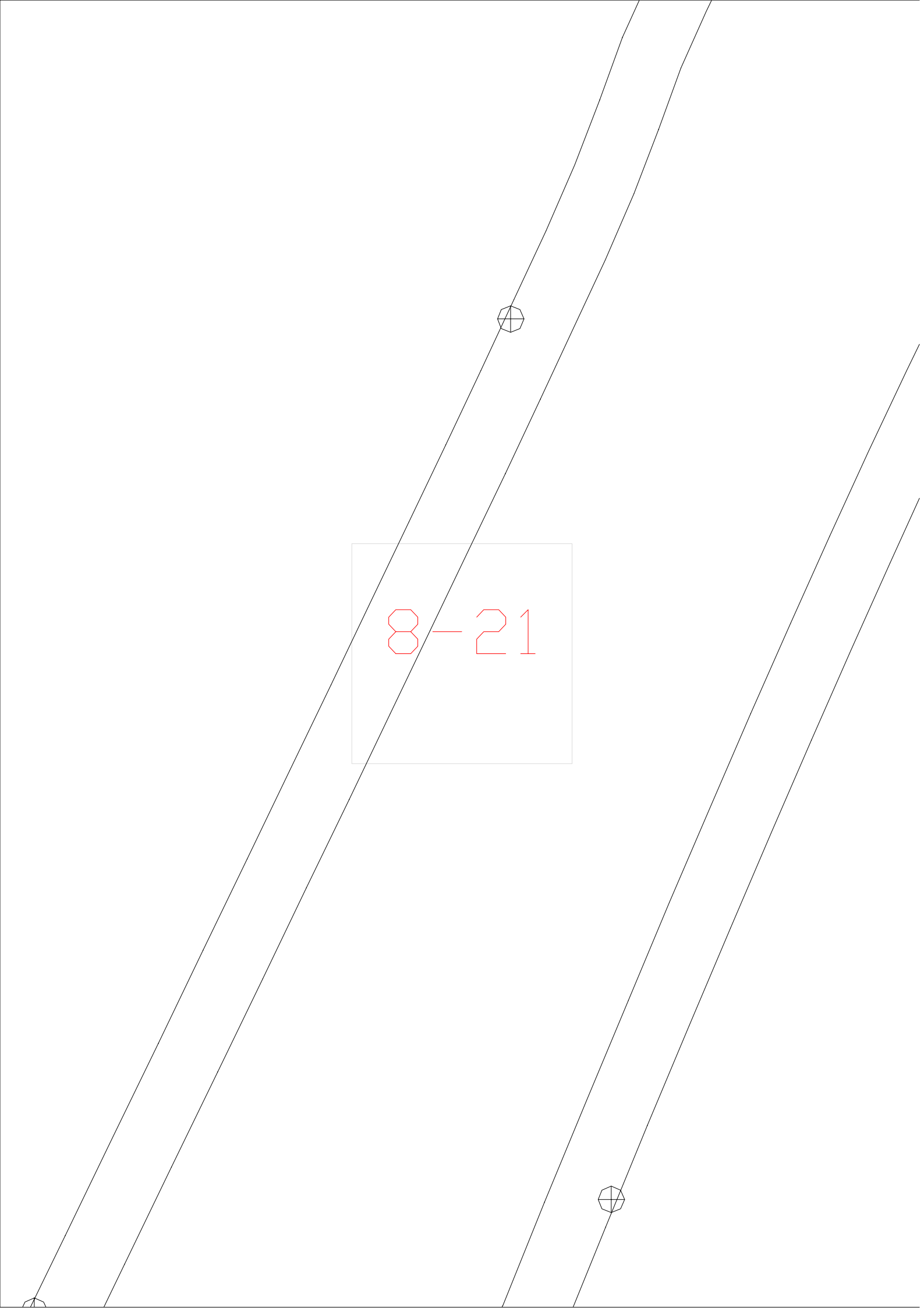

8-21

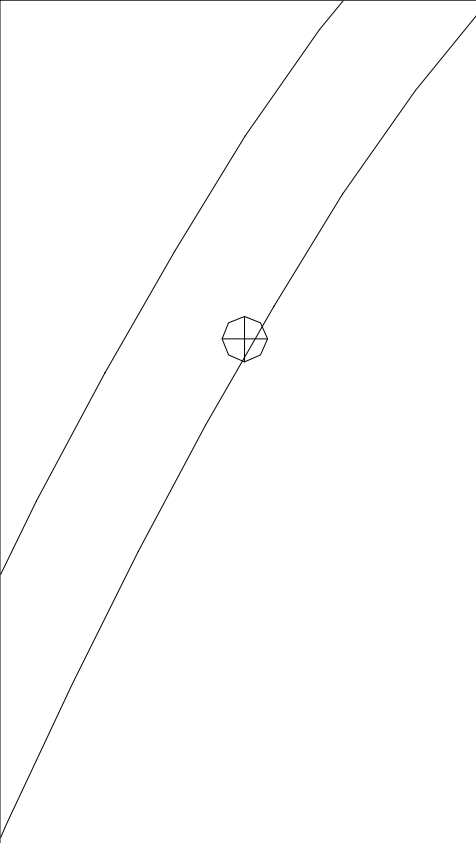

8-22

8-23

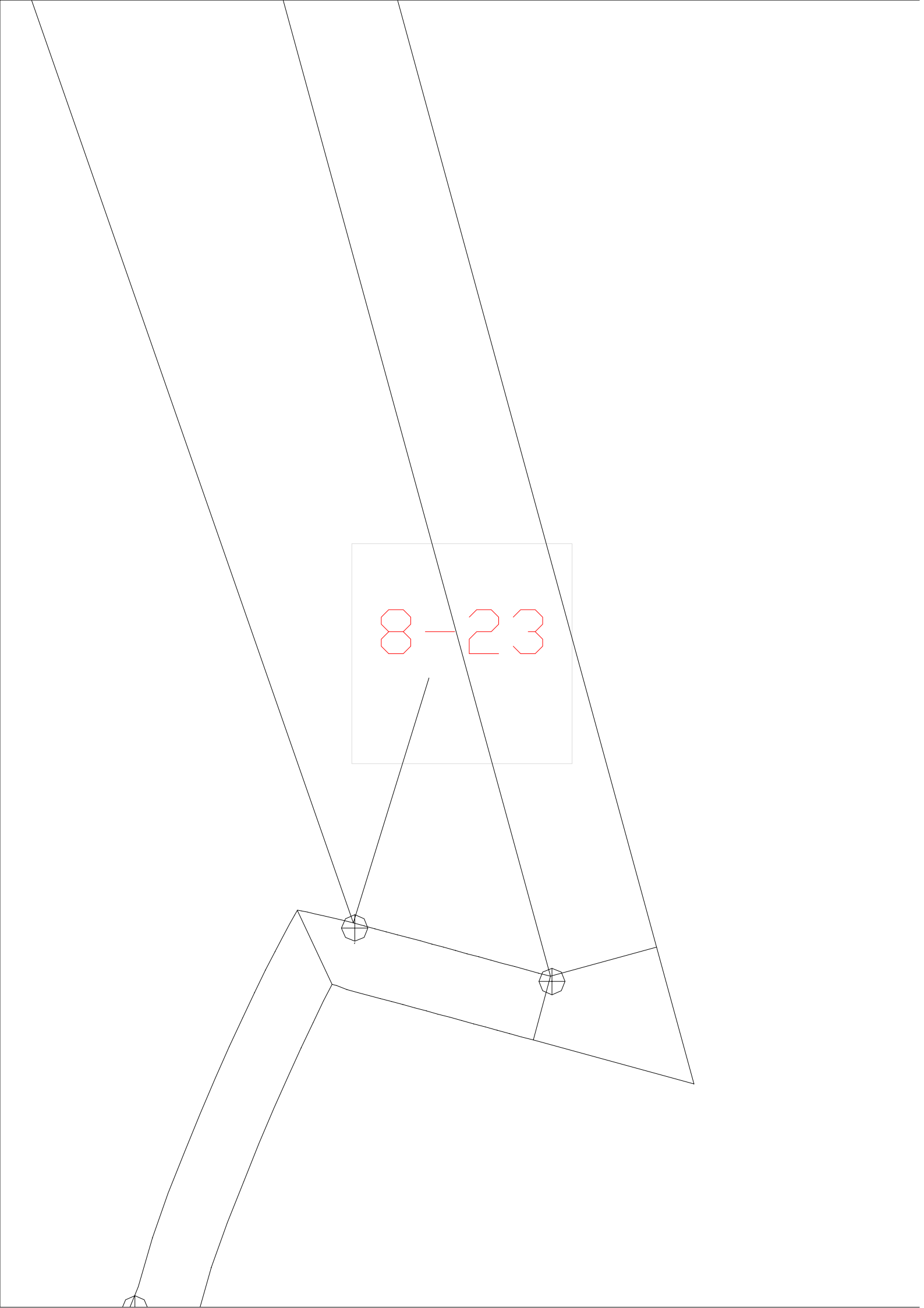



8-2

8 - 3

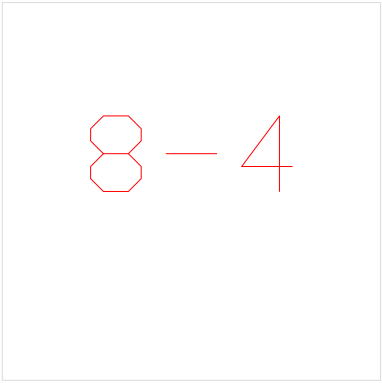
$$8 - 4$$

$$8 - 5$$



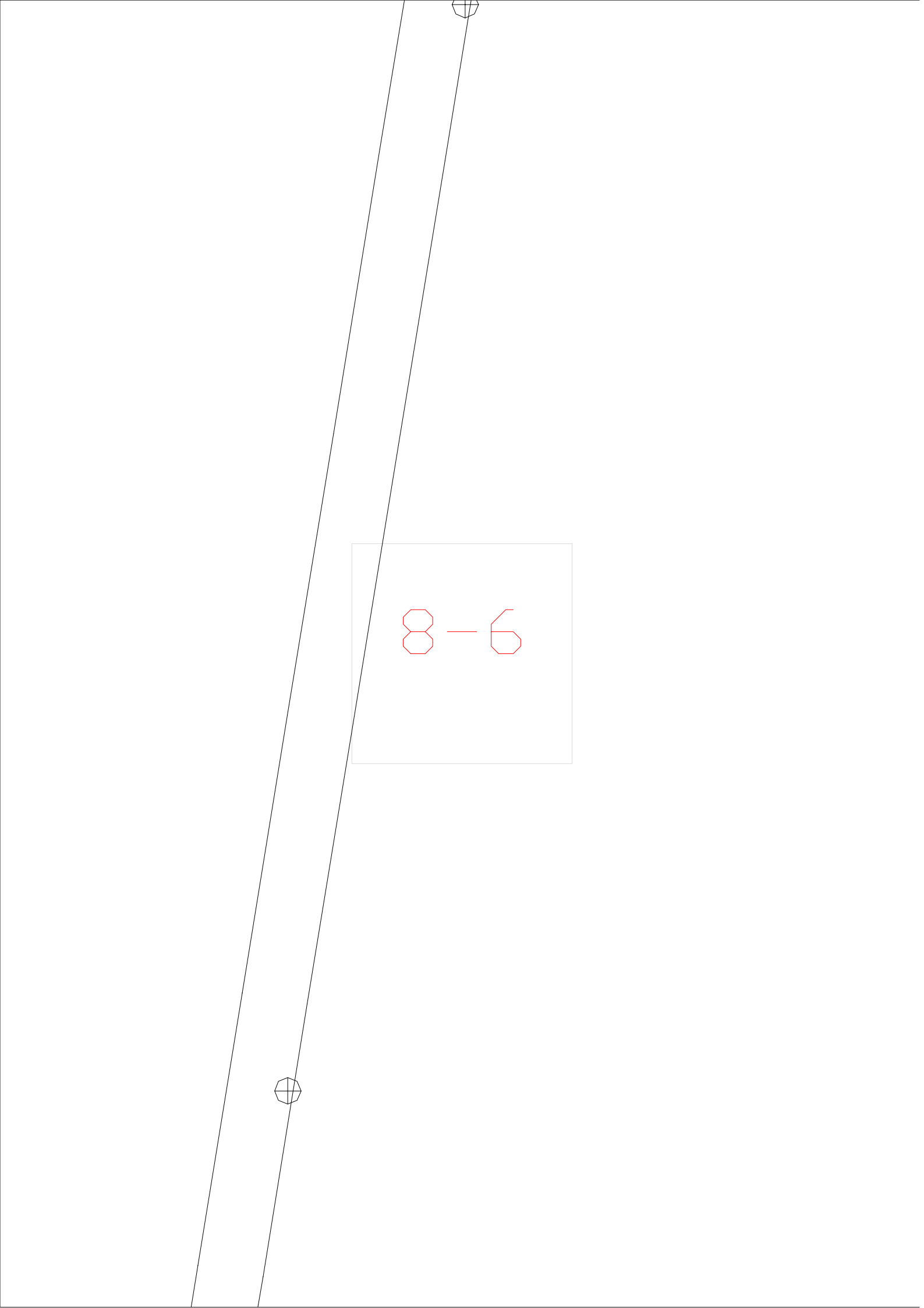

8-6

$$8 - 7$$



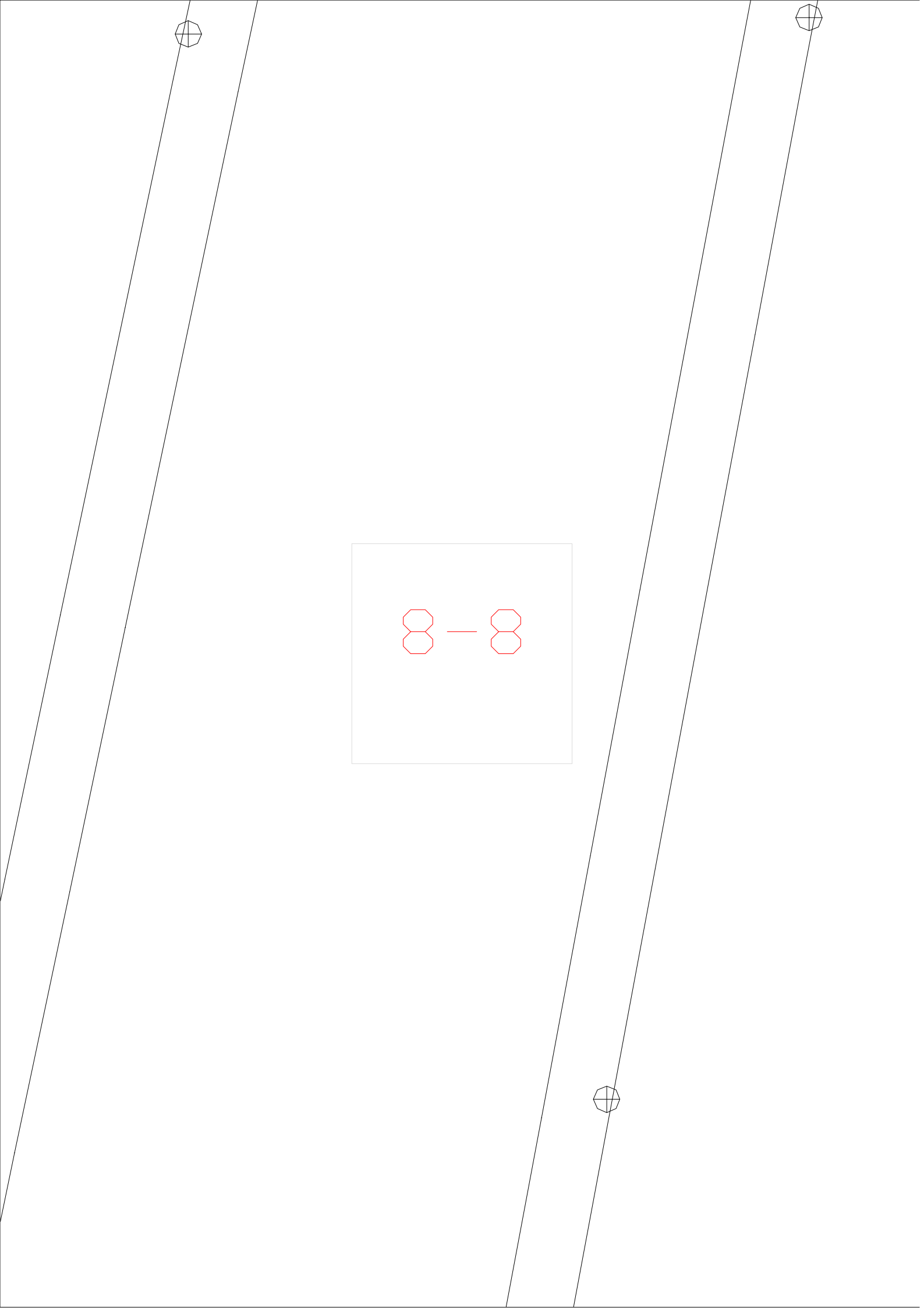

8-8

8-9



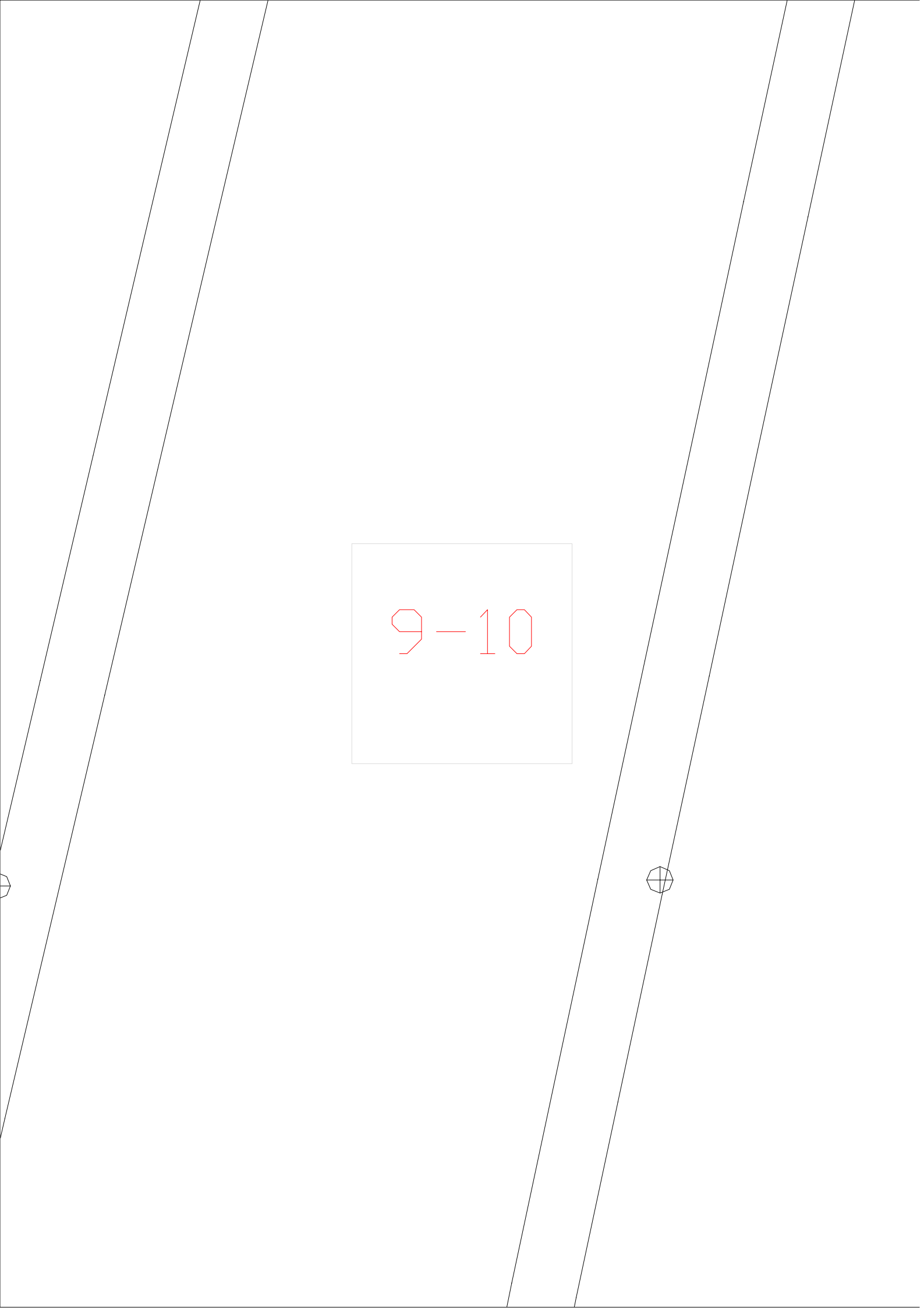

9-10

The image shows a technical drawing of a V-shaped groove. The groove is formed by two parallel lines that meet at a point at the bottom. The lines are drawn in black. In the center of the V, there is a light gray rectangular box containing the text '9-10' in red. On the left and right sides of the V, there are small circular symbols with a cross inside, likely representing fasteners or mounting points. The background is white.

9-11

9-12



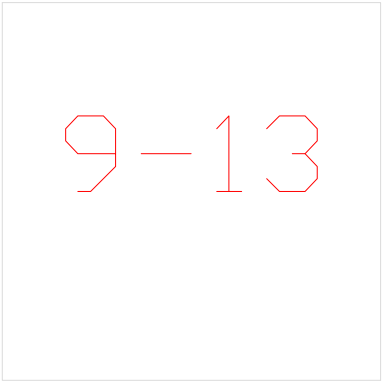

9-13

9-14



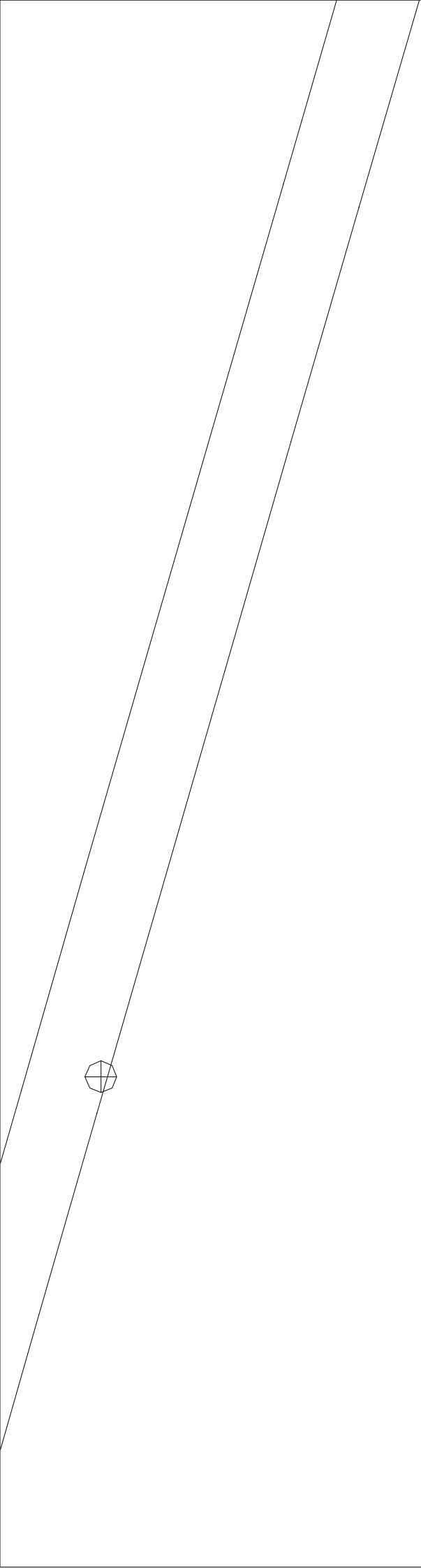

9-15

9-16





9-17



9-18



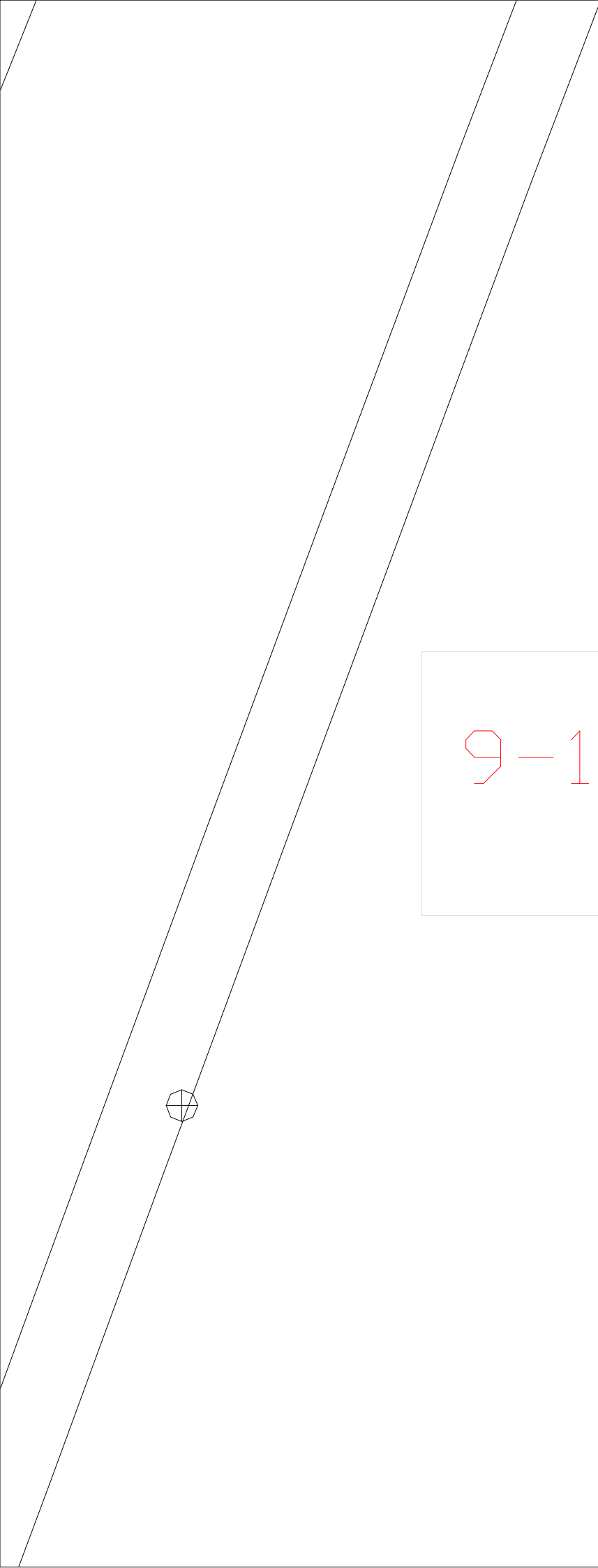

9-19

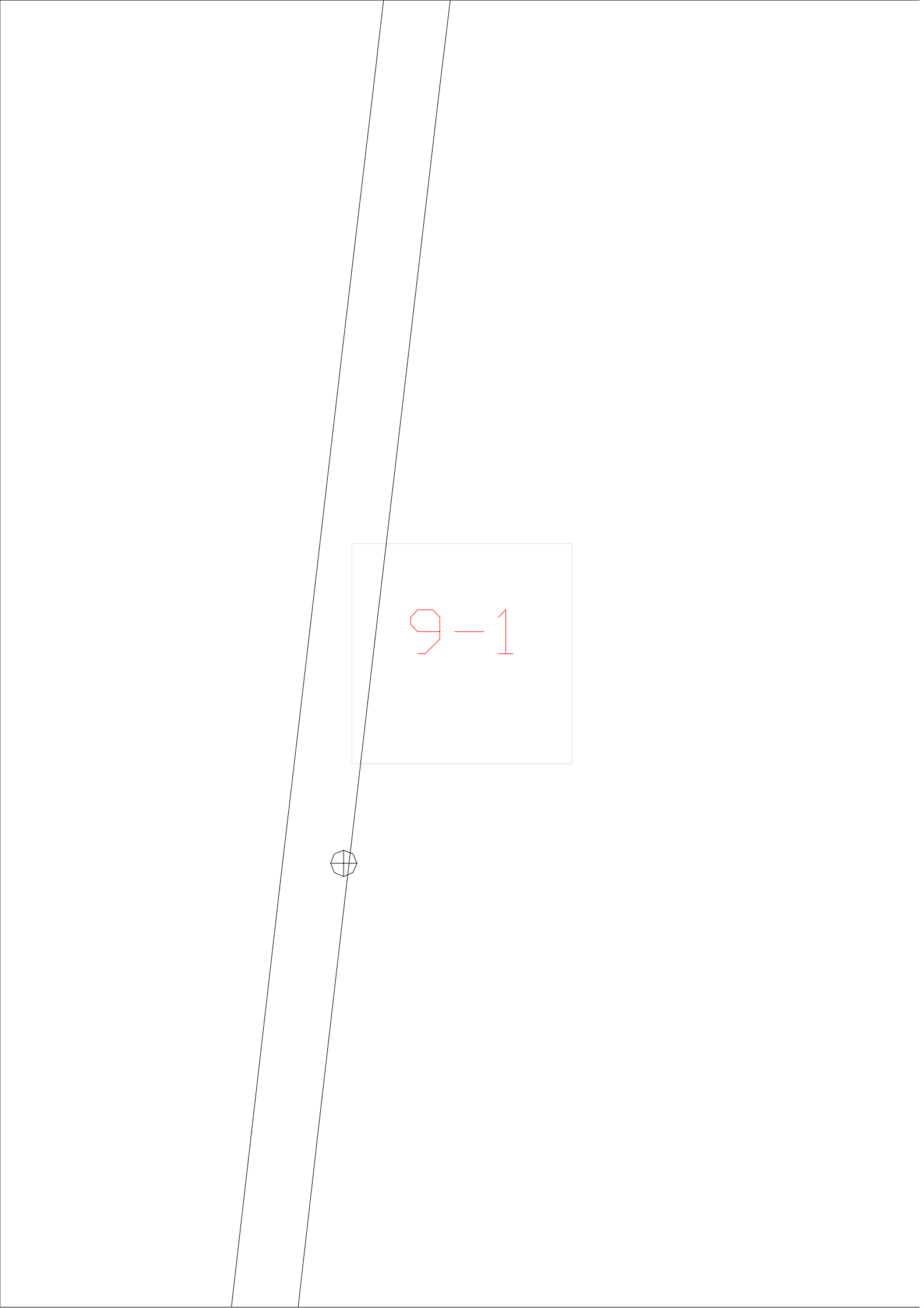

A technical drawing of a tapered shaft. The shaft is represented by two parallel lines that converge towards the top, indicating a taper. A circular hole is shown on the shaft, with a cross-section symbol consisting of a circle with a cross inside. A rectangular box is drawn around the shaft, containing the text "9-1" in red.

9-1

9-20



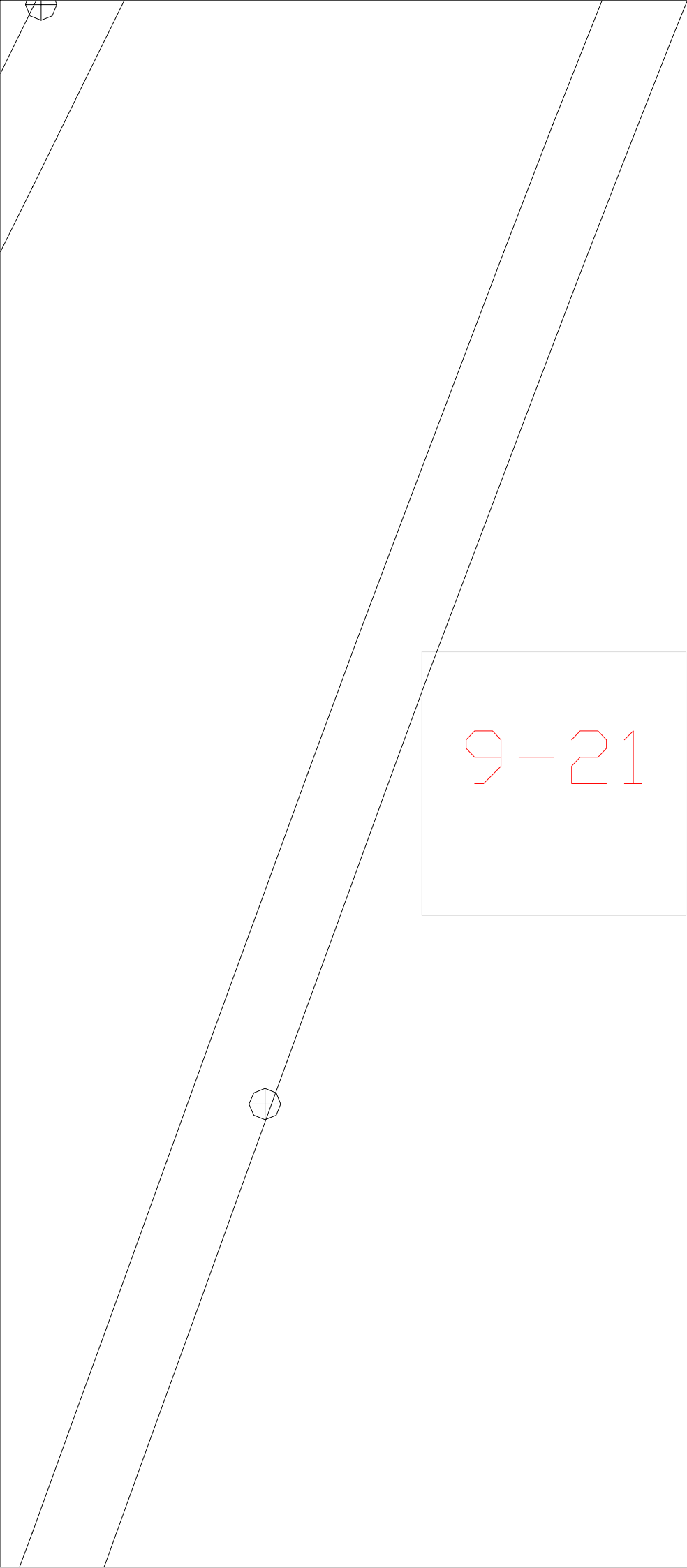

9-21

9-22



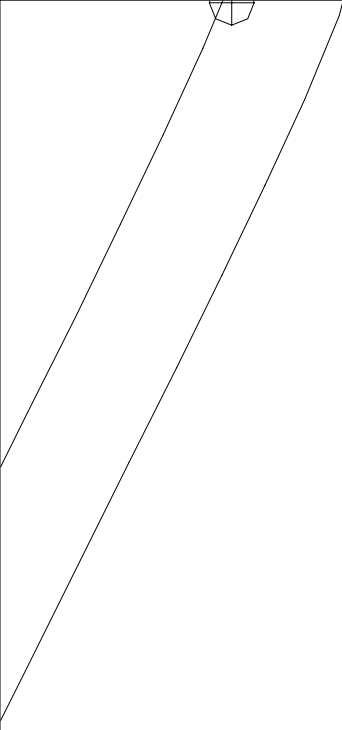

9-23

9-2

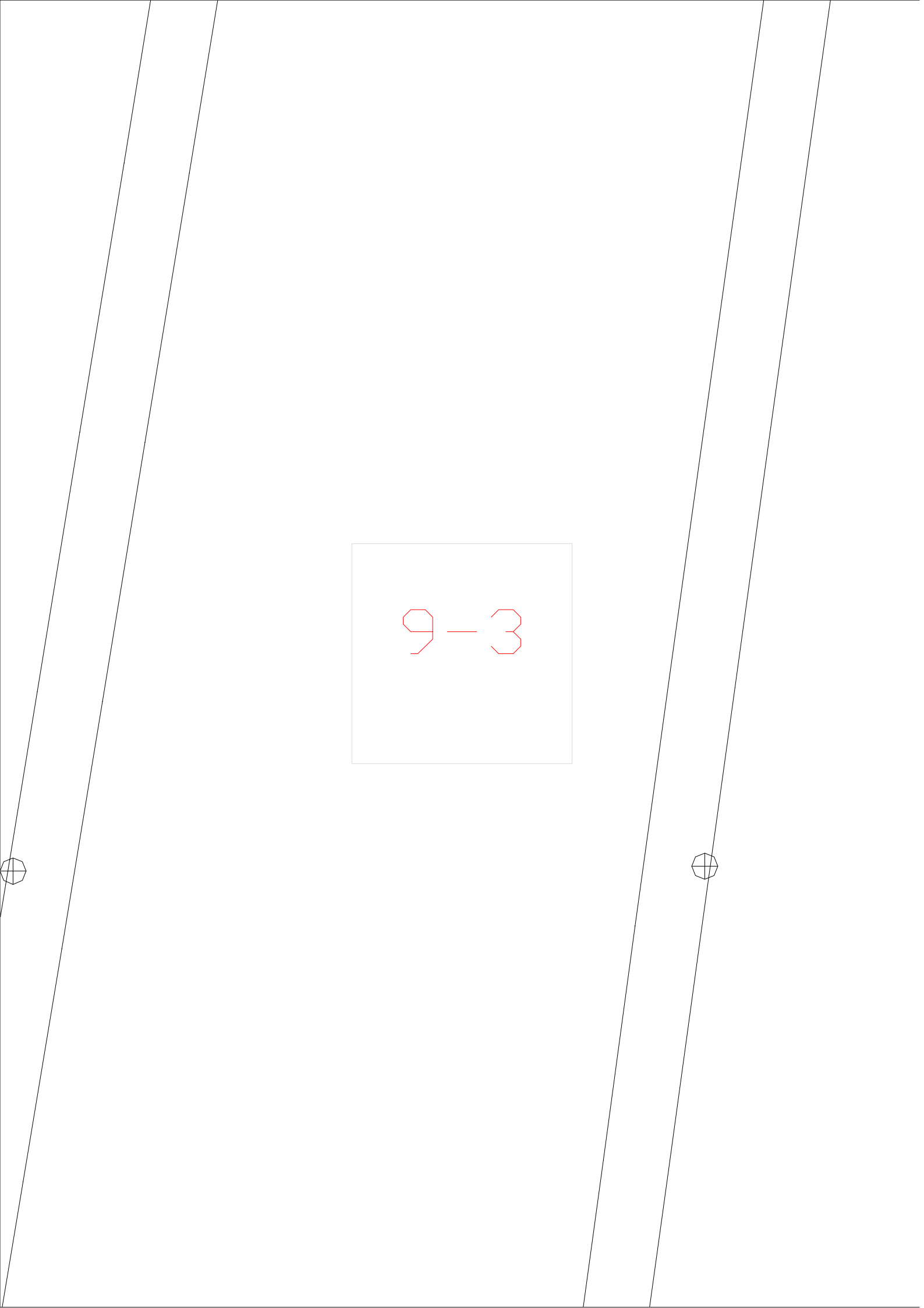

$$9 - 3$$

$$9 - 4$$

9-5





9-6

$$9 - 7$$



9 - 8



