

1-10

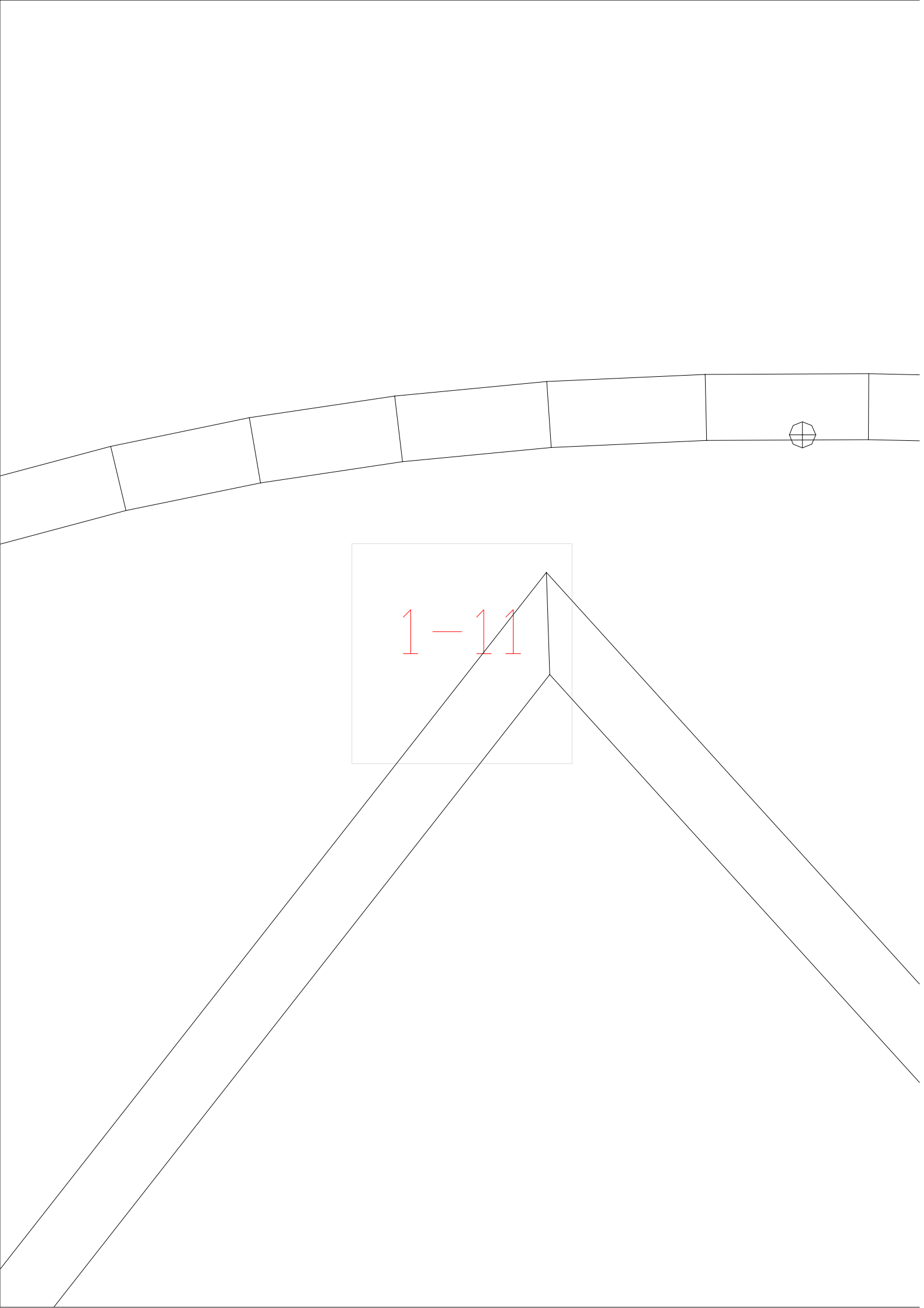

1-111

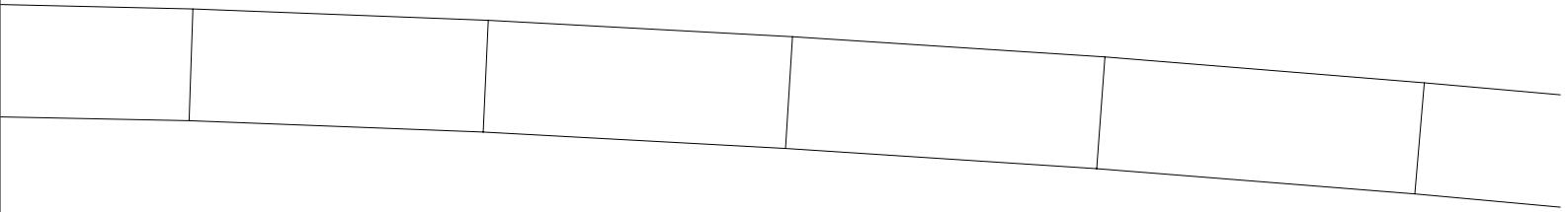

1-12

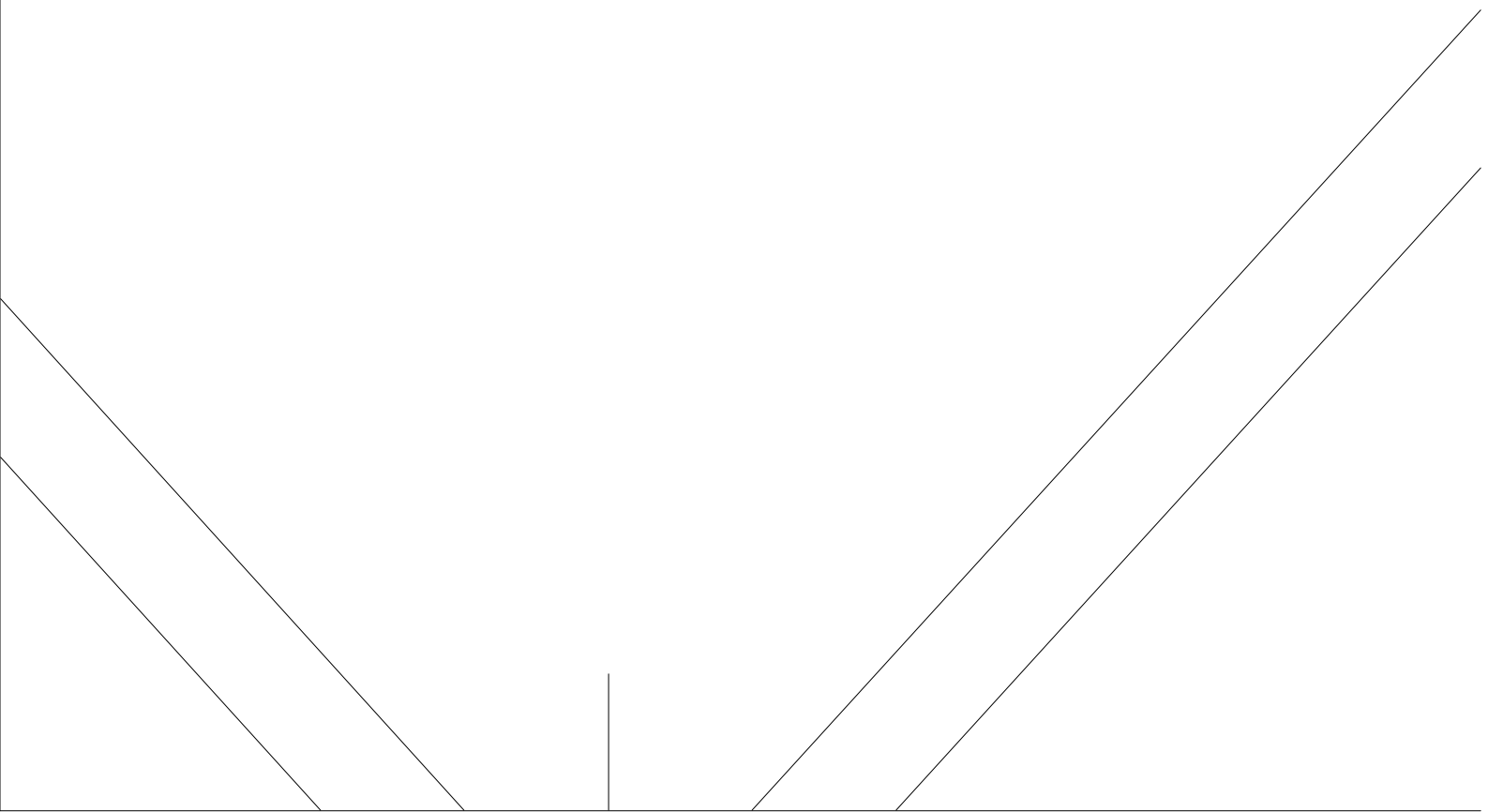

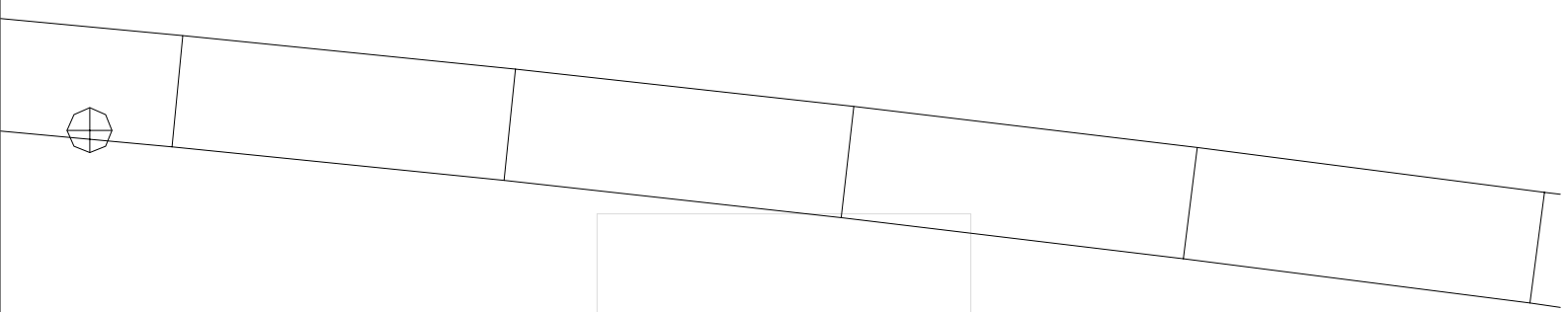

1-13

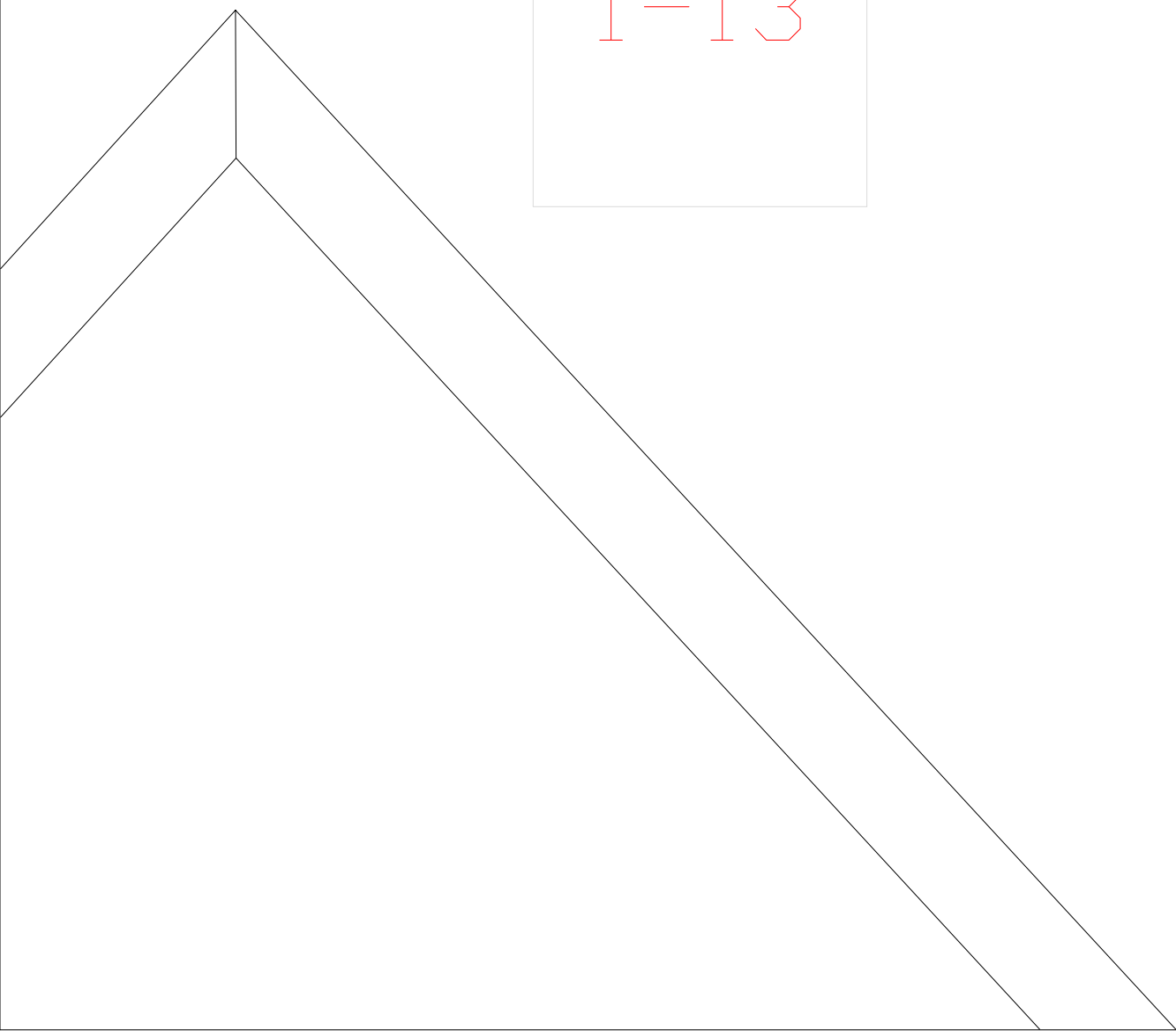

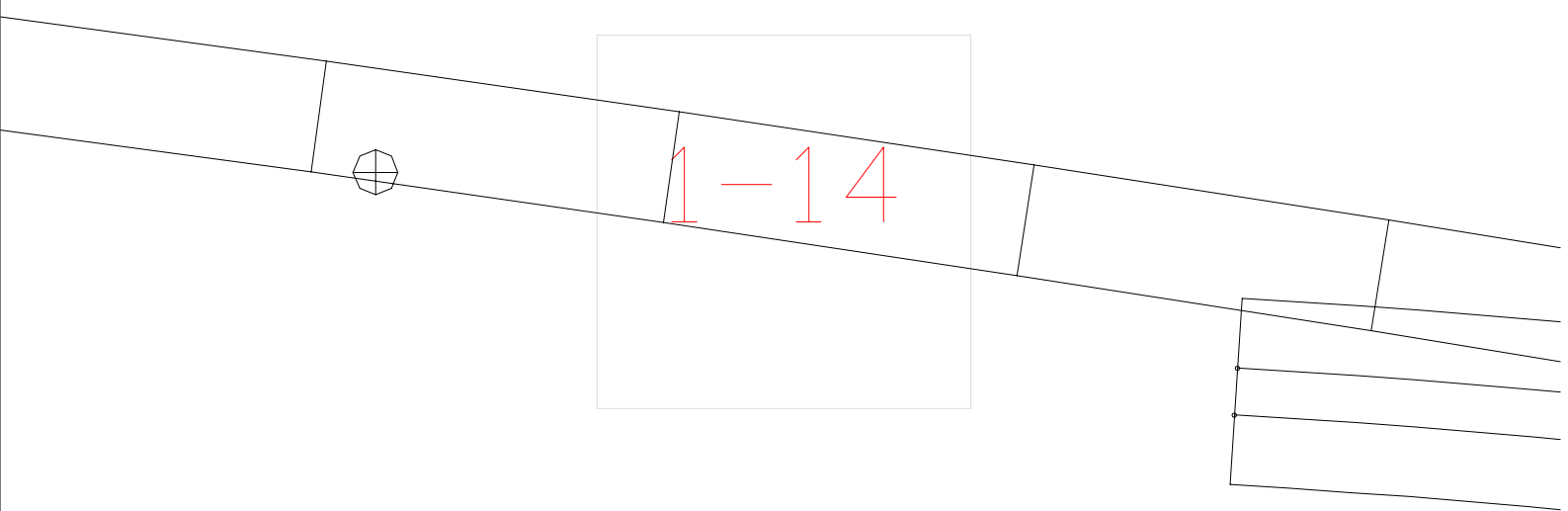

1-14

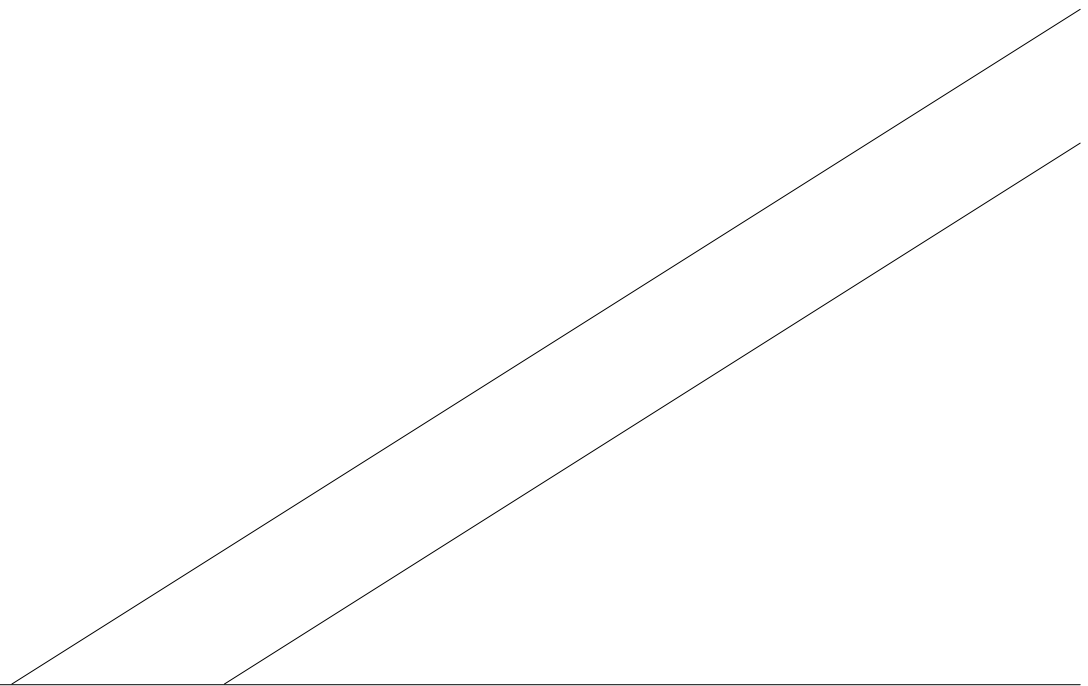
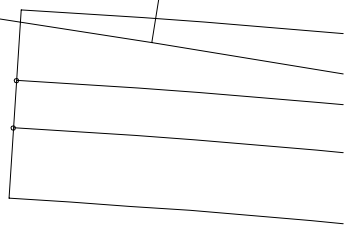

1-15



1-16

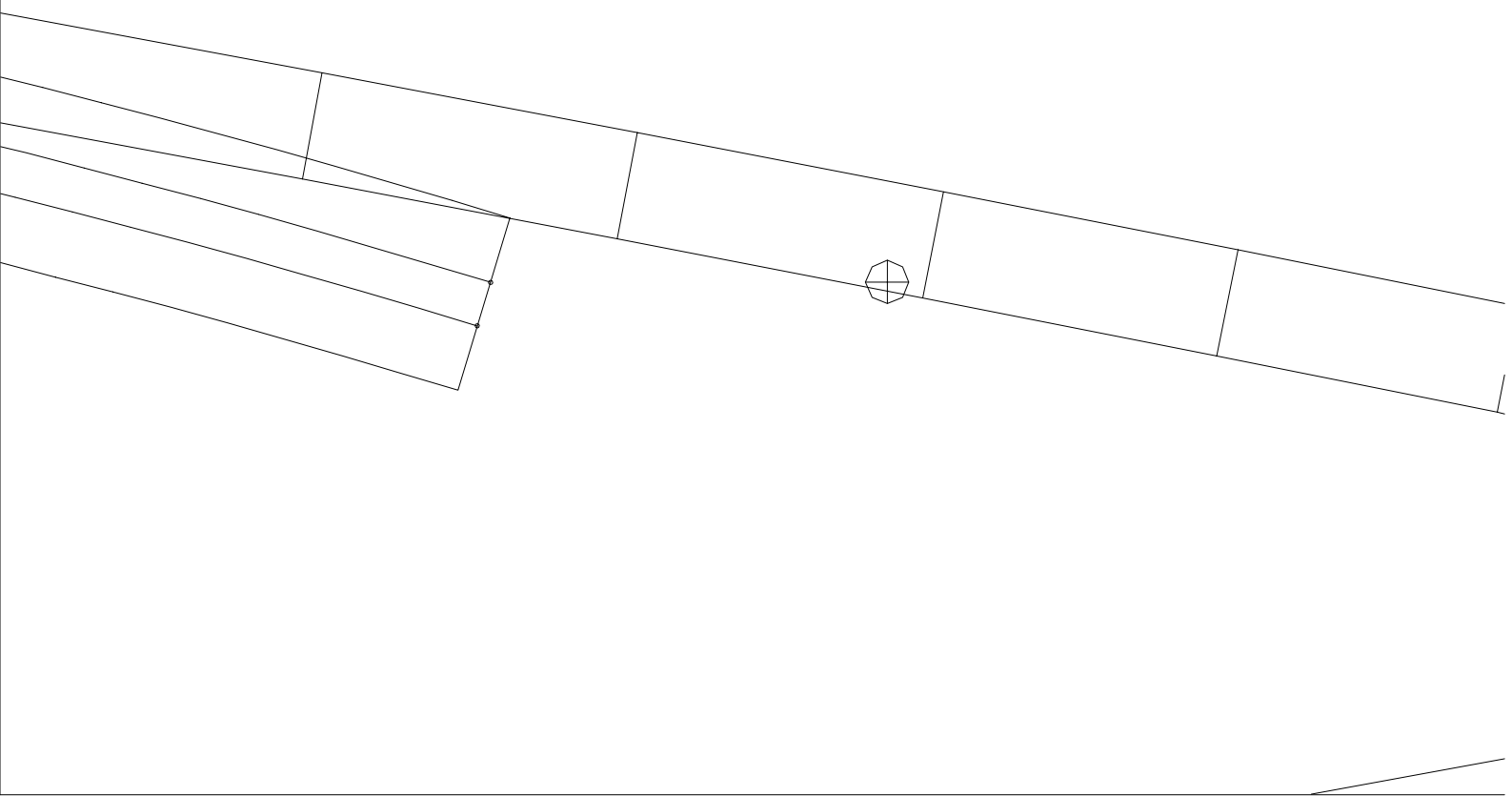

1-17

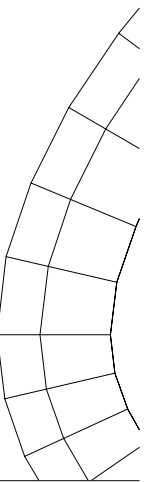
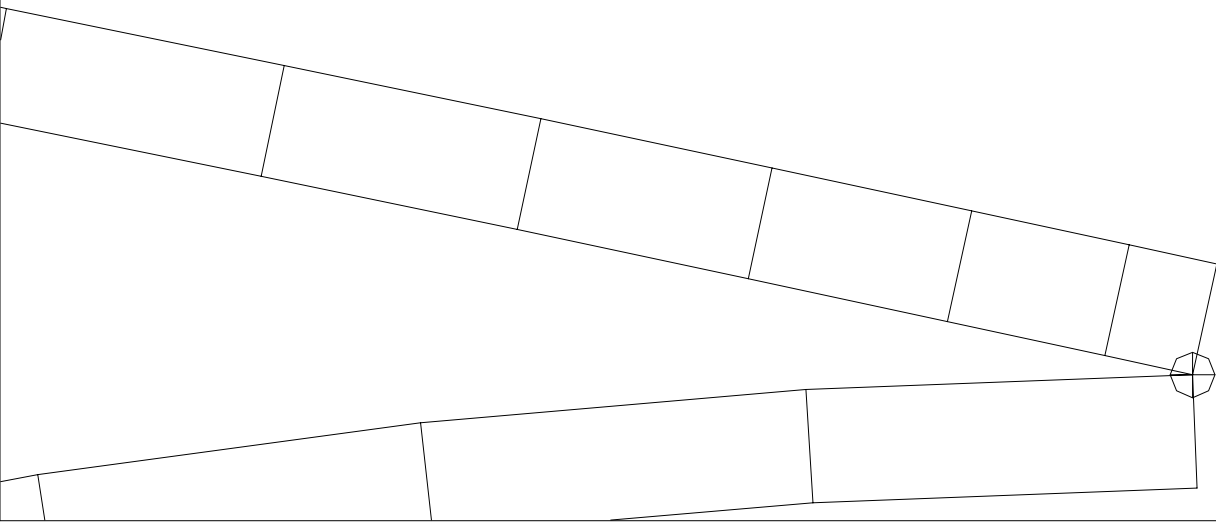

1-18

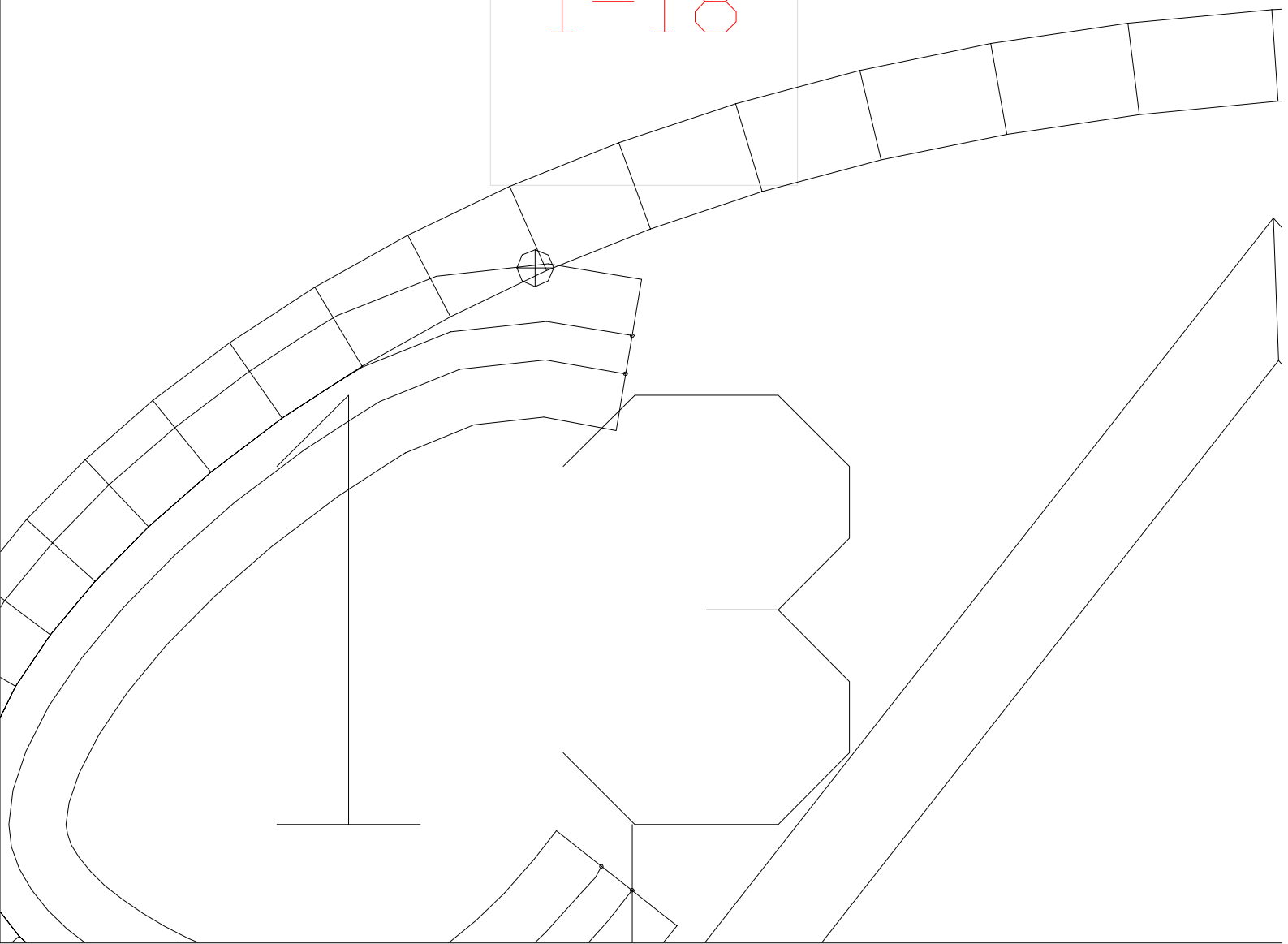

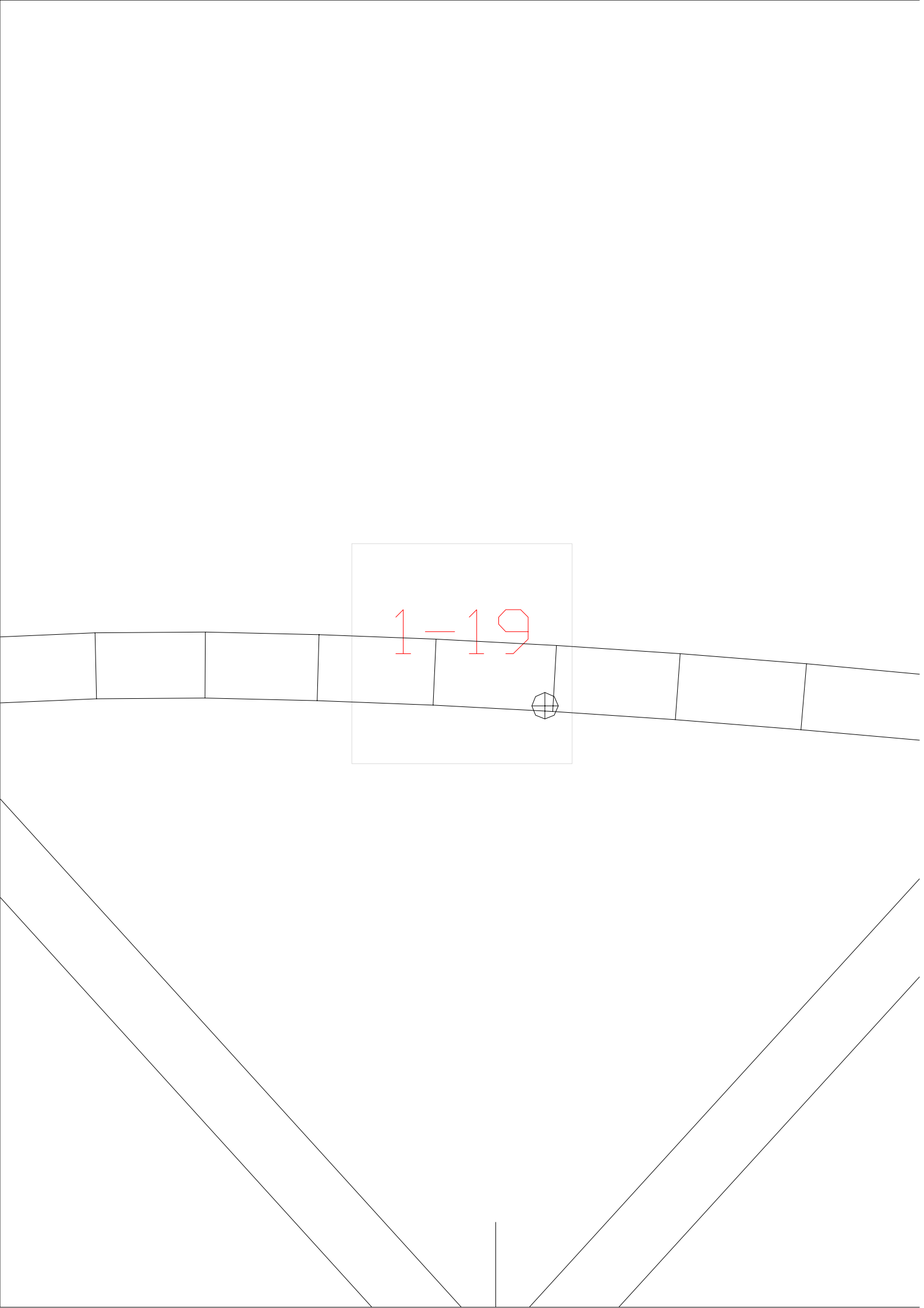

1-19

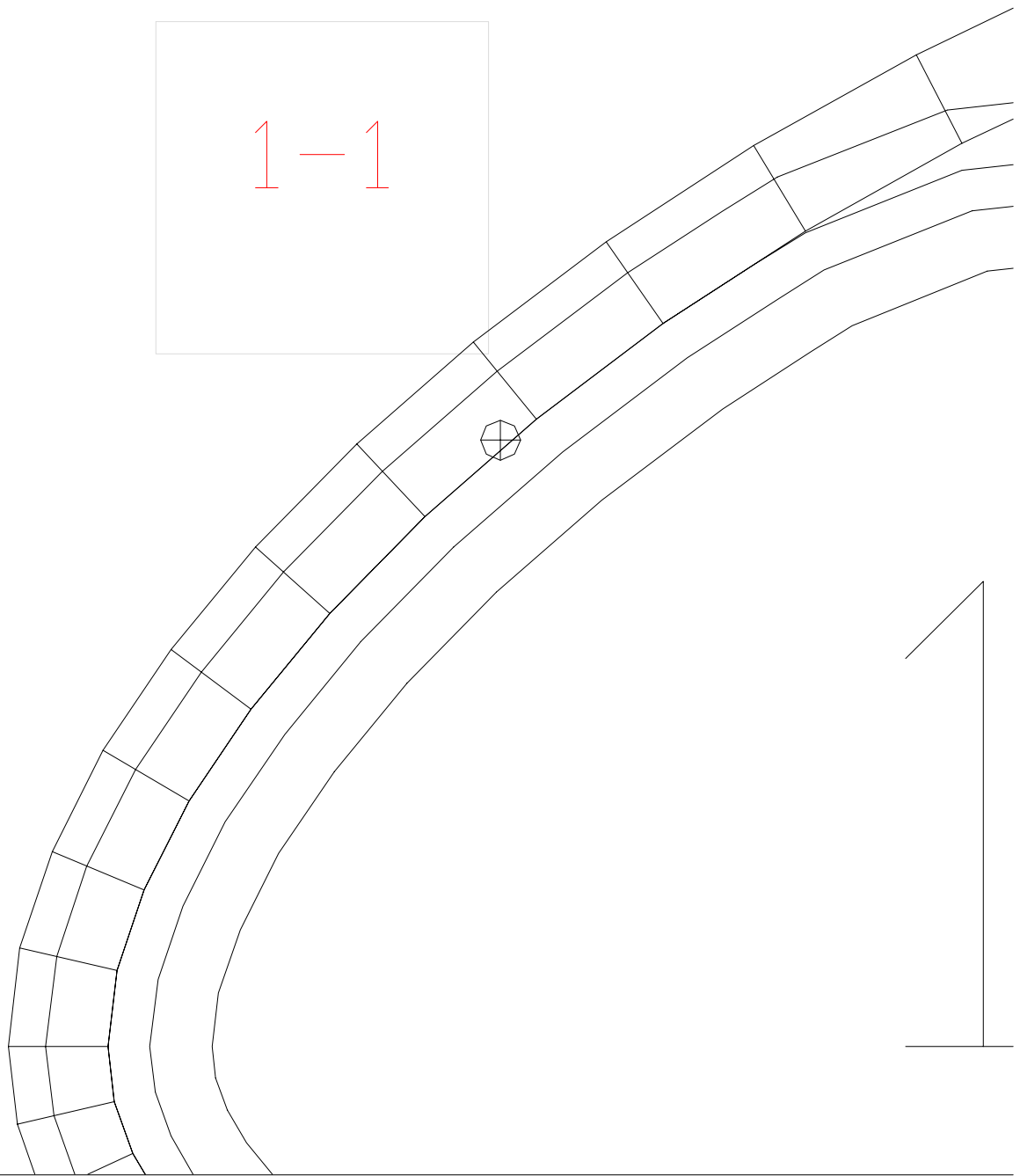

1-1

1-20

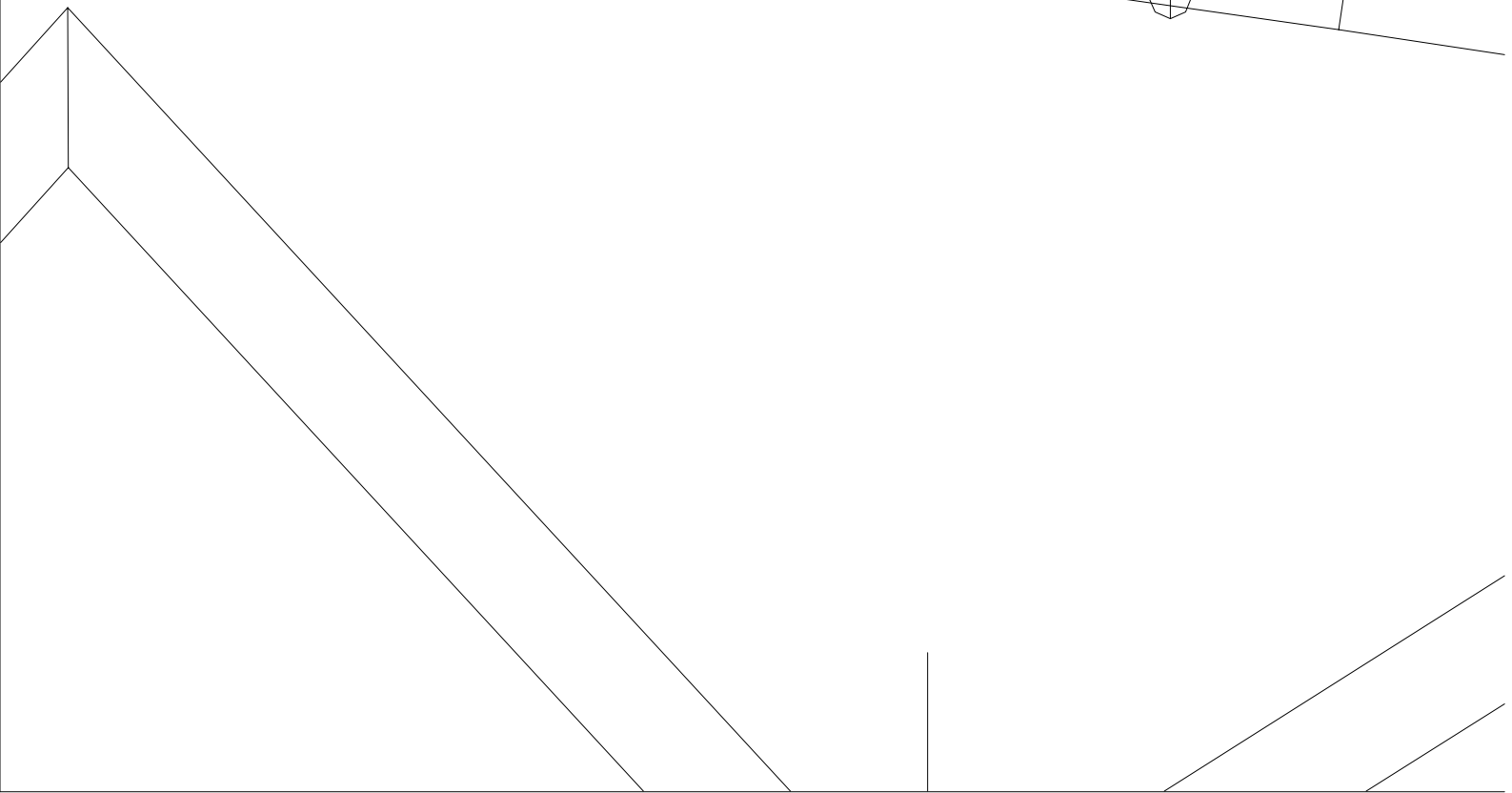
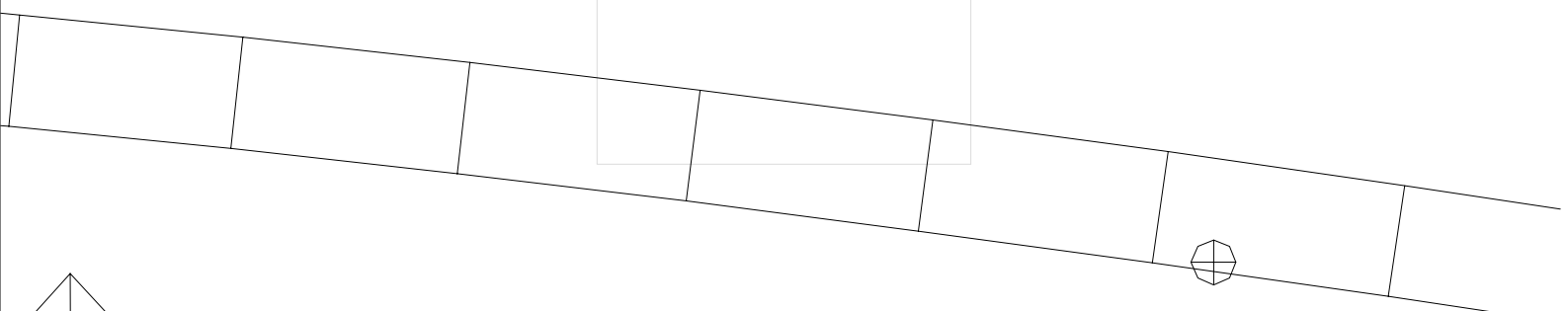

1-21

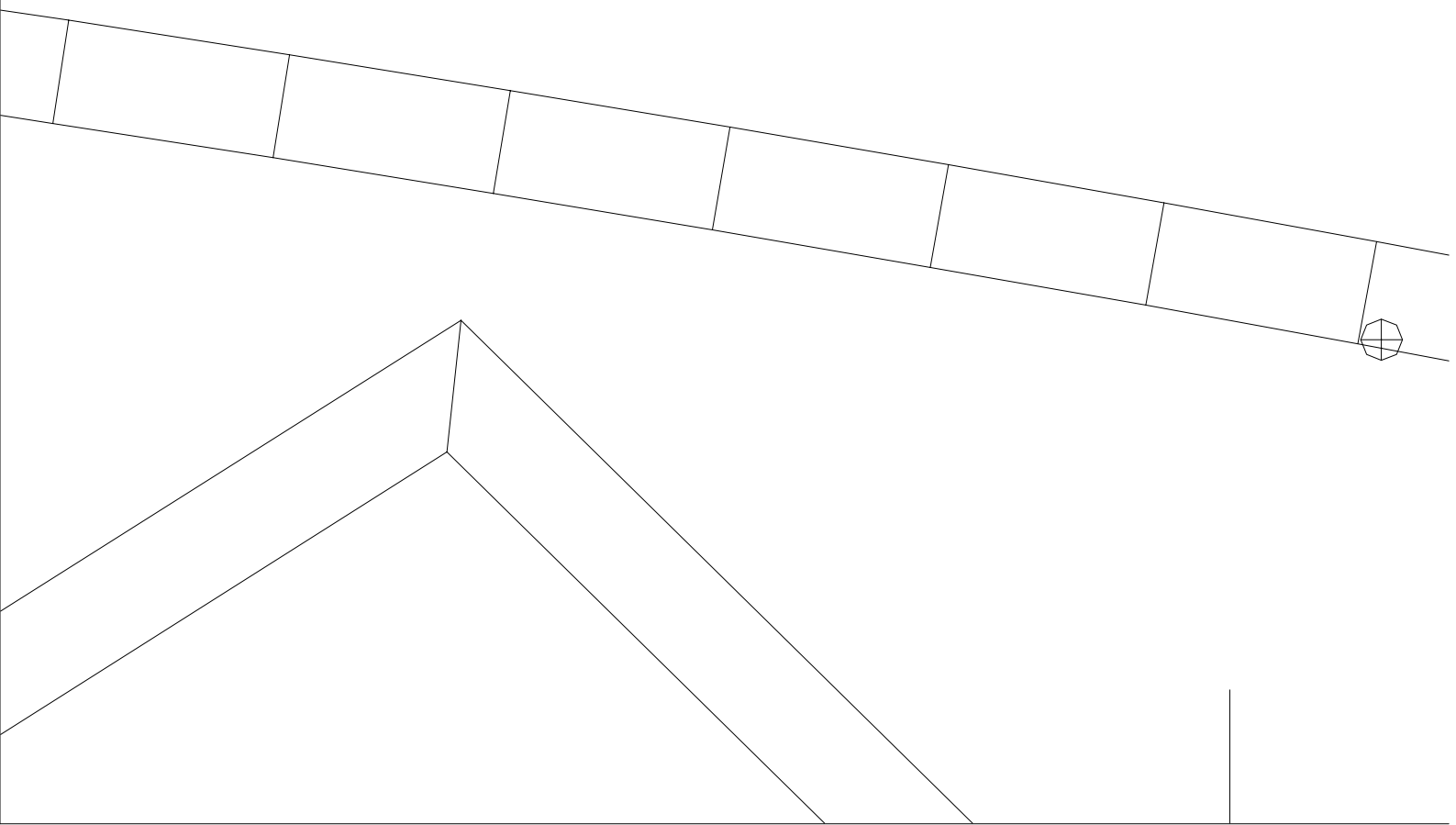

1-22

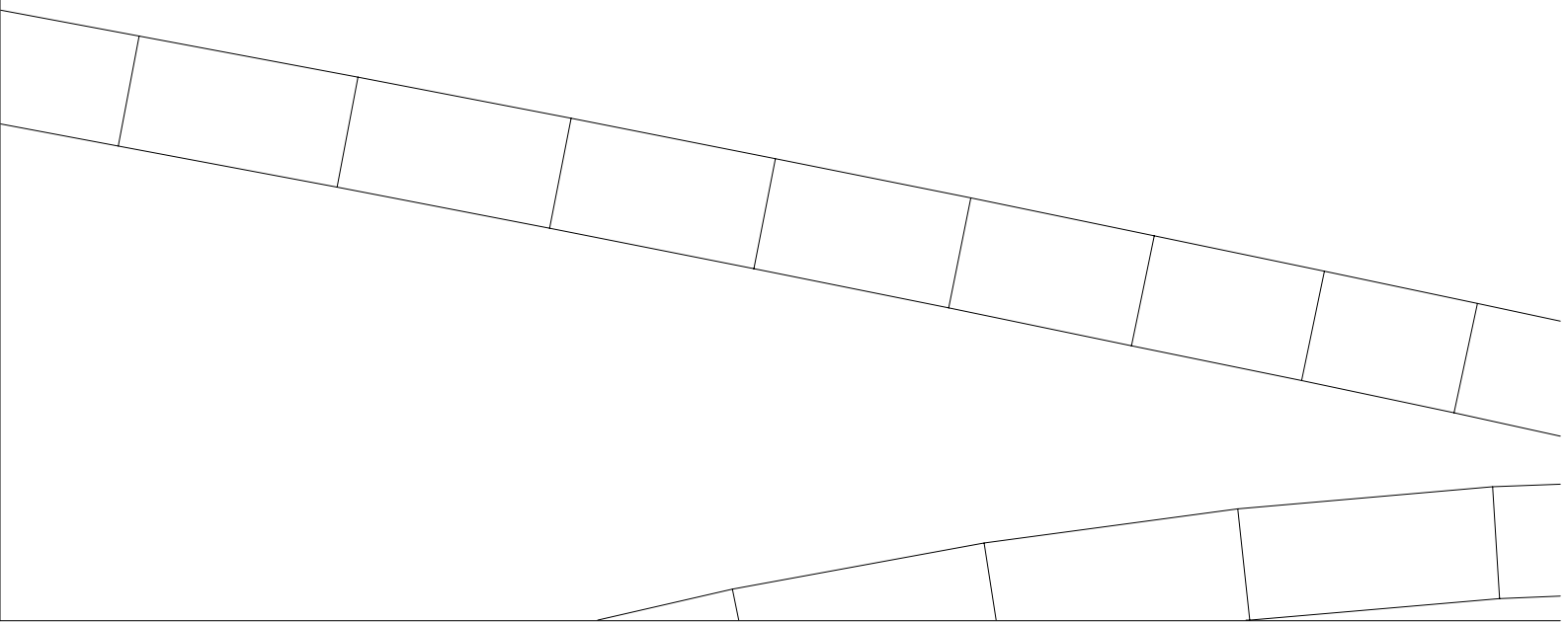

1-23

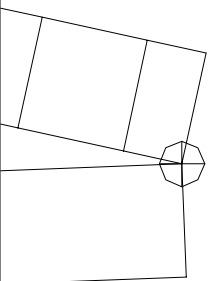

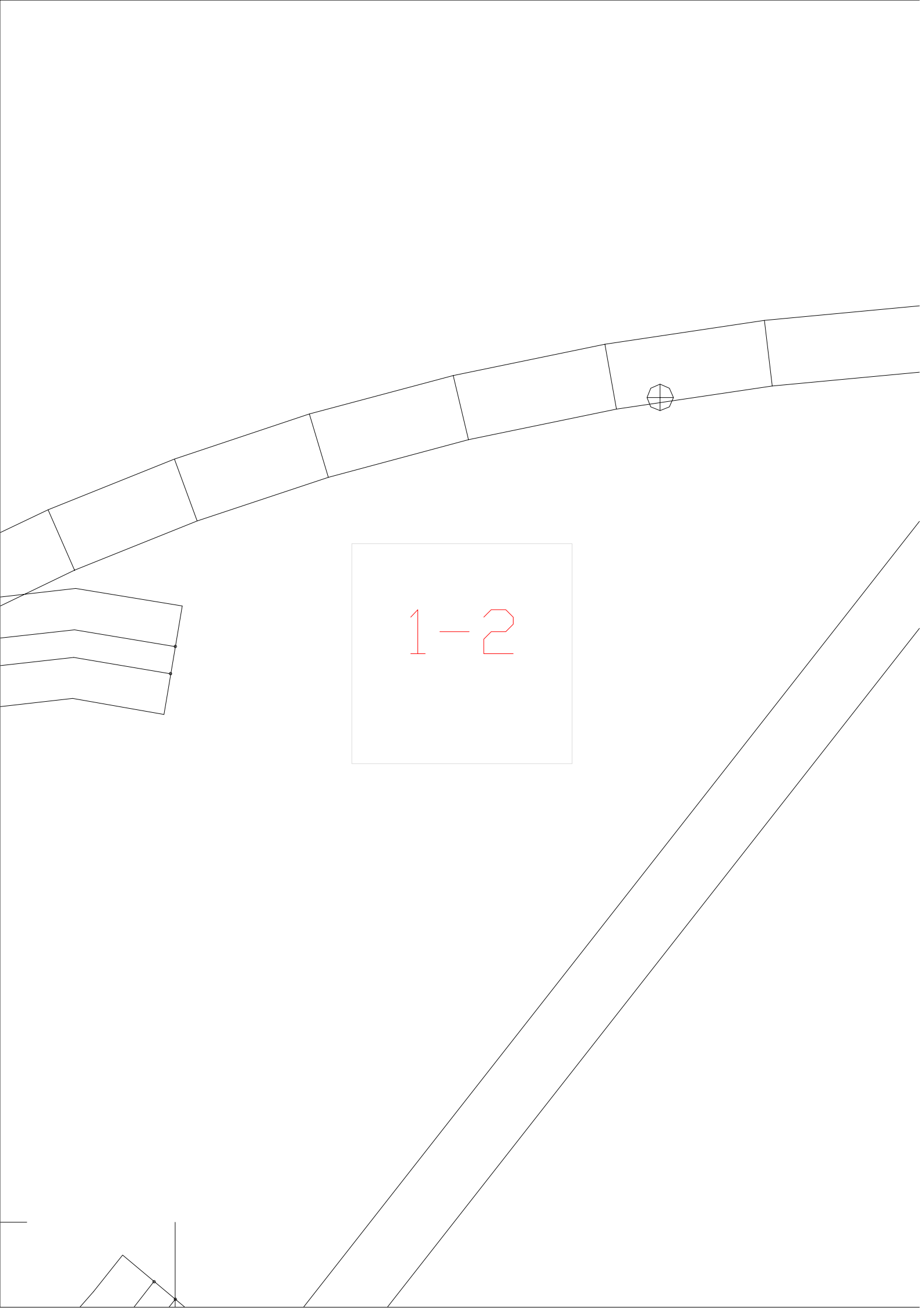

1-2



1-3

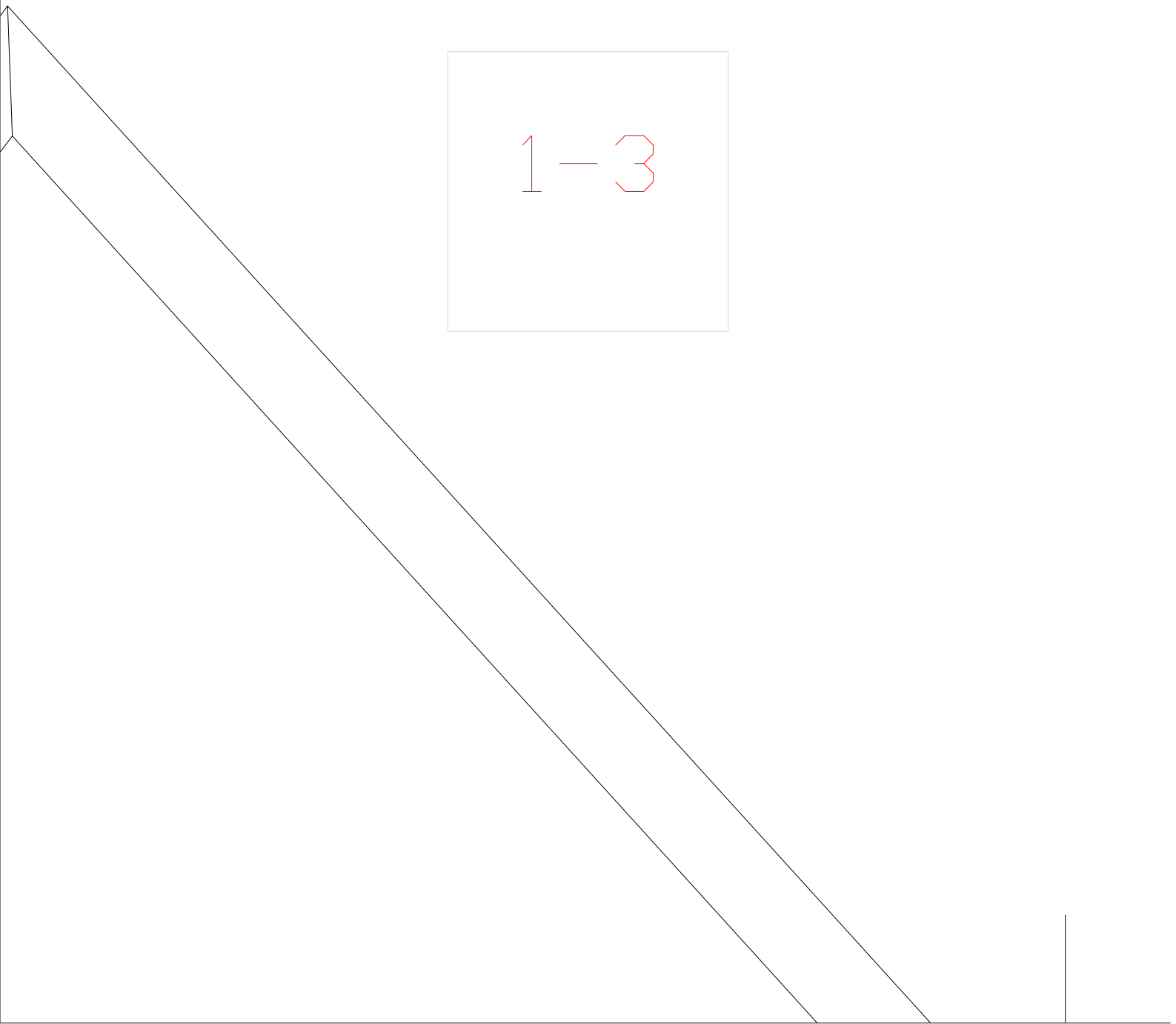

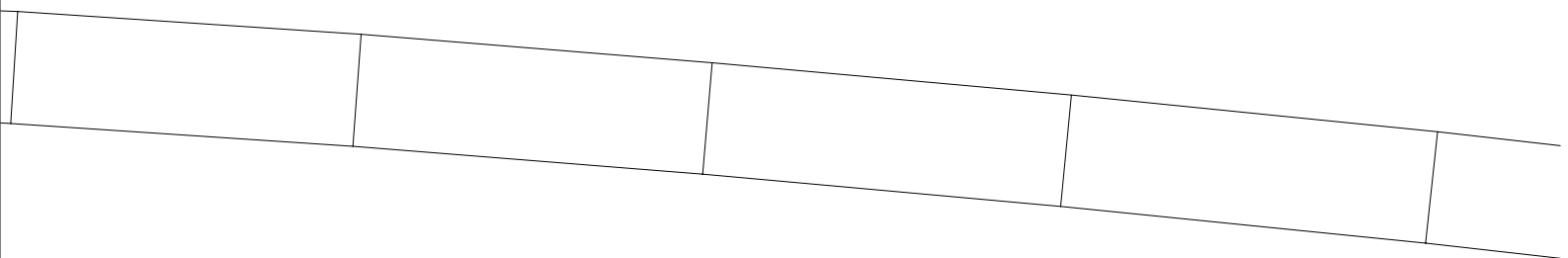

1-4

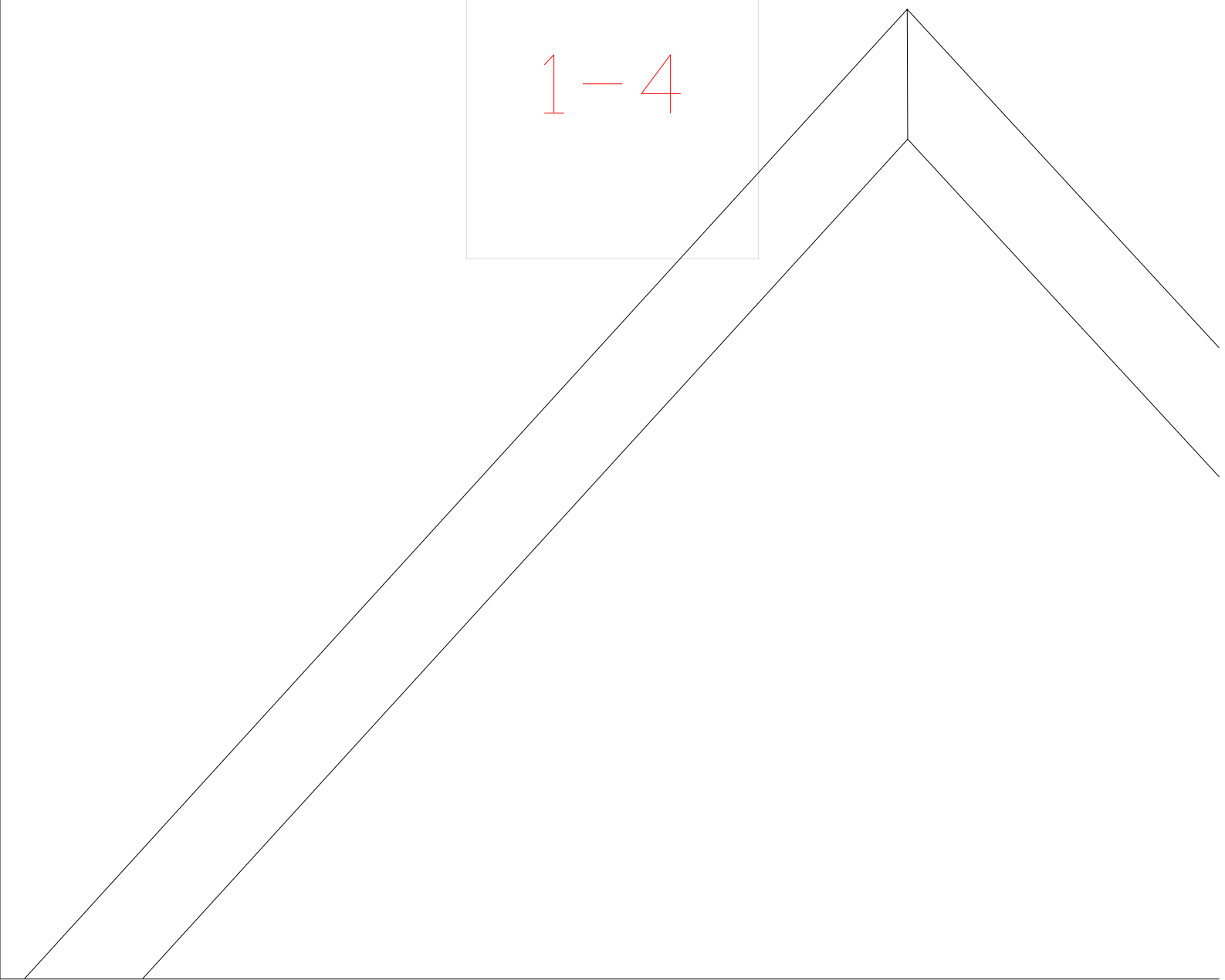

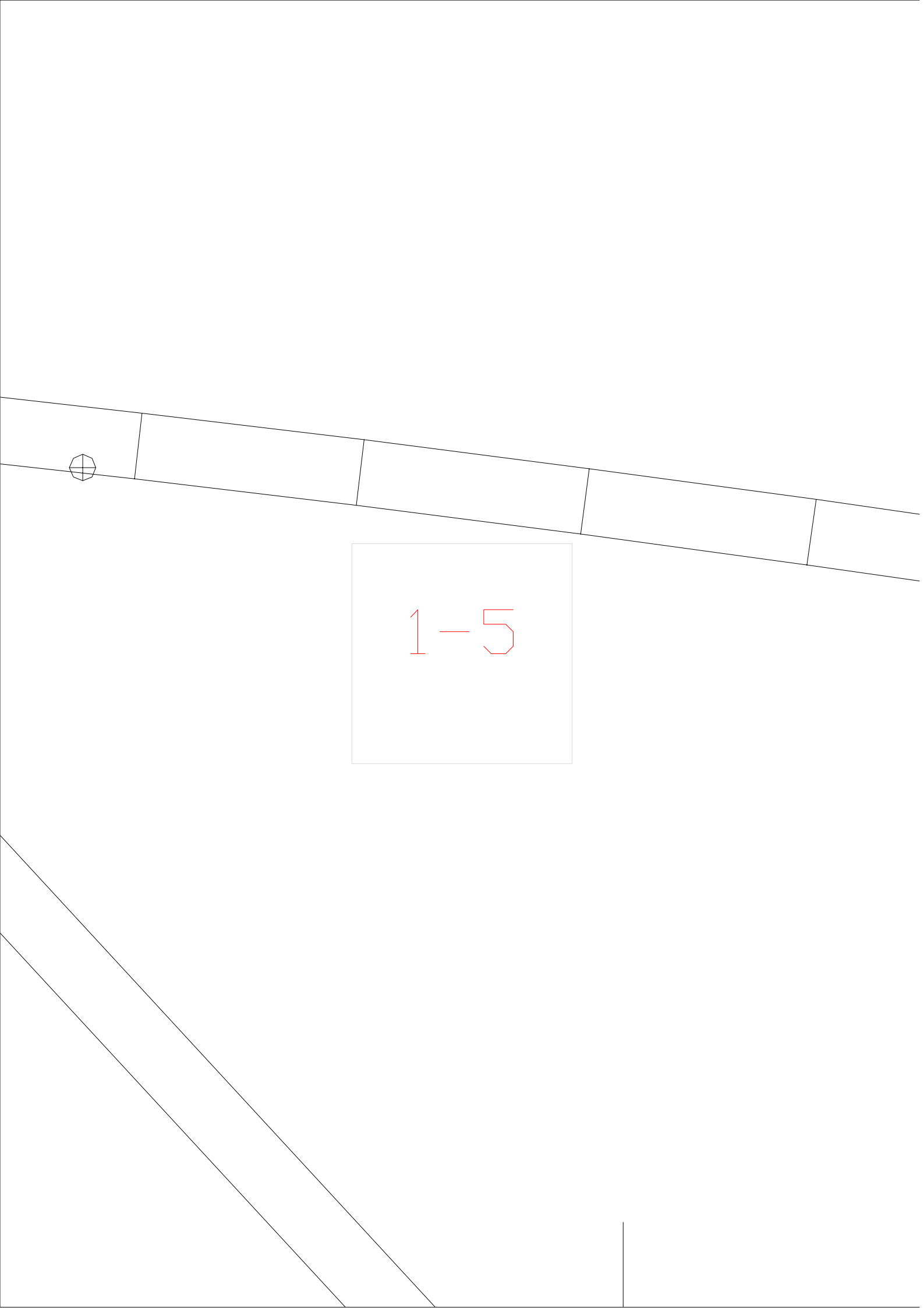

1-5

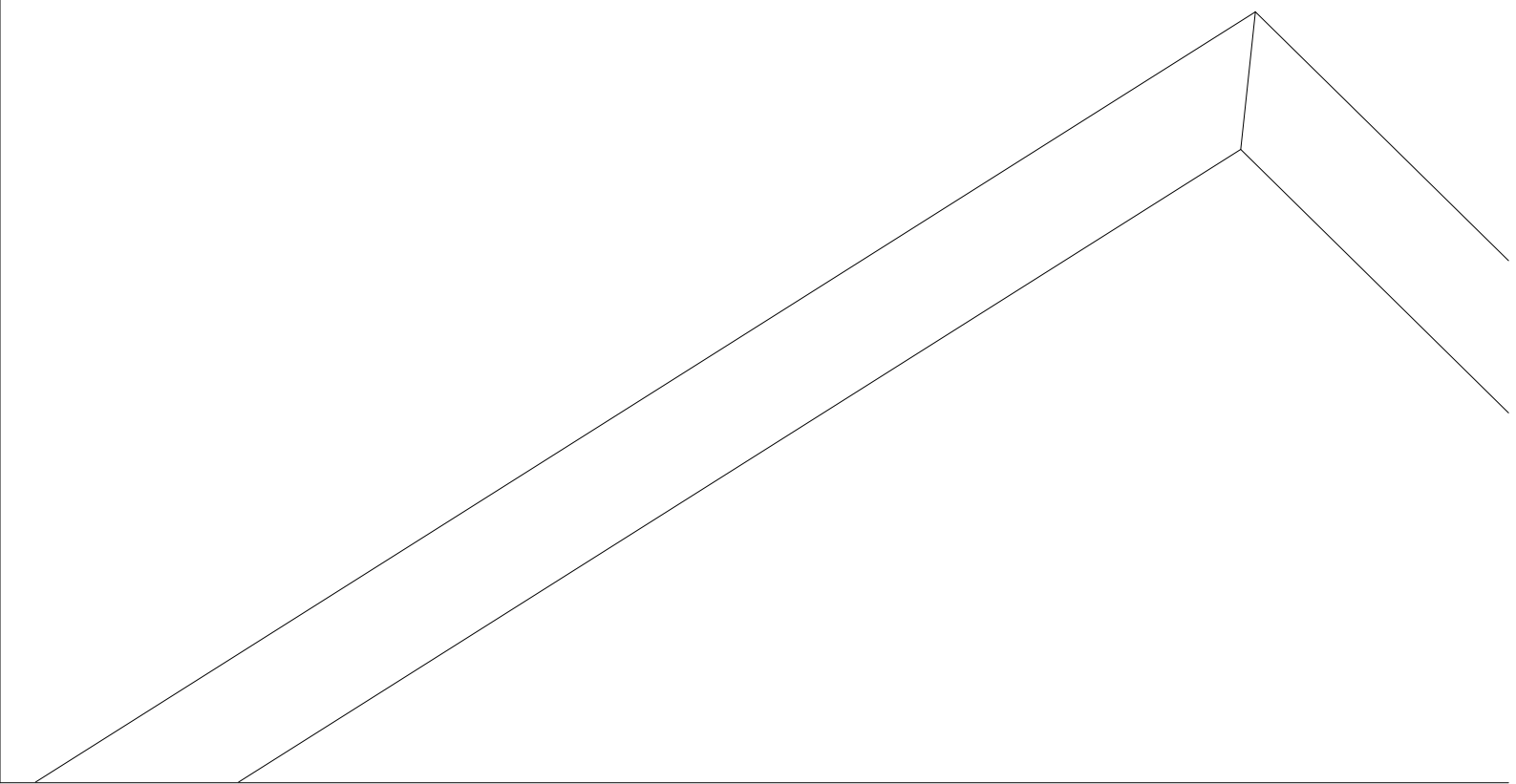
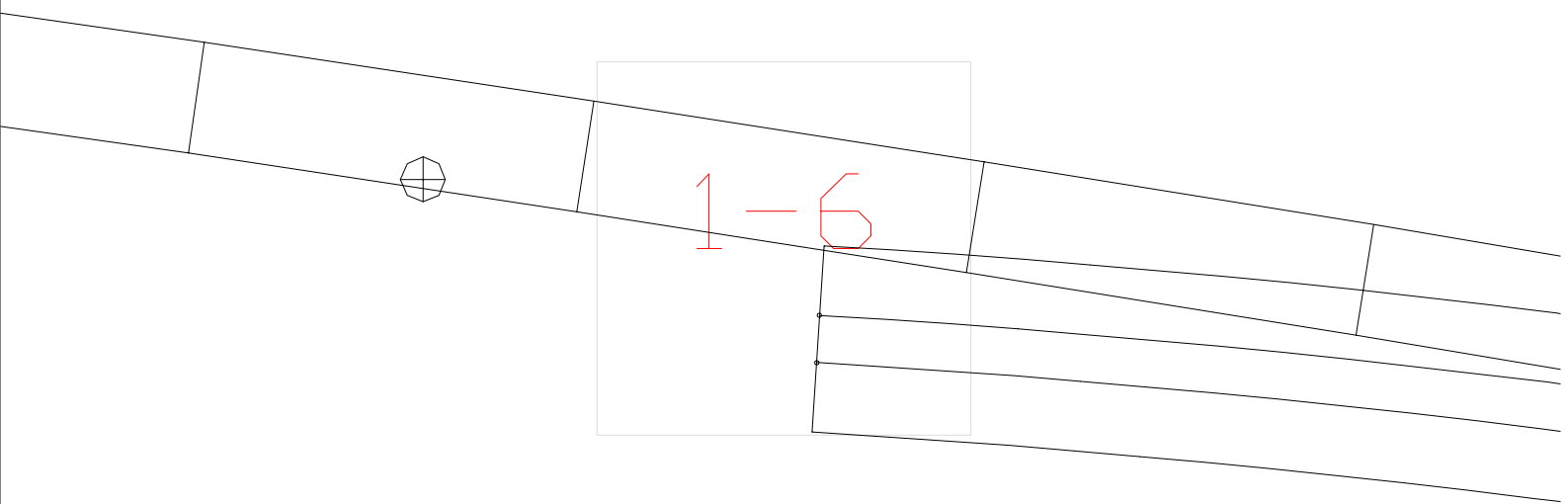

1-7



1-8

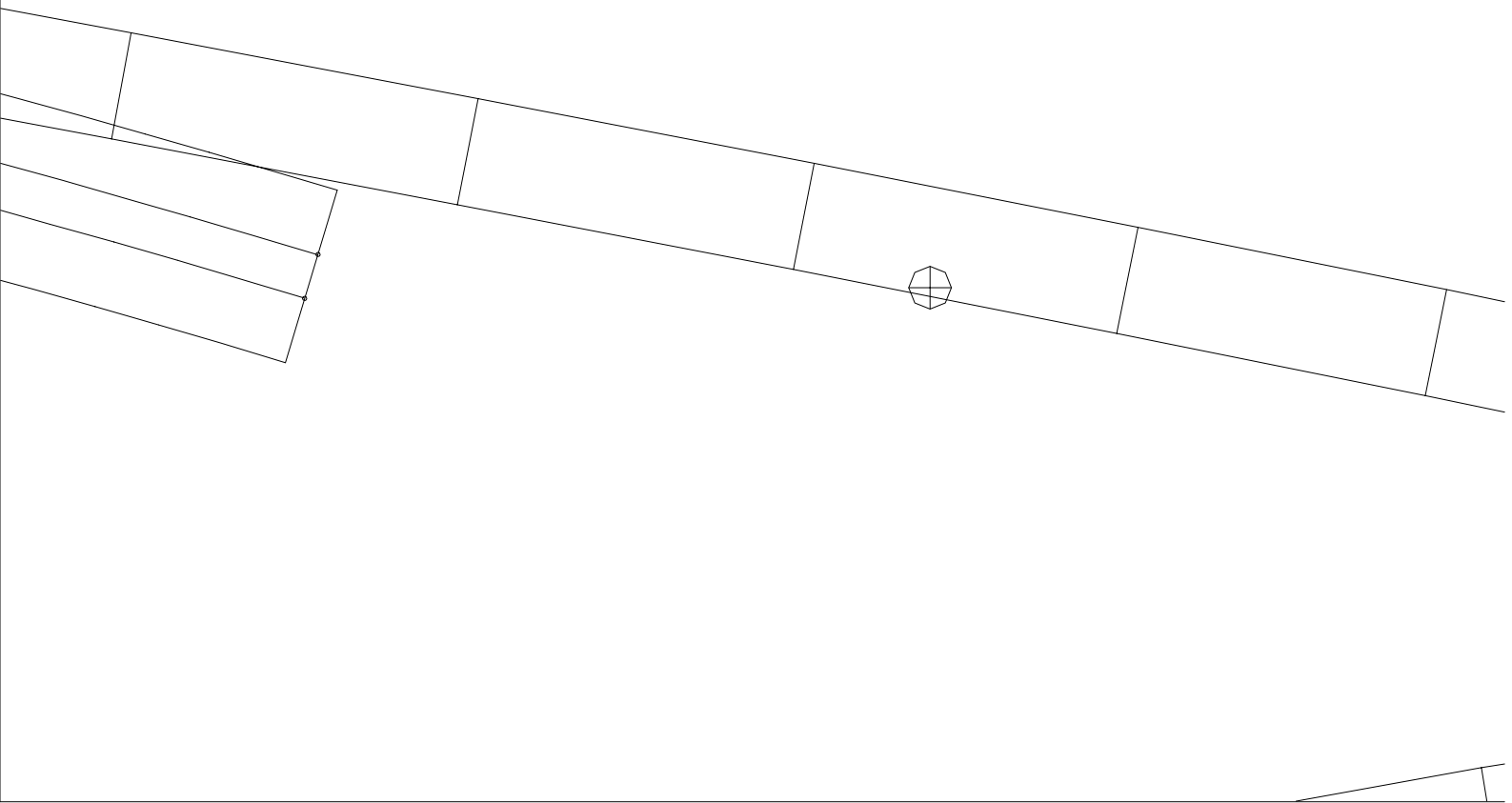

1-9

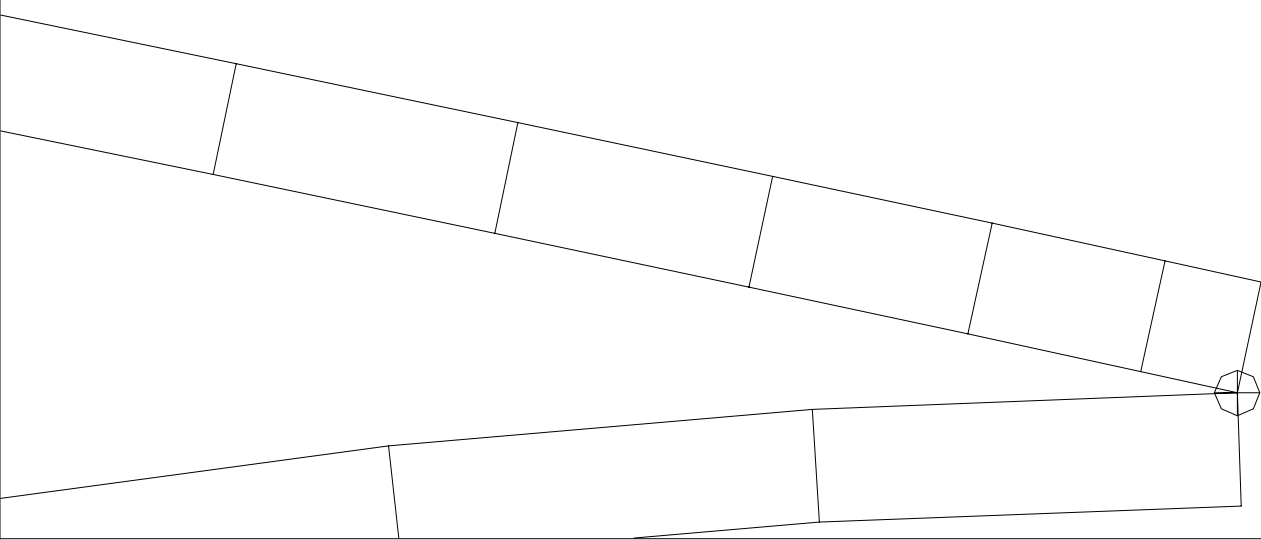

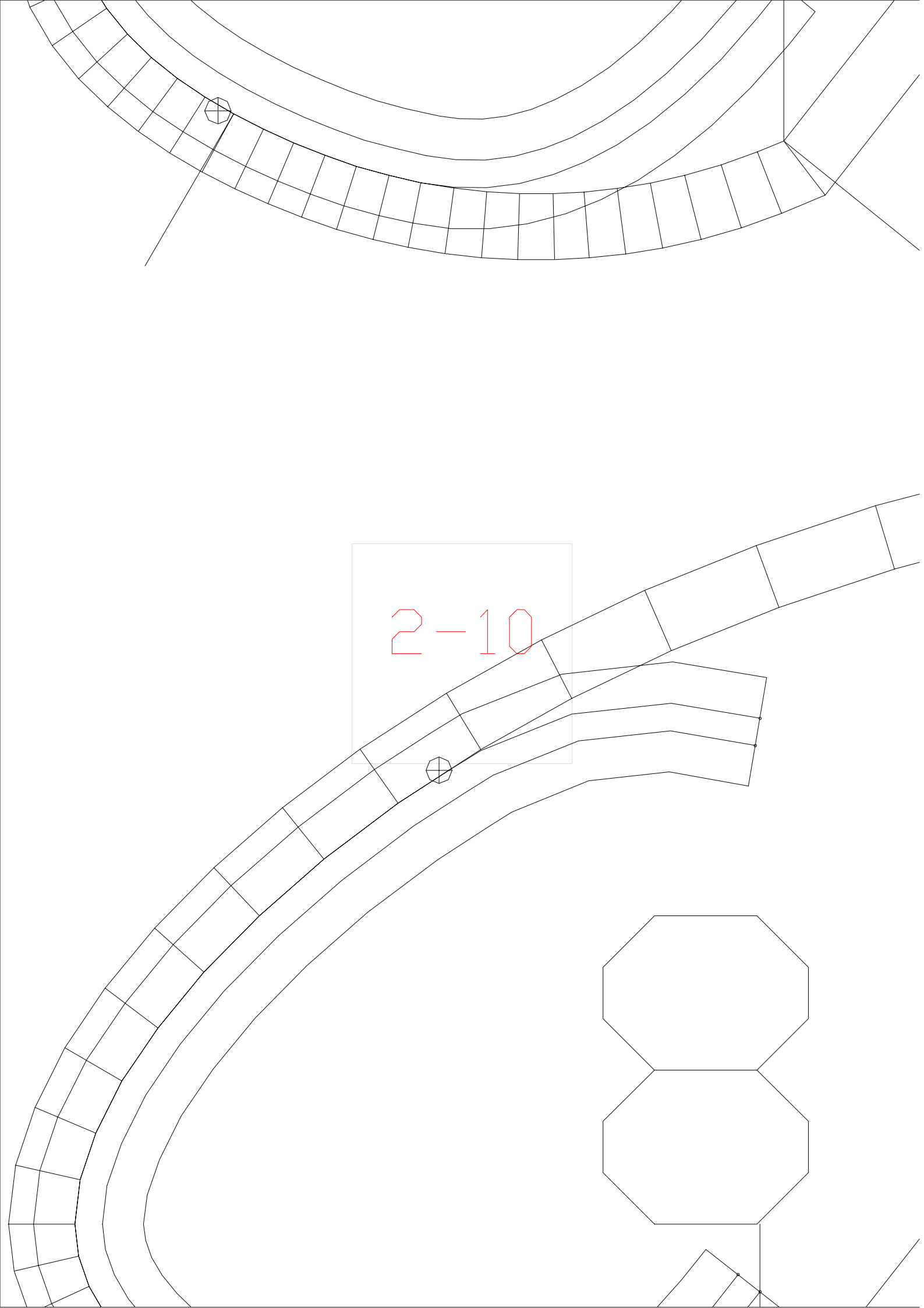

2-10

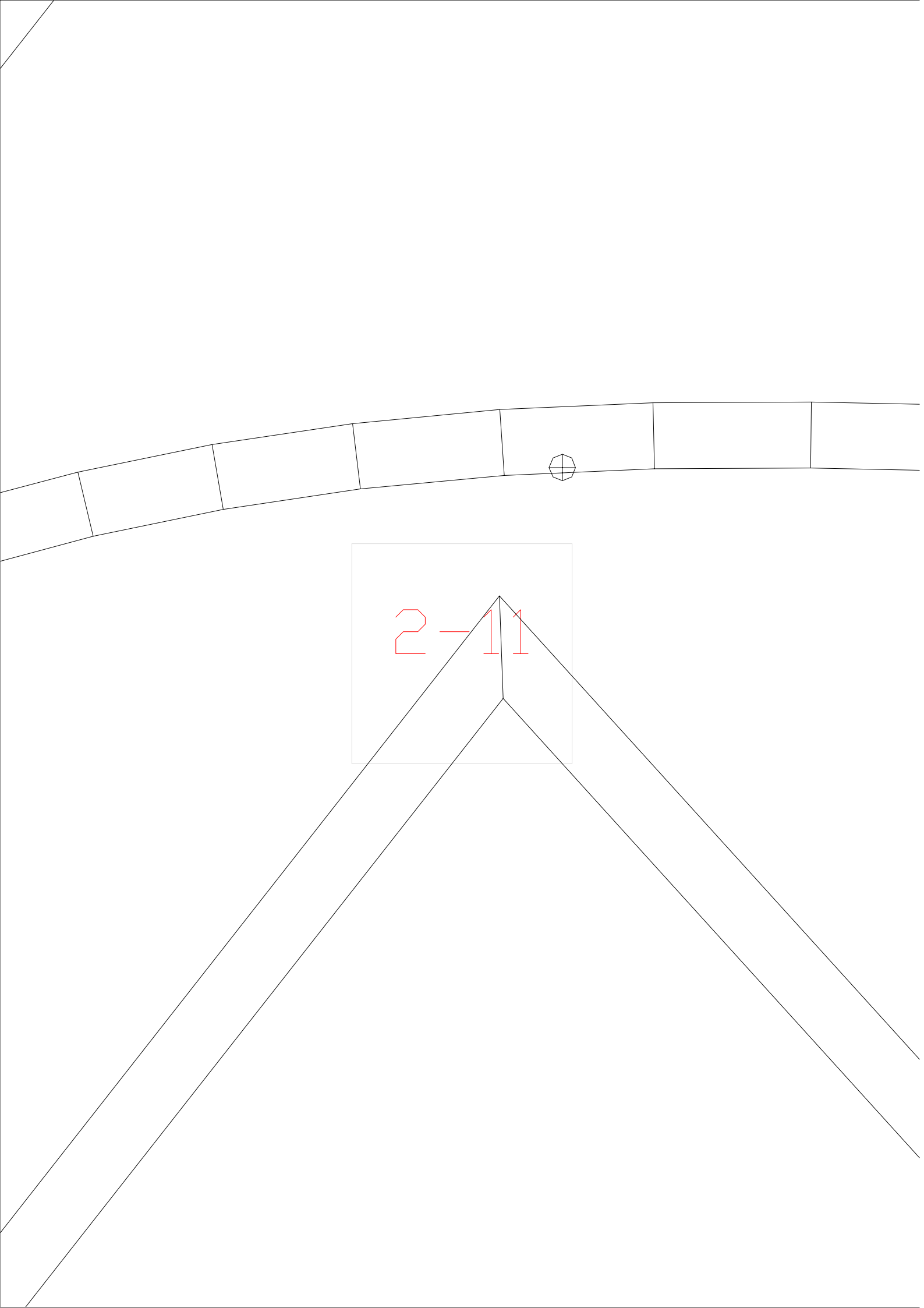

2-11

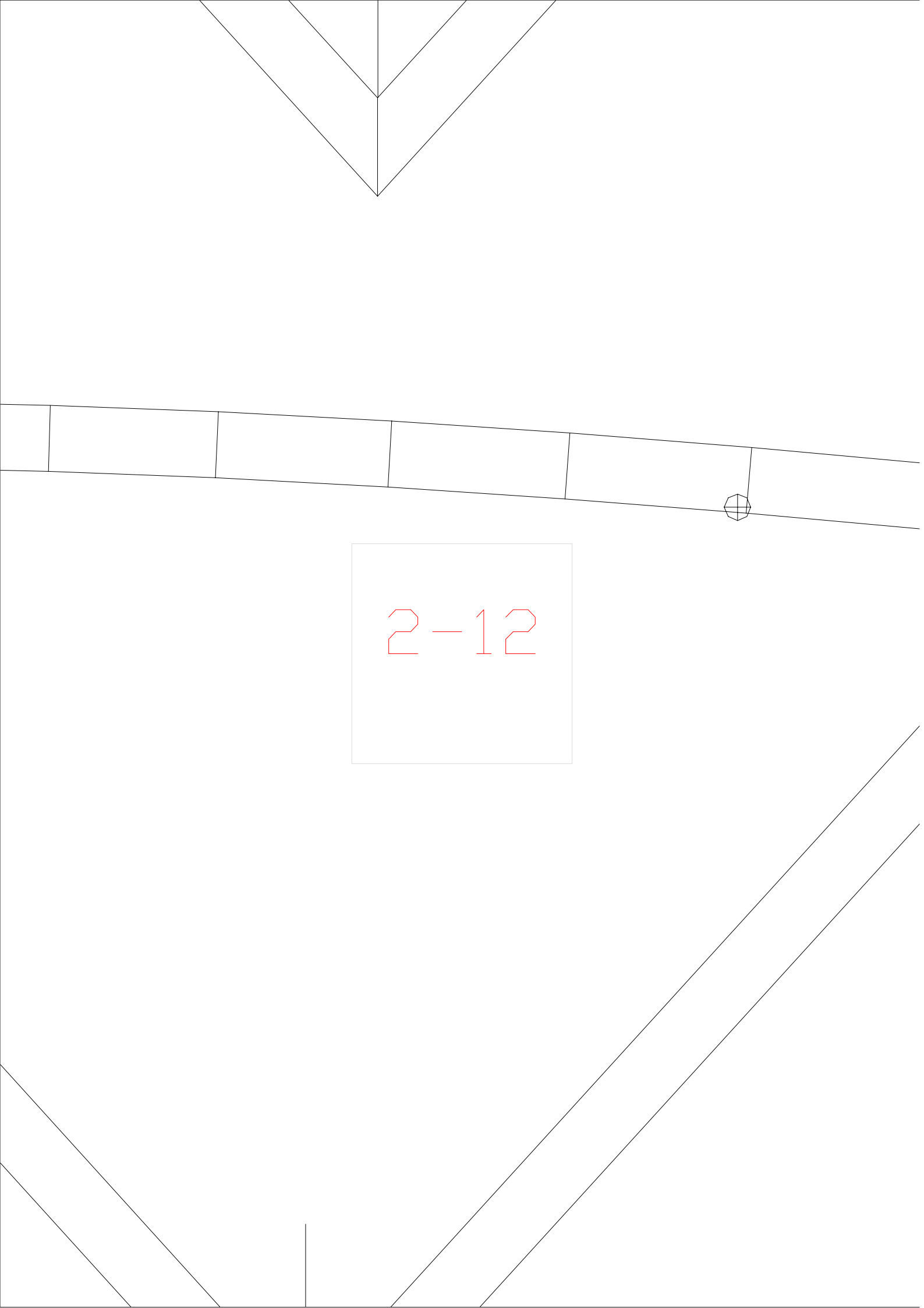

2-12

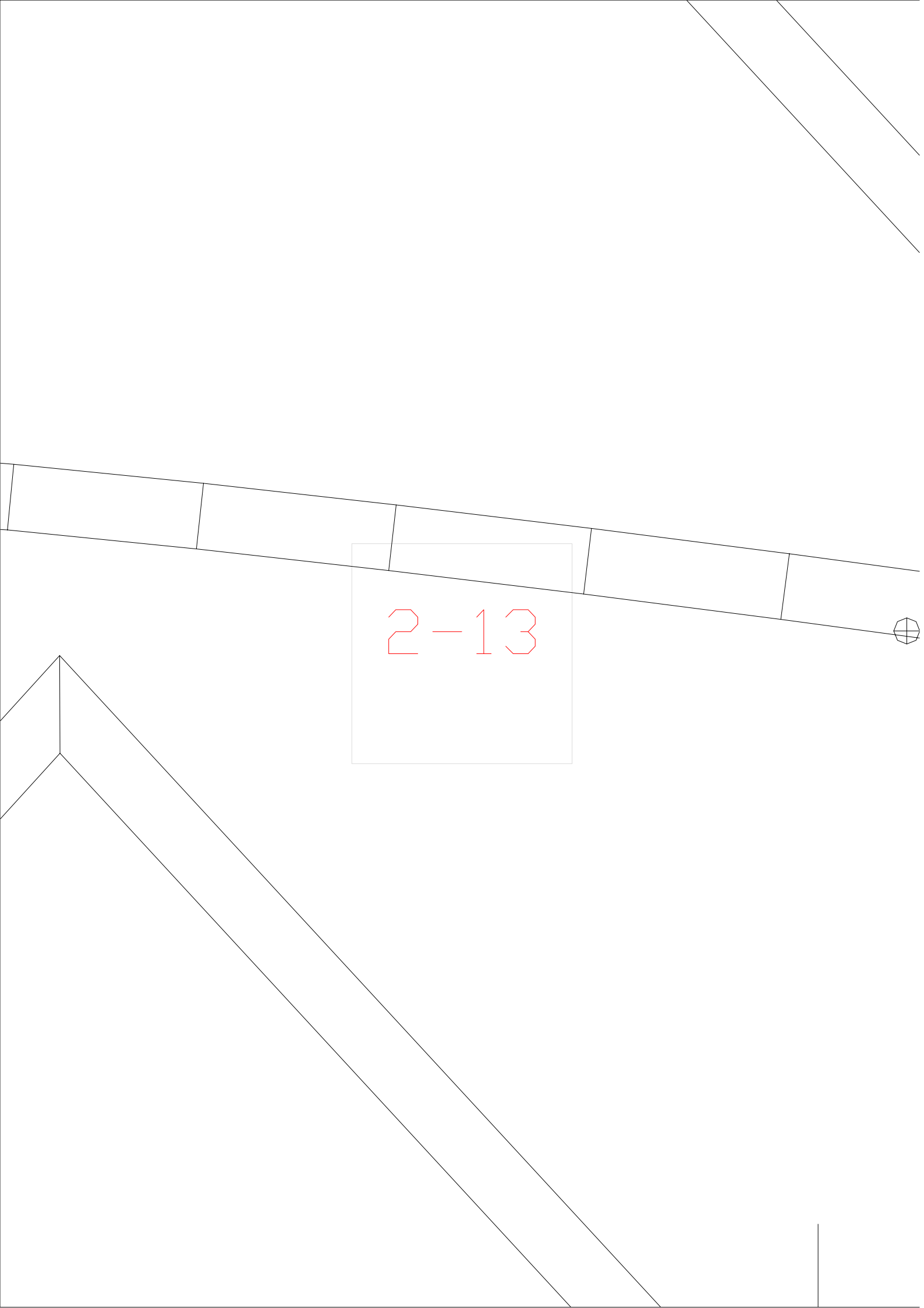

2-13

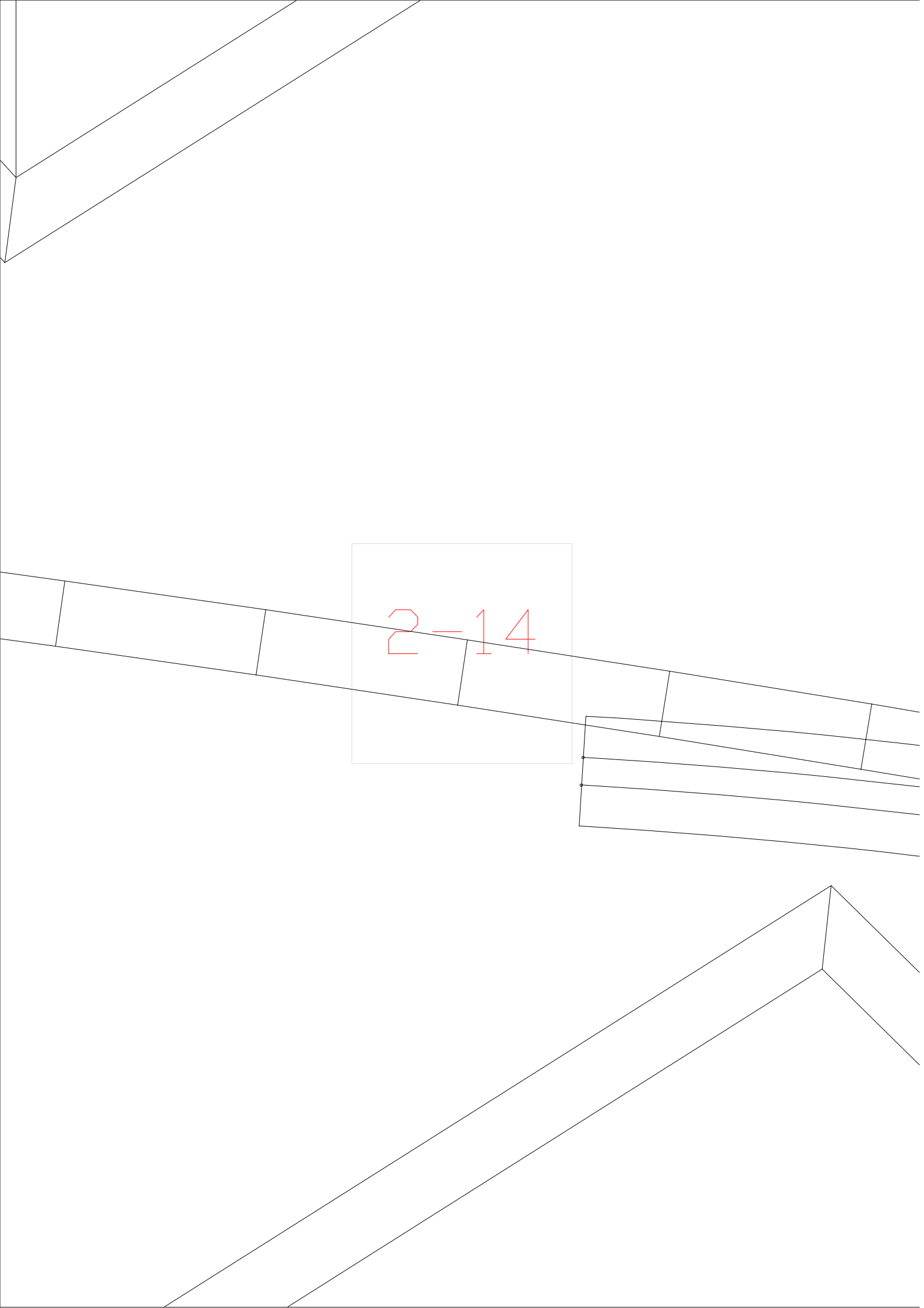

2-14

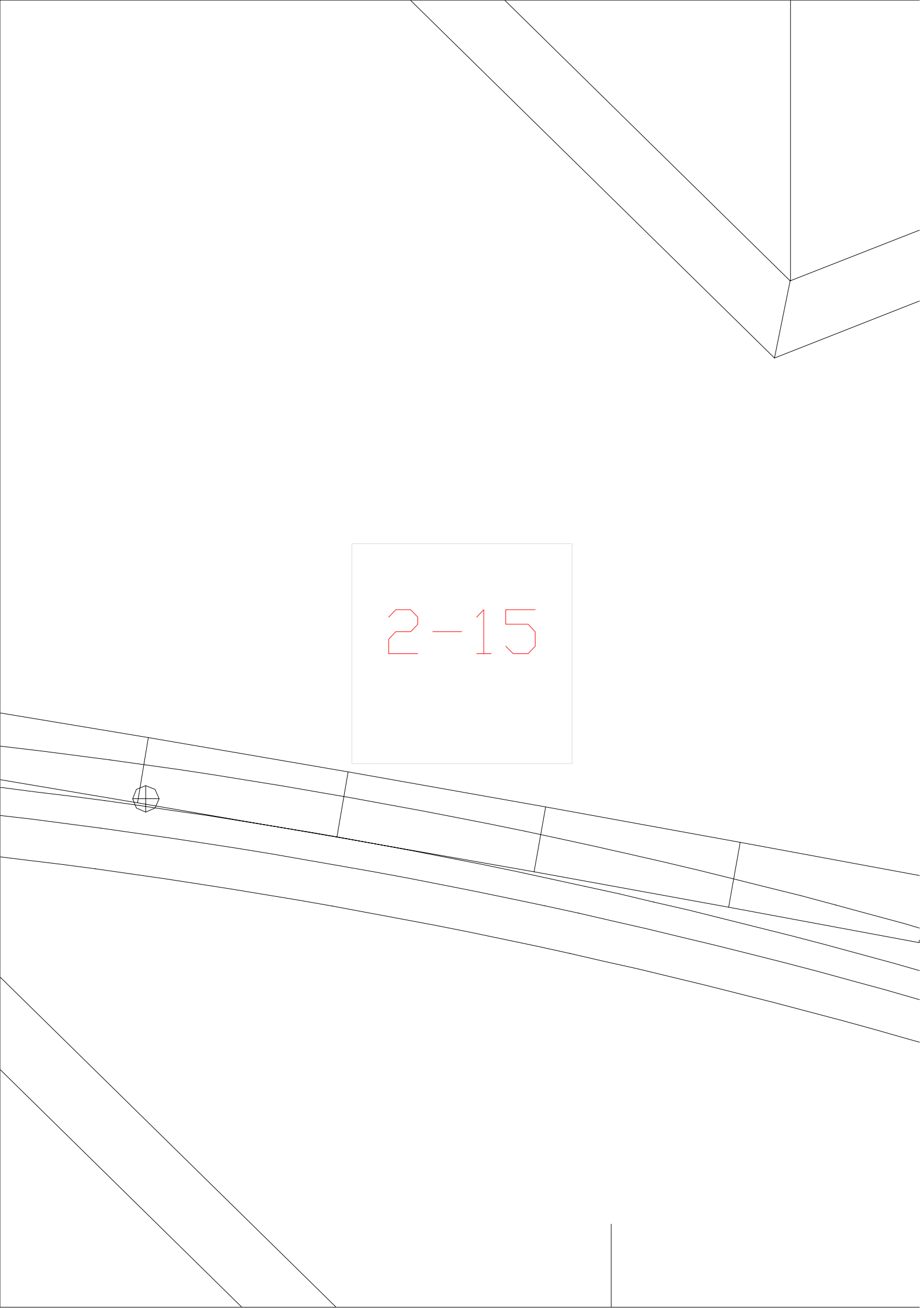

2-15

The image shows a technical drawing of a mechanical part, possibly a shaft or a beam, with a central label '2-15' in red. The drawing includes several lines representing the geometry of the part, including a central section with a circular feature and a section with a rectangular hole. The drawing is oriented vertically, with the top of the part at the top of the page. The label '2-15' is centered within a rectangular box in the middle of the drawing.

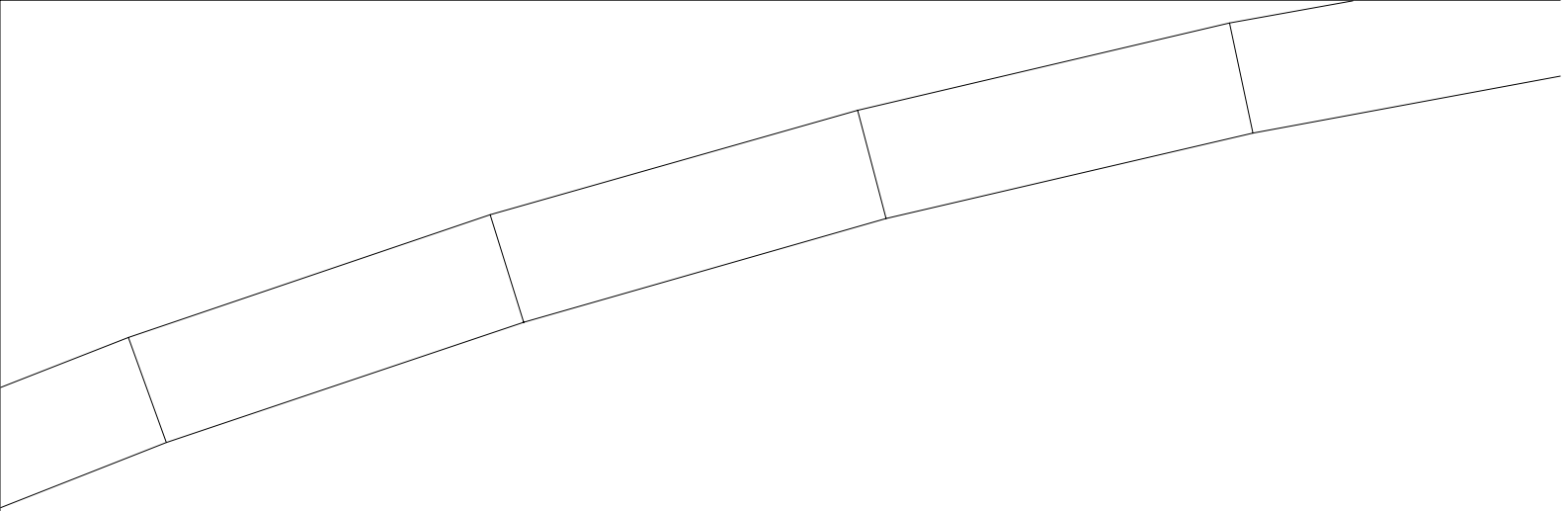

2-16

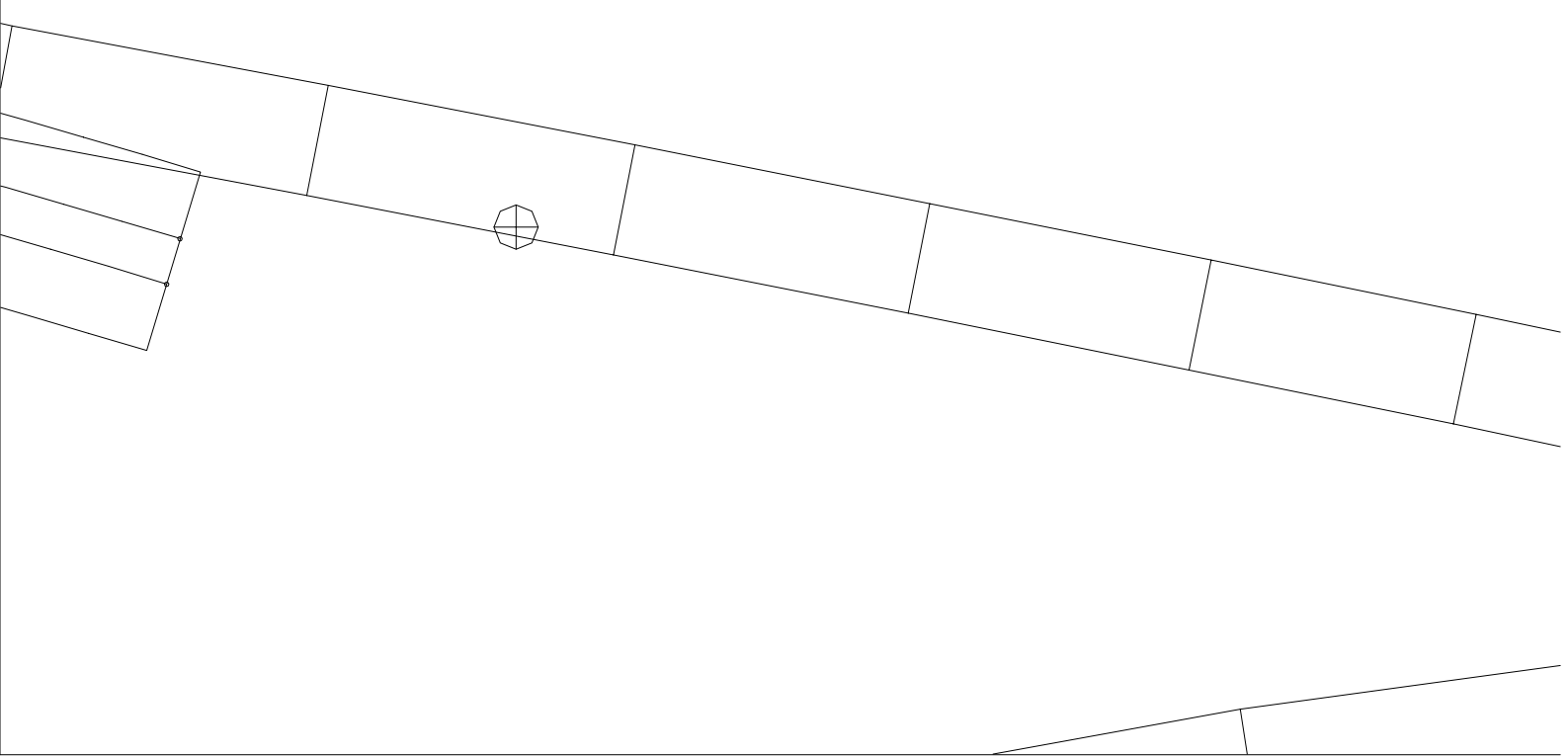

2-17

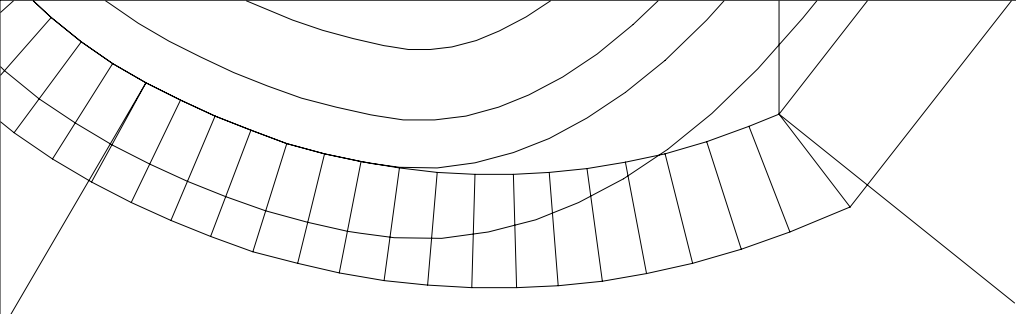

2-18

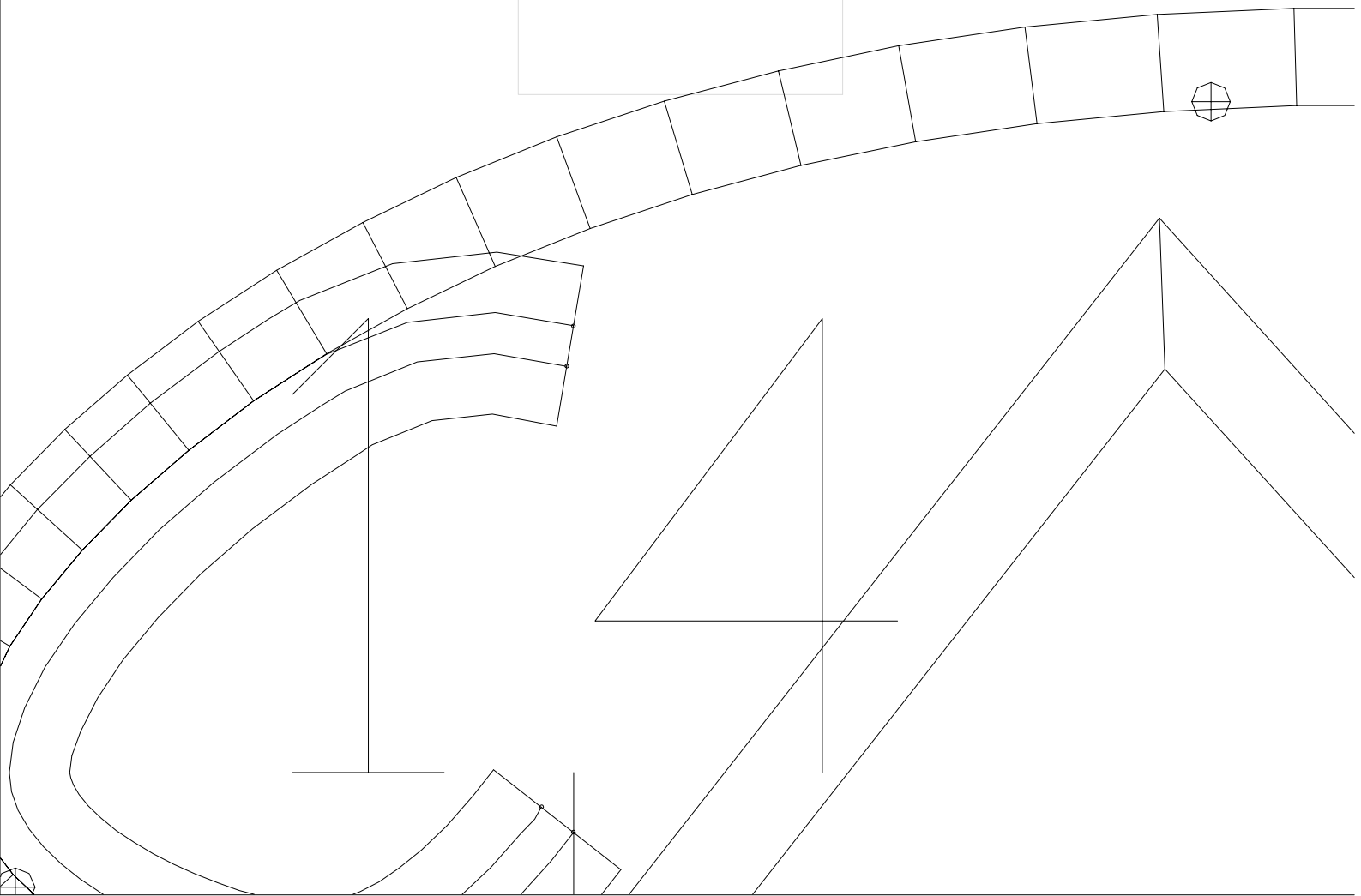

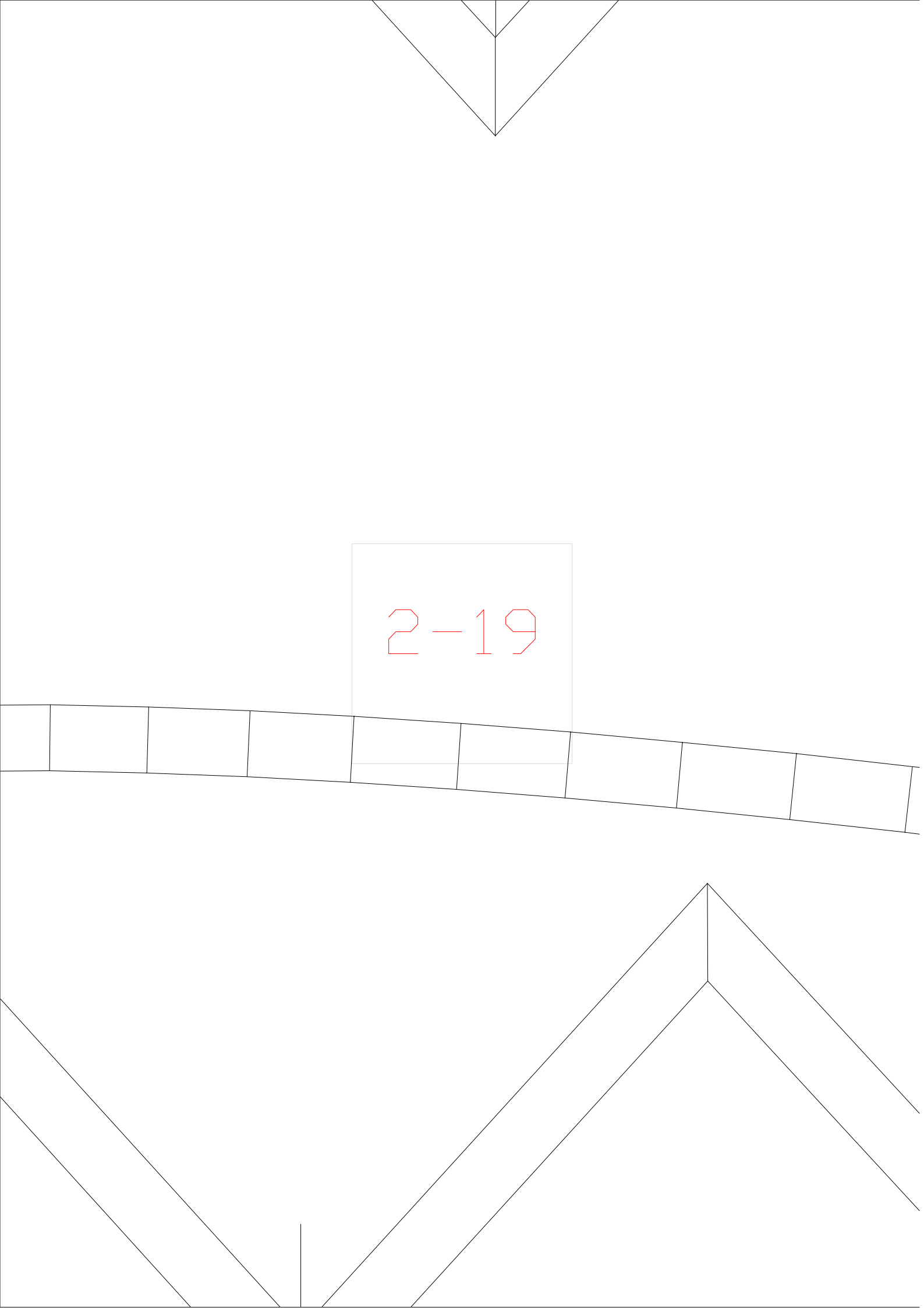

2-19

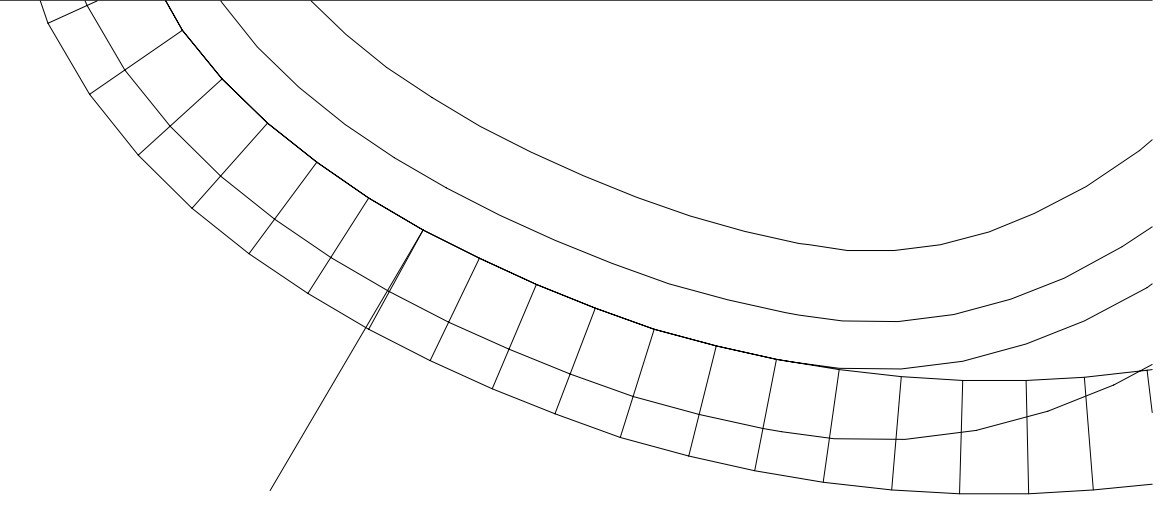

2-1

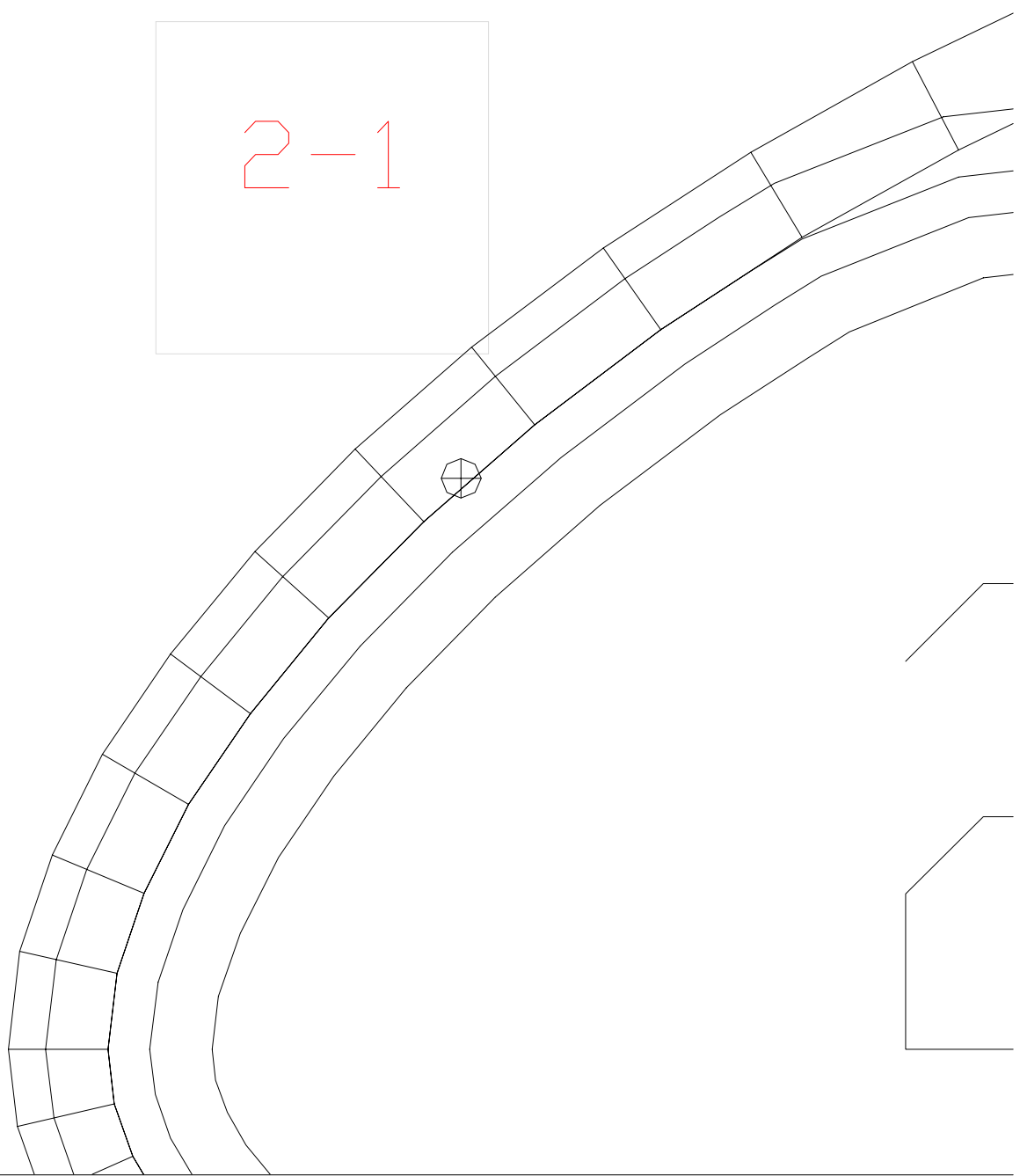

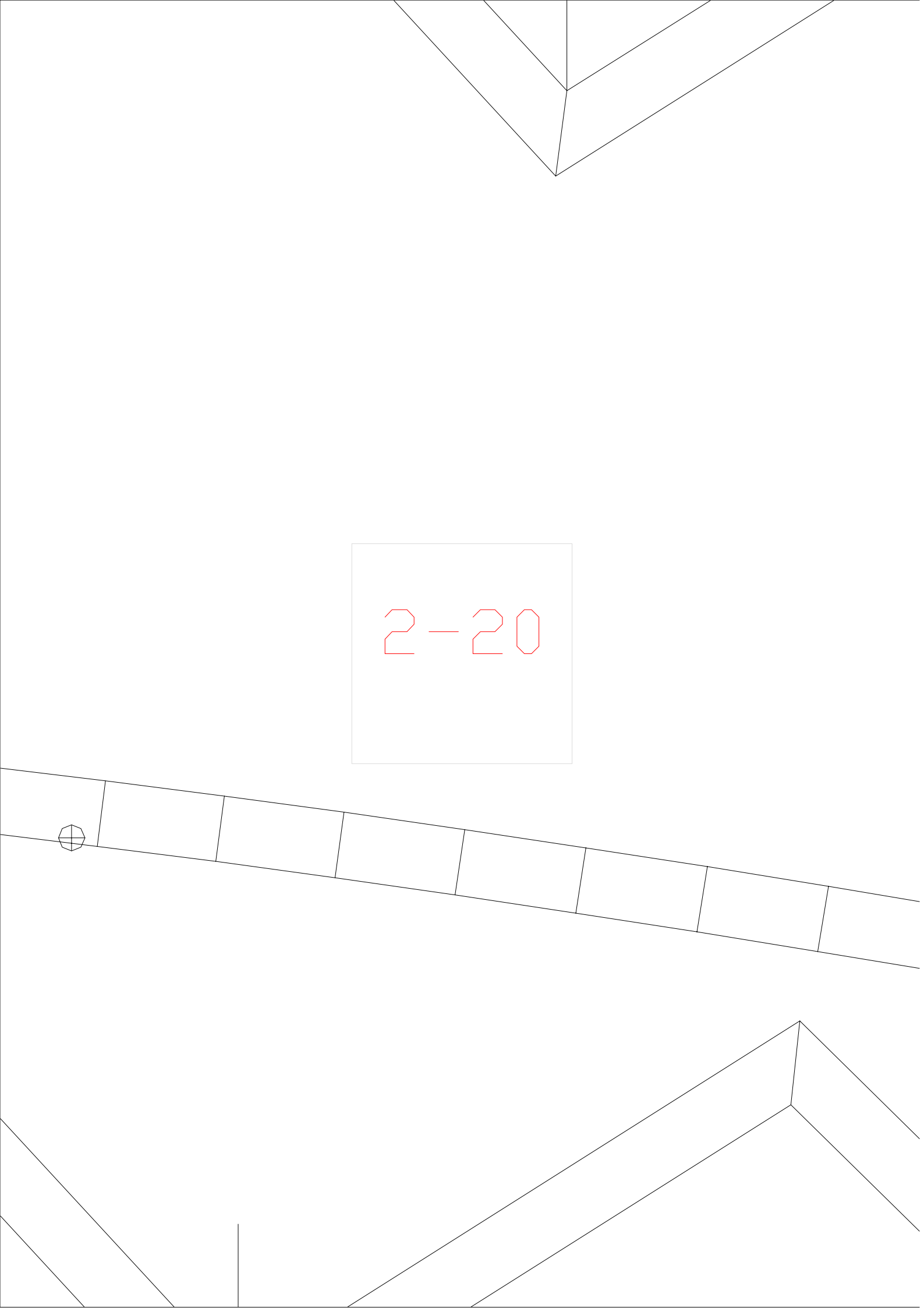

2-20

The image shows a technical drawing of a roof structure. At the top, there is a gable roof section. Below it, a large rectangular area contains the text '2-20' in red. Further down, a horizontal line represents a roof slope, divided into several rectangular segments. On the left side of this slope, there is a small circular detail with a cross inside. At the bottom, another gable roof section is shown, mirroring the one at the top.

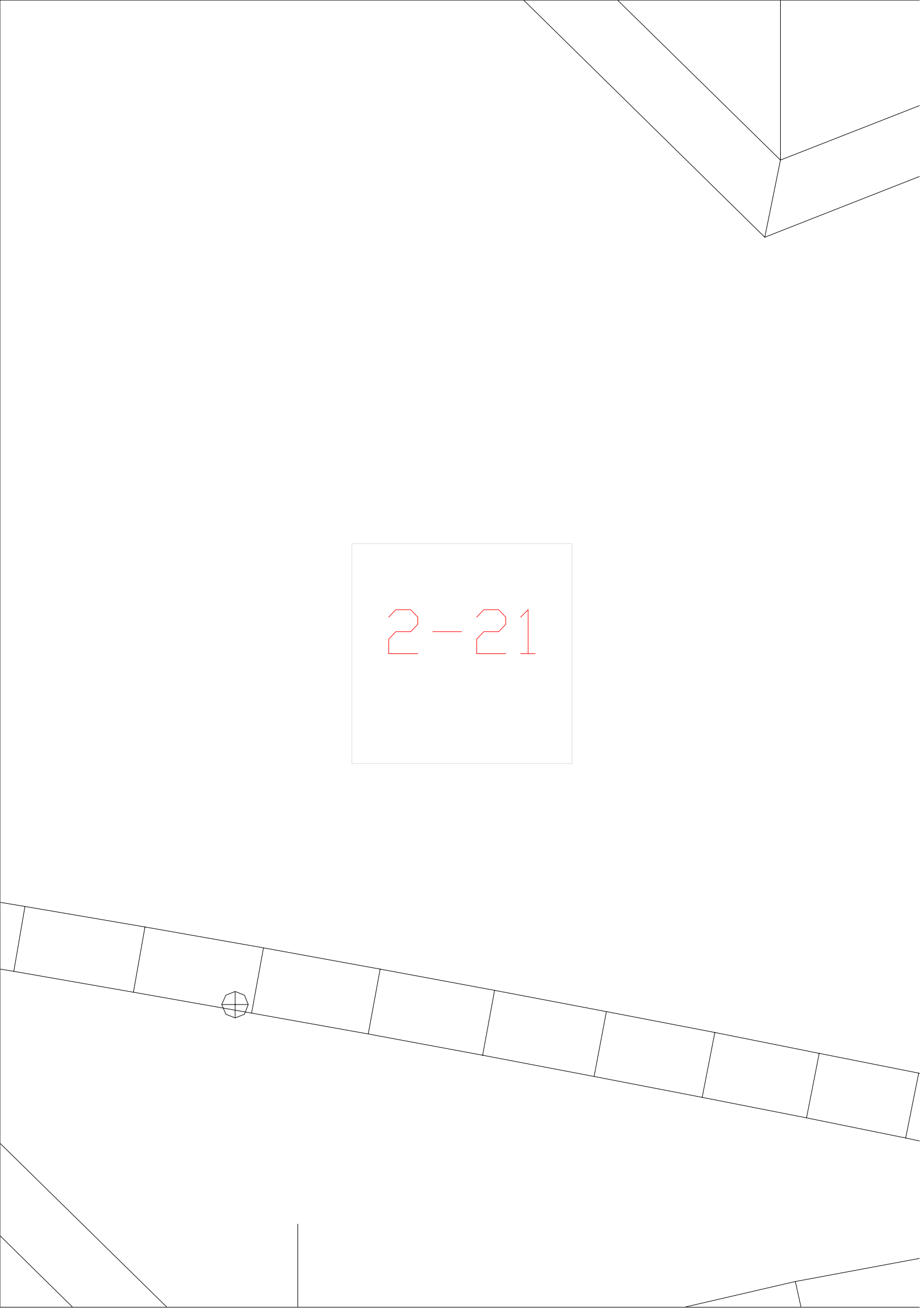

2-21

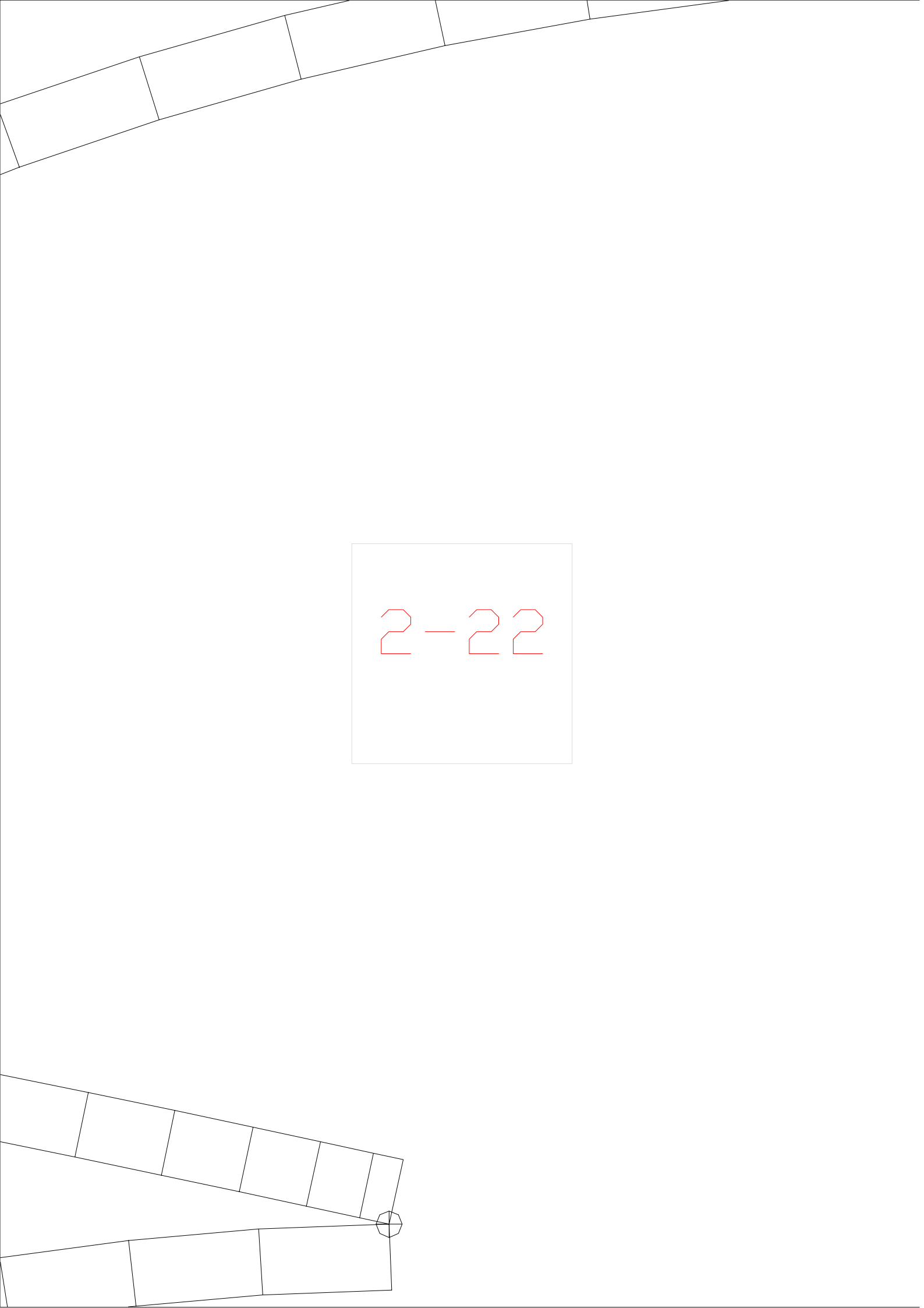

2-22

2-23

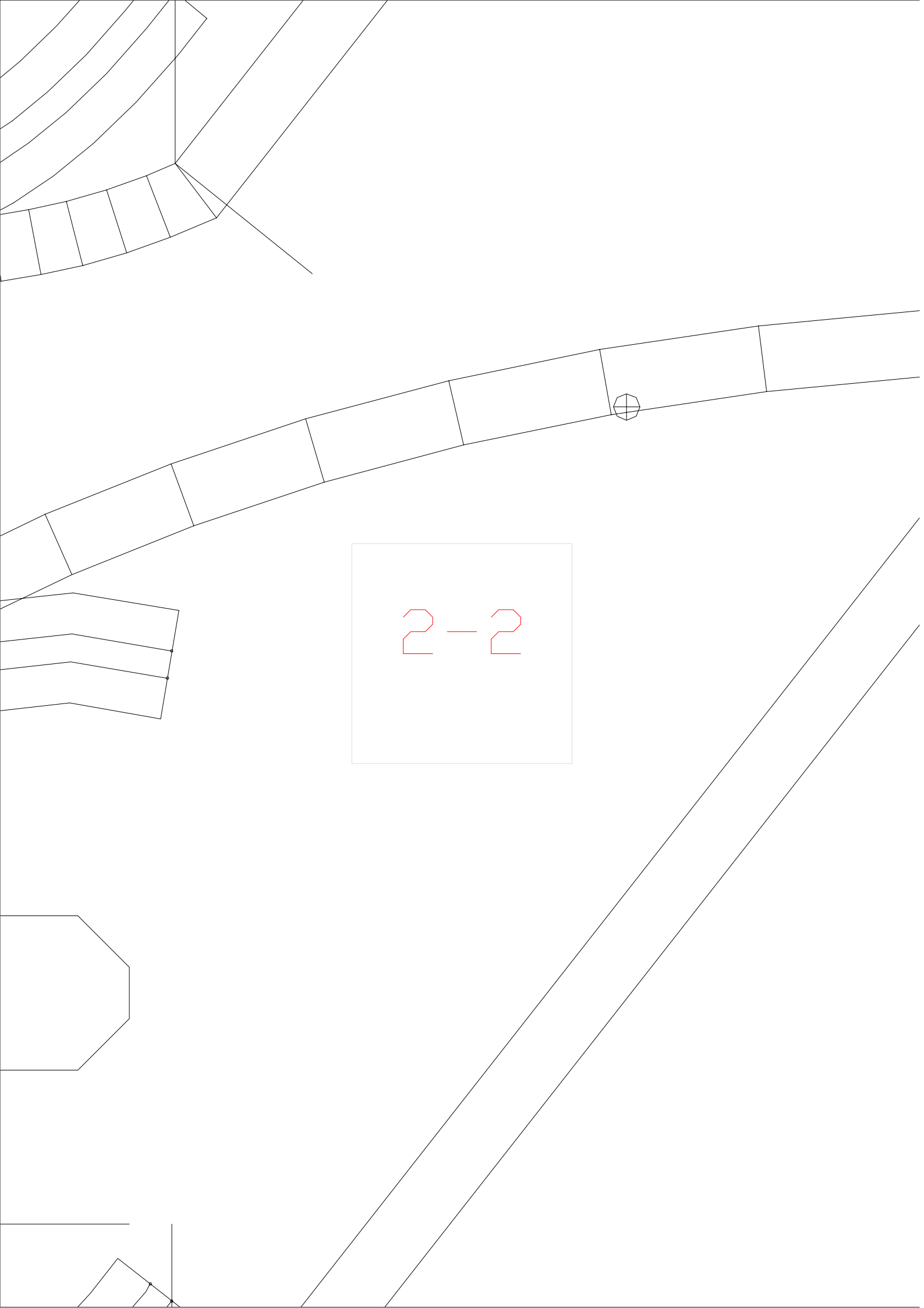

2-2

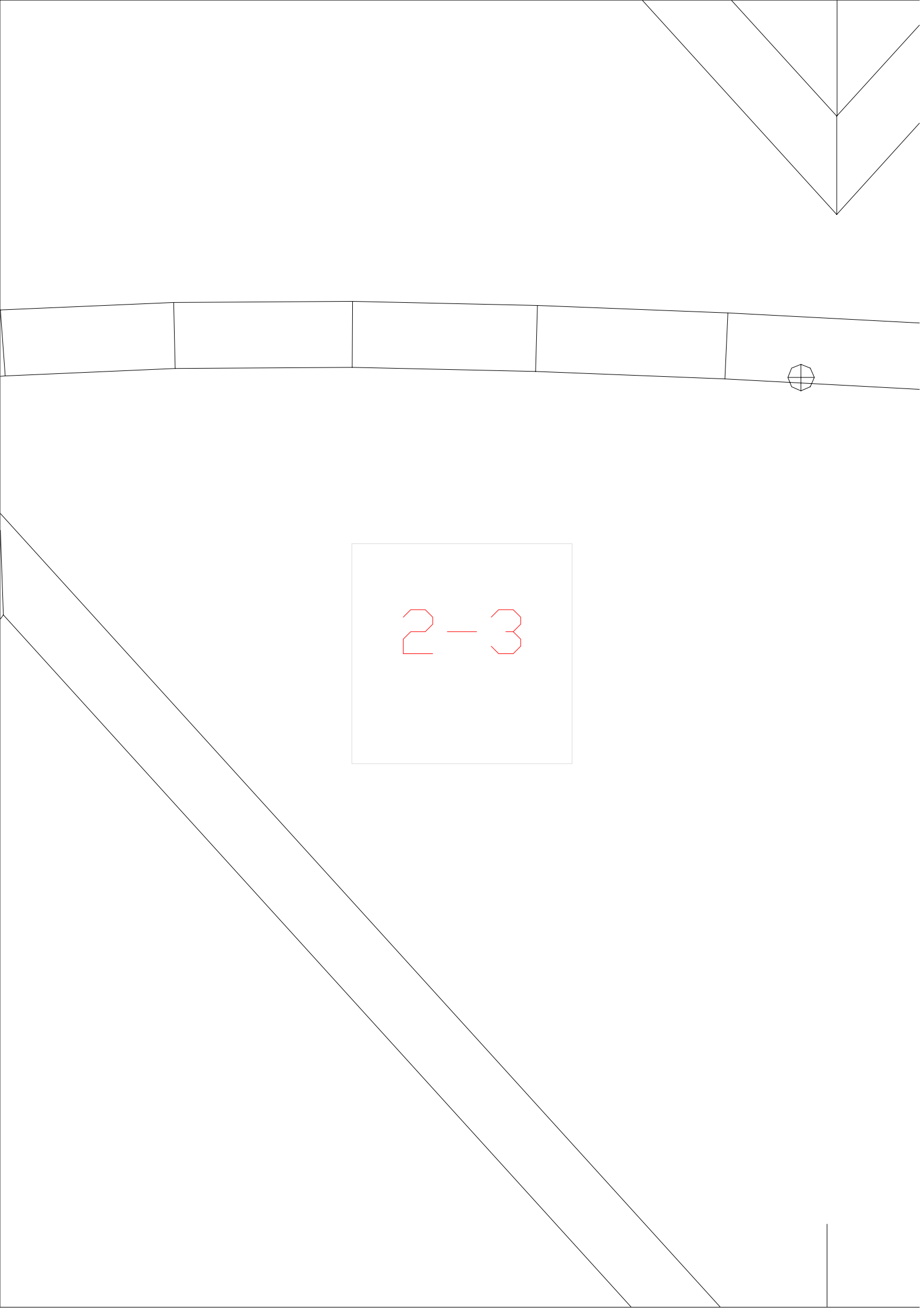

2-3

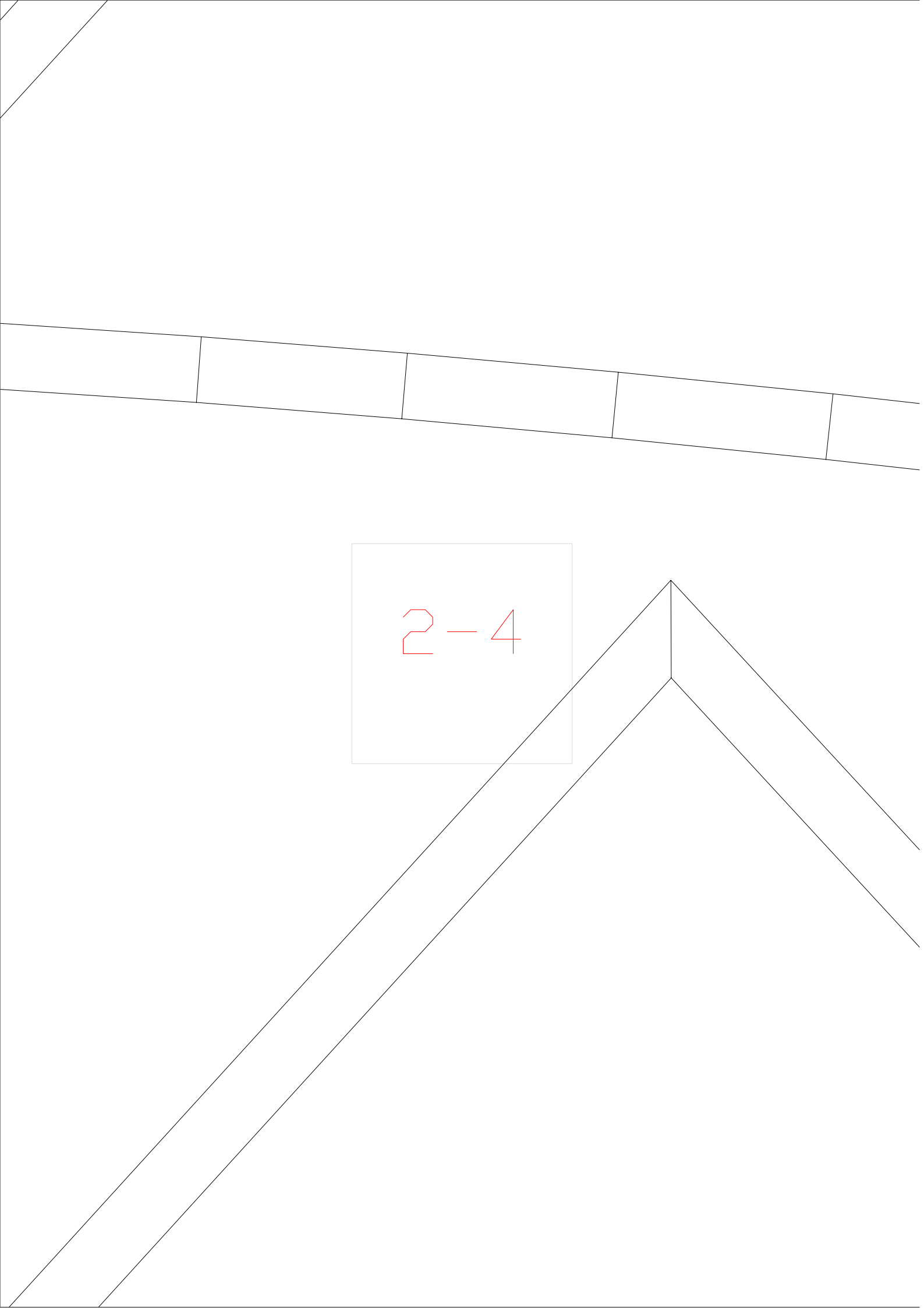

2-4



2-5

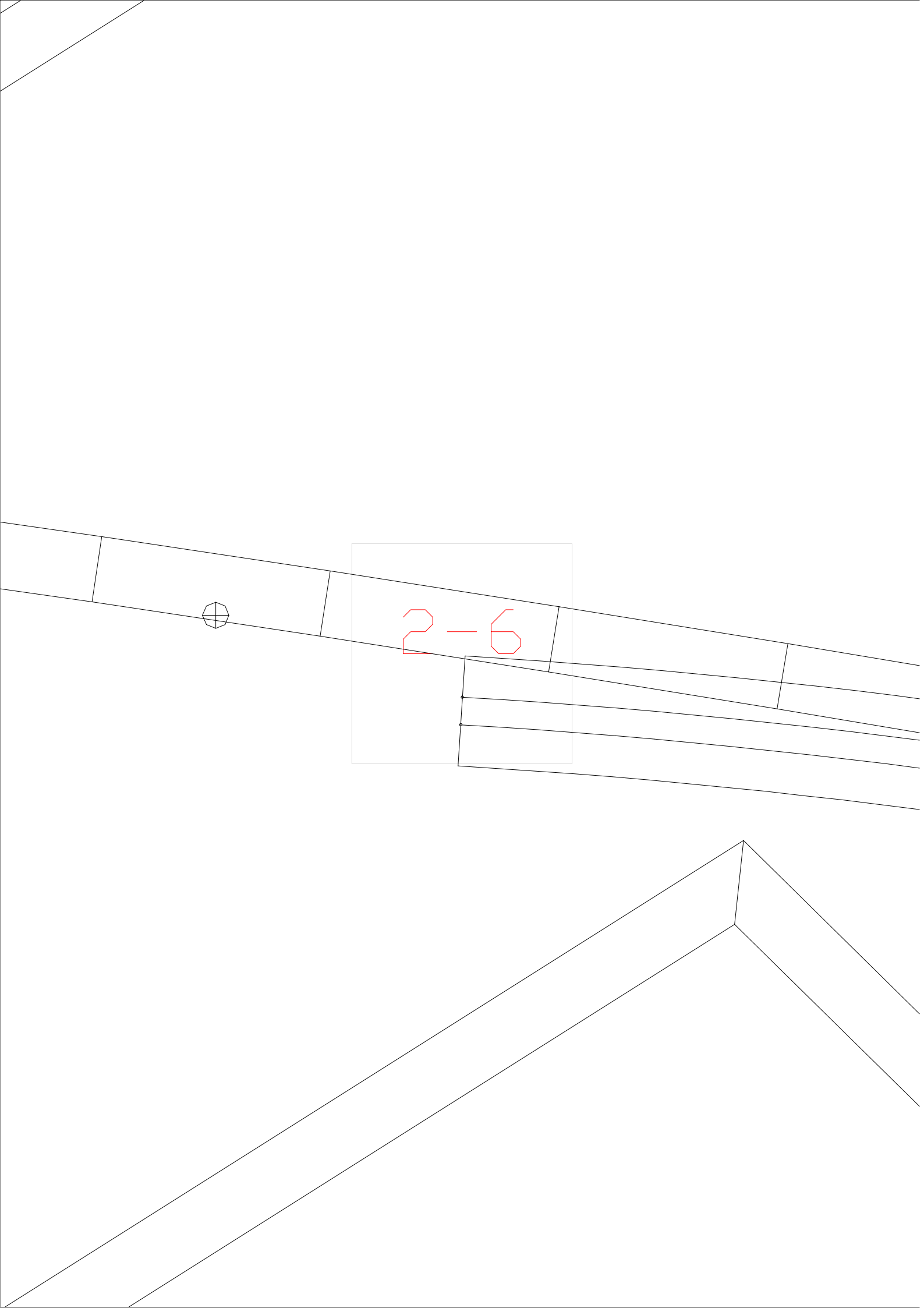

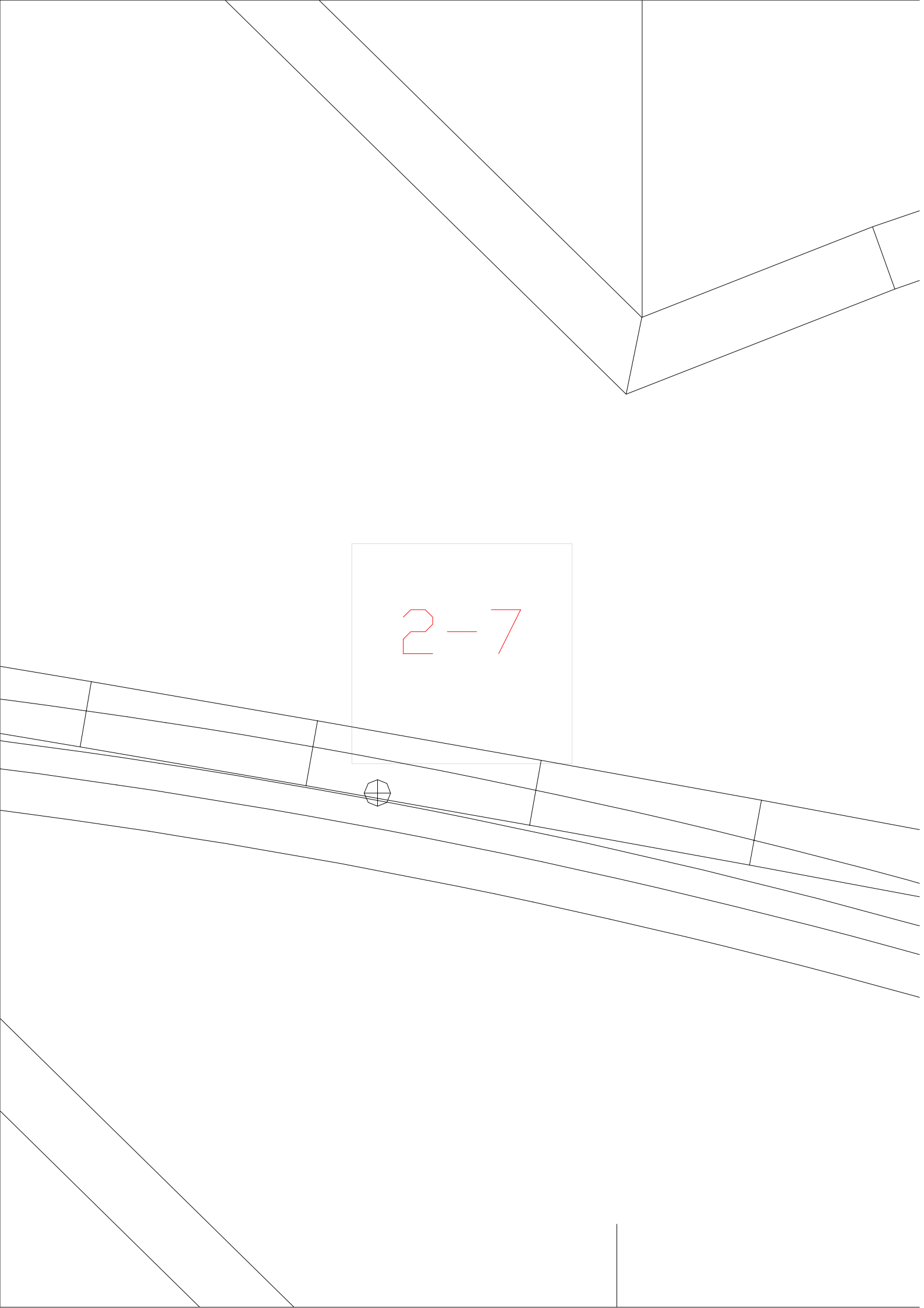

2-7

The image shows a technical drawing of a mechanical part. It features a central square with the text "2-7" inside. Below the square is a horizontal bar with a hole in the center. The drawing includes various lines and shapes representing the geometry of the part.

2-8



2-9

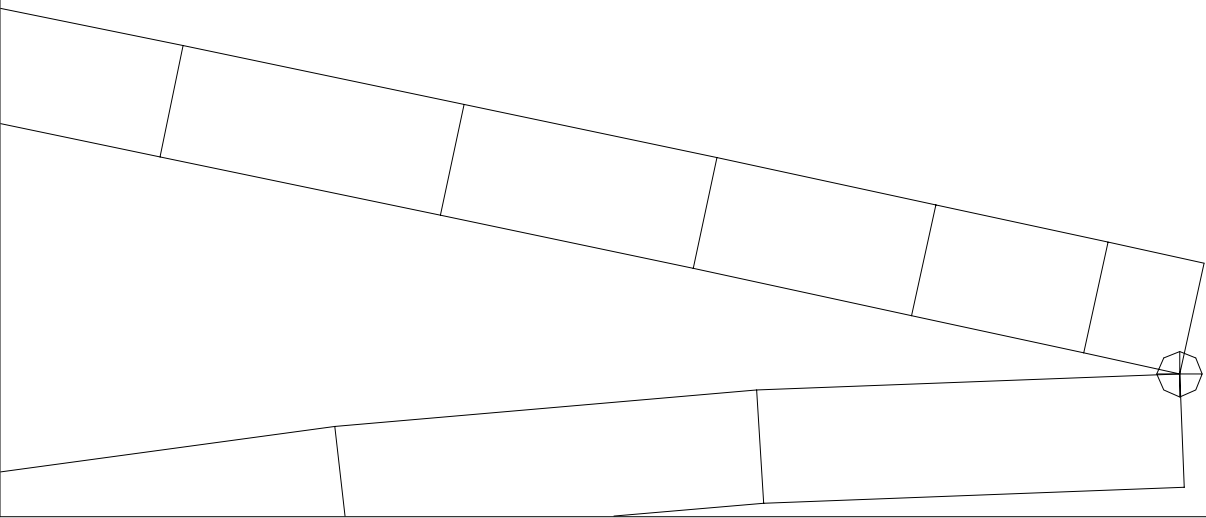

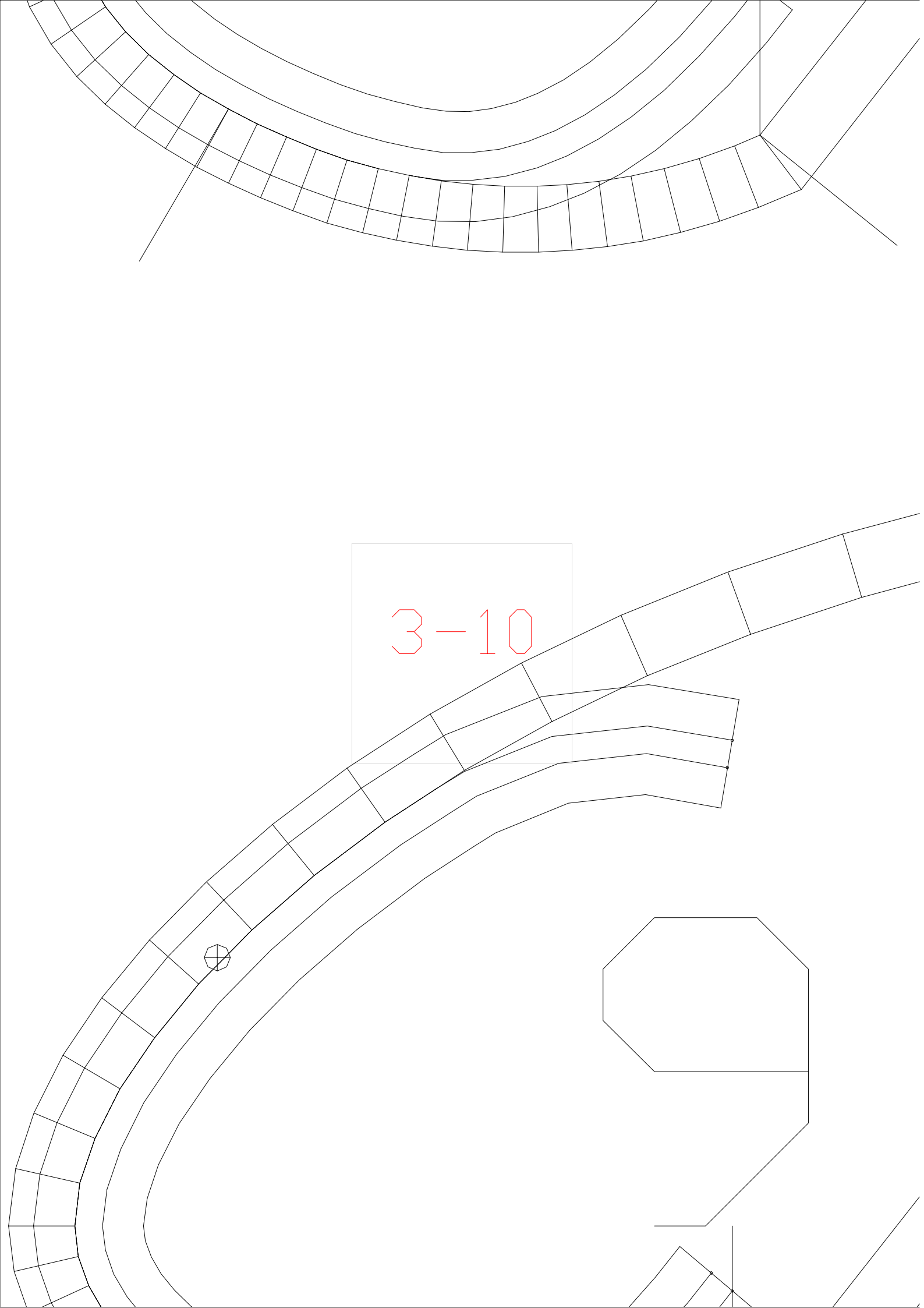

3-10

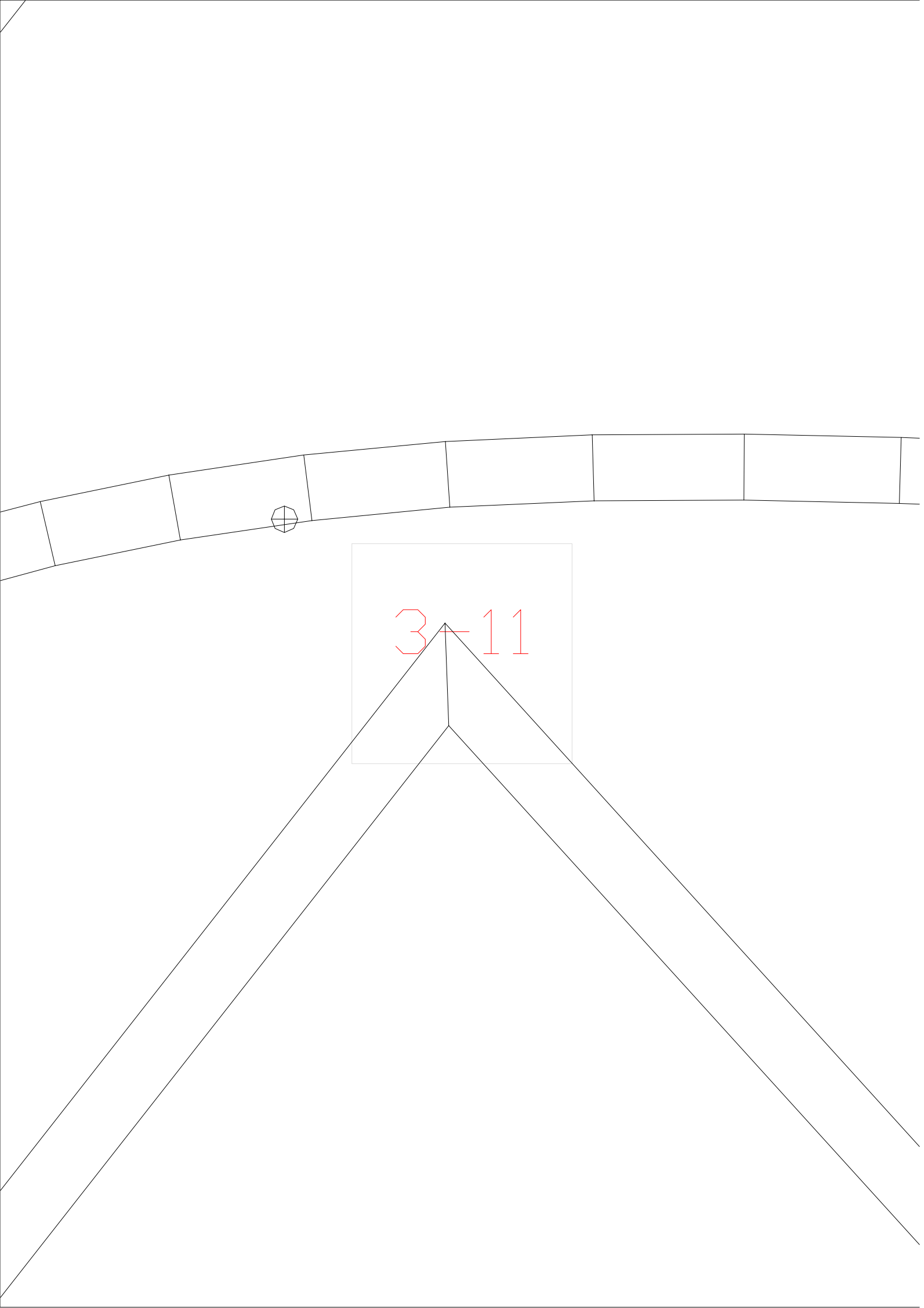

3-11

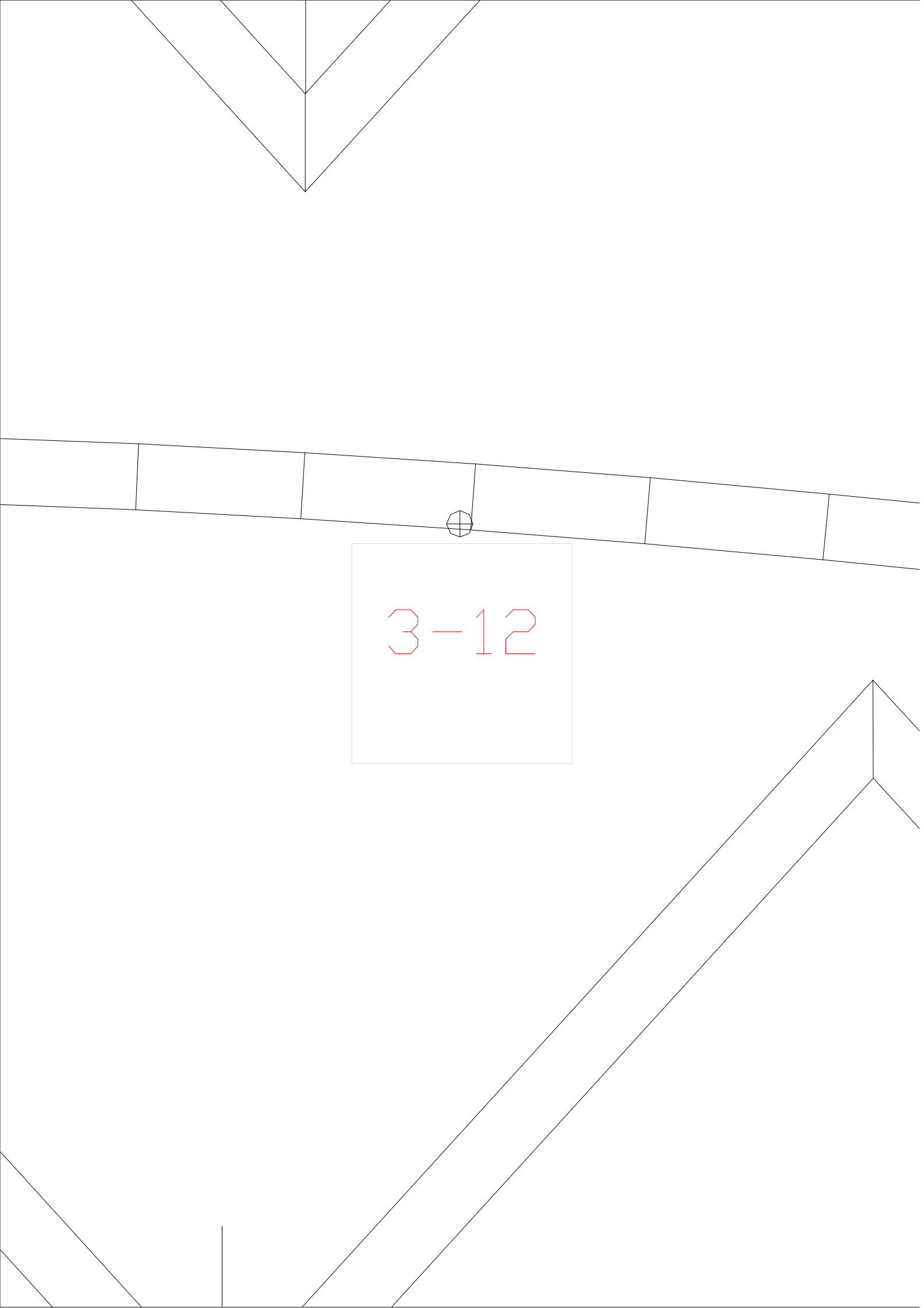

3-12

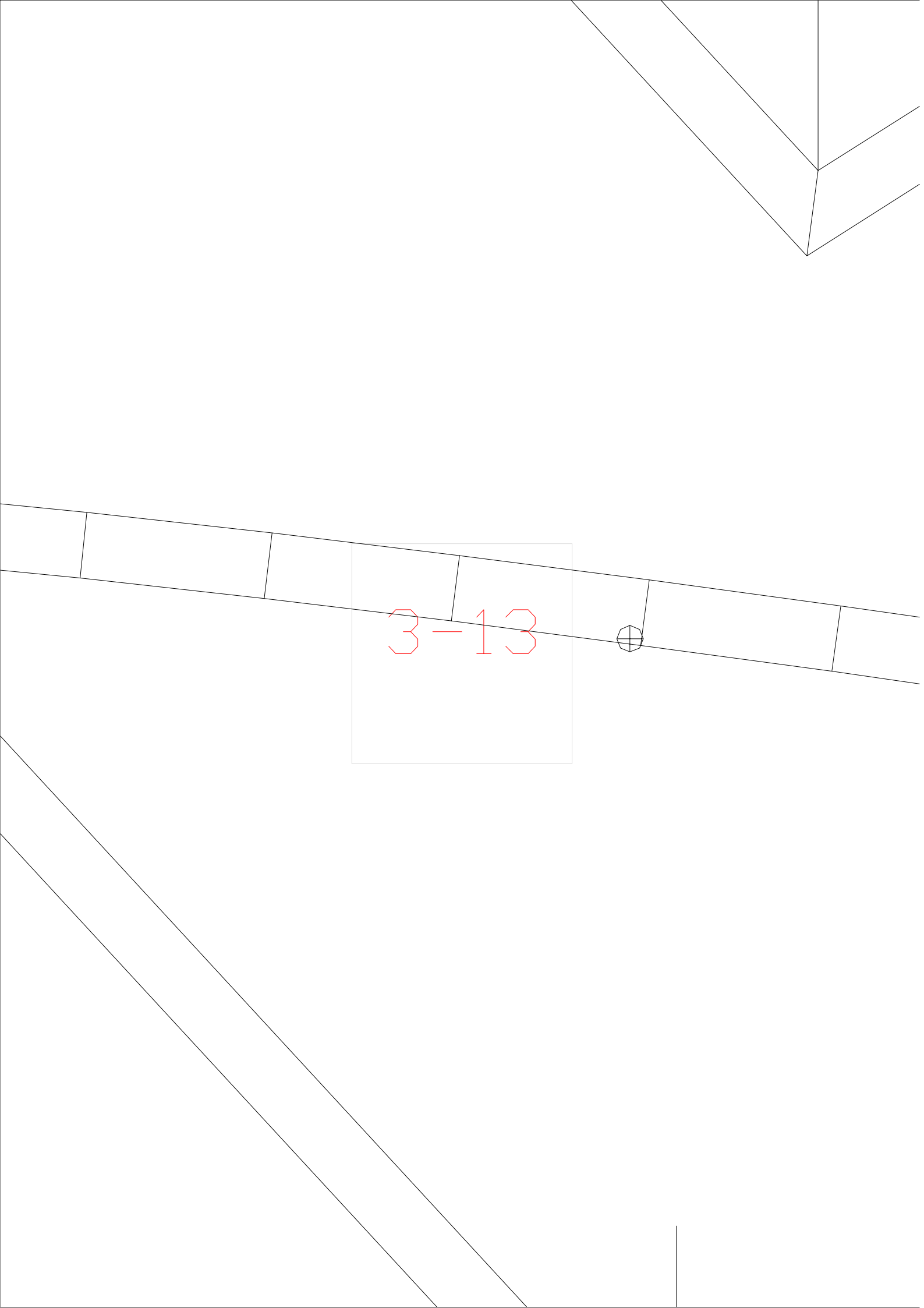

3-13

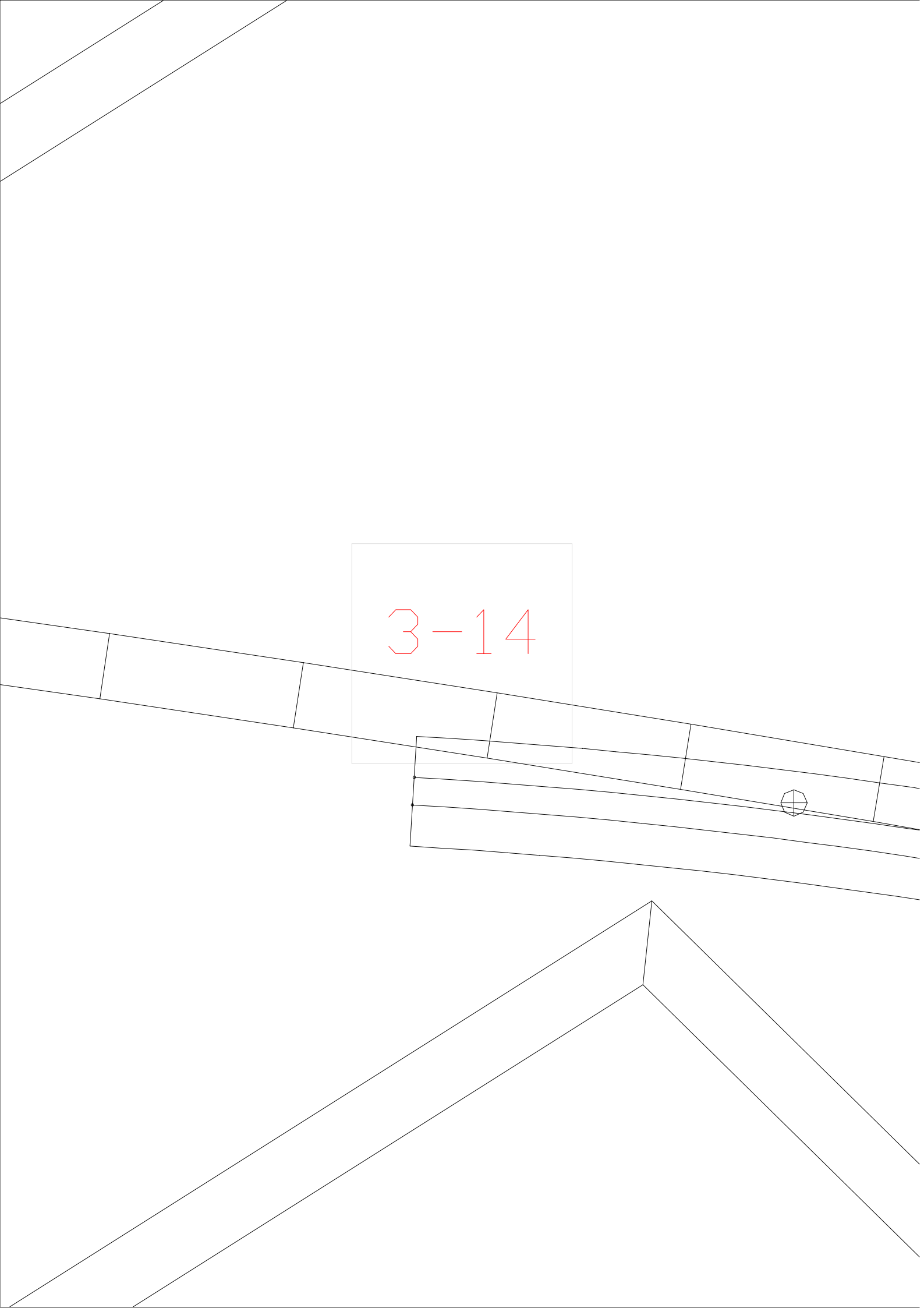

3-14

The image shows a technical drawing of a mechanical part, possibly a shaft or a beam, with a callout box. The part is shown in a perspective view, with a central section highlighted by a light gray box. The text '3-14' is written in red inside this box. The drawing includes several lines representing the geometry of the part, including a central section with a circular feature and a section with a rectangular feature. The drawing is oriented vertically on the page.

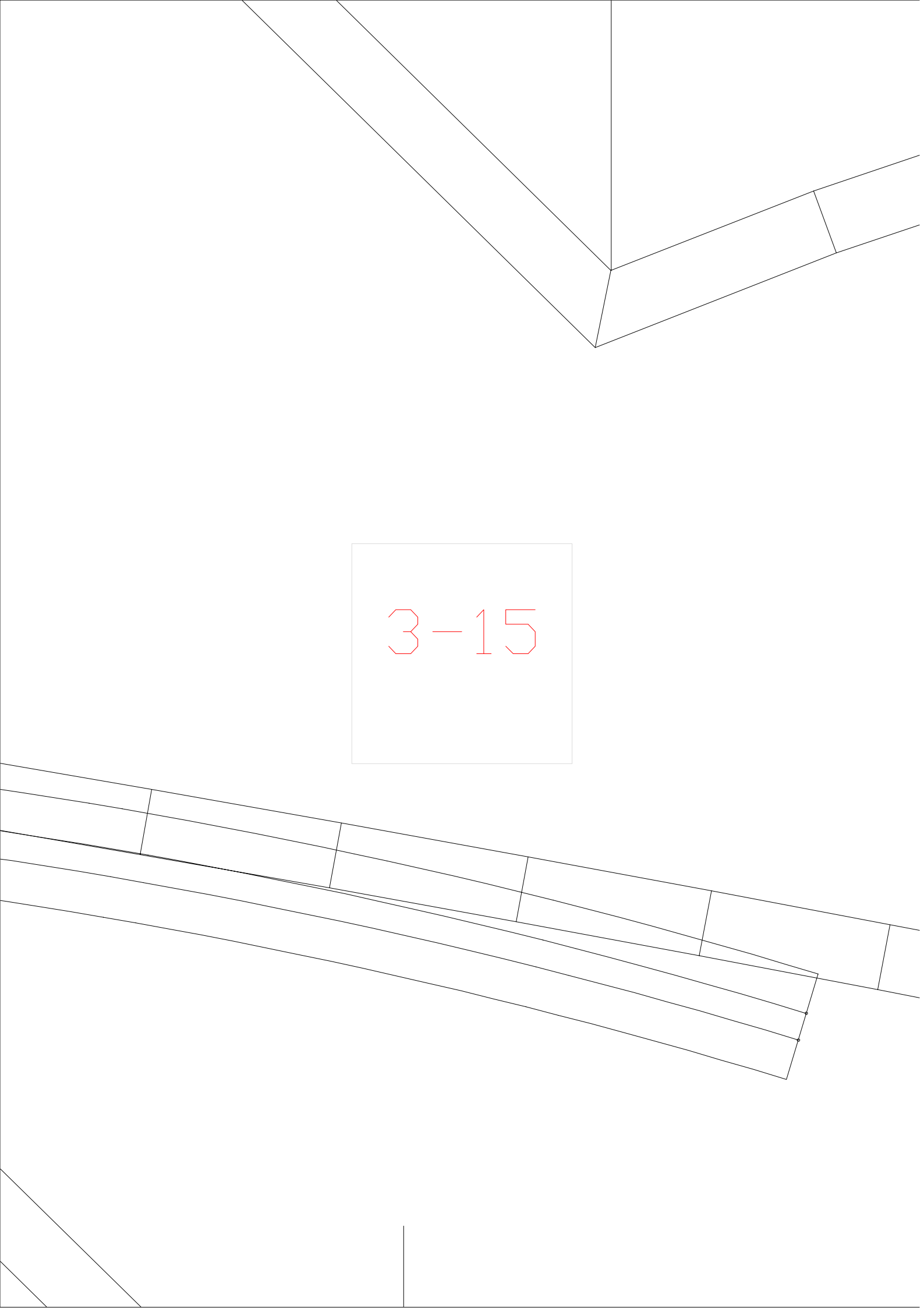

3-15

The image shows a technical drawing of a corner joint. At the top, two rectangular sections meet at a 90-degree angle. The top-left section is shaded light gray. The top-right section is also shaded light gray and contains a small rectangular detail. In the center, a white rectangular box contains the red text '3-15'. Below this, a long, narrow rectangular section is shown, divided into several segments by vertical lines. This section is also shaded light gray. At the bottom, a vertical line is drawn, and a diagonal line is visible in the bottom-left corner.

3-16

The image shows a technical drawing of a curved structure, possibly a pipe or duct, with a central label '3-16'. The structure is composed of several rectangular segments arranged in a curve. A small circular symbol with a cross inside is located on the left side of the lower curve. The drawing is a line drawing with no shading or color.

3-17

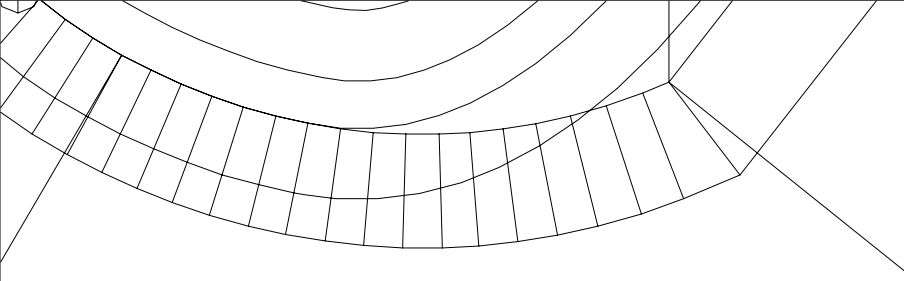

3-18

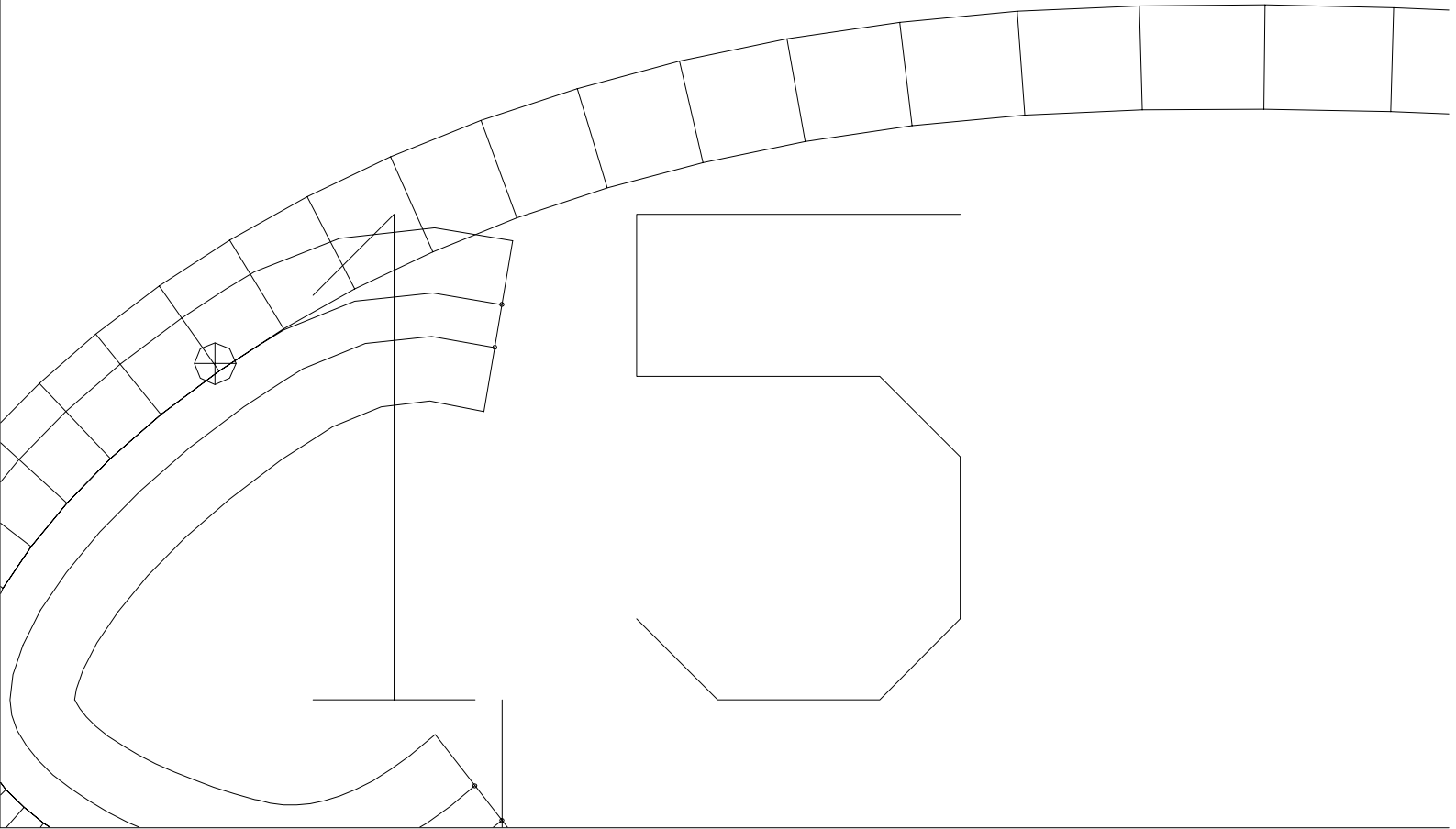

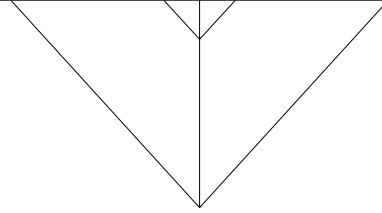

3-19

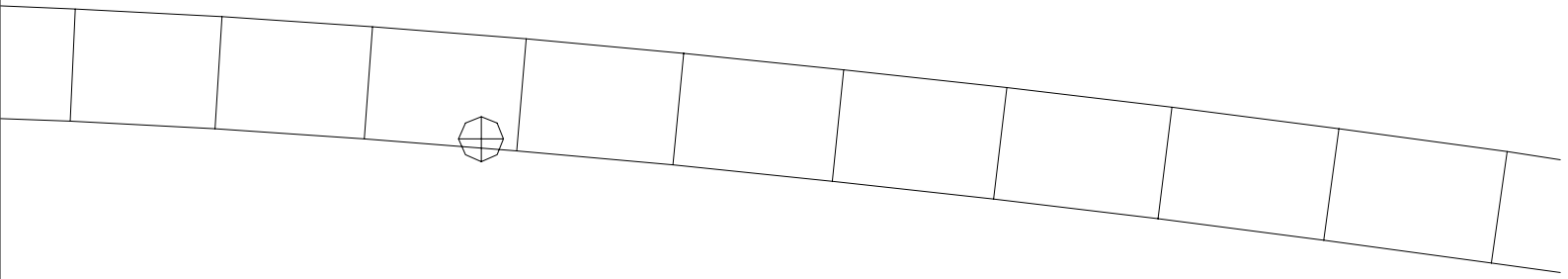

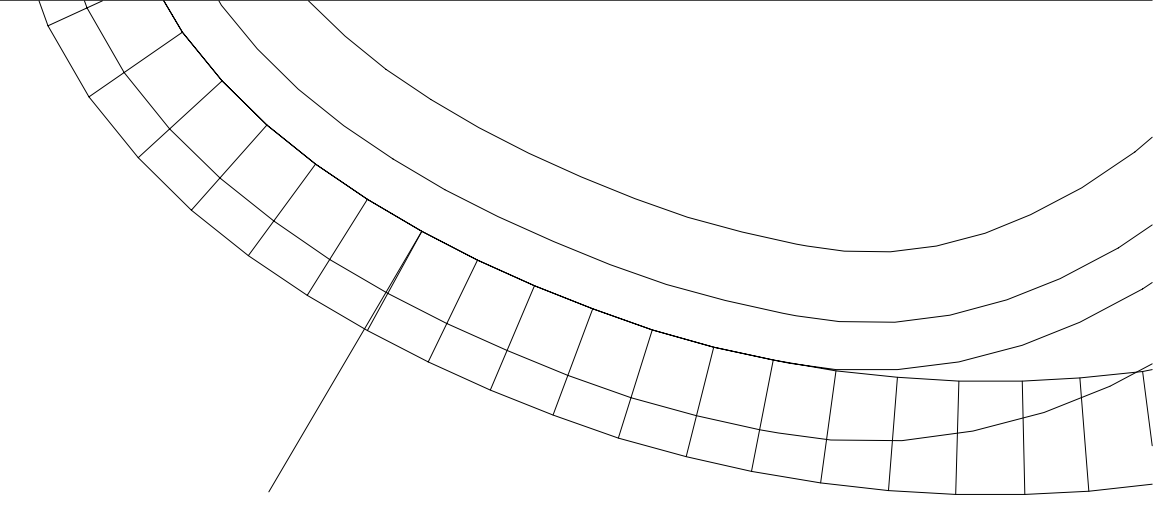

3-1

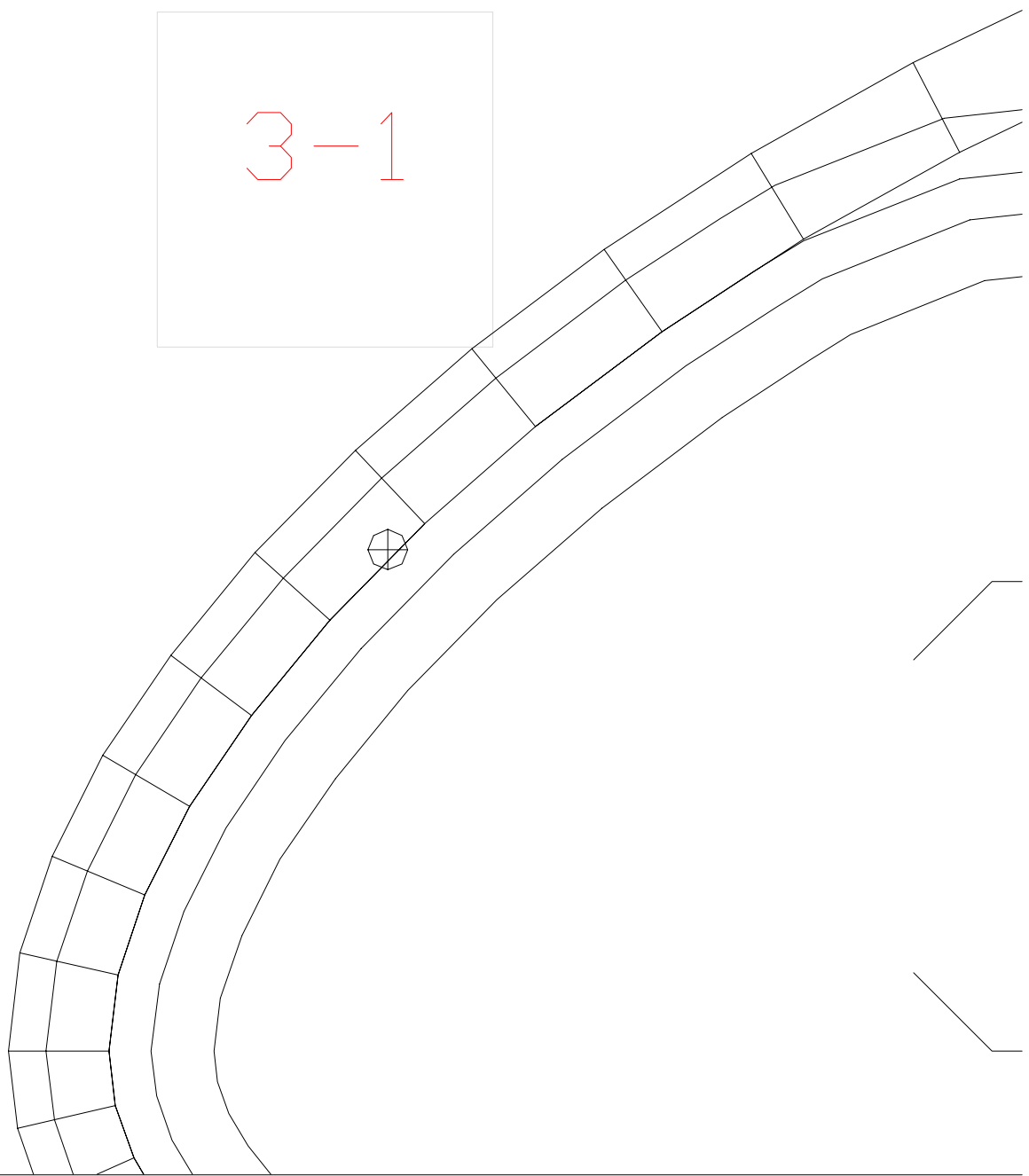

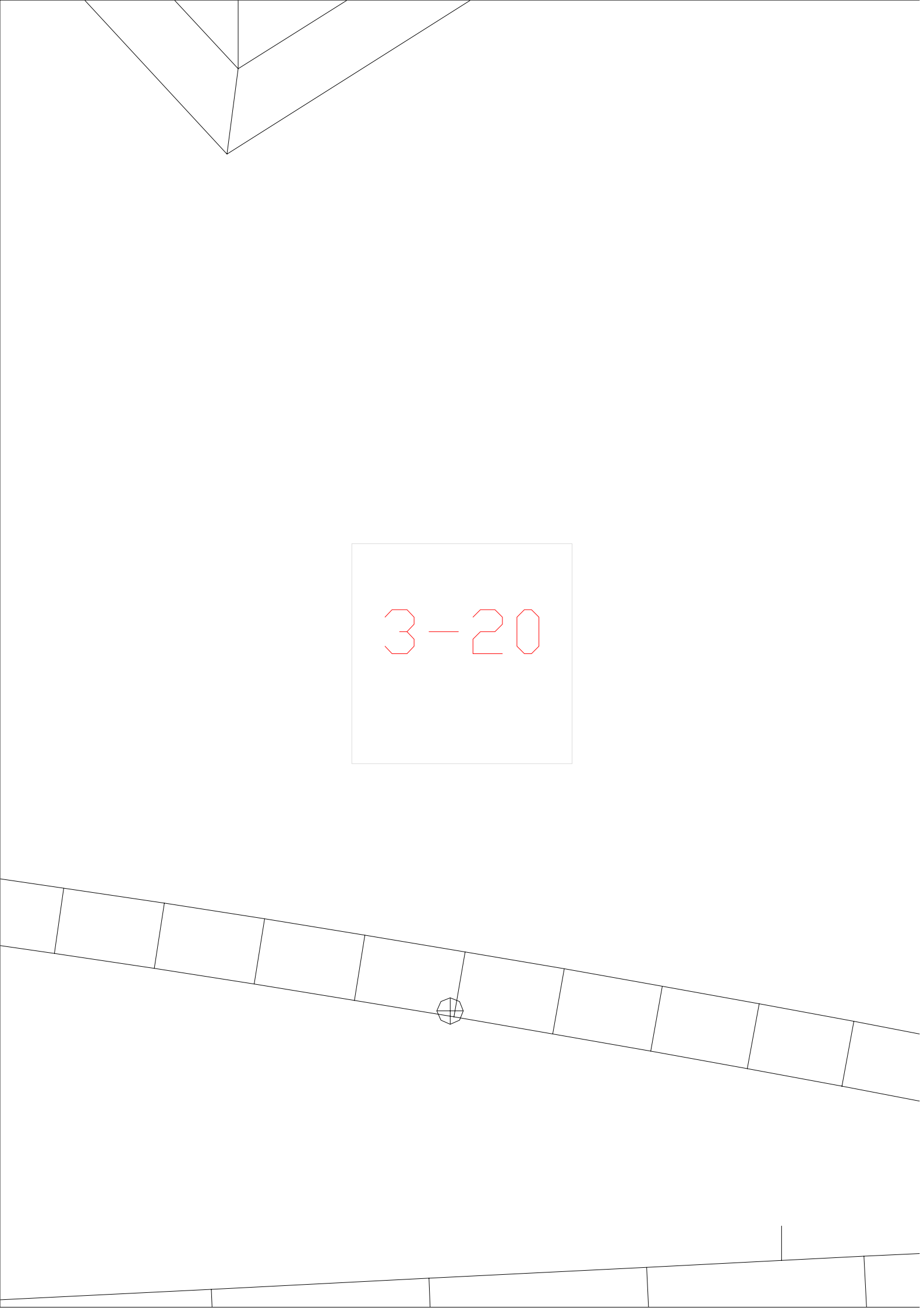

3-20

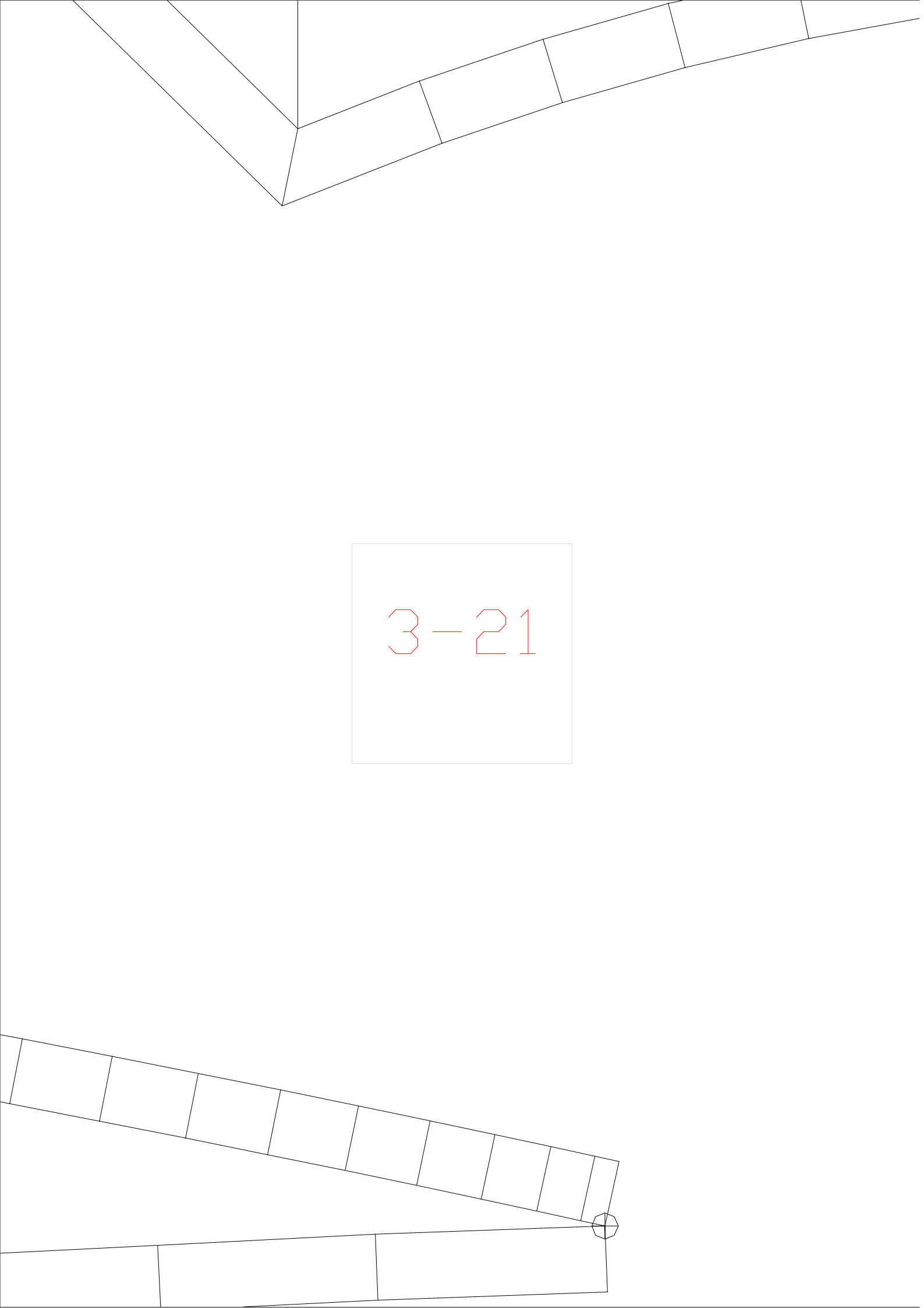

3-21

The image shows a technical drawing of a mechanical part, possibly a shaft or a component of a machine. The drawing is oriented vertically. At the top, there is a section of a shaft with a diameter that tapers to the right. This section is divided into several segments by vertical lines. Below this section is a large, empty rectangular area. In the center of this area, the text '3-21' is written in red. At the bottom, there is another section of a shaft, similar to the top section, but it is oriented horizontally and tapers downwards. This section is also divided into several segments. At the right end of this bottom section, there is a small circular feature, possibly a hole or a chamfered end.

3-22

3-23

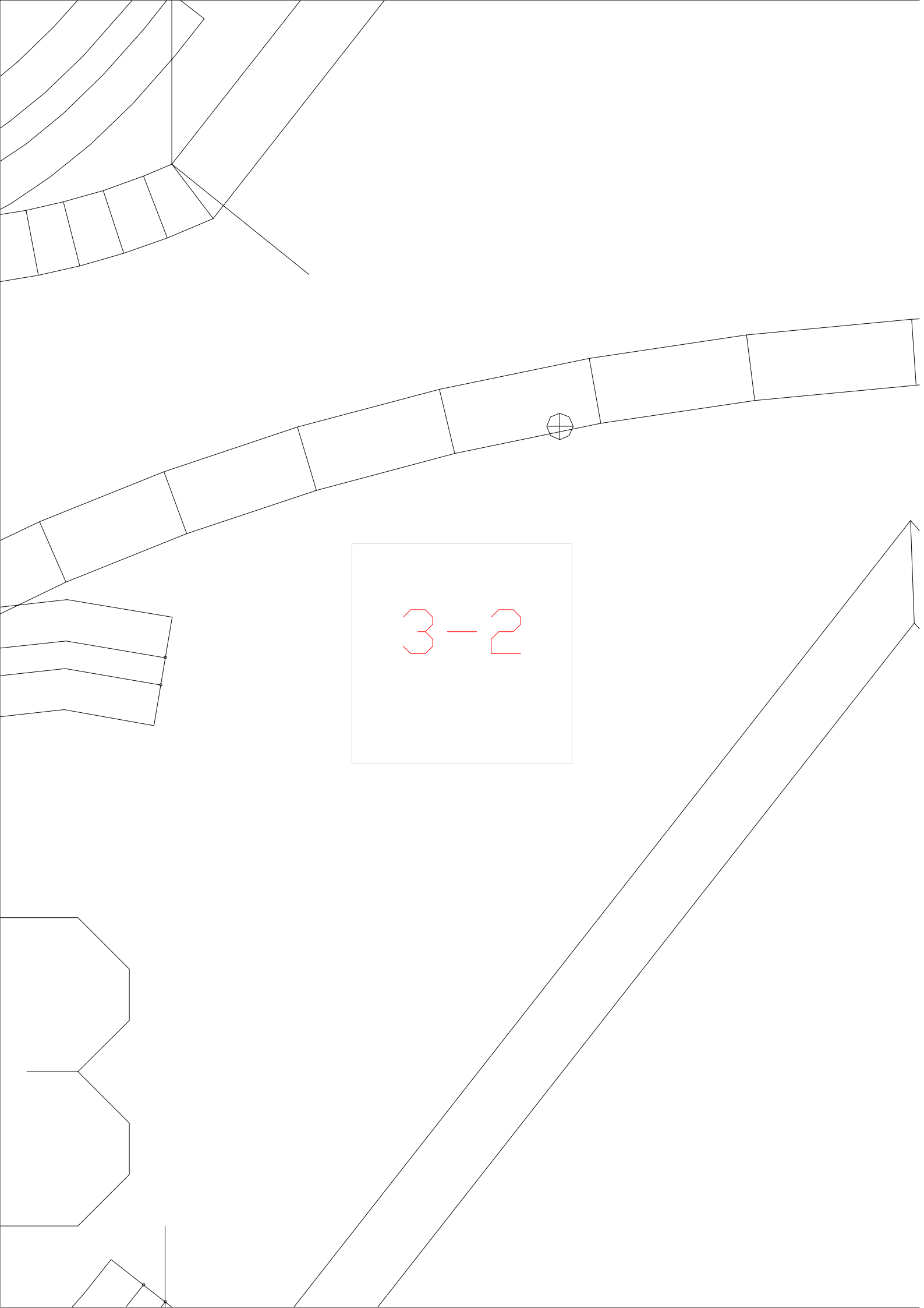

3-2

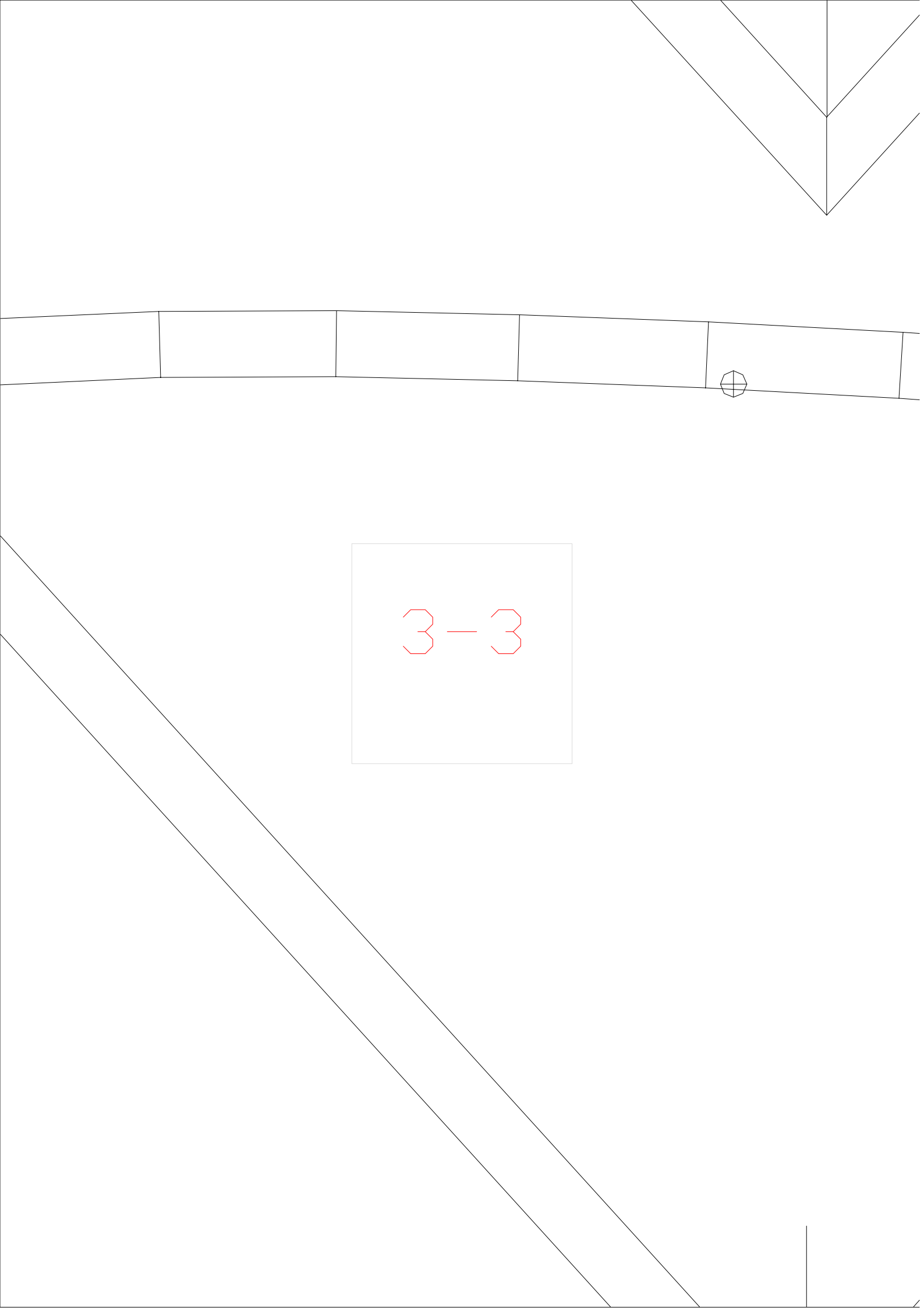

3-3

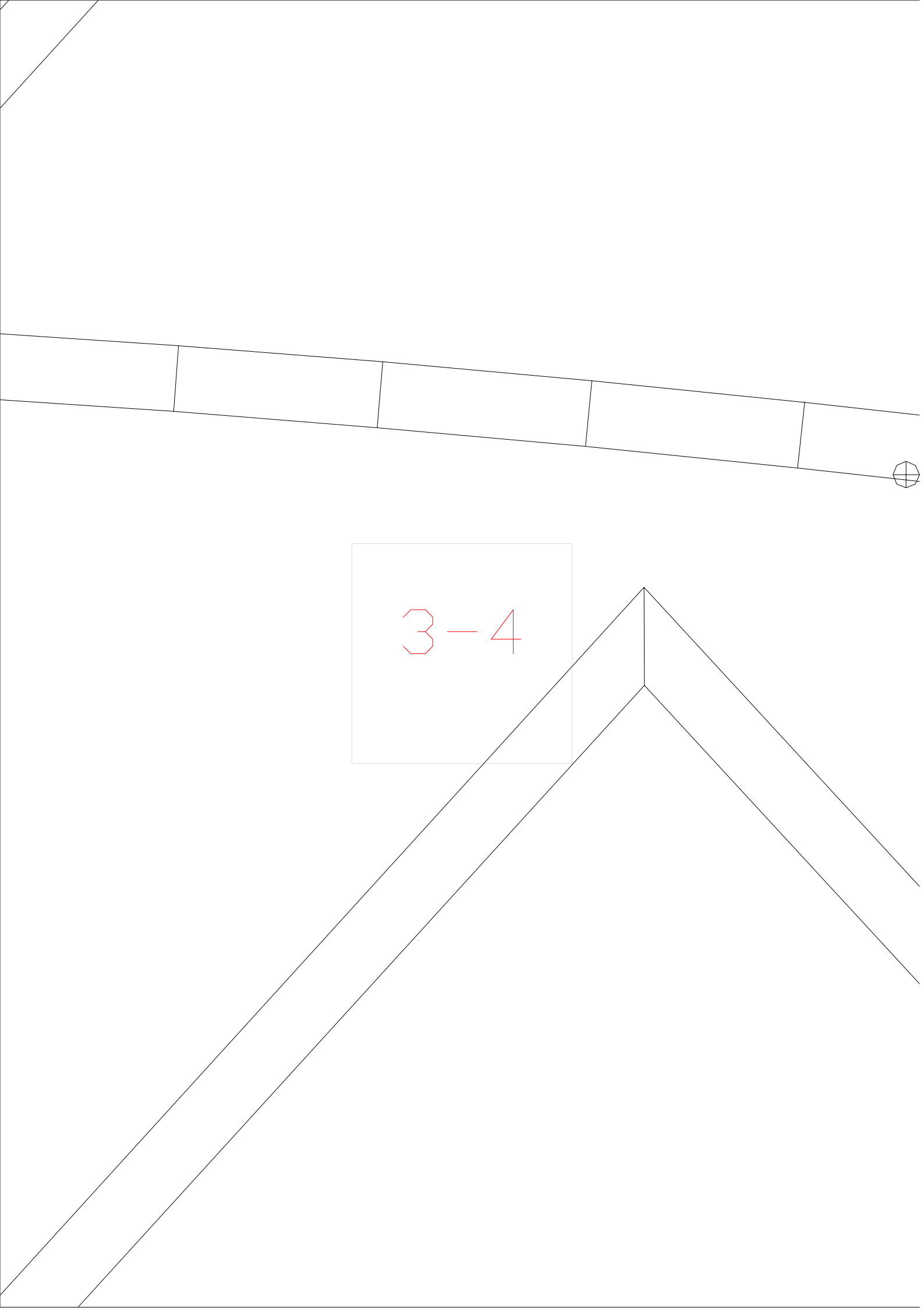

3-4

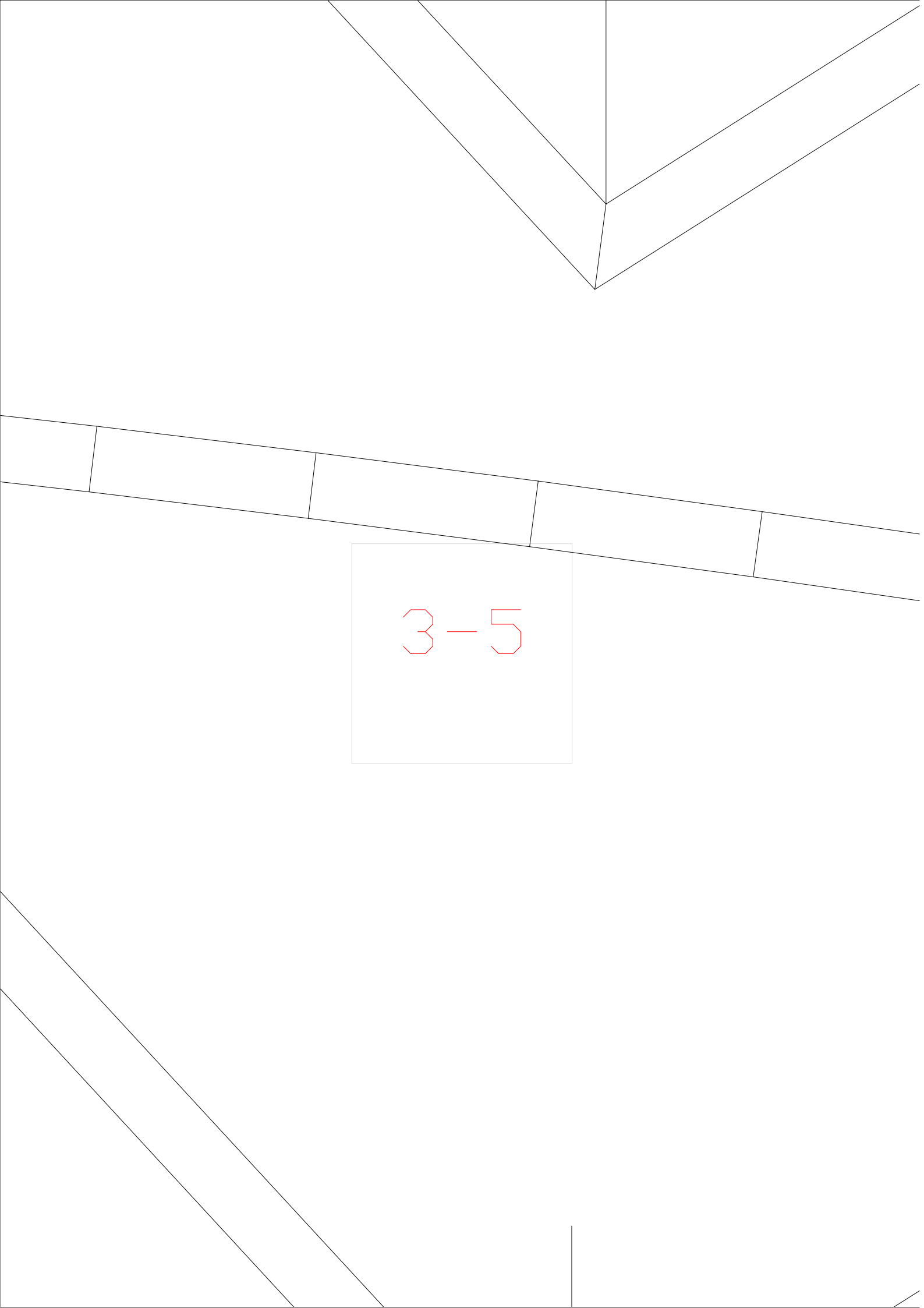

3-5

The image shows a technical drawing of a mechanical part, possibly a bracket or a support. It features a central rectangular callout box with a light blue border containing the red text '3-5'. The drawing includes several lines: a vertical line on the right side, a horizontal line at the top, a diagonal line from the top-left to the center, and another diagonal line from the top-right to the center. Below these, there is a horizontal line with four rectangular segments, and a diagonal line extending from the left side towards the bottom. The overall appearance is that of a schematic or a cross-section of a component.

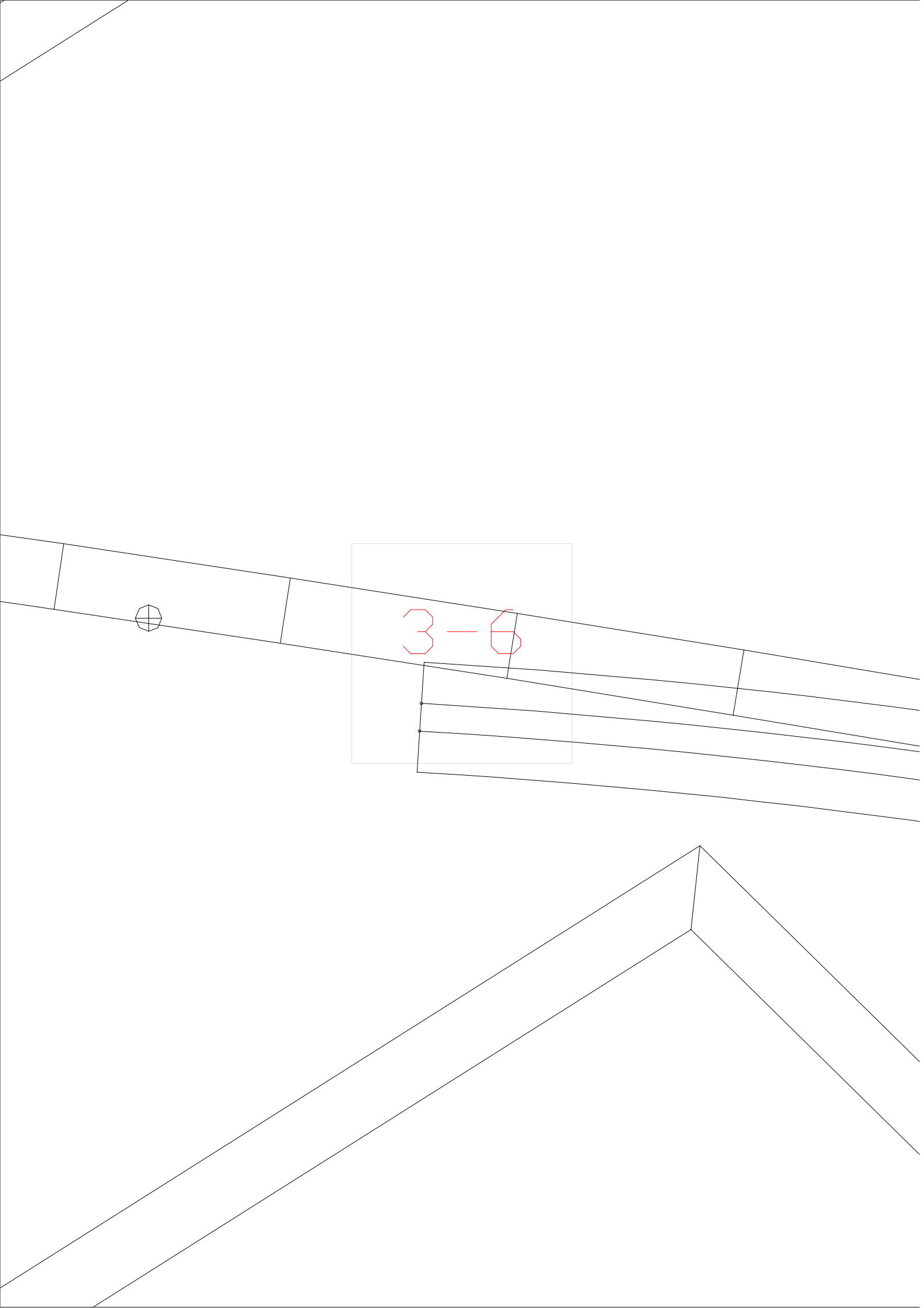

3-6



3-7

The image shows a technical drawing of a mechanical part, possibly a bracket or a support structure. The drawing is composed of several lines representing the geometry of the part. A central rectangular area is highlighted with a light gray background and contains the text '3-7' in red. The part has a complex shape with a vertical section on the right, a horizontal section at the top, and a long, angled section at the bottom. The angled section is divided into several segments by vertical lines. A small circular feature with a crosshair is located on the lower part of the angled section. The drawing is a line drawing with no shading or color, except for the red text and the gray highlight.

3-8



3-9

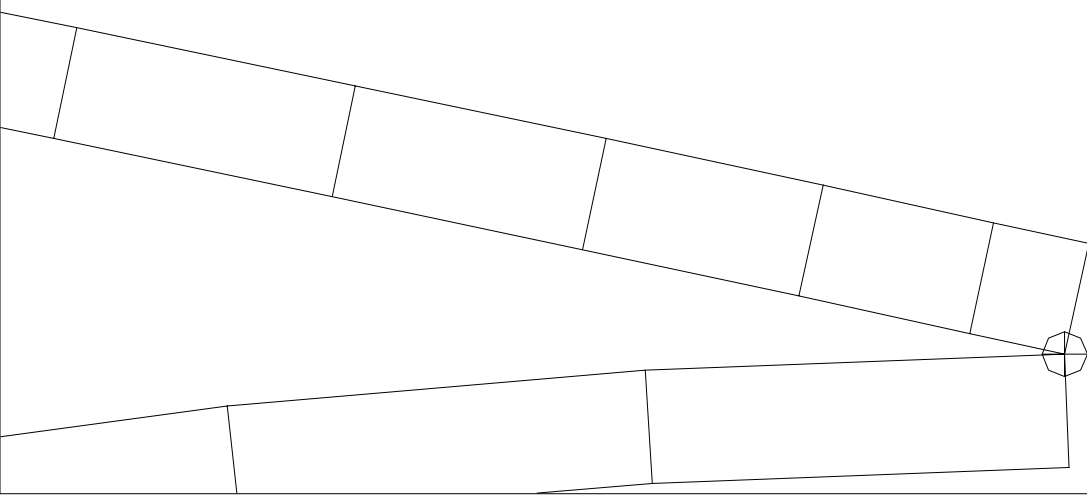

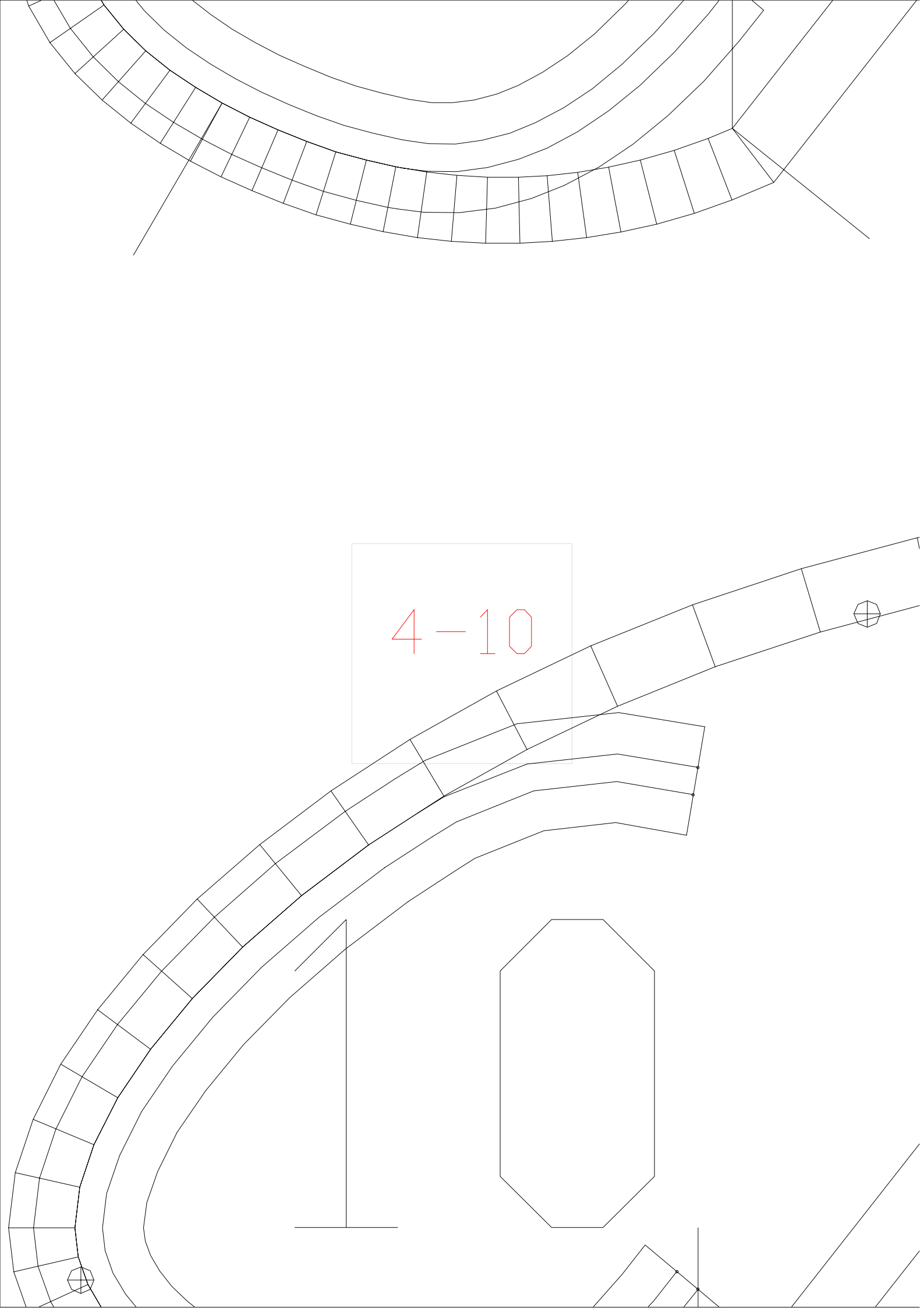

4-10

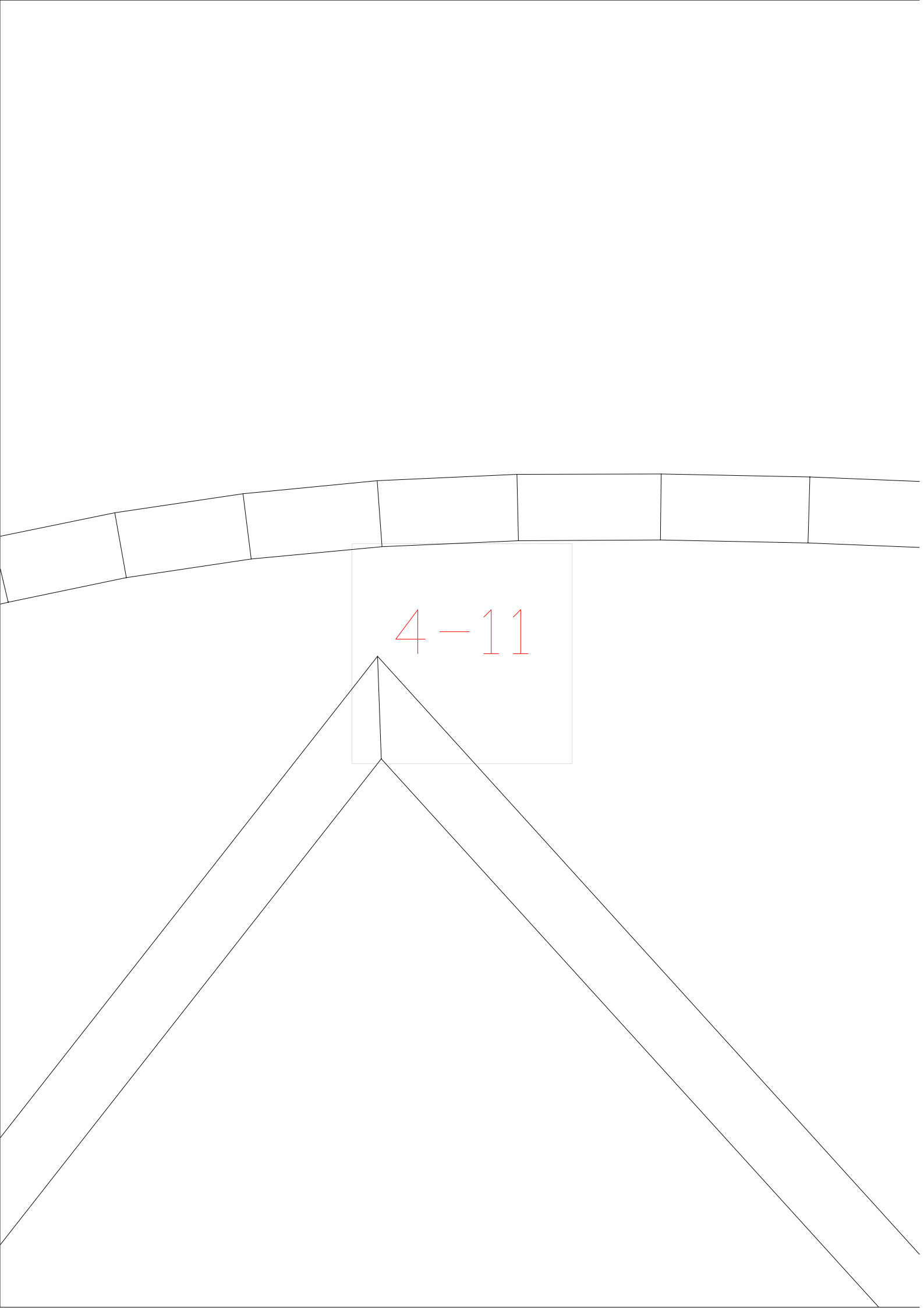

4-11

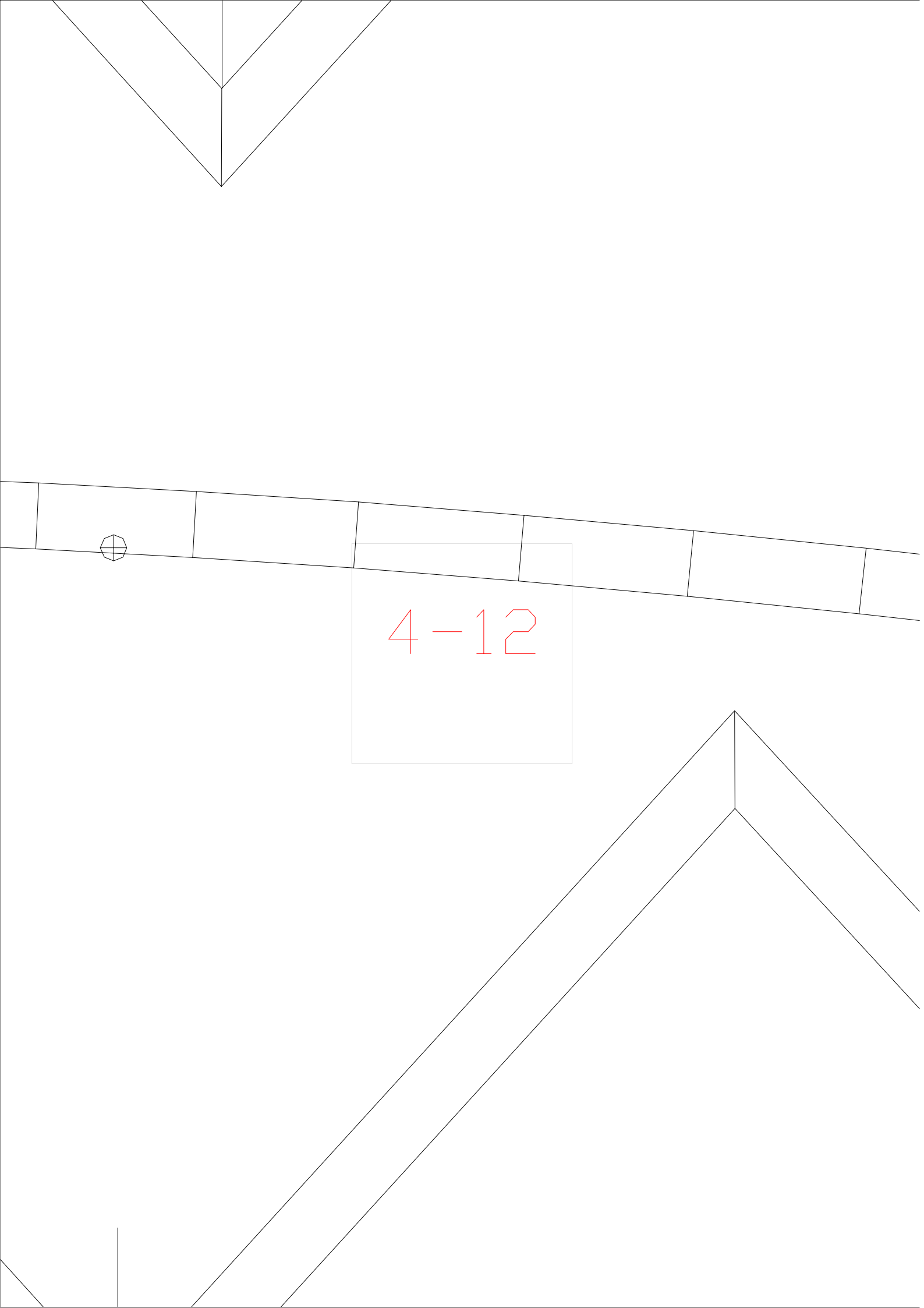

4-12

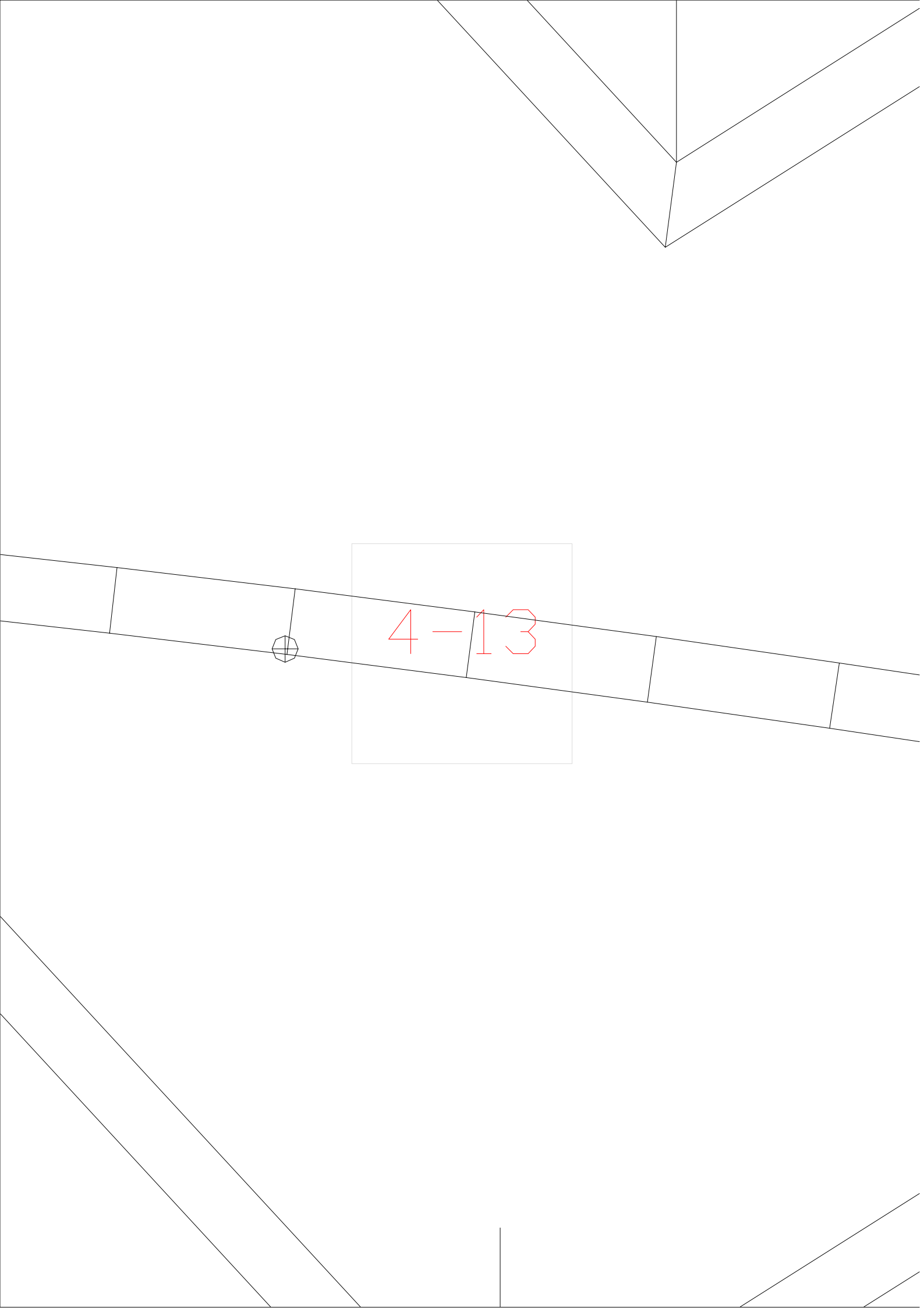

4-13

4-14

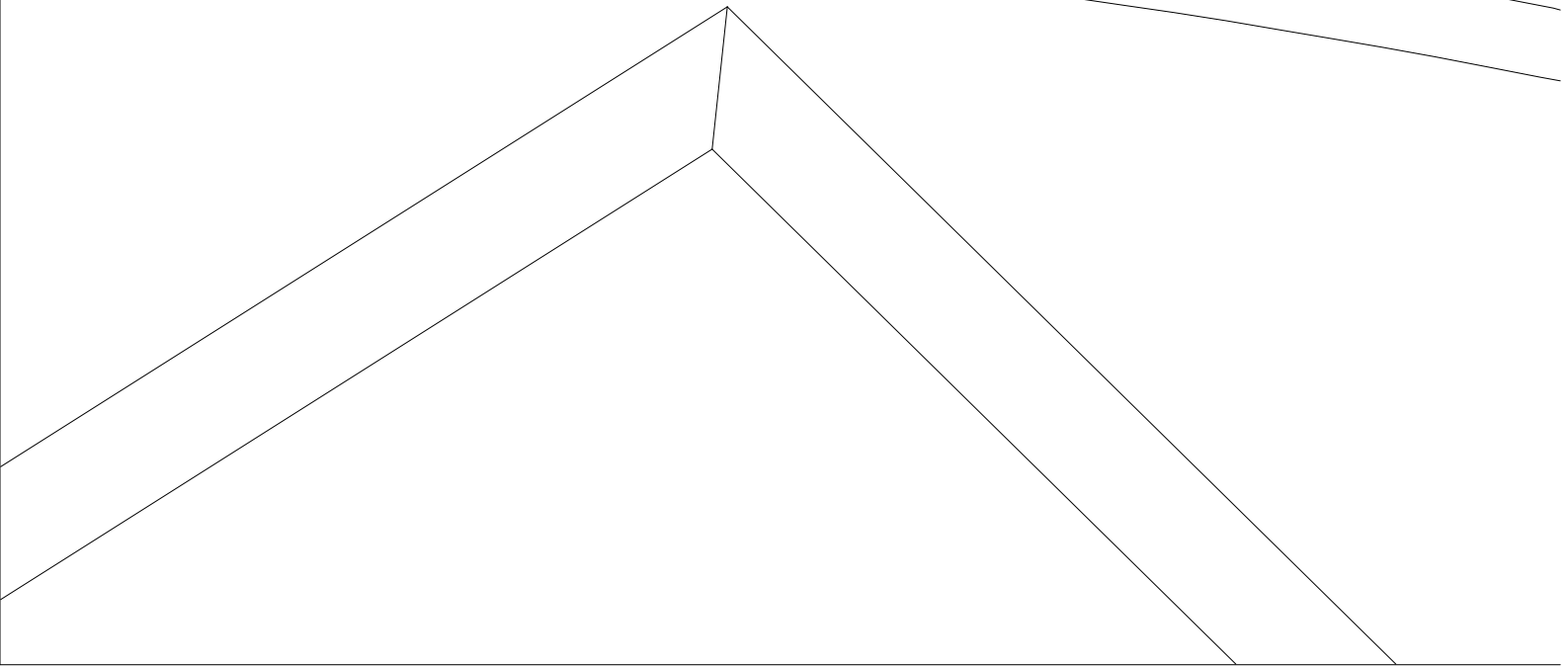
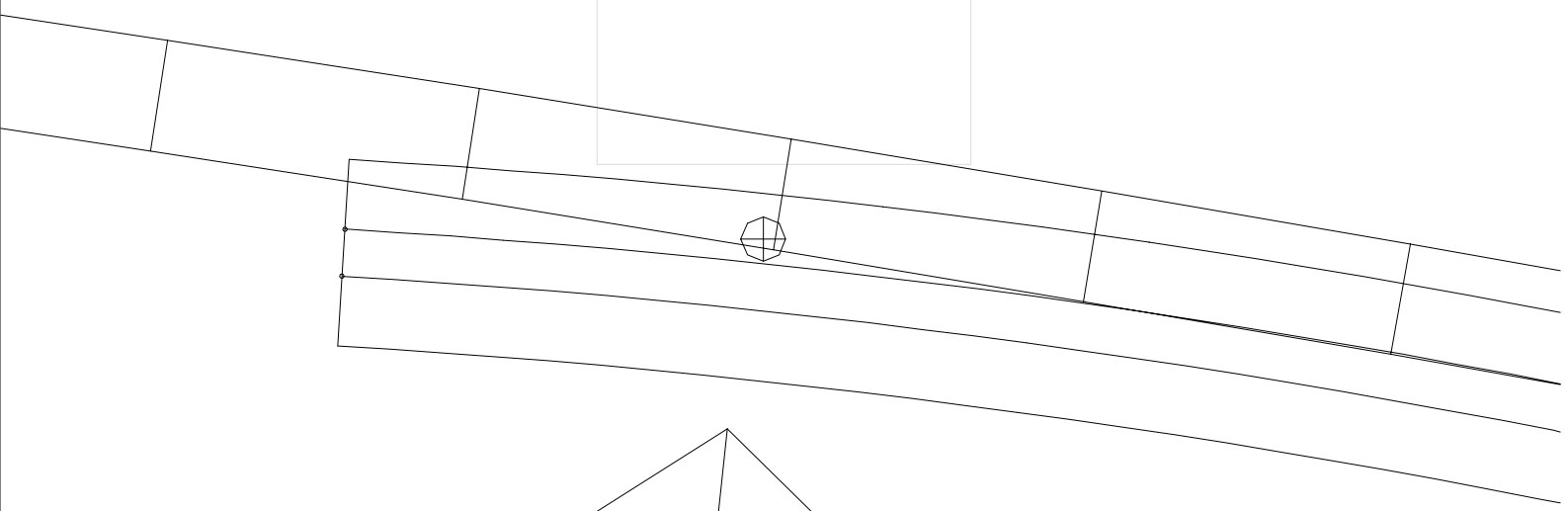

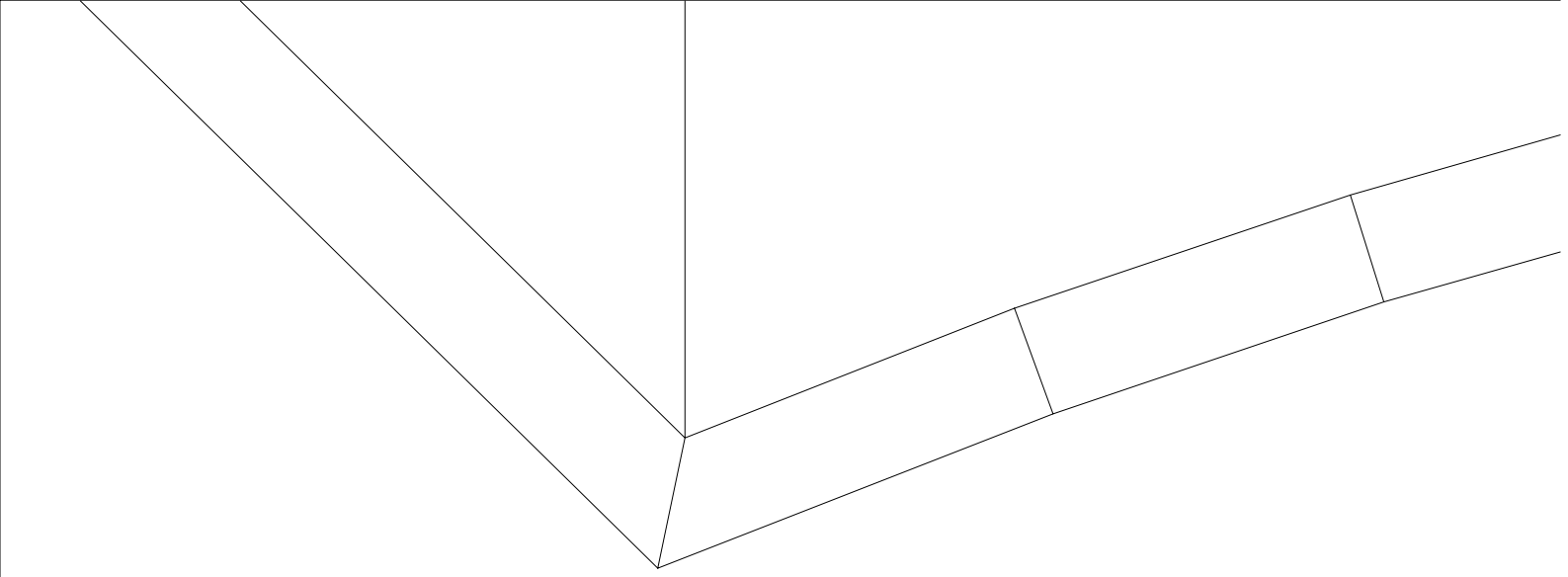

4-15

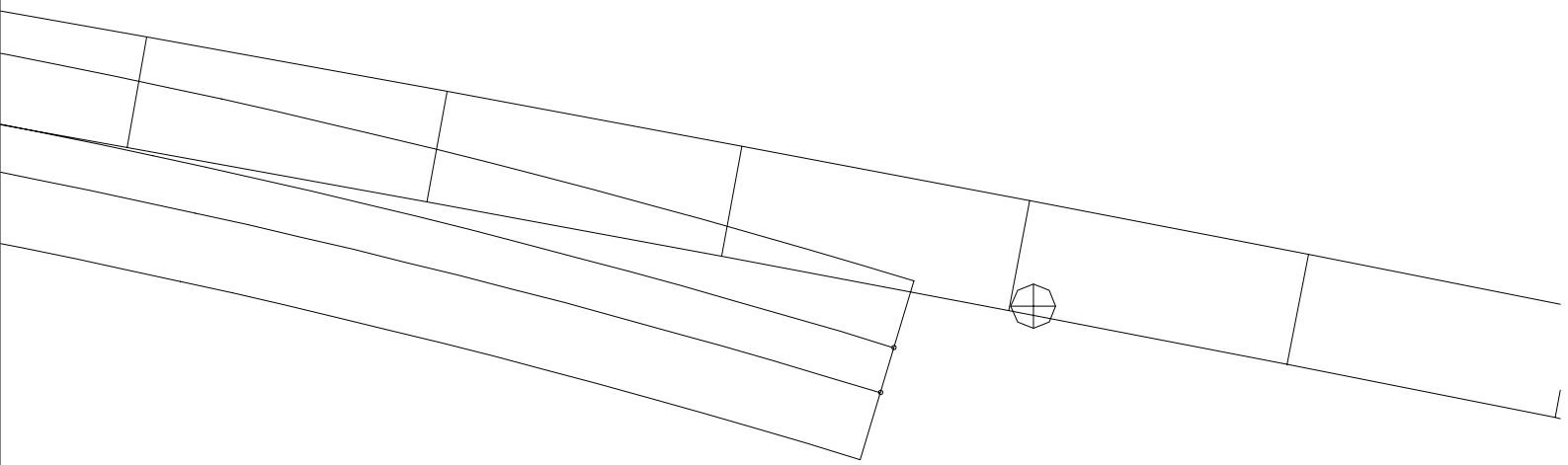

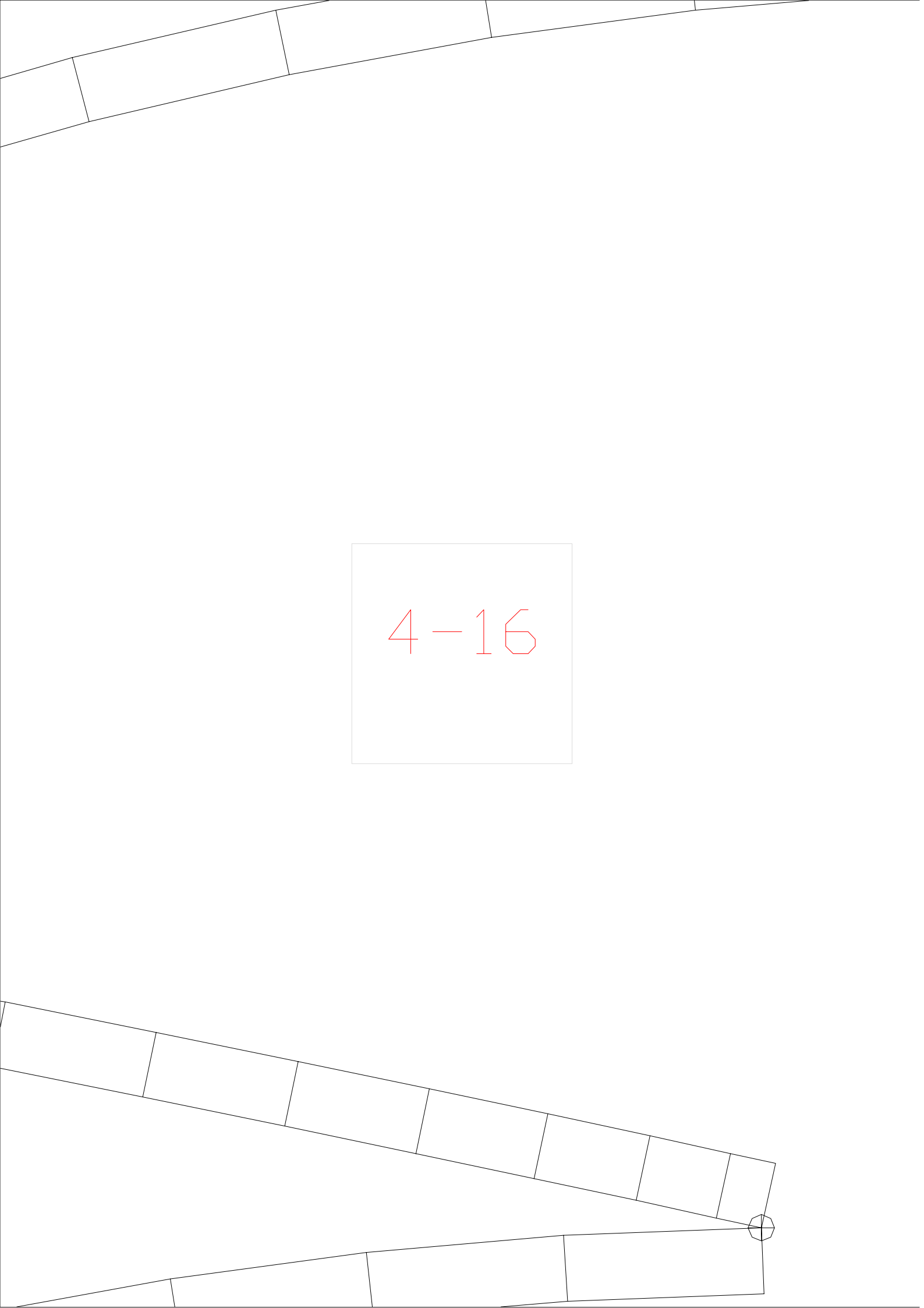

4-16

4-17

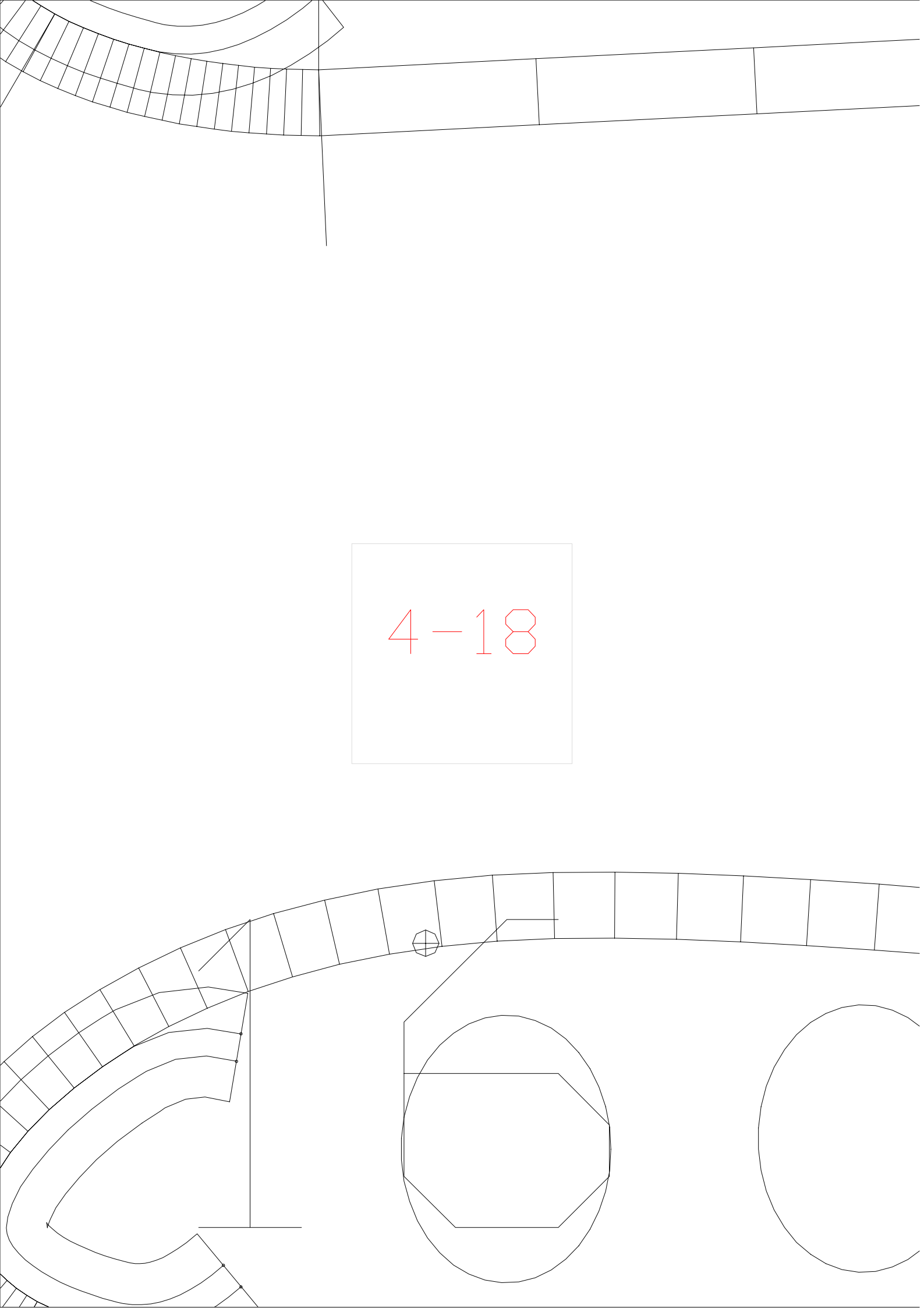

4-18

4-19

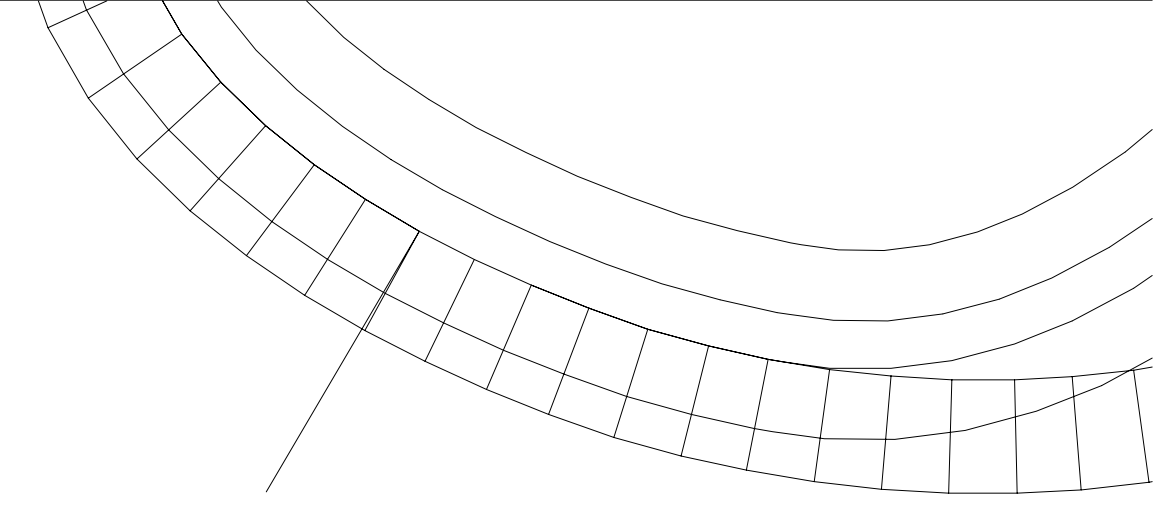

4-1

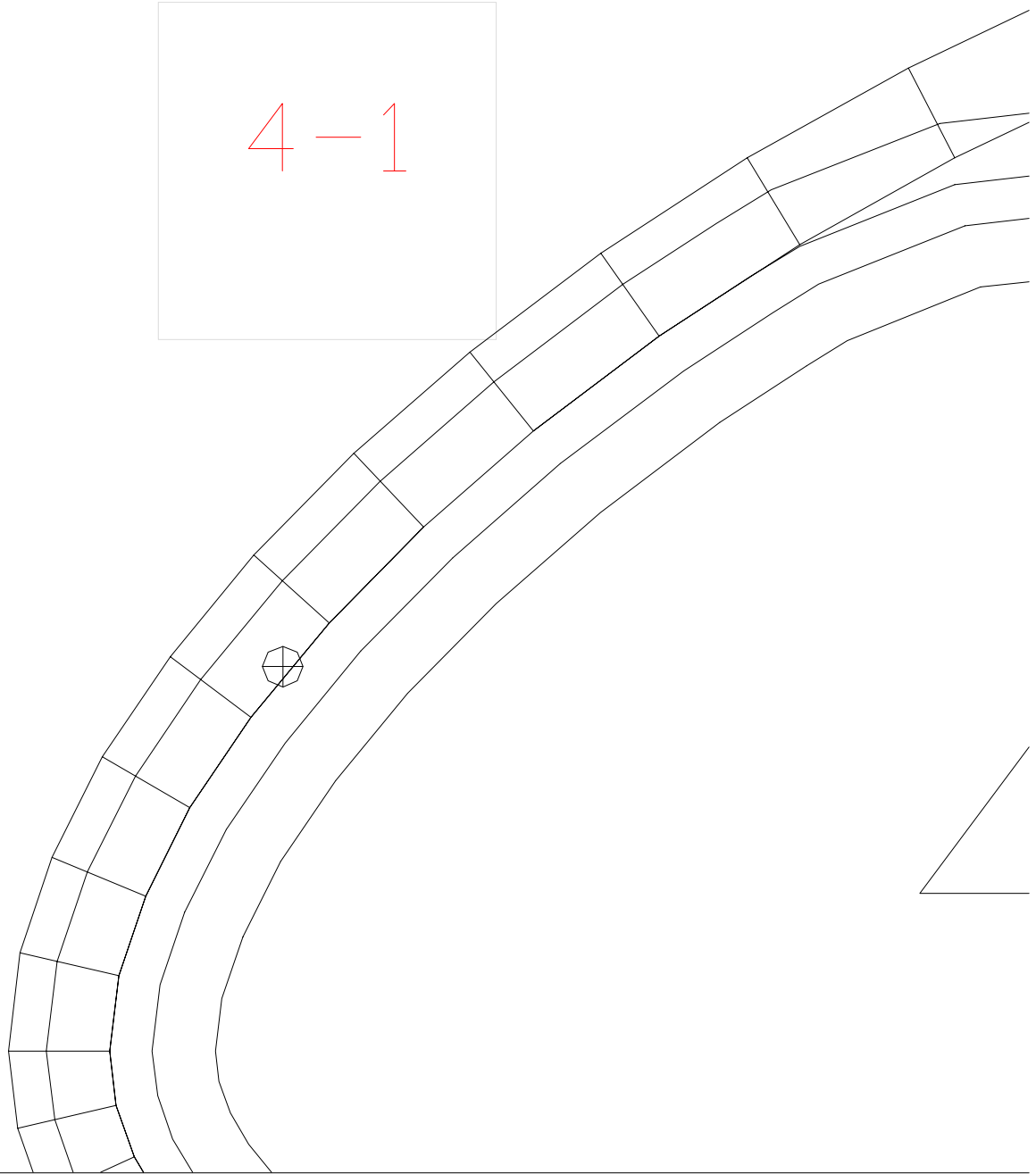

4-20

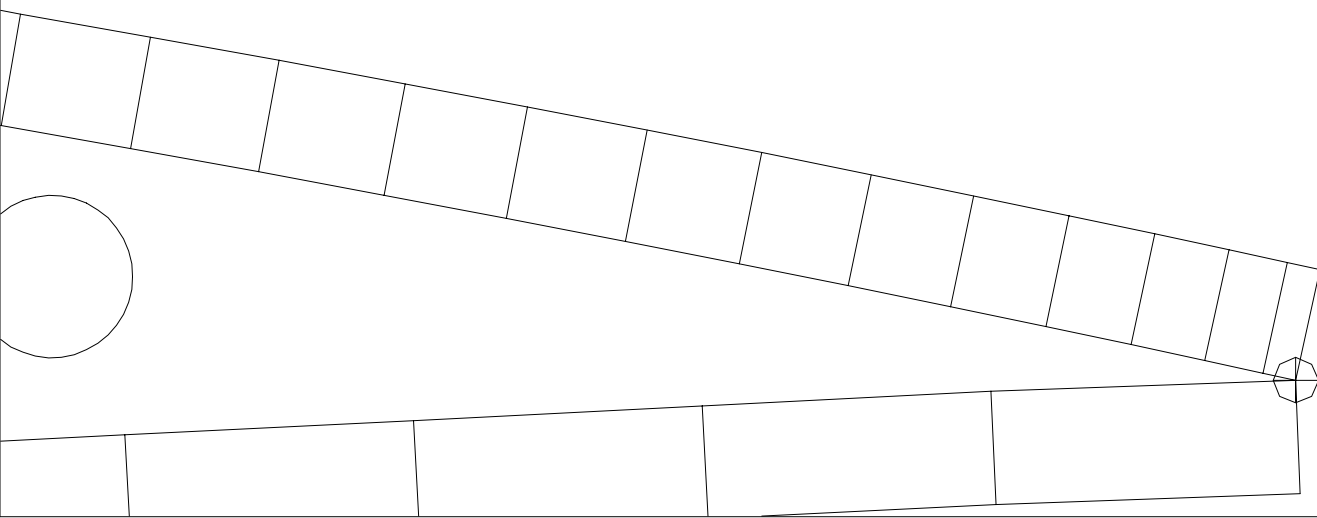

4-21

4-22

4-23

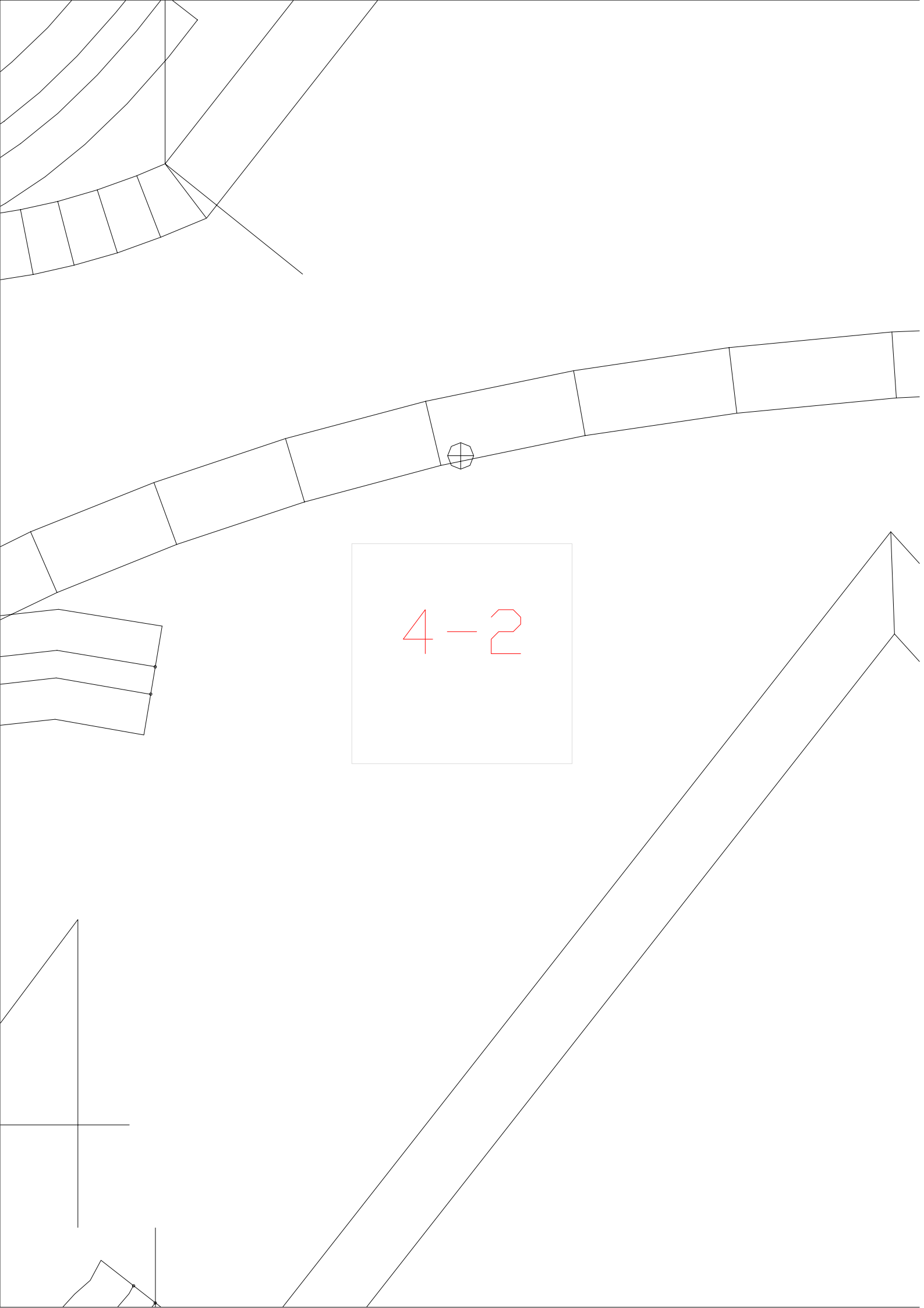

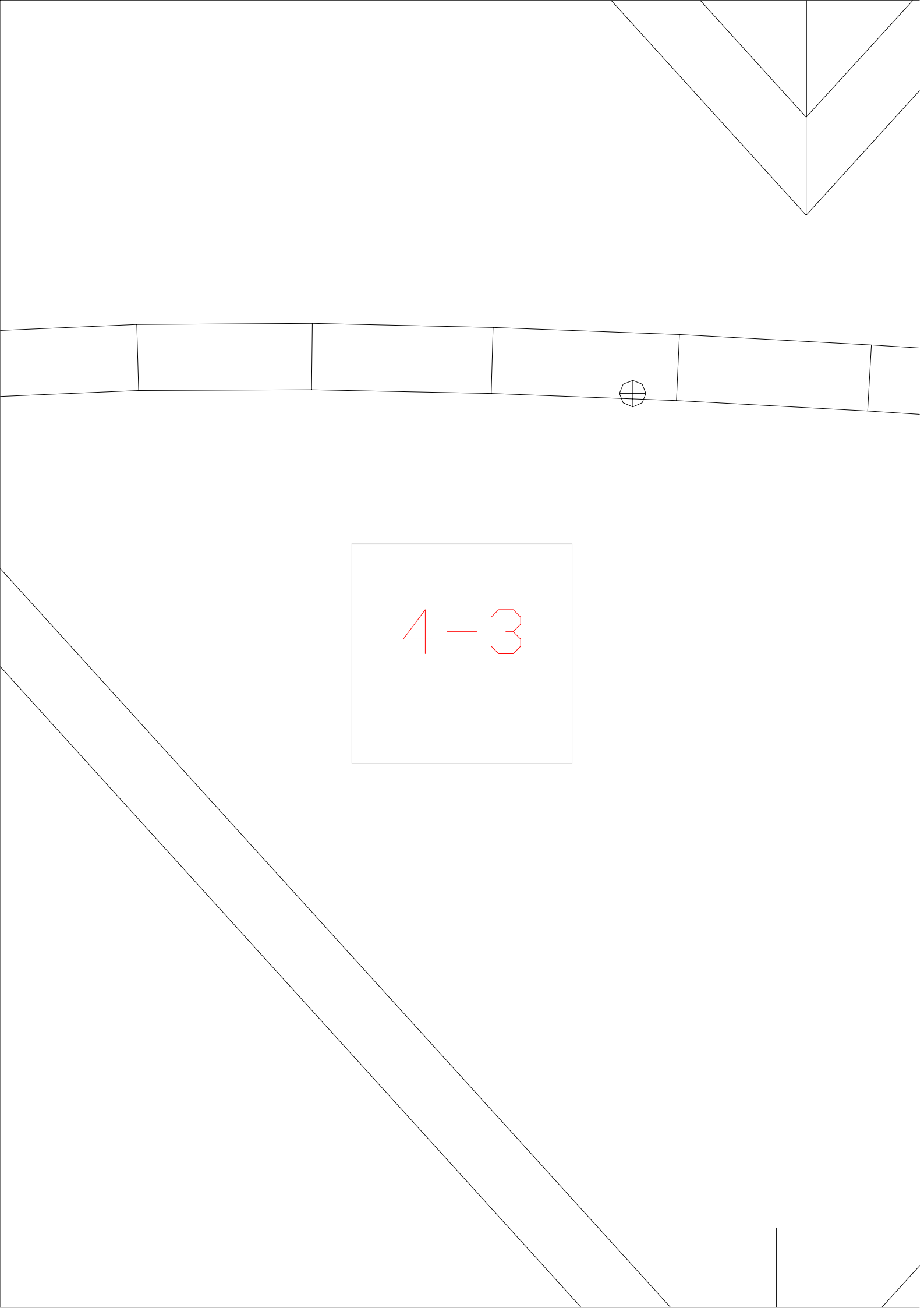

4-3

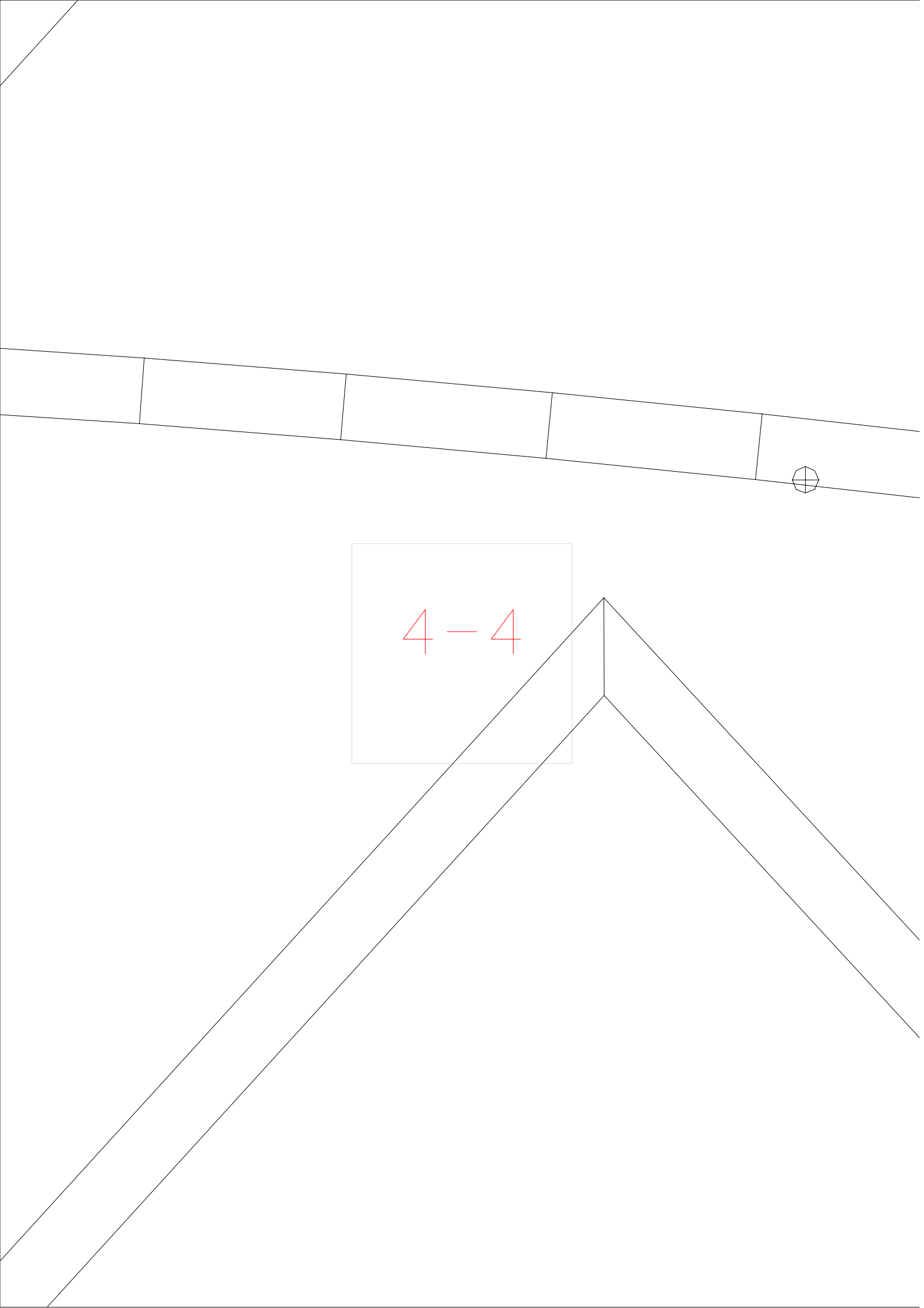

4-4

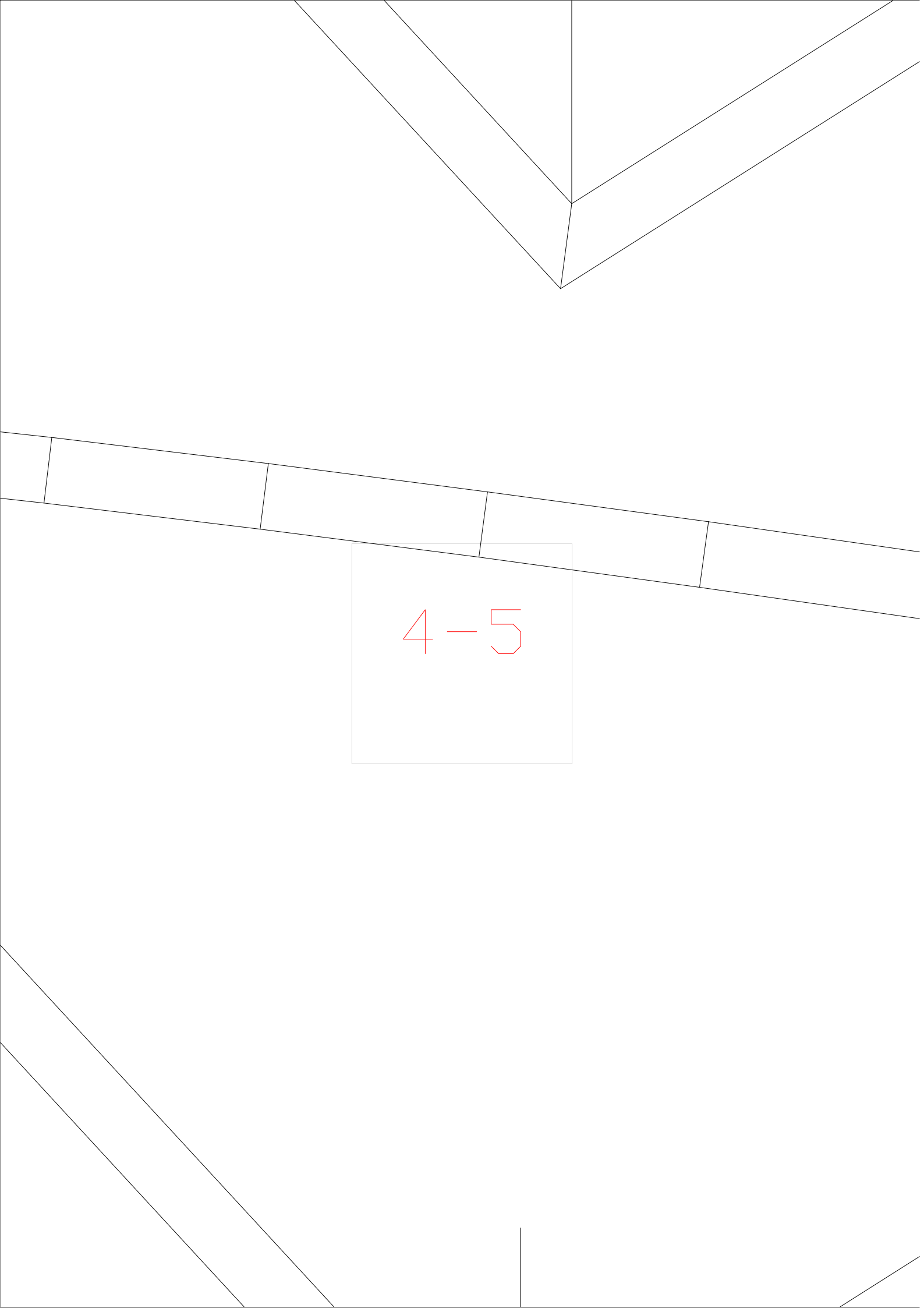

The image shows a technical drawing of a mechanical part, possibly a shaft or a similar cylindrical component, with a complex, multi-faceted geometry. The drawing is composed of several lines representing the edges and surfaces of the part. A specific section of the part is highlighted with a red rectangular box, and the text "4-5" is written in red within this box, indicating a cross-section or a specific view of the part. The drawing is oriented vertically, with the top of the part at the top of the image and the bottom at the bottom. The lines are black, and the background is white.

4-5

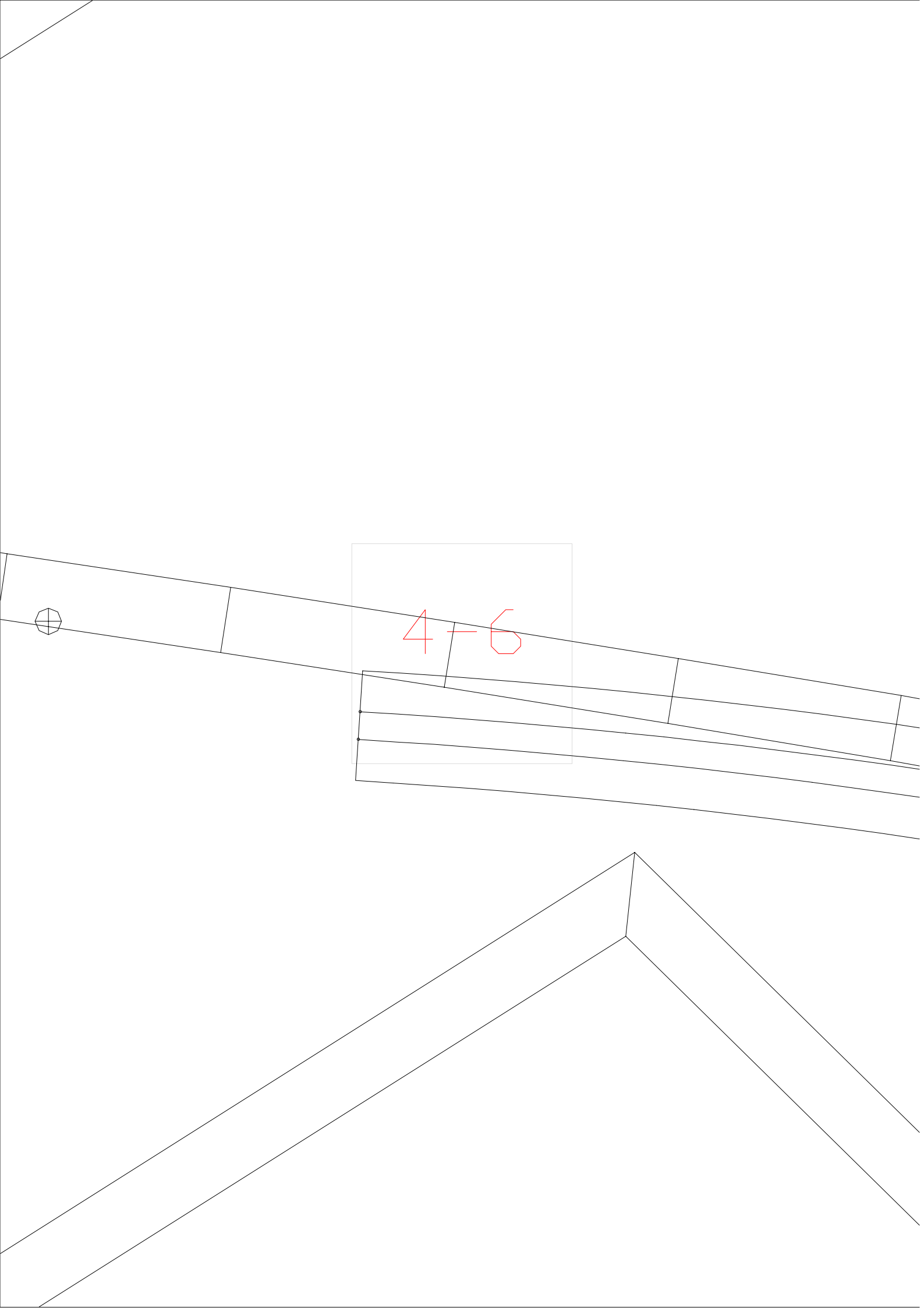

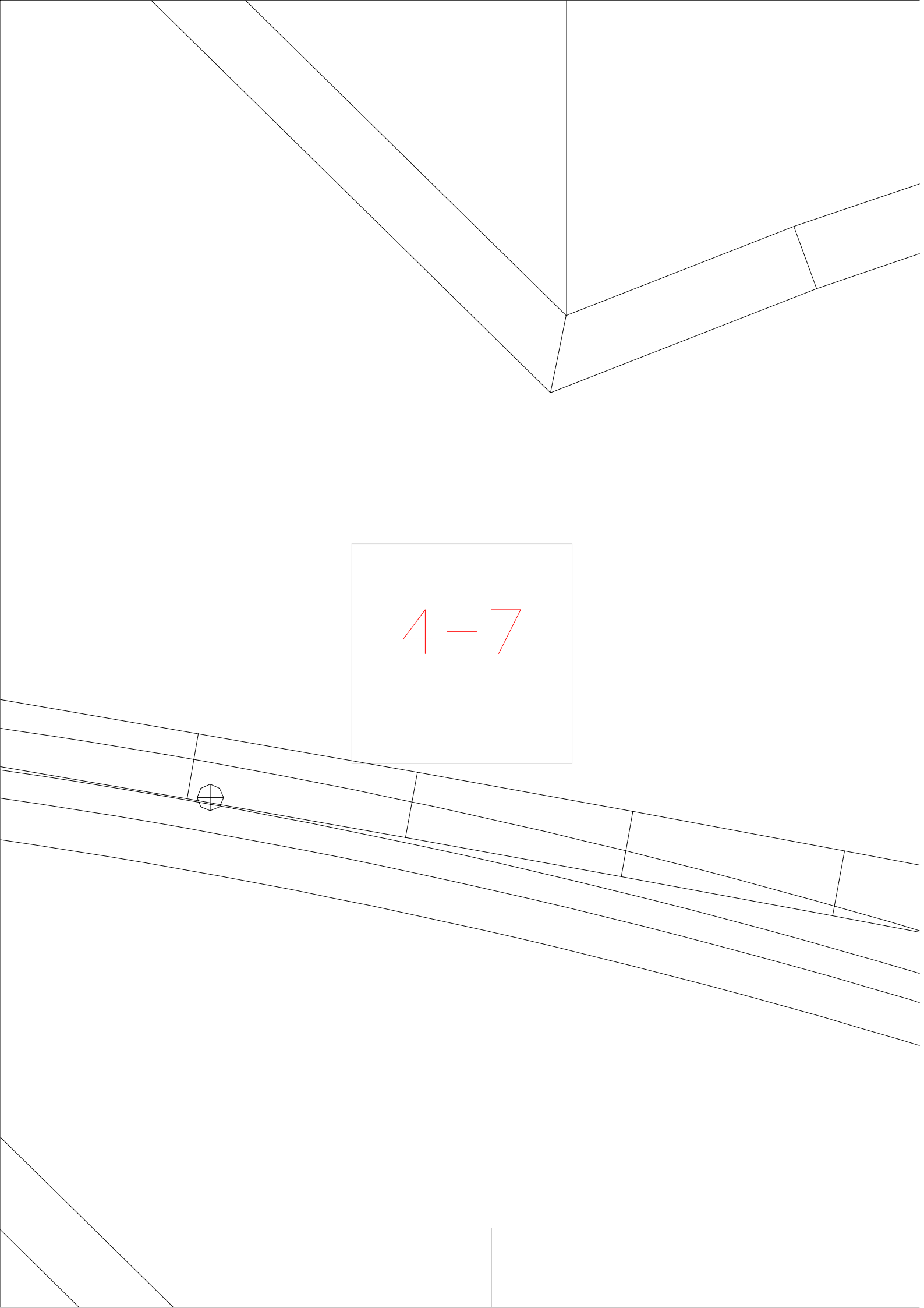

4-7

The image is a technical drawing of a roof structure. It features a central gable roof with a vertical ridge line. Below the roof, there are several horizontal lines representing a sloped roof surface or a series of parallel structural elements. A rectangular area is highlighted in light green, containing the red text '4-7'. To the left of this area, there is a small octagonal symbol with a cross inside, possibly representing a specific detail or a section marker. The drawing is composed of black lines on a white background.

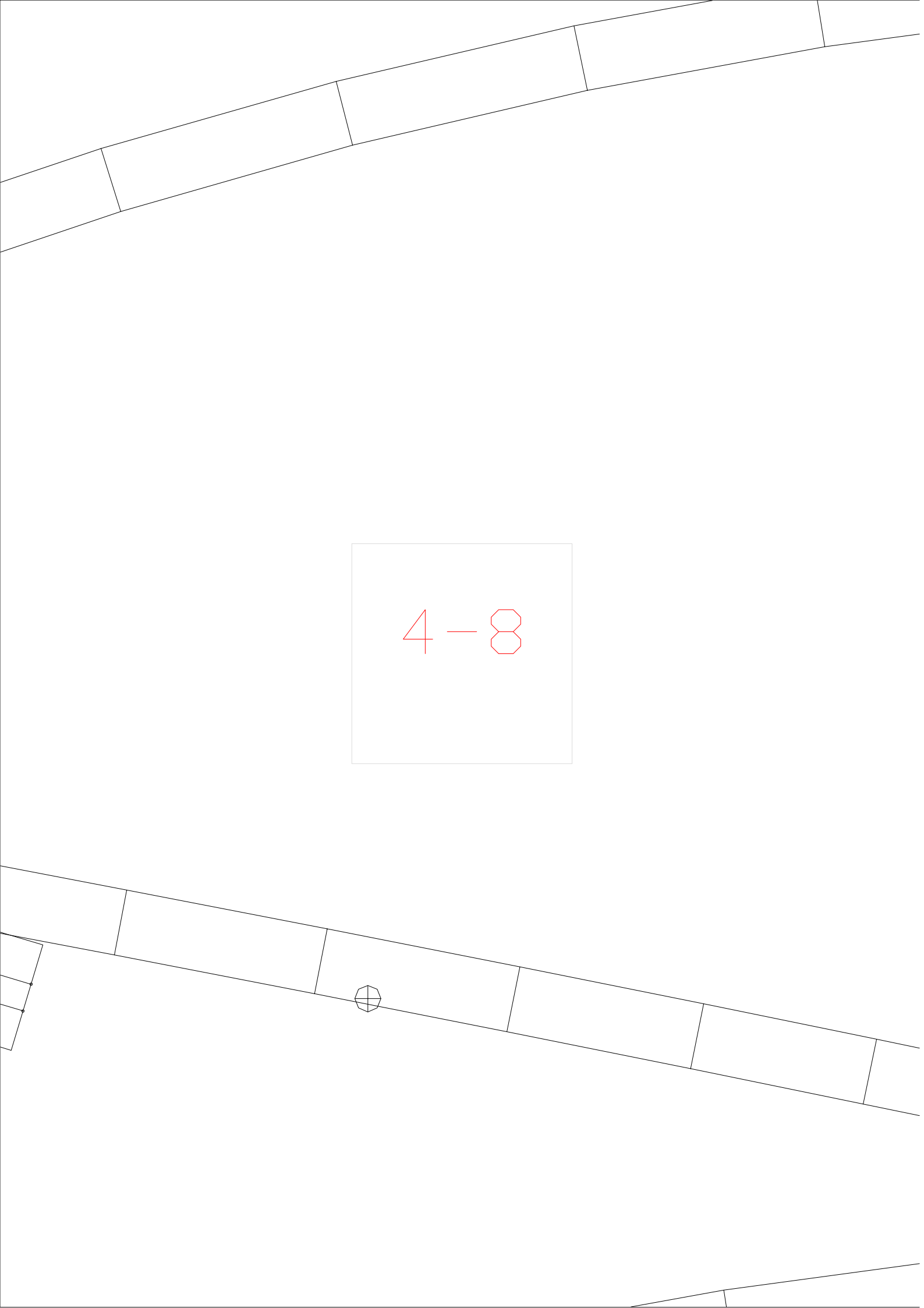

4-8

4-9

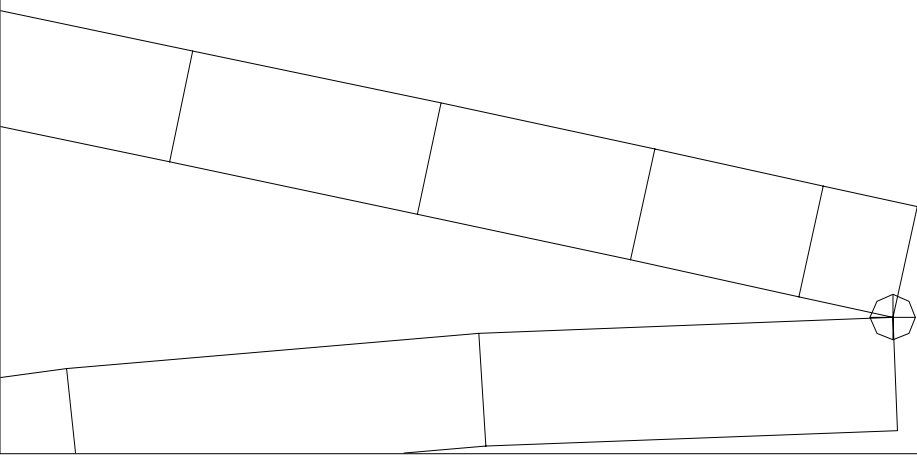

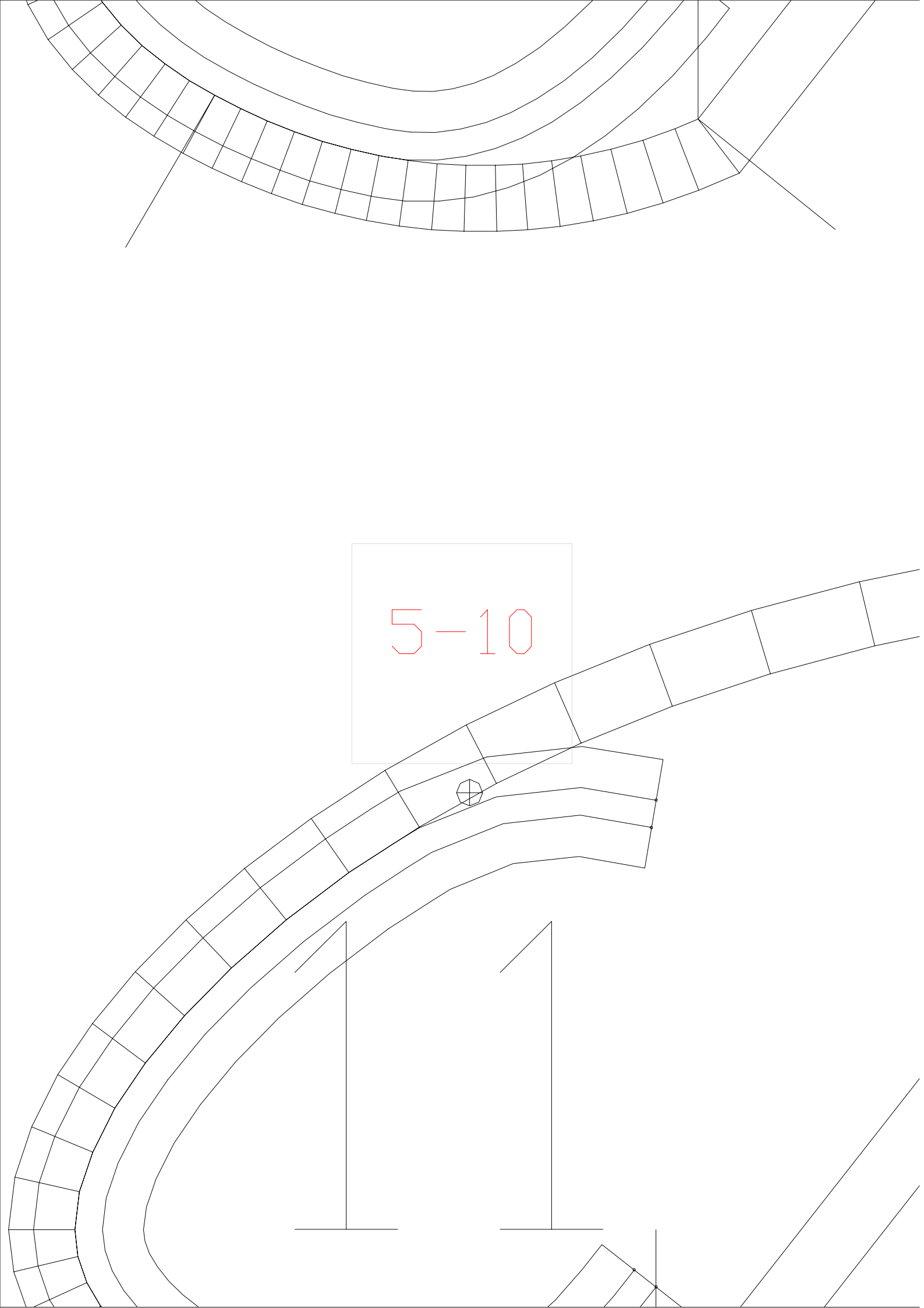

5-10

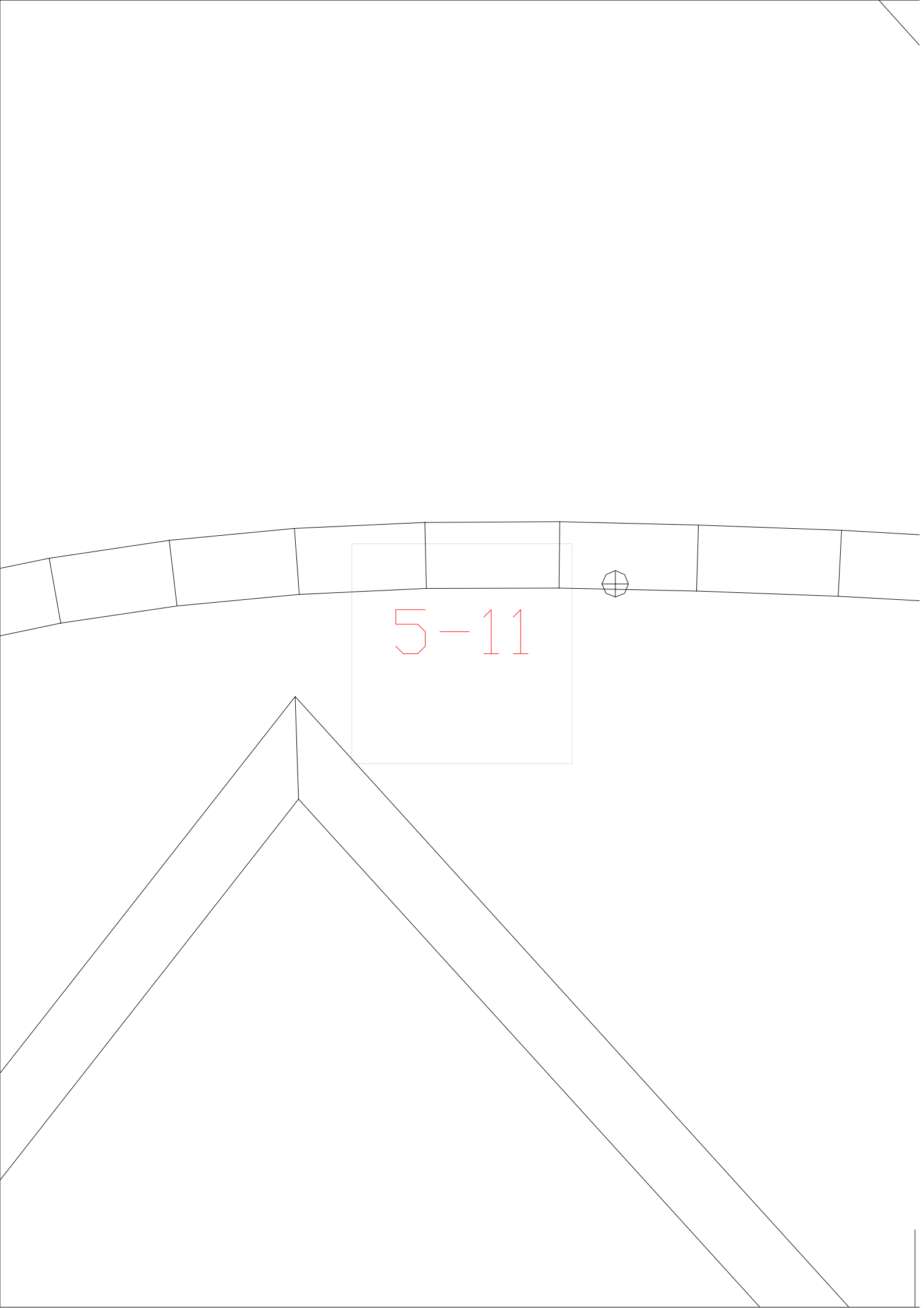

5-11

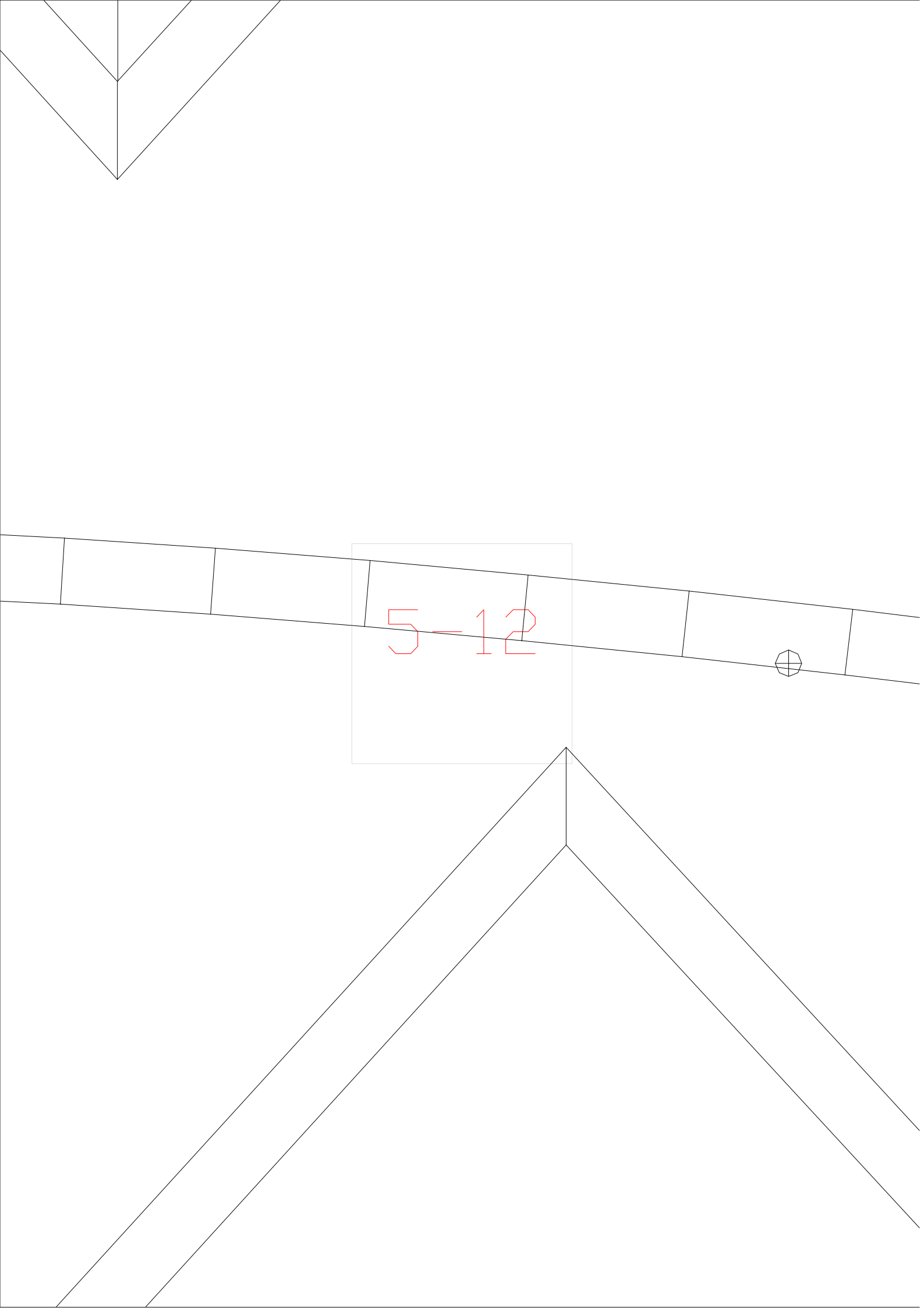

5-12



5-13

The image shows a technical drawing of a mechanical part. At the top, there is a V-shaped feature with a central vertical line. Below this, a horizontal line is divided into several segments by vertical lines. A central rectangular area is highlighted with a light gray border and contains the red text '5-13'. To the right of the main horizontal line, there is a small rectangular detail with three horizontal lines inside. At the bottom, there are several diagonal lines forming a trapezoidal shape.

5-14

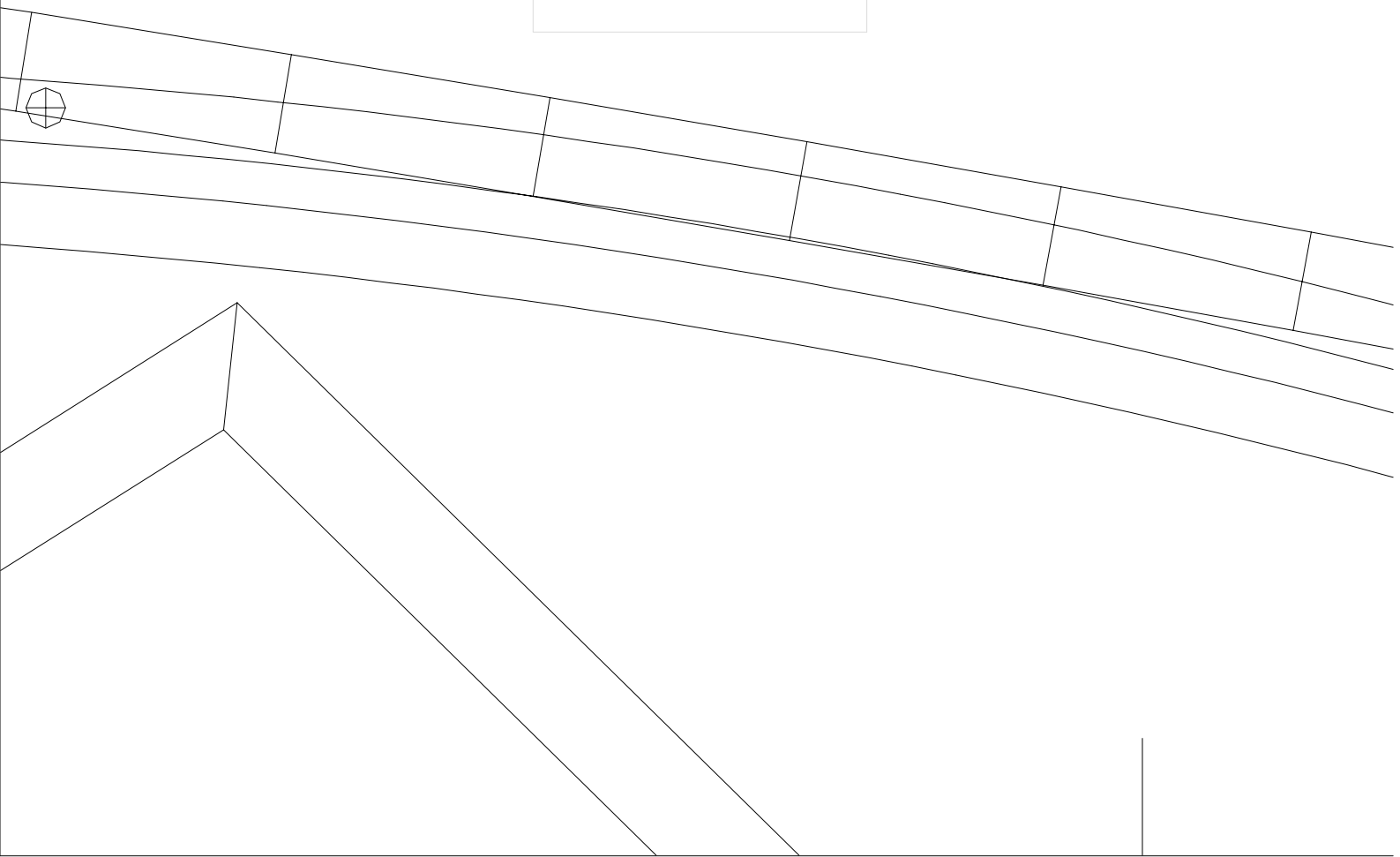

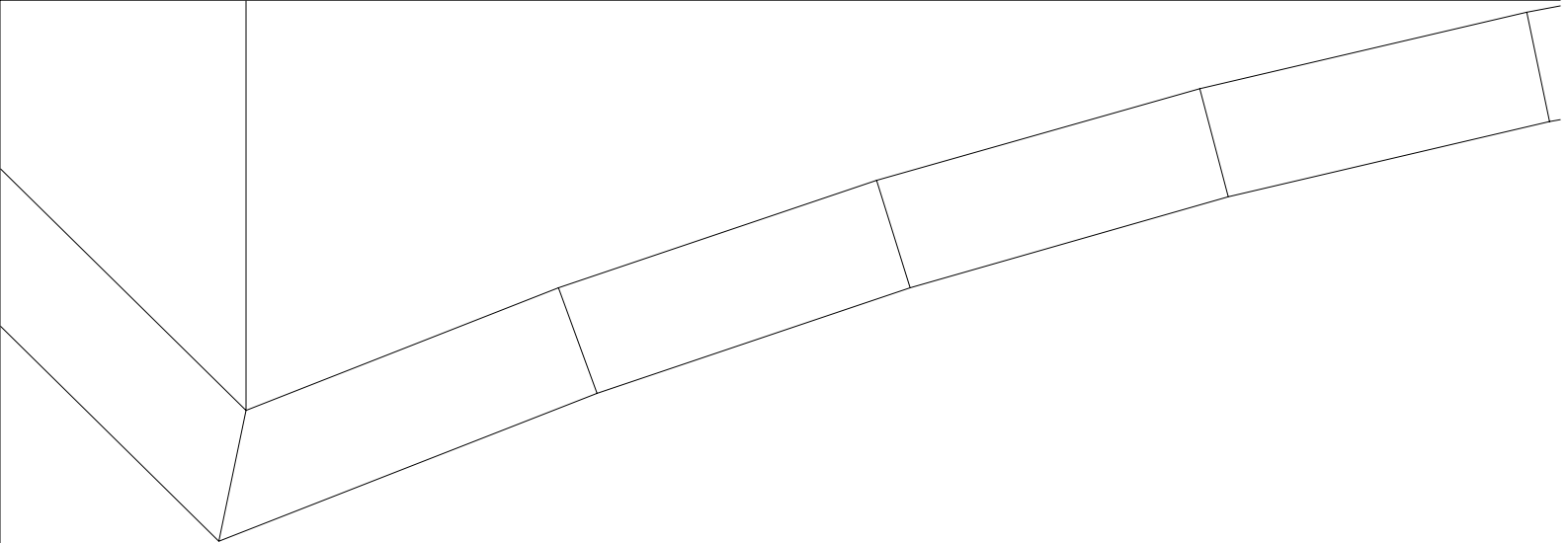

5-15

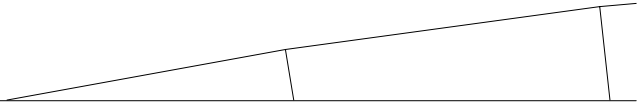
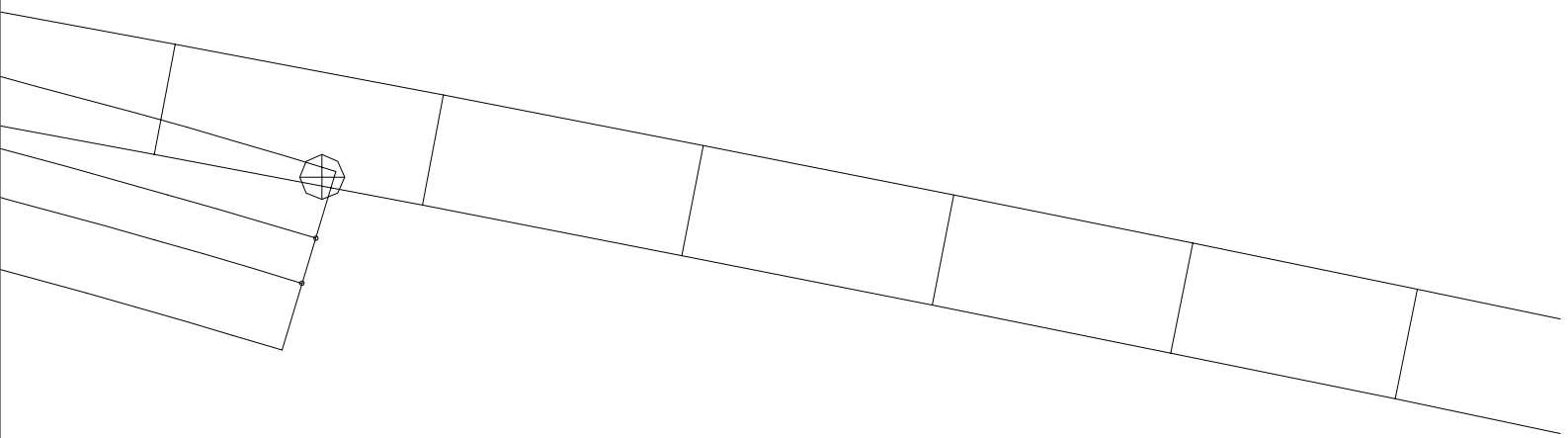

5-16

5-17

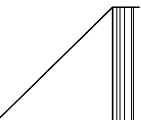

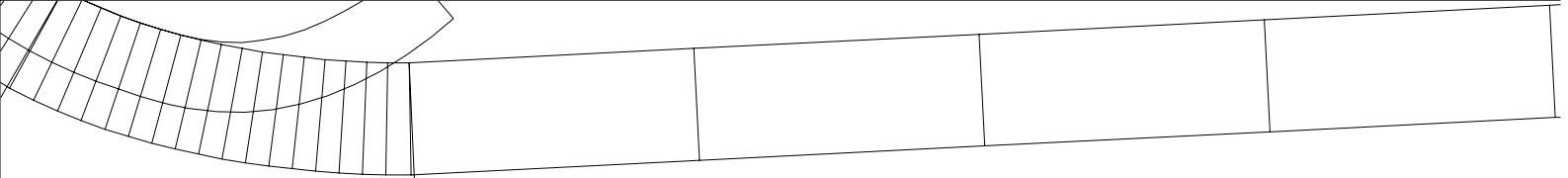

5-18

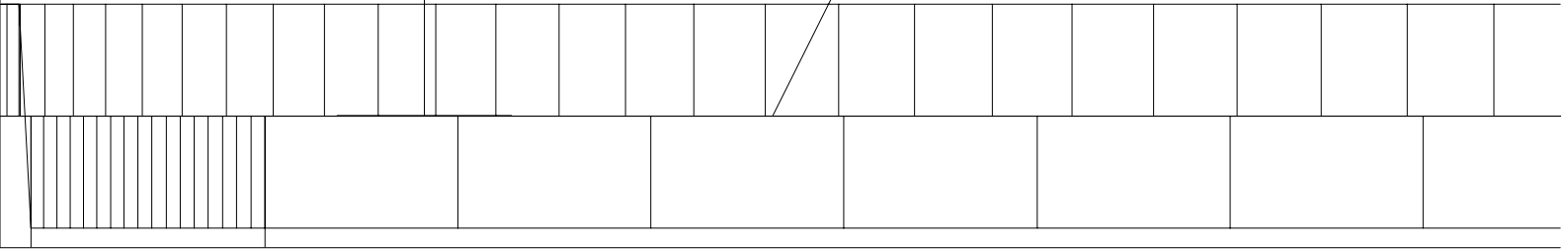
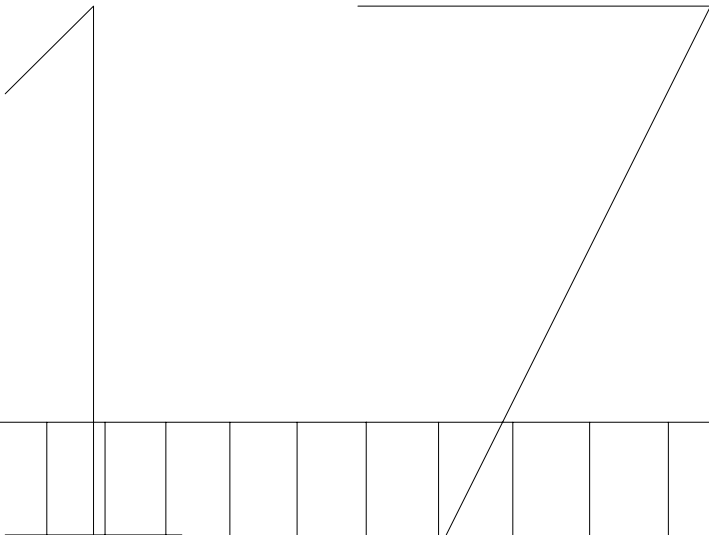

5-19

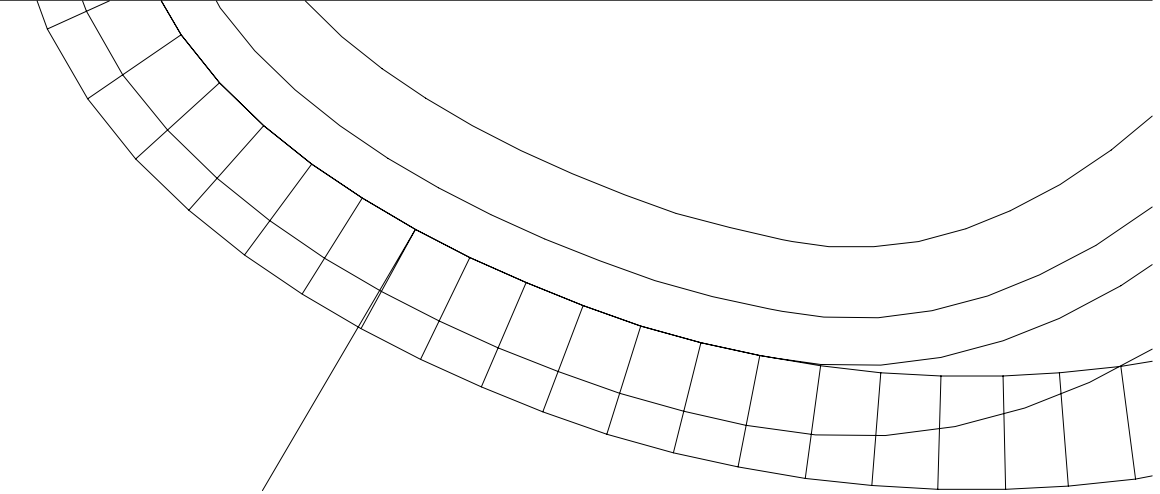

5-1

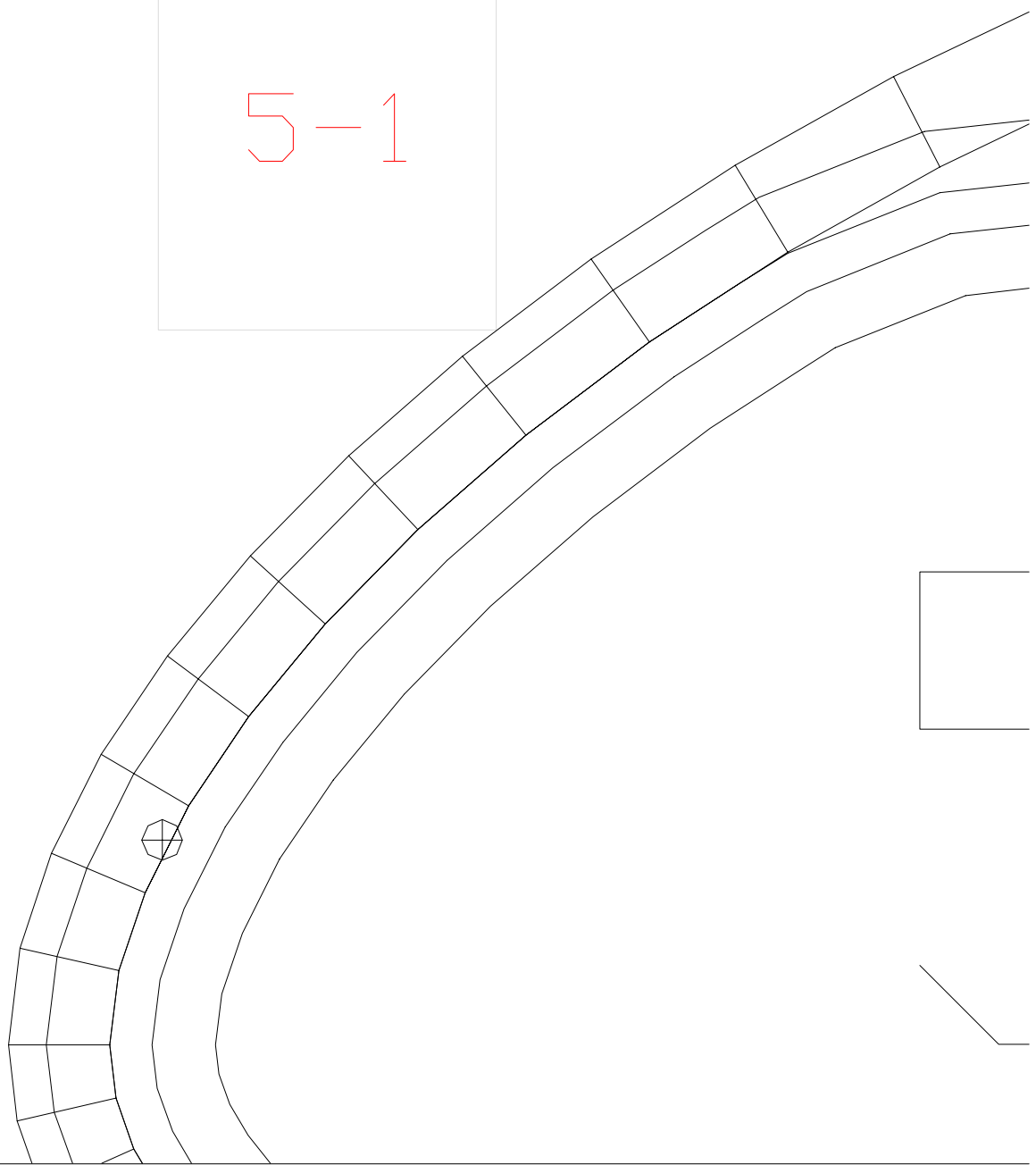

5-20

5-21

5-22

5-23

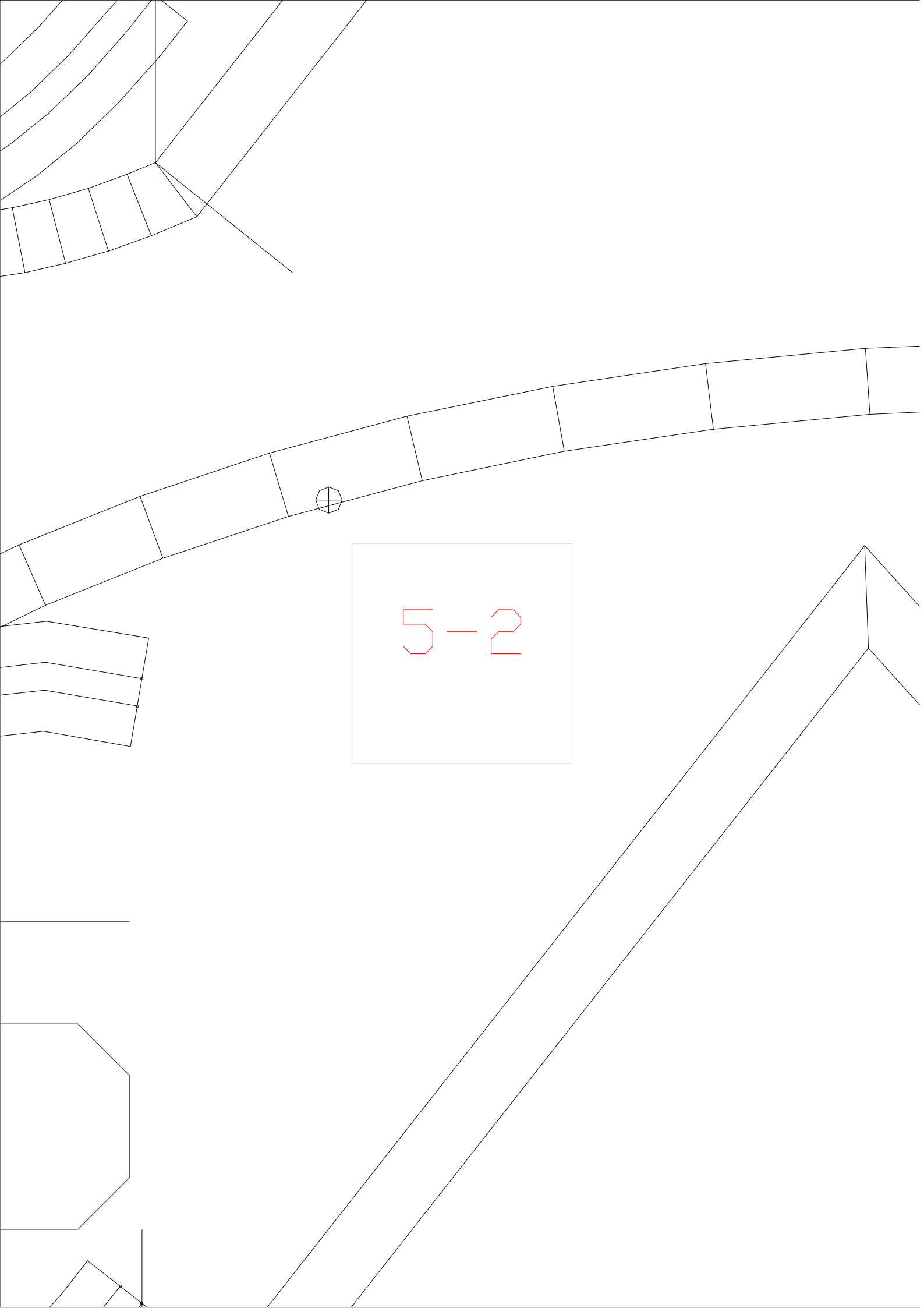

5-2

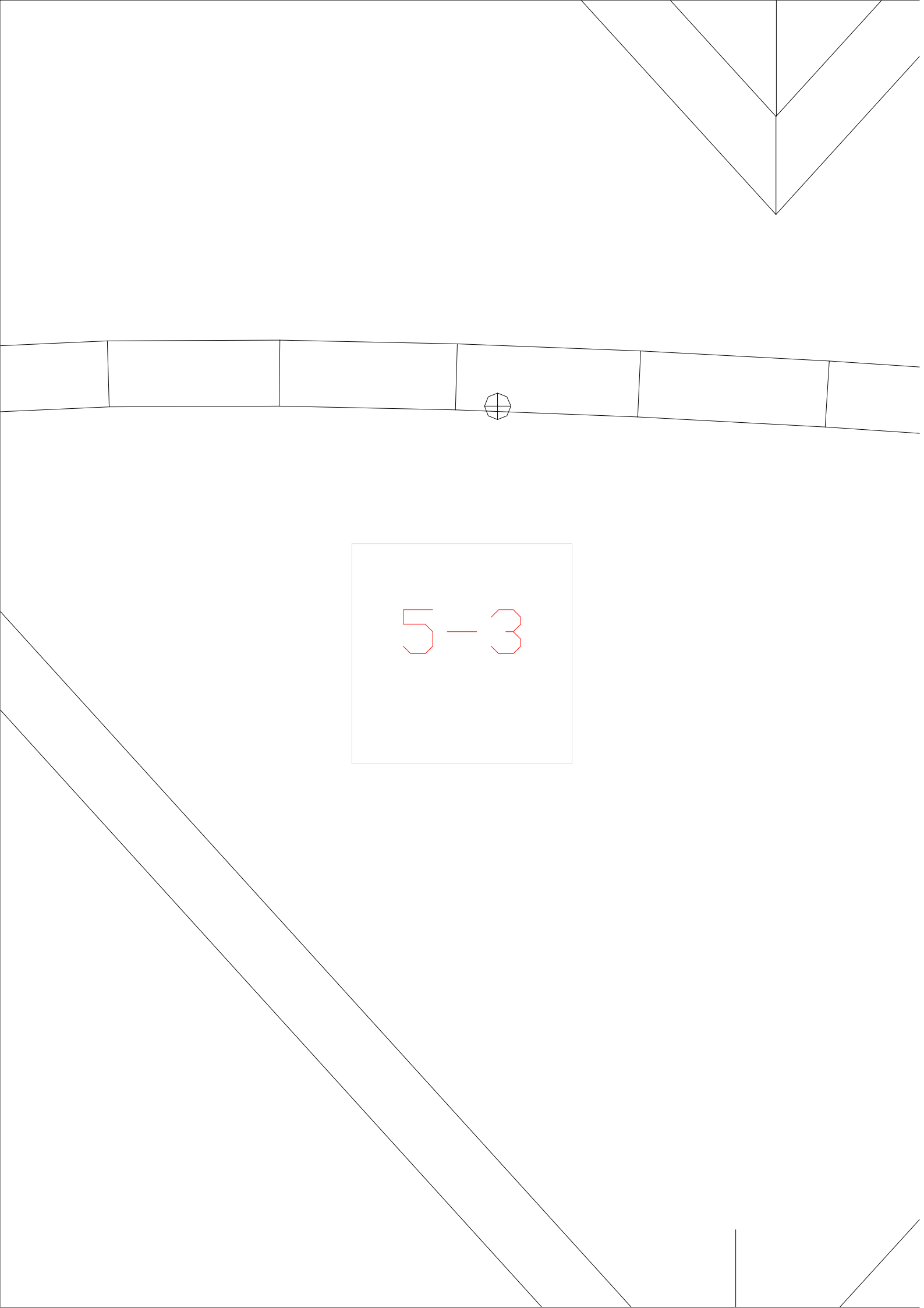

5-3

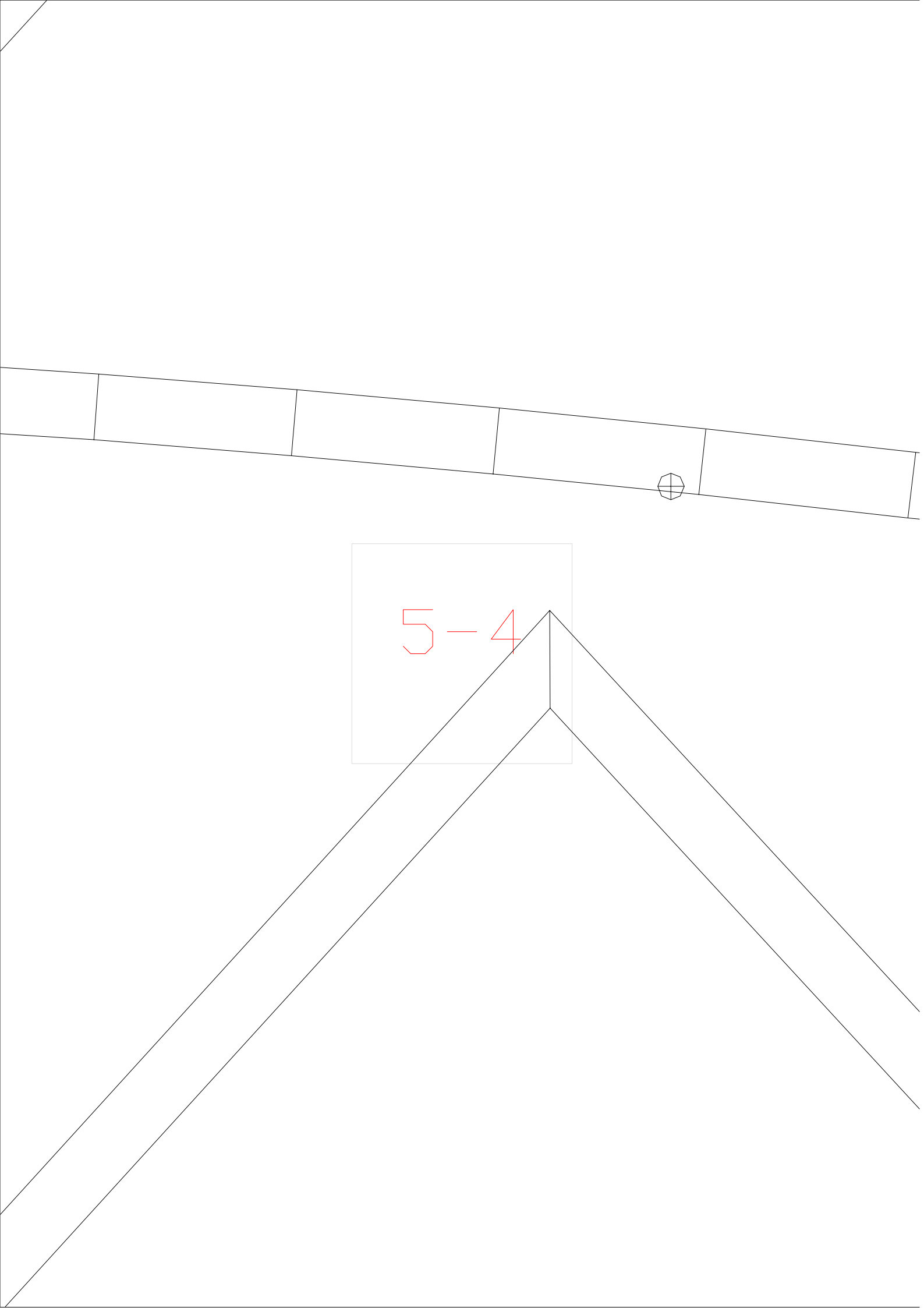

5-4

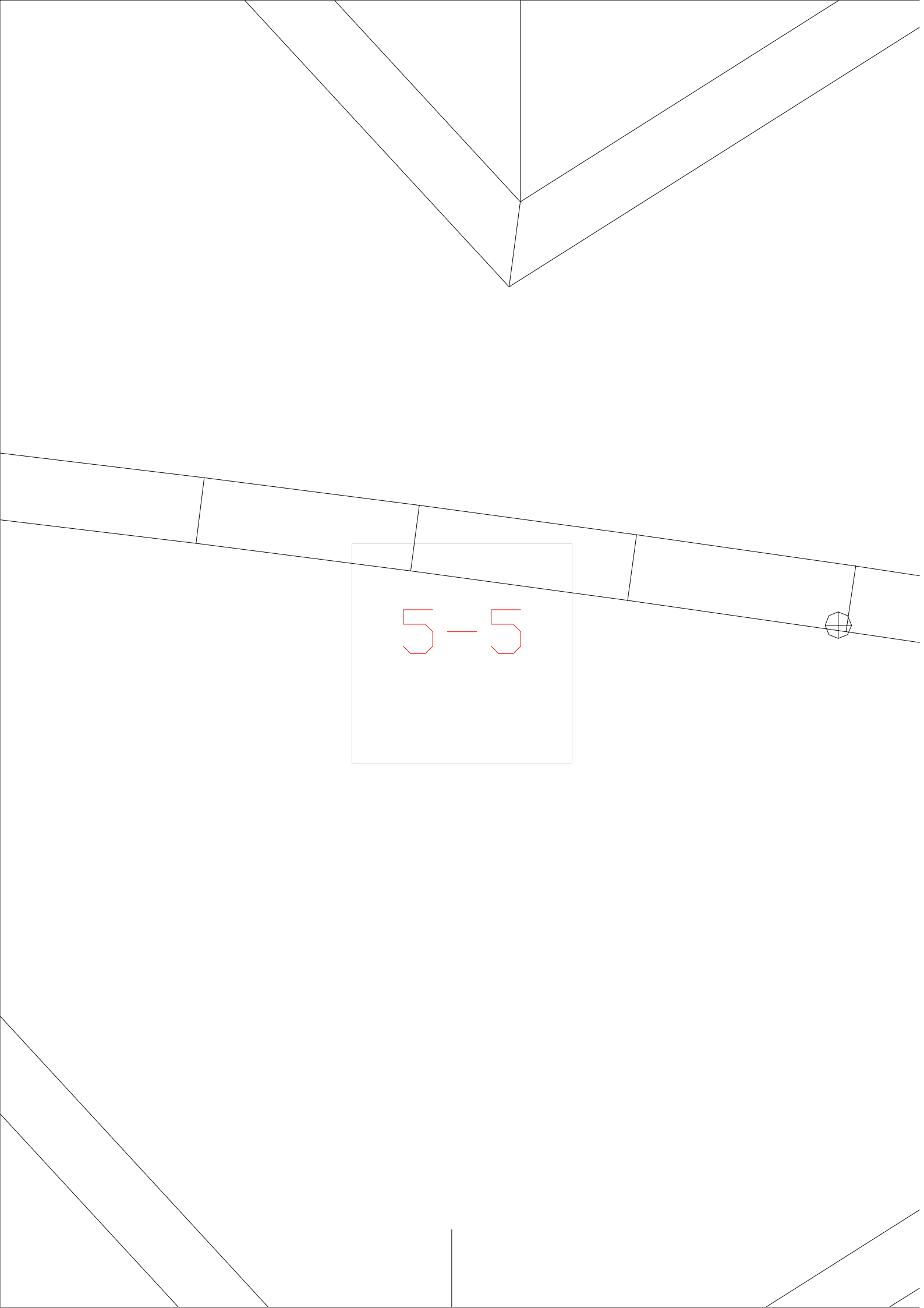

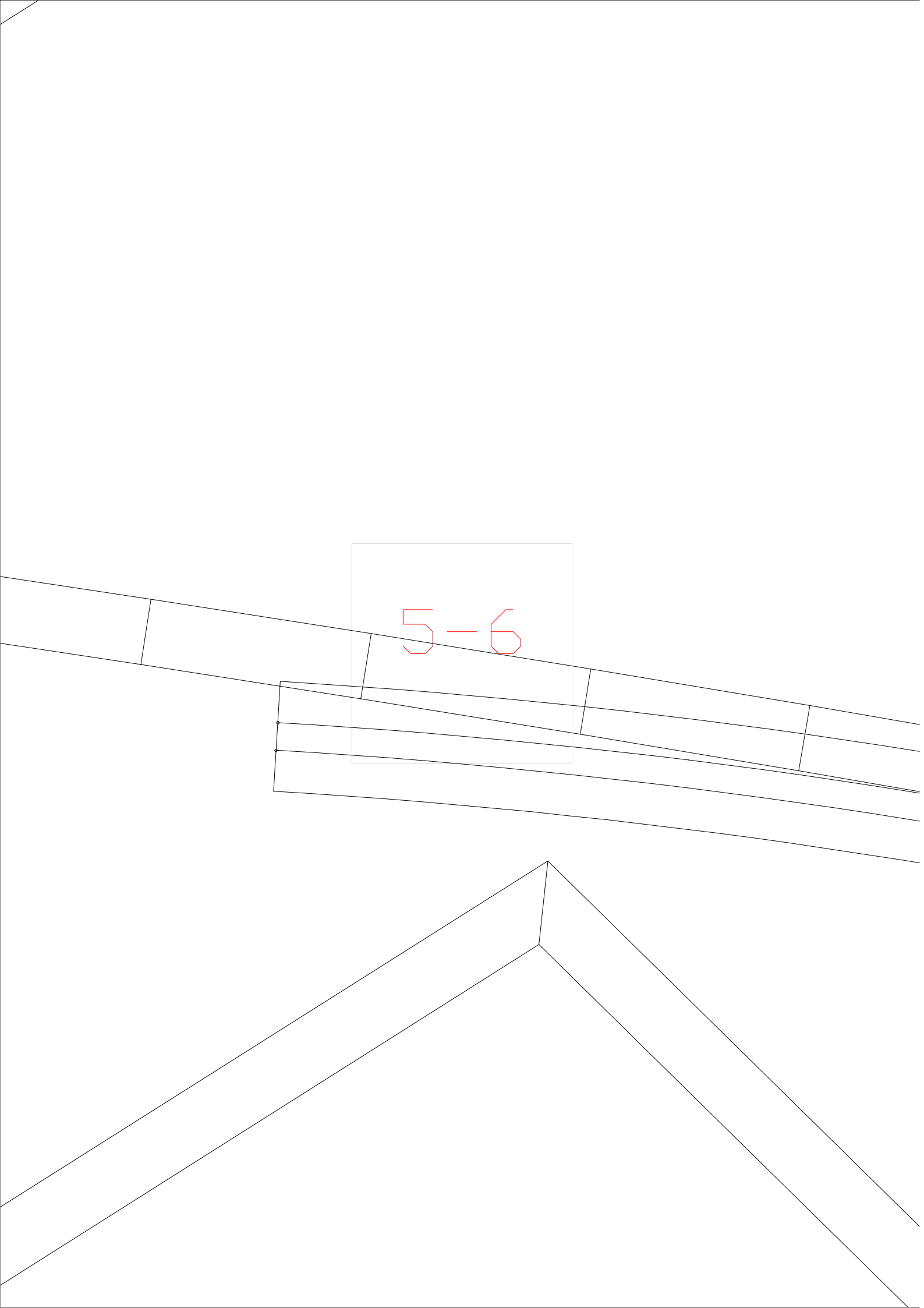

5-6

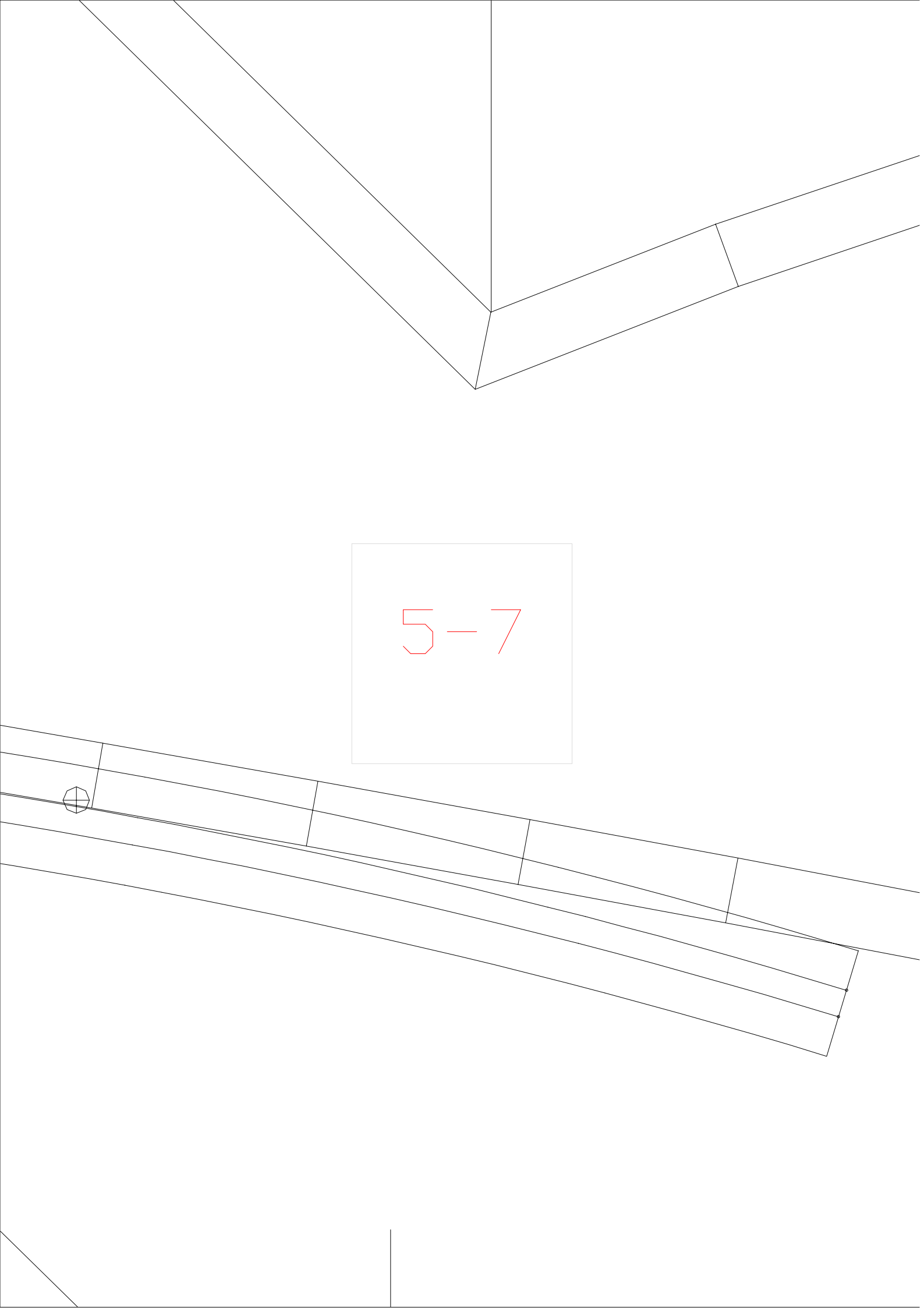

5-7

5-8

5-9

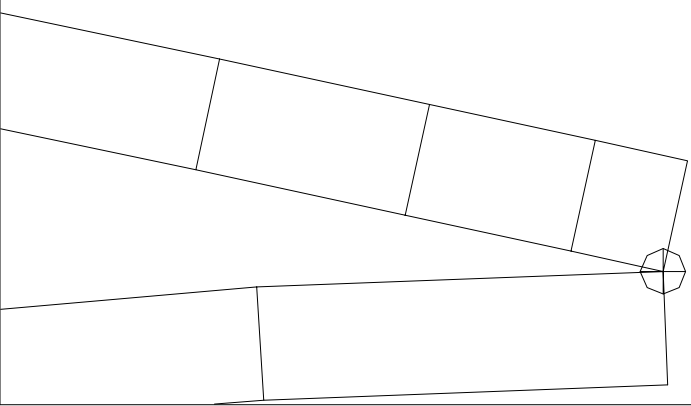

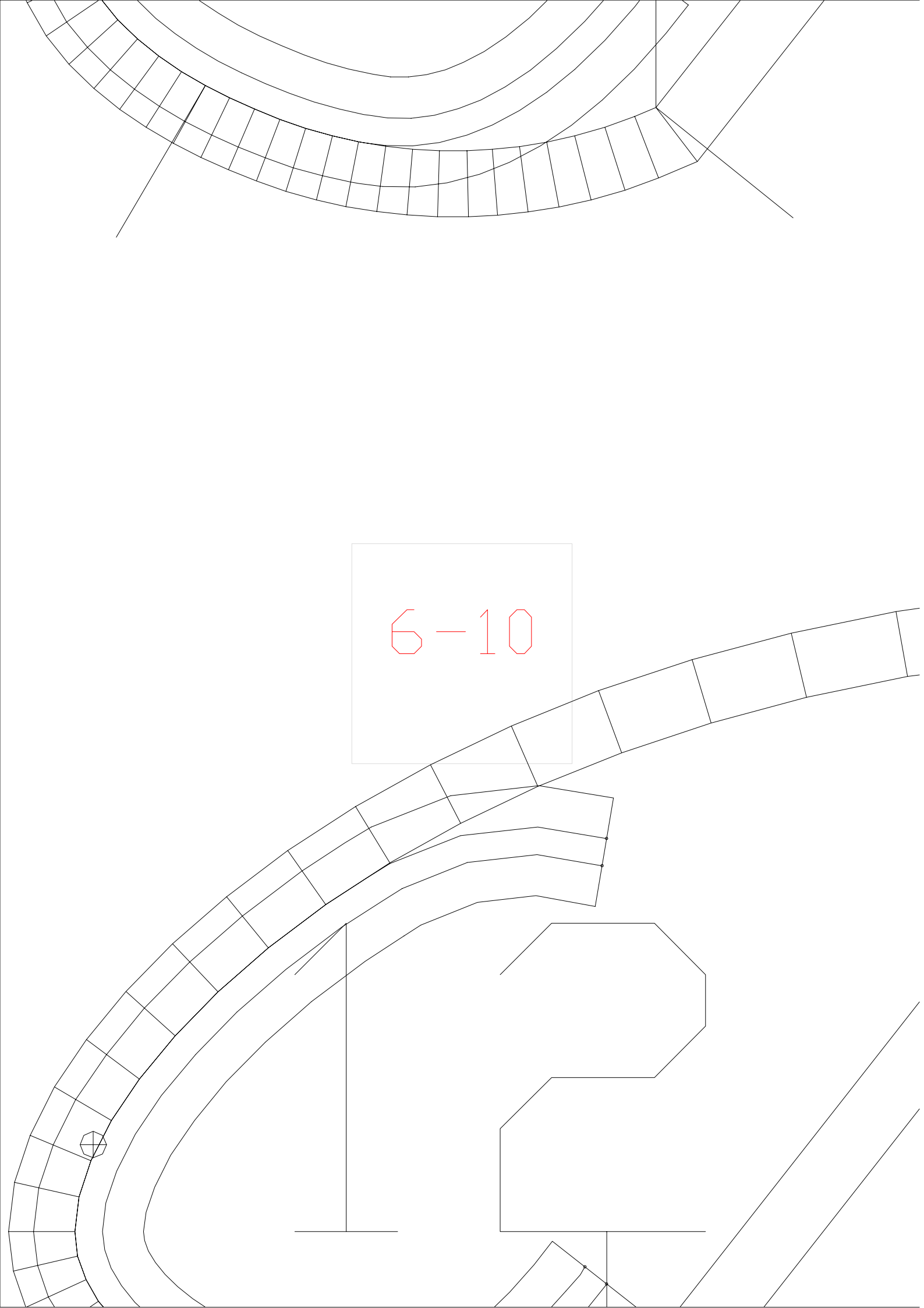

6-10

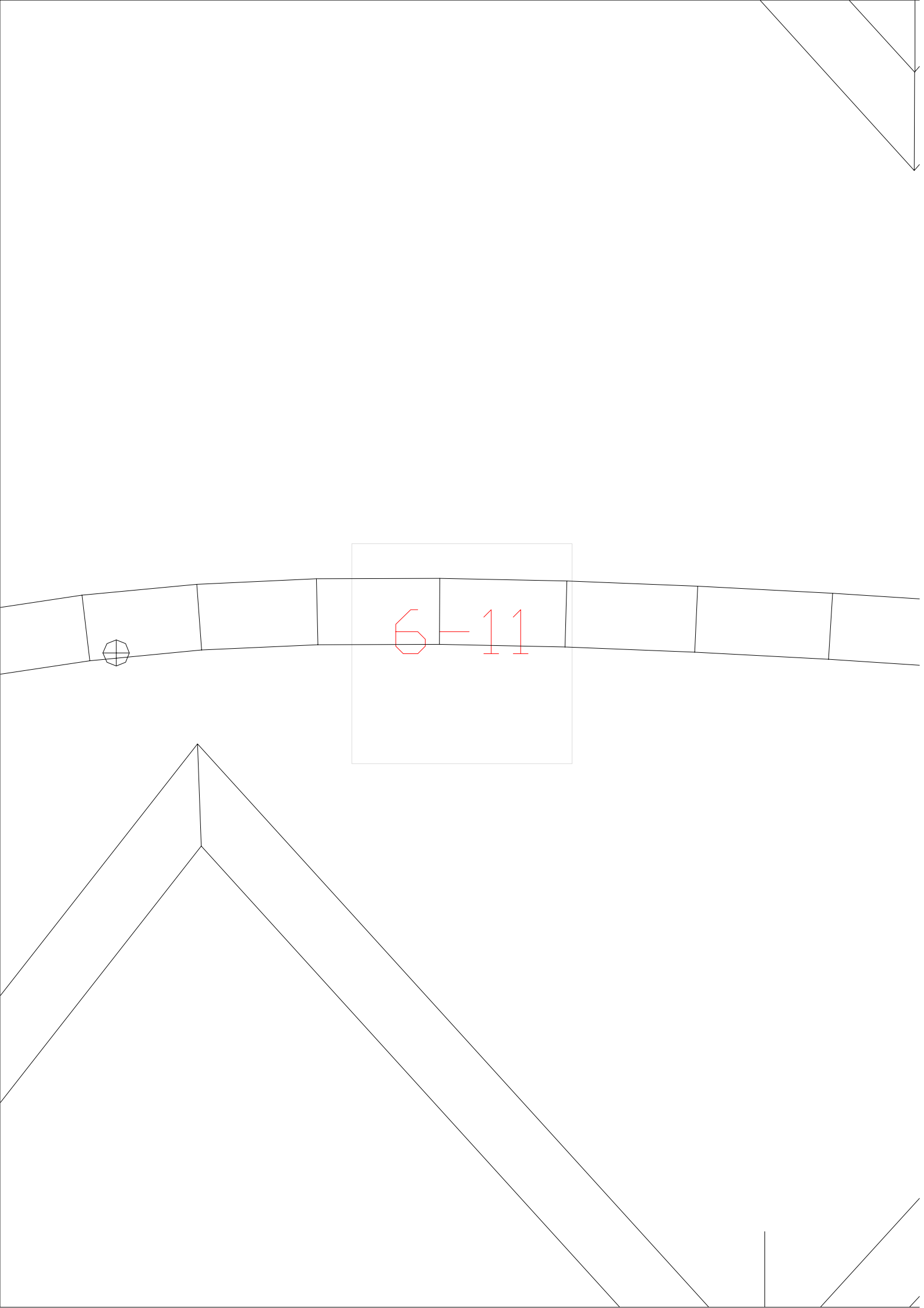

6-11

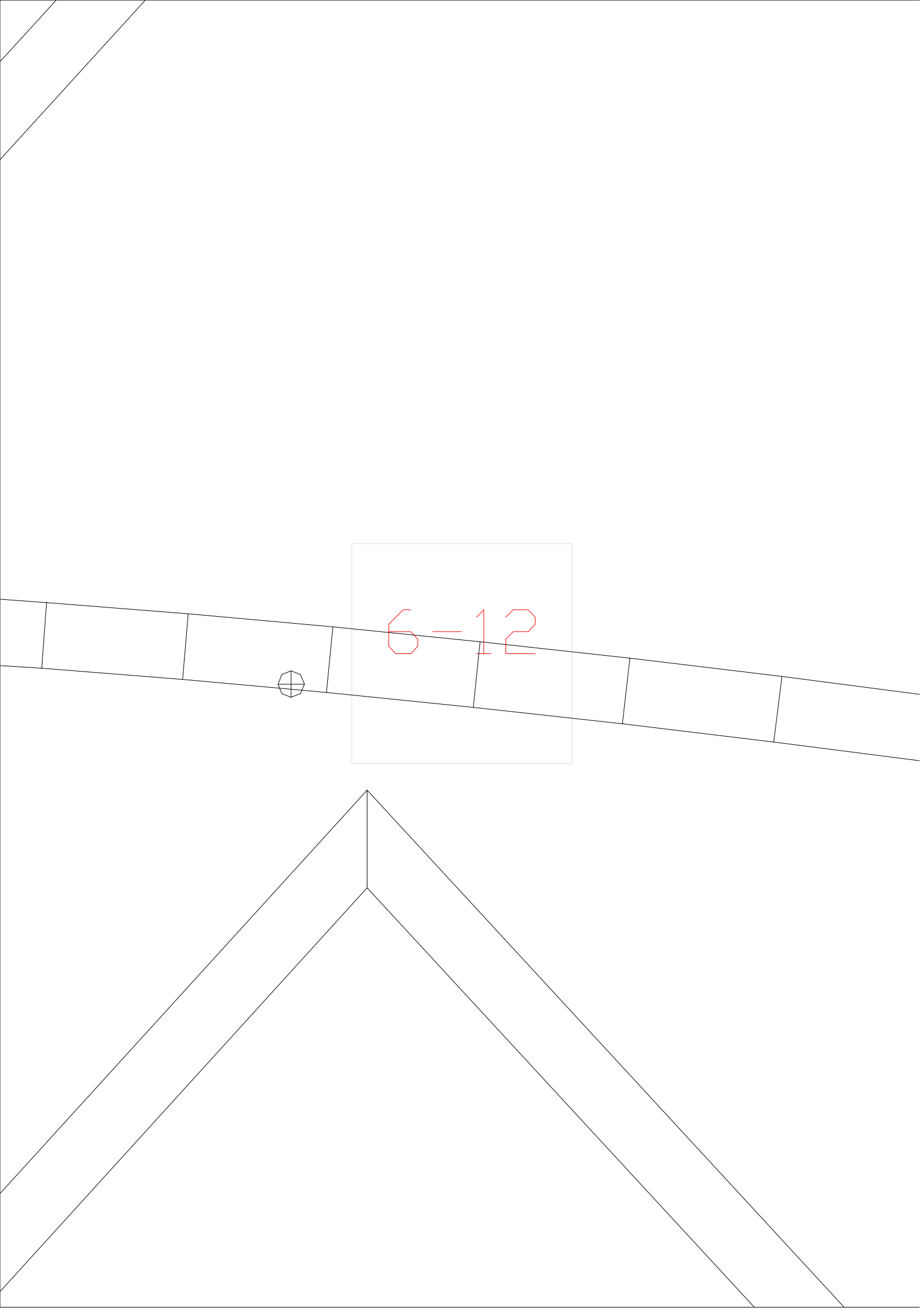

6-12

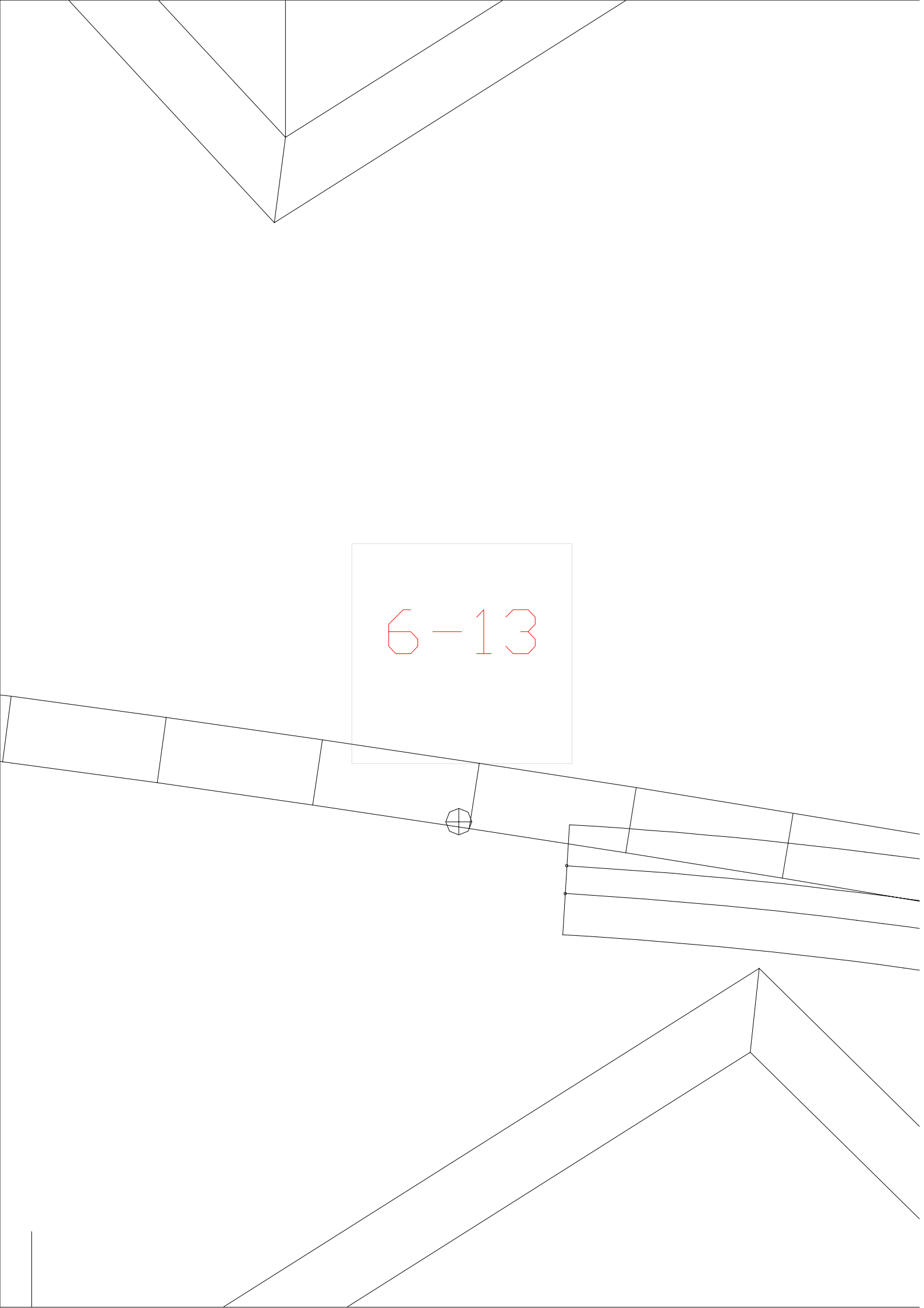

6-13

The image shows a technical drawing of a roof structure. At the top, there is a gabled roof section. Below it, a horizontal line represents a structural element, possibly a beam or a ridge, which is divided into several rectangular segments by vertical lines. A small circle with a cross inside is positioned on this line. To the right of this line, there are three parallel horizontal lines, suggesting a set of rafters or a specific roof profile. At the bottom, another gabled roof section is shown, mirroring the one at the top. The entire drawing is composed of black lines on a white background. A central rectangular box contains the red text '6-13'.

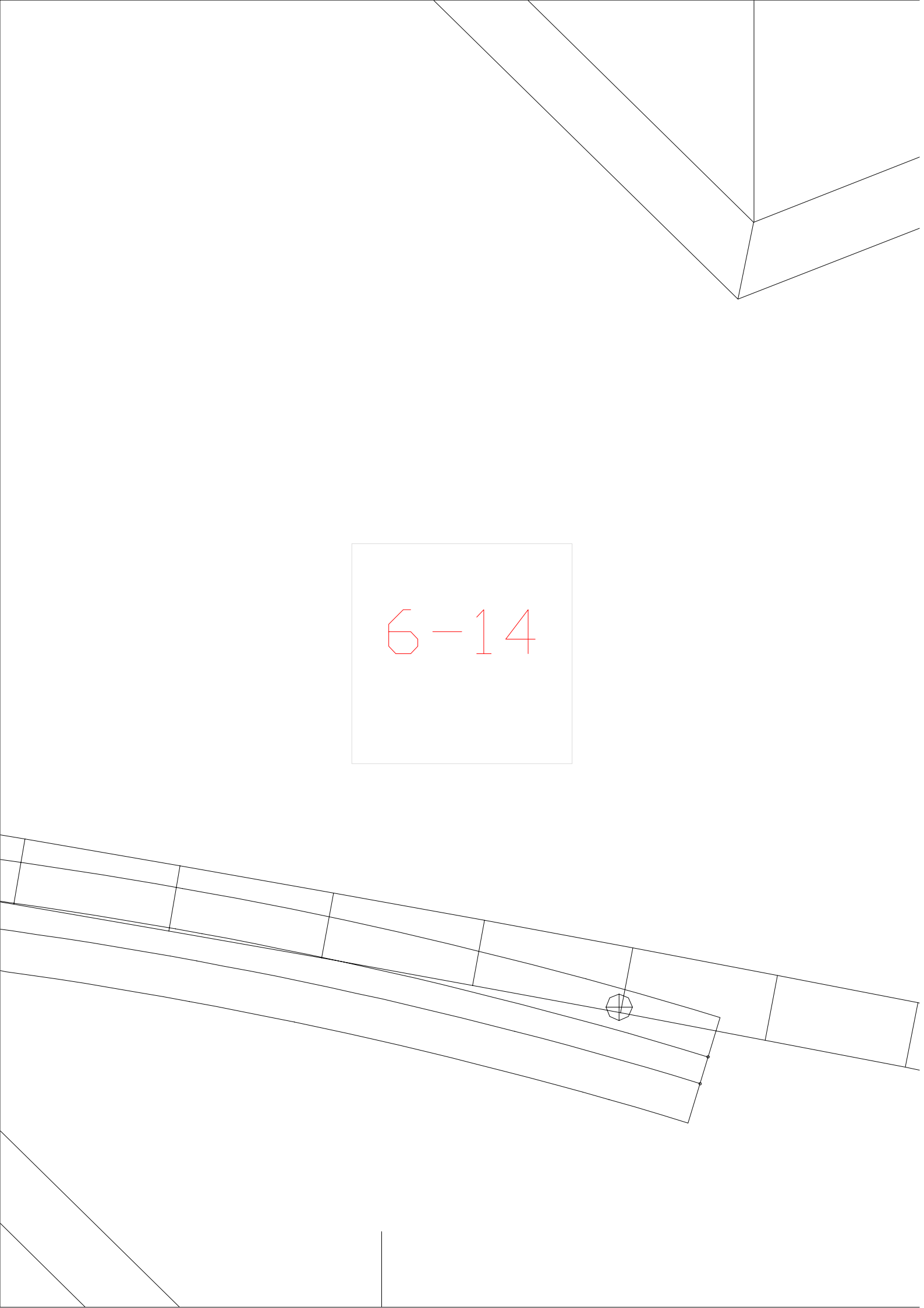

6-14

The image shows a technical drawing of a mechanical part, possibly a shaft or a beam, oriented diagonally. The part is divided into several segments by vertical lines. A small circular feature, likely a hole or a pin, is located on the lower surface of one of the segments. The drawing is rendered in black lines on a white background. In the center of the page, there is a rectangular box containing the text '6-14' in red. The top right corner of the drawing shows a corner detail with a chamfered edge. The bottom left corner shows a partial view of another part of the drawing.

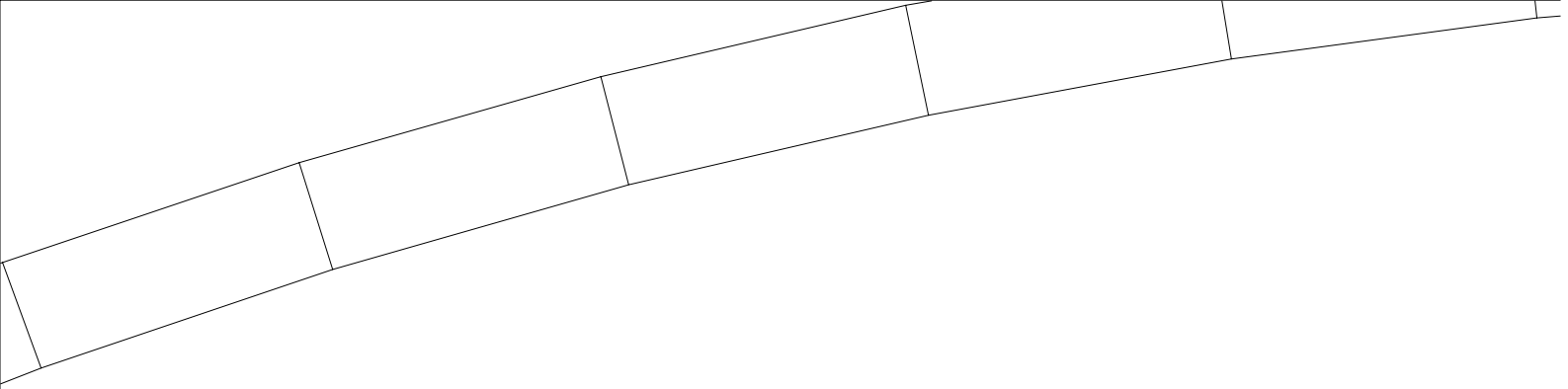

6-15

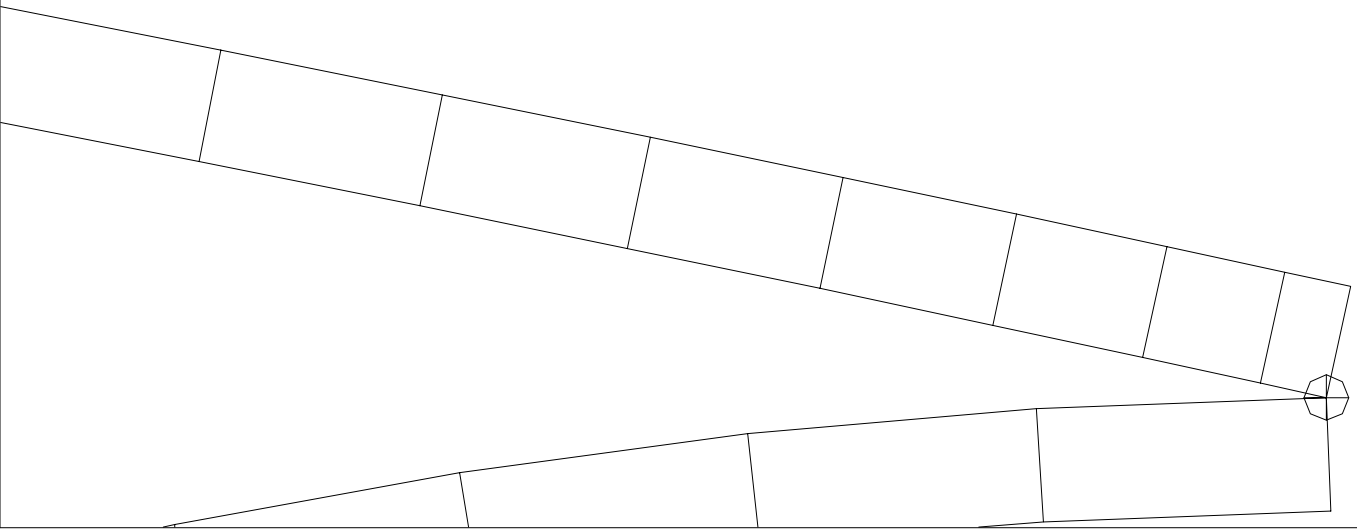

6-16

6-17

6-18

6-19

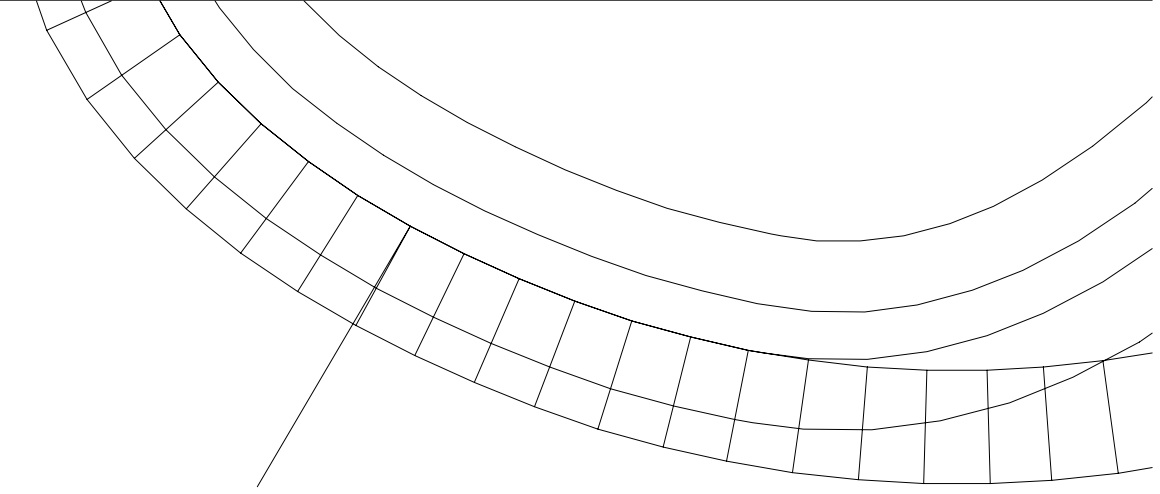

6-1

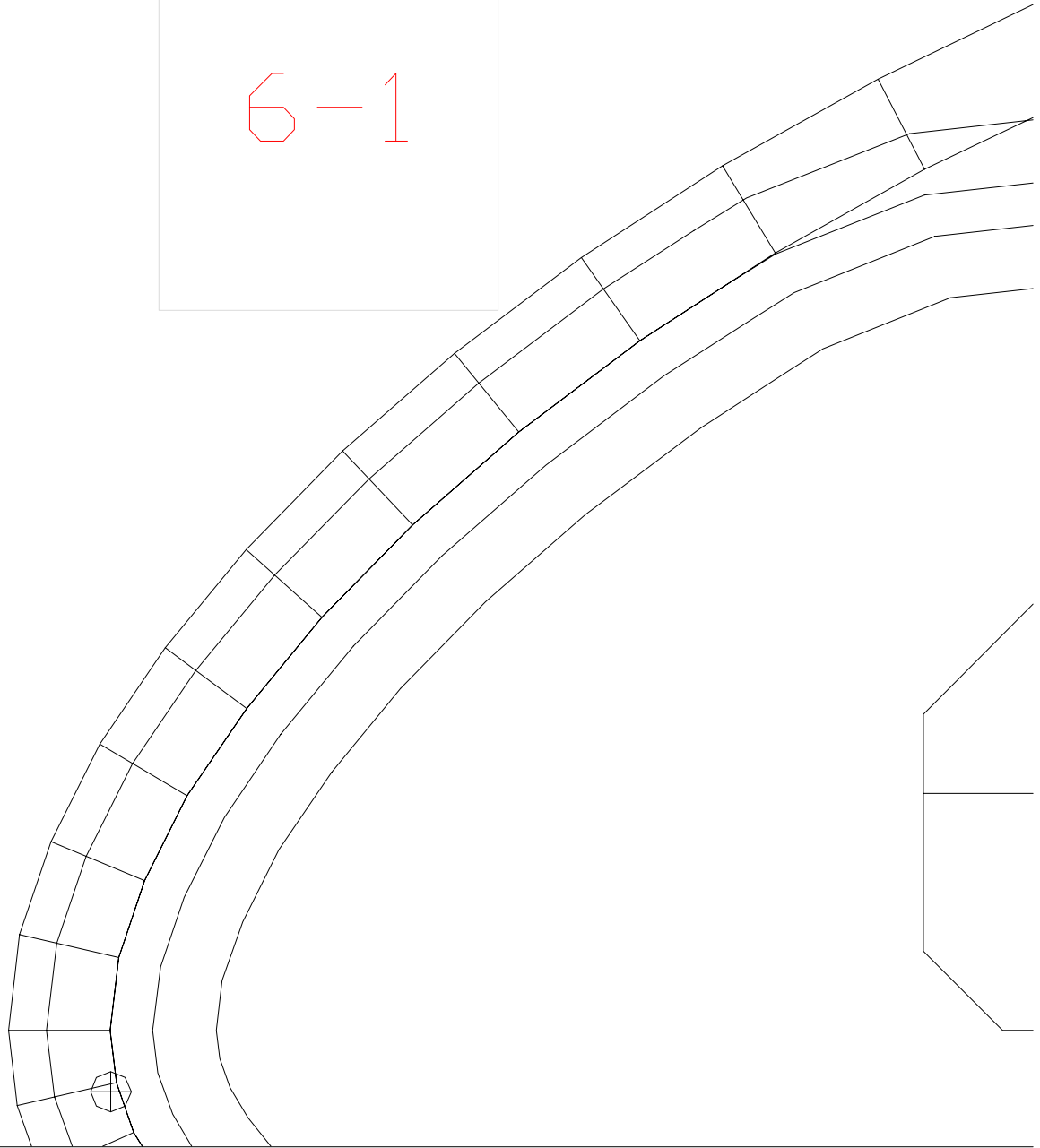

6-20

6-21

6-22

6-23

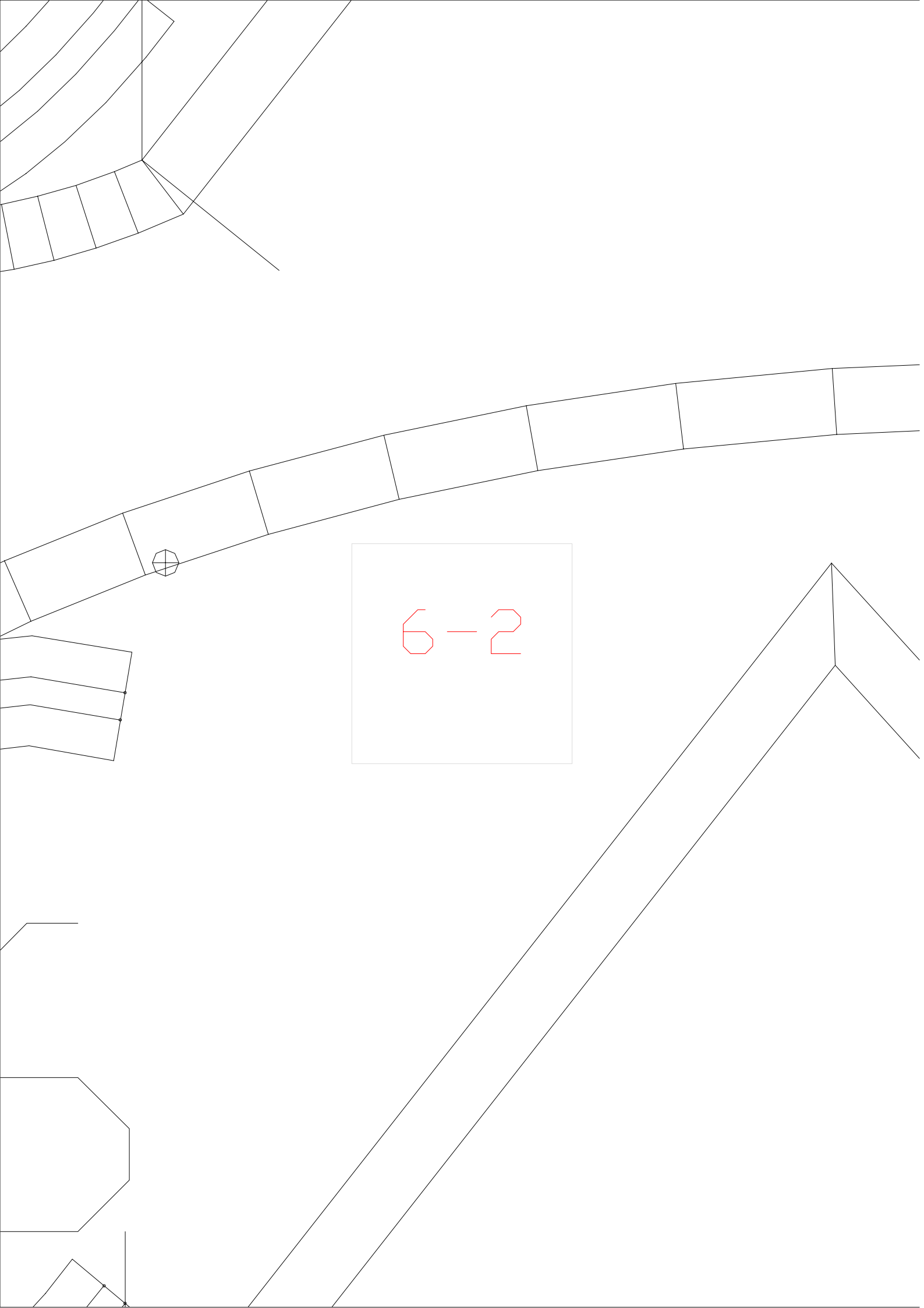

6-2

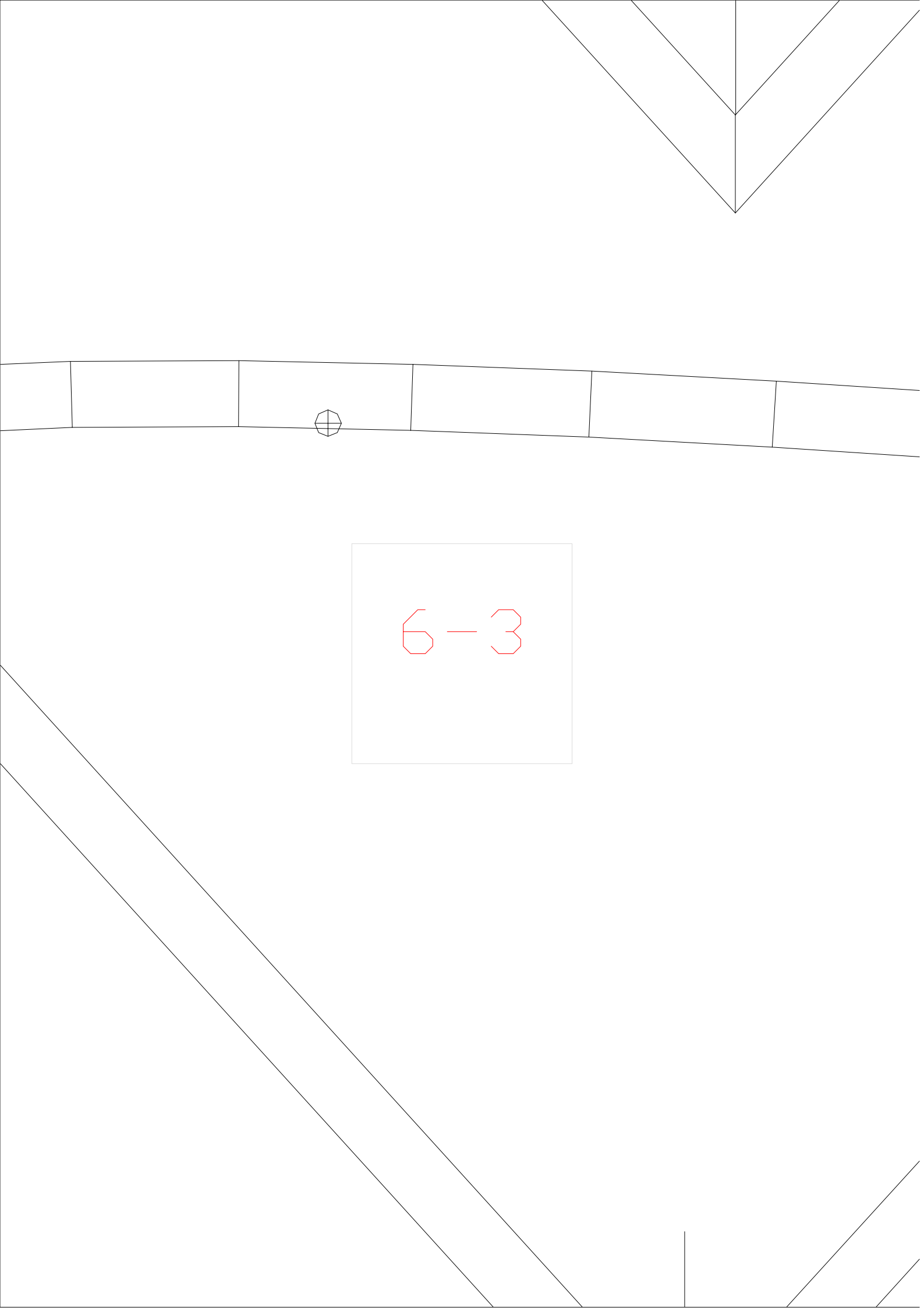

6-3

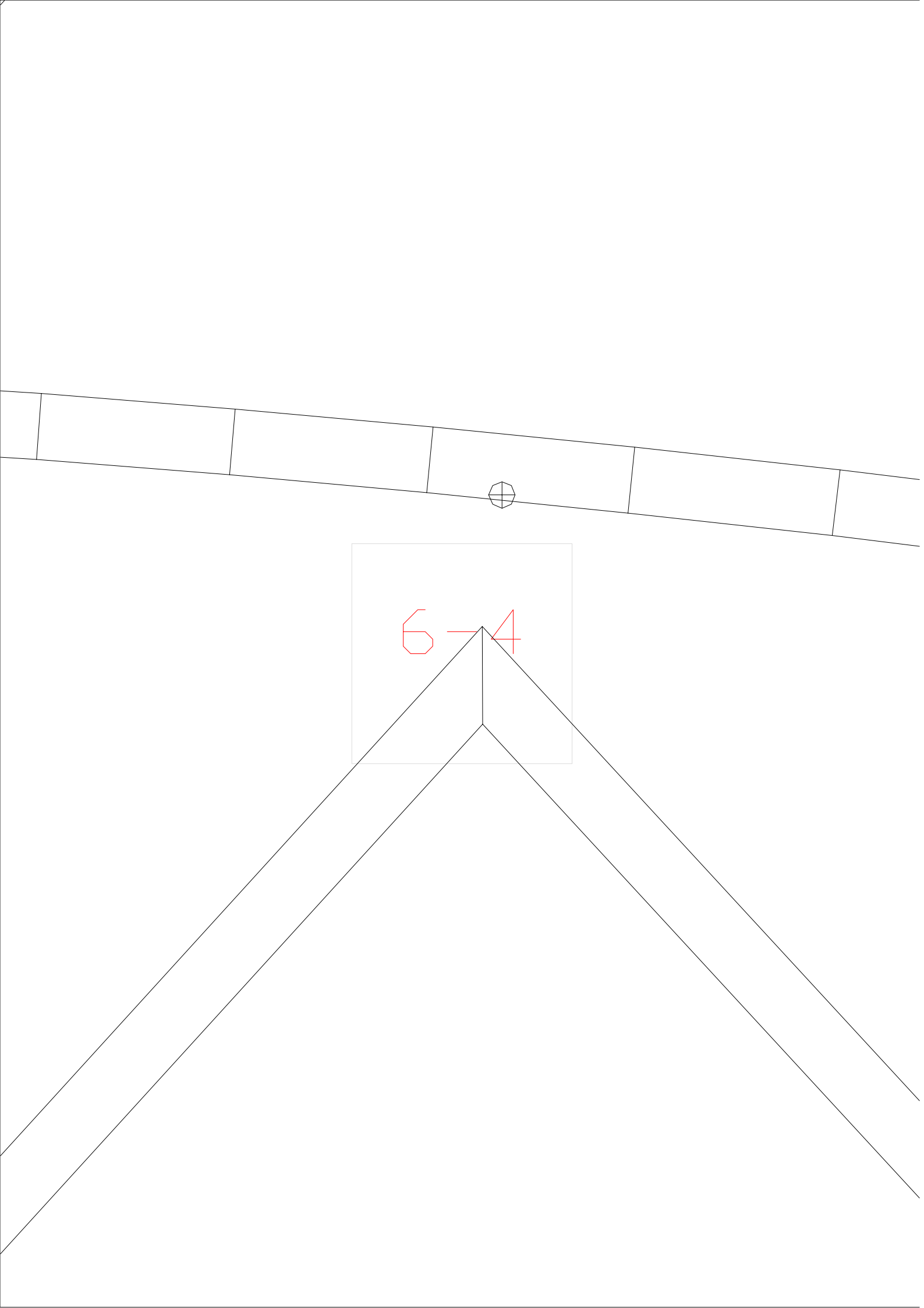

6-4

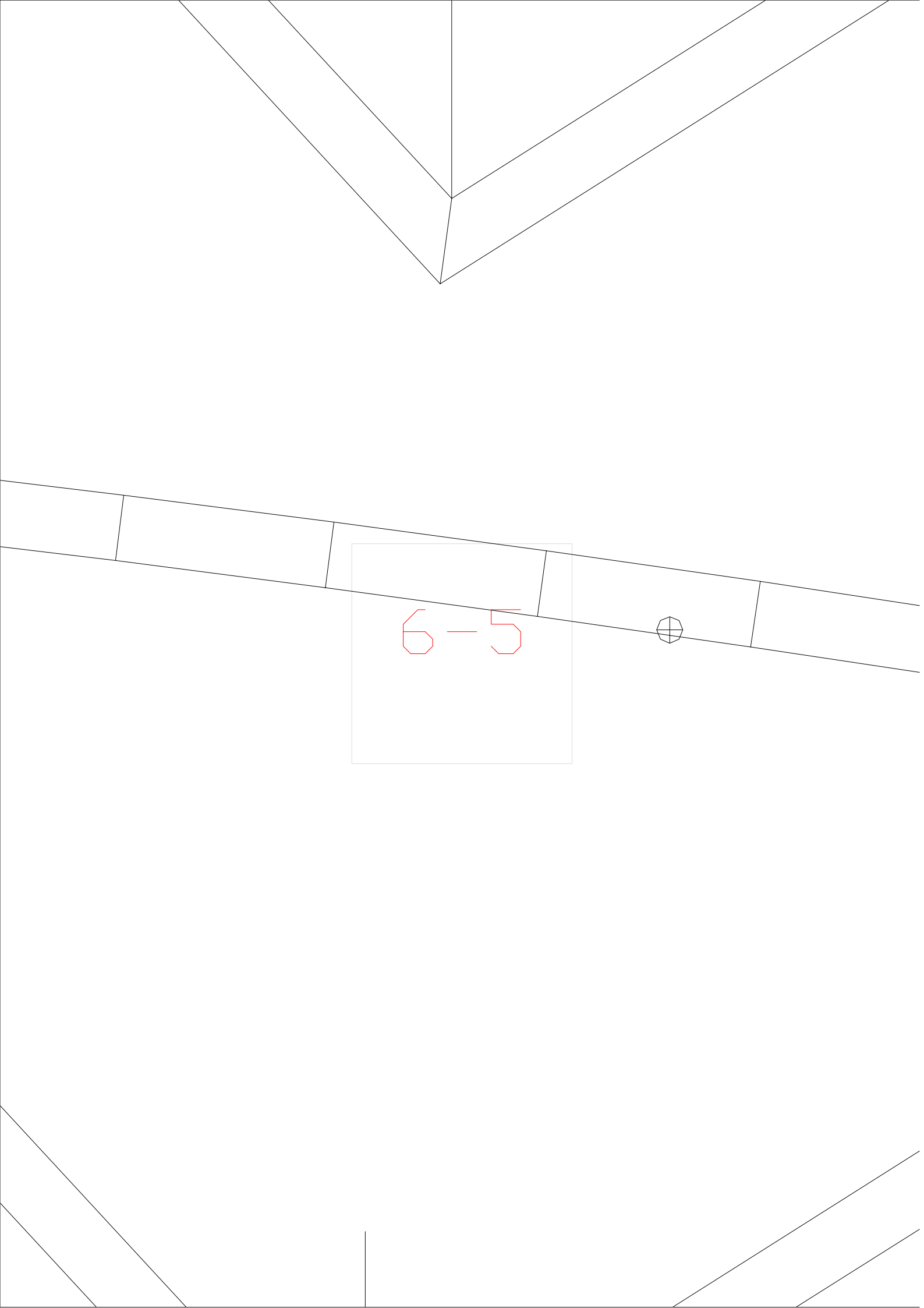

6-6



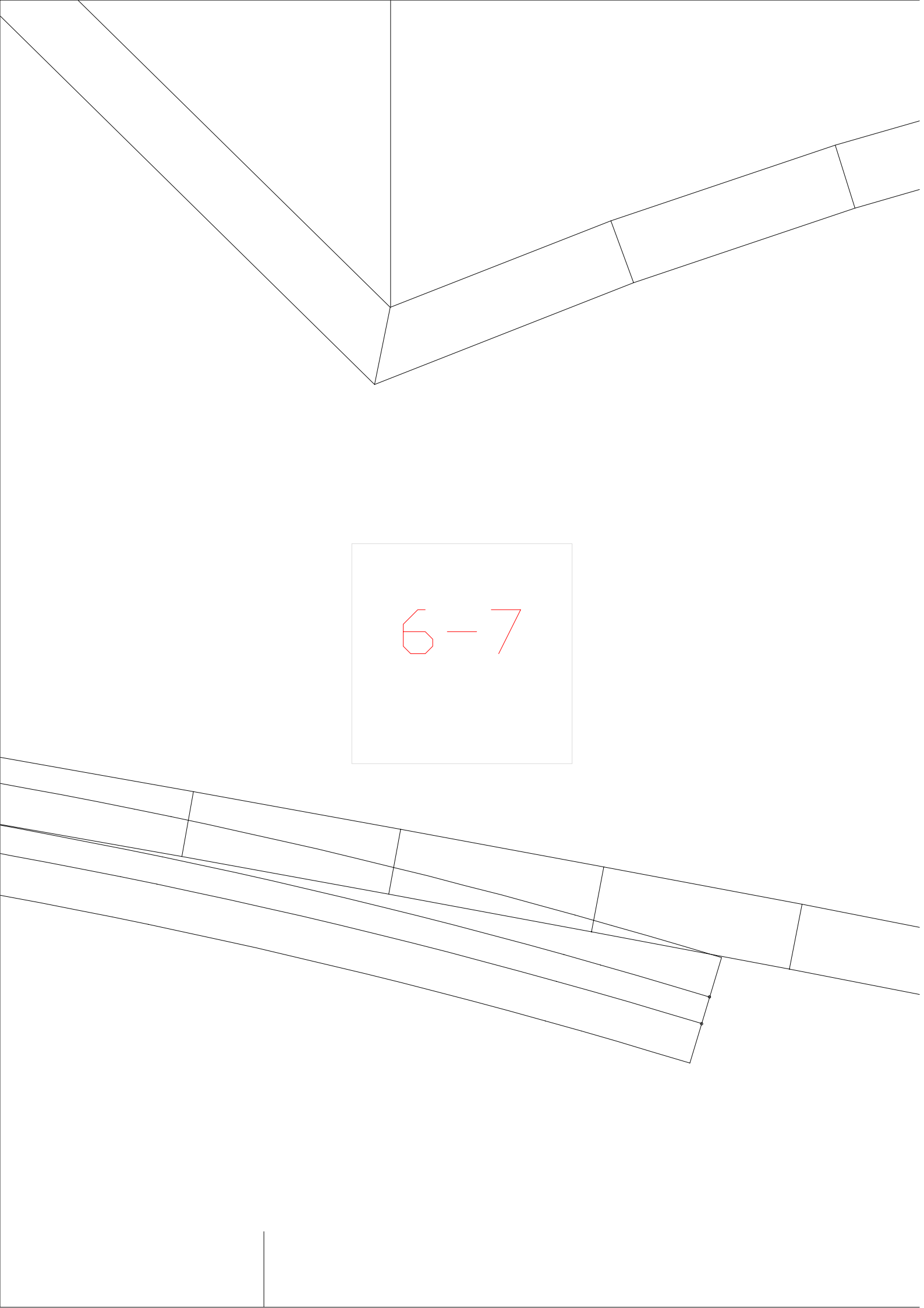

6-7

6-8

6-9

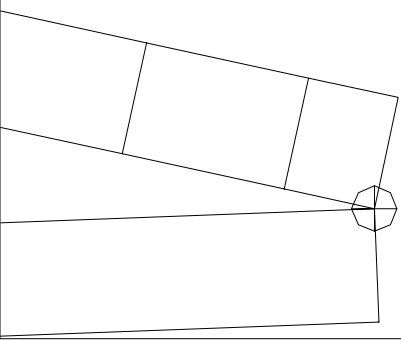

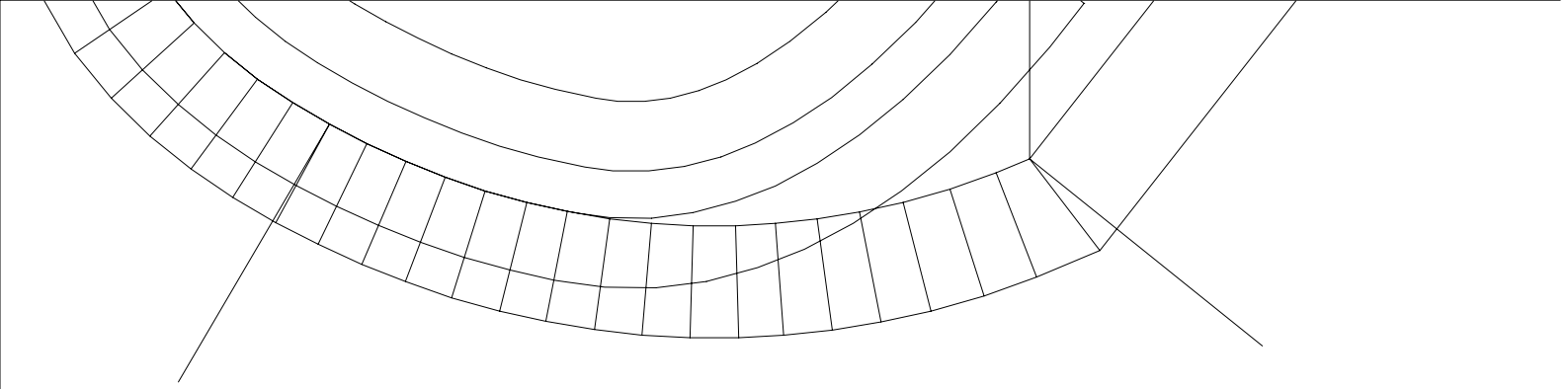

7-10

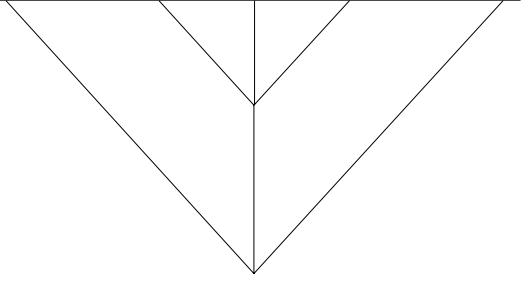

7-11

7-12

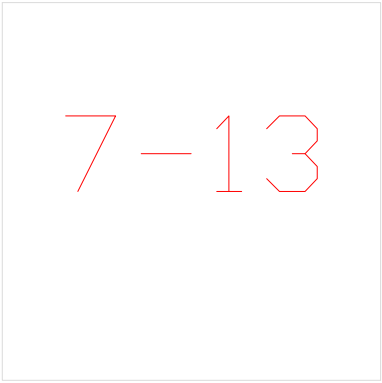

7-13

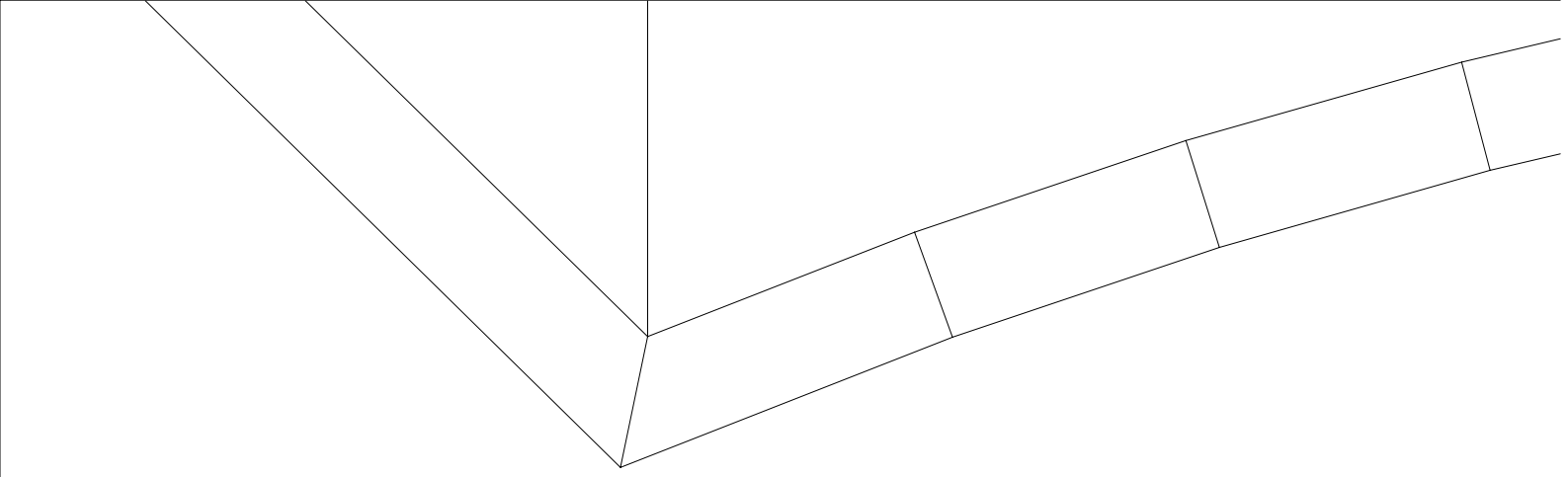

7-14

7-15

7-16

7-17

7-18

7-19

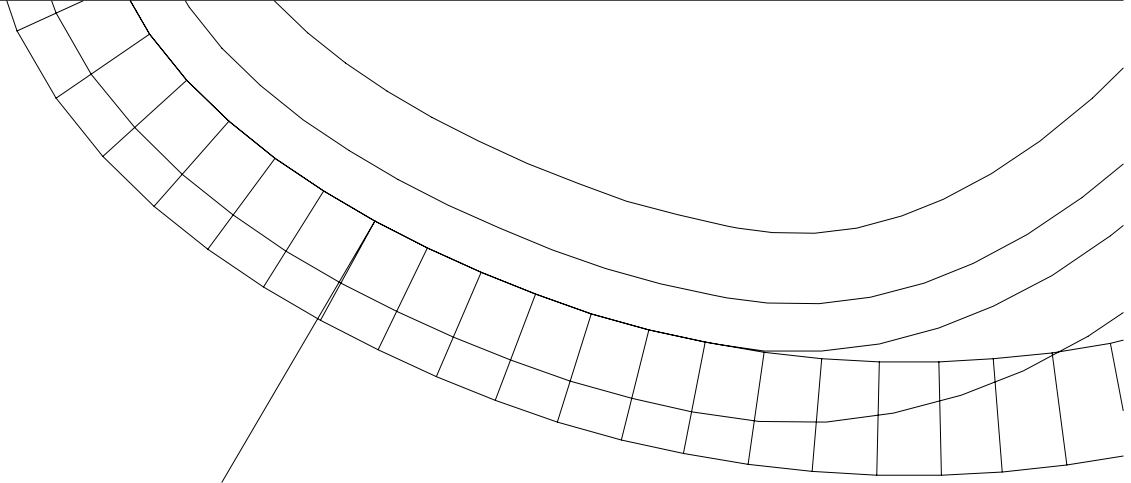

$$7 - 1$$

7-20

7-21

7-22

7-23

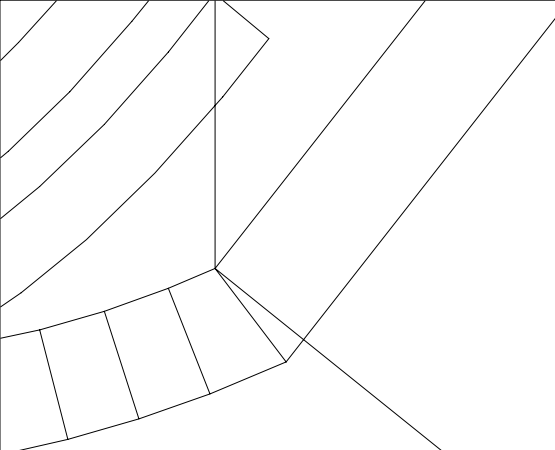

7-2

$$7 - 3$$

$$7 - 5$$

7-6

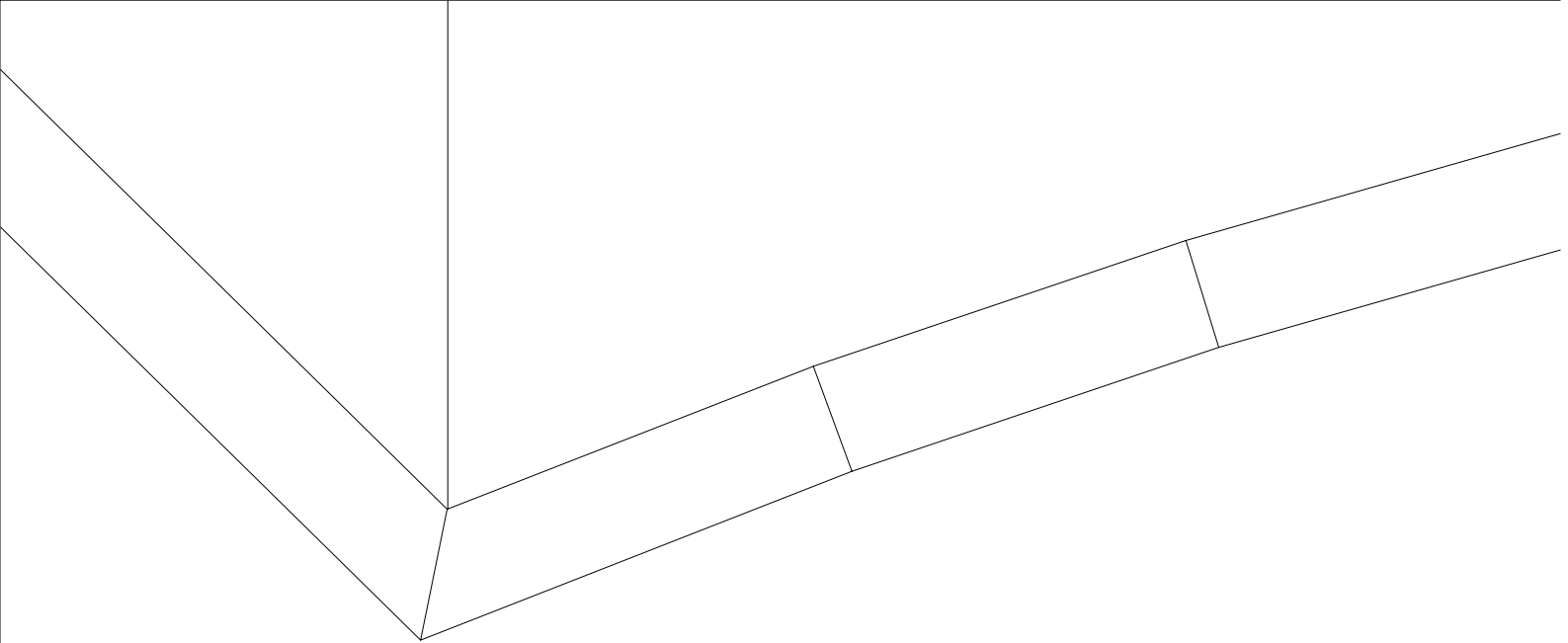

7-7

7-8

7-9