

1-10

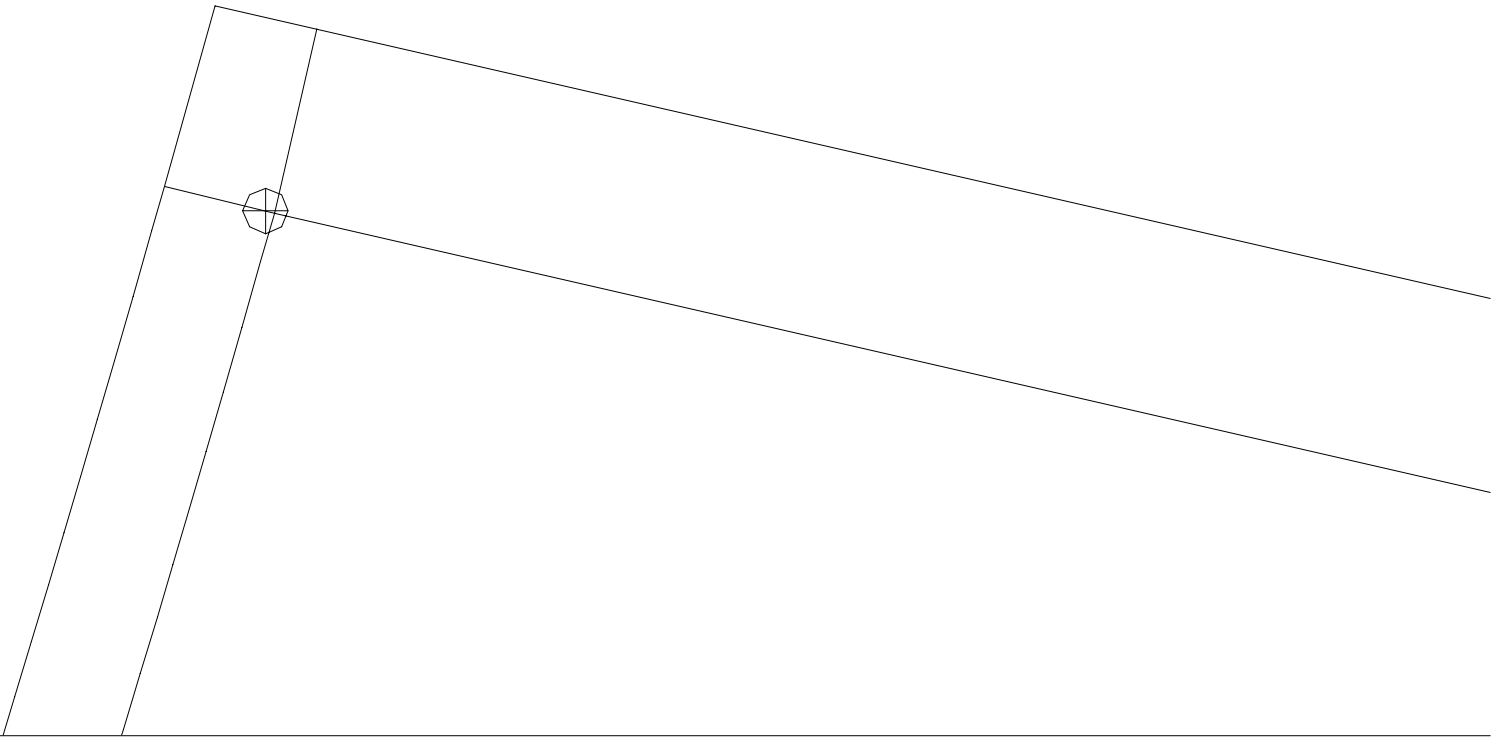

1-11



1-12

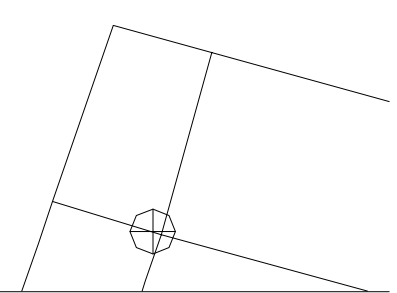
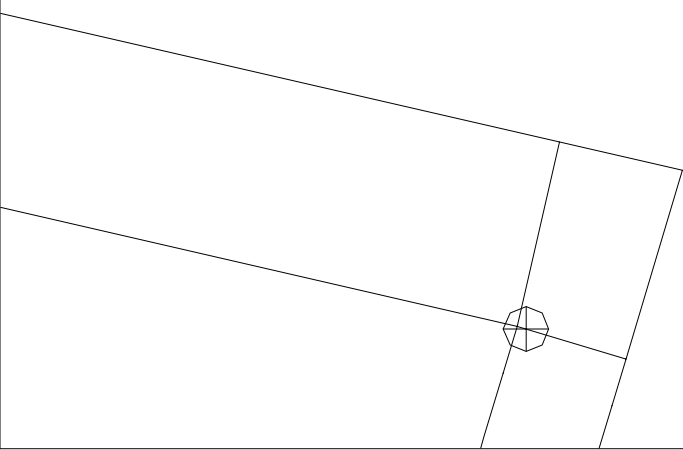

1-13

1-15

1-16

1-18

1-19

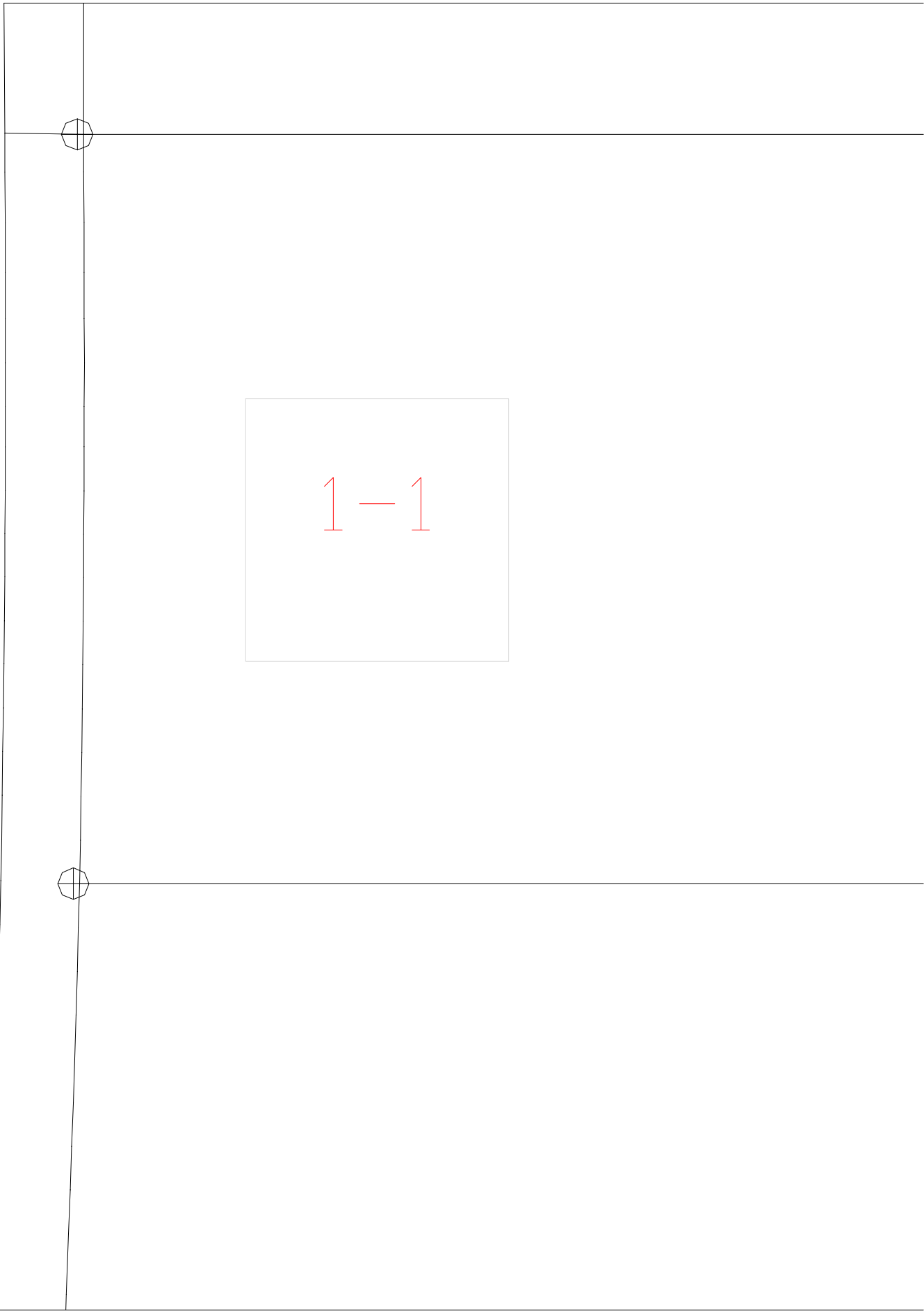

1-20

1-21

1-22

1-23



1-24

1-25

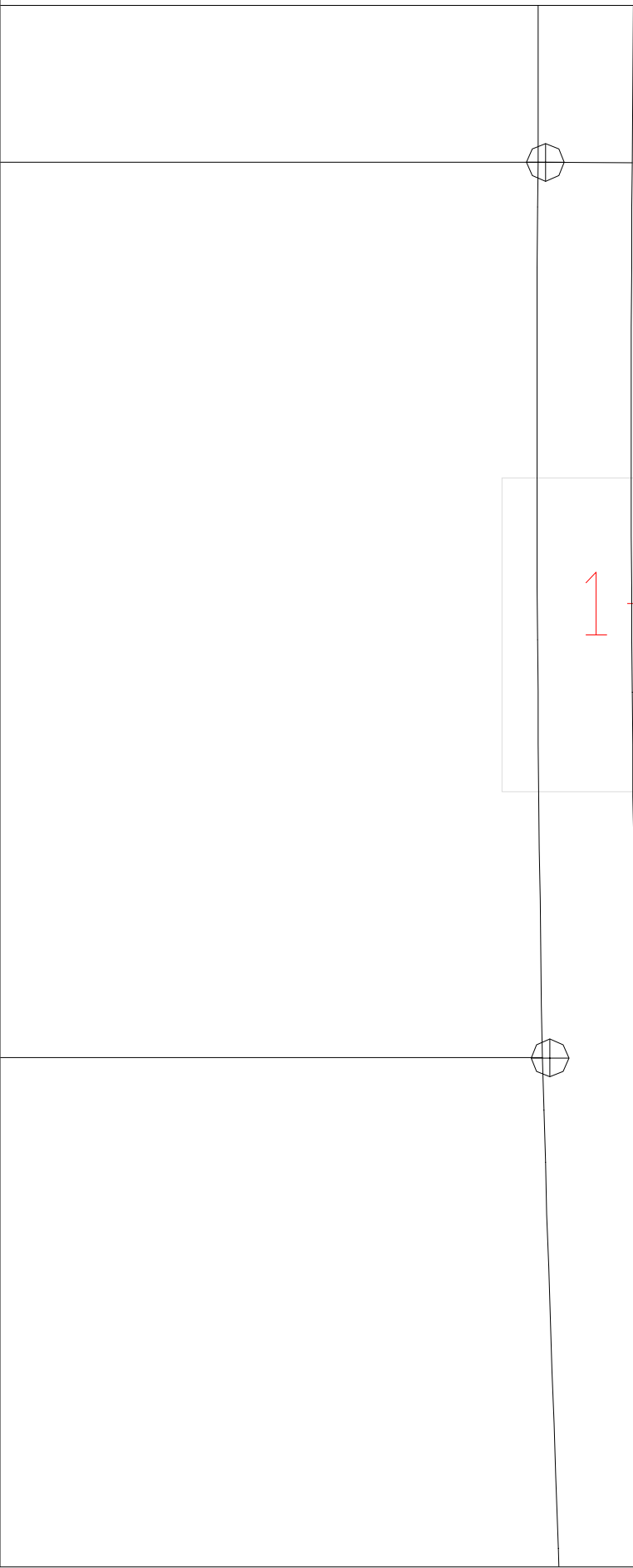

1-2

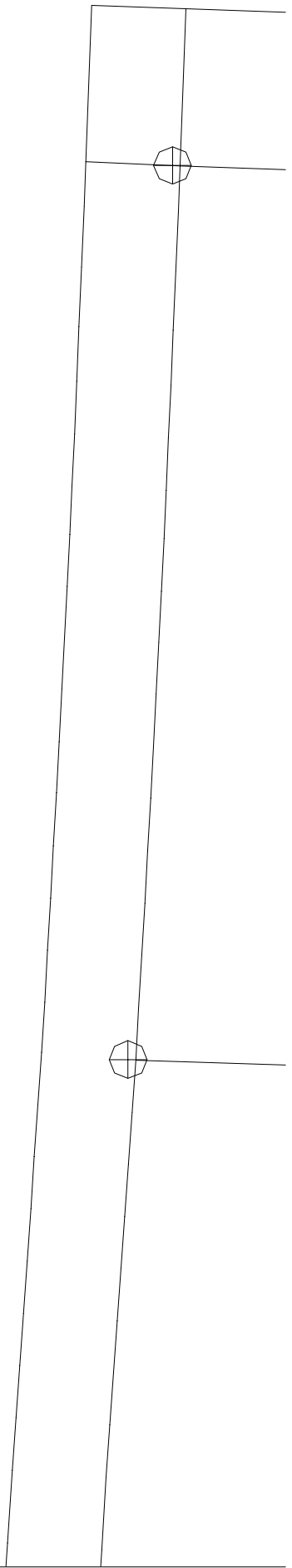

1-3

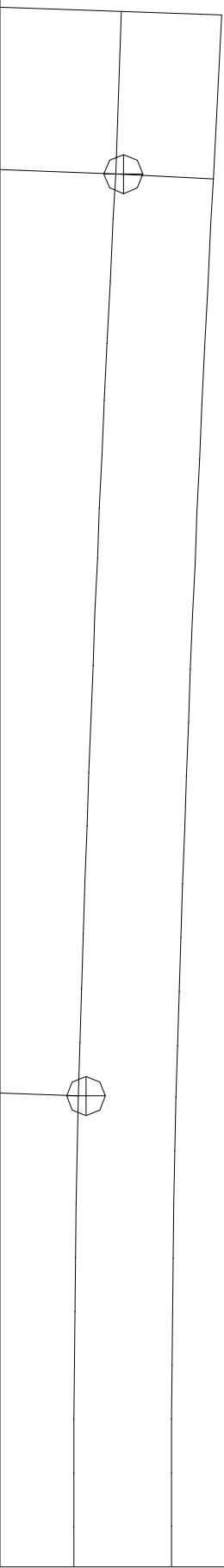

1-4

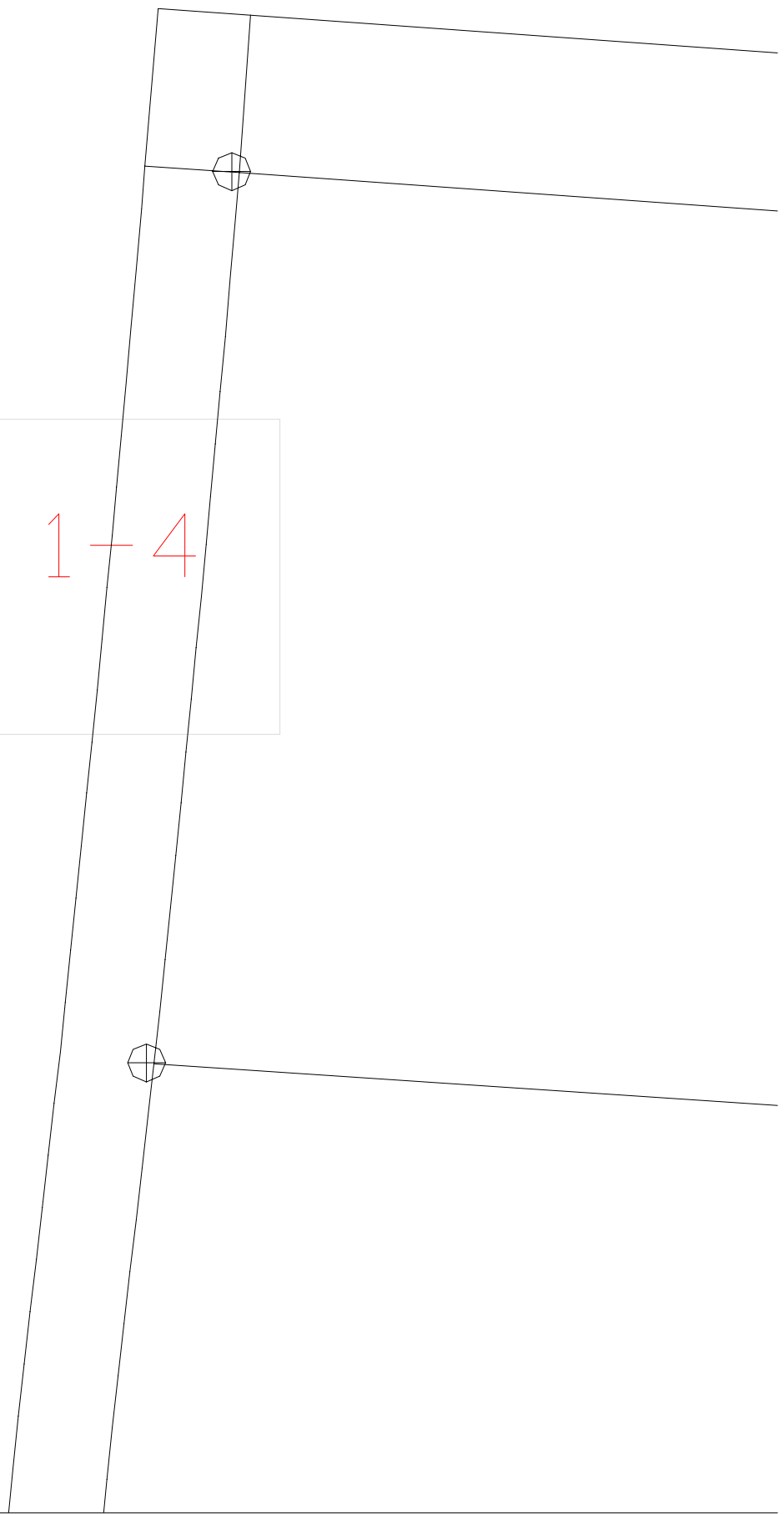



1-5

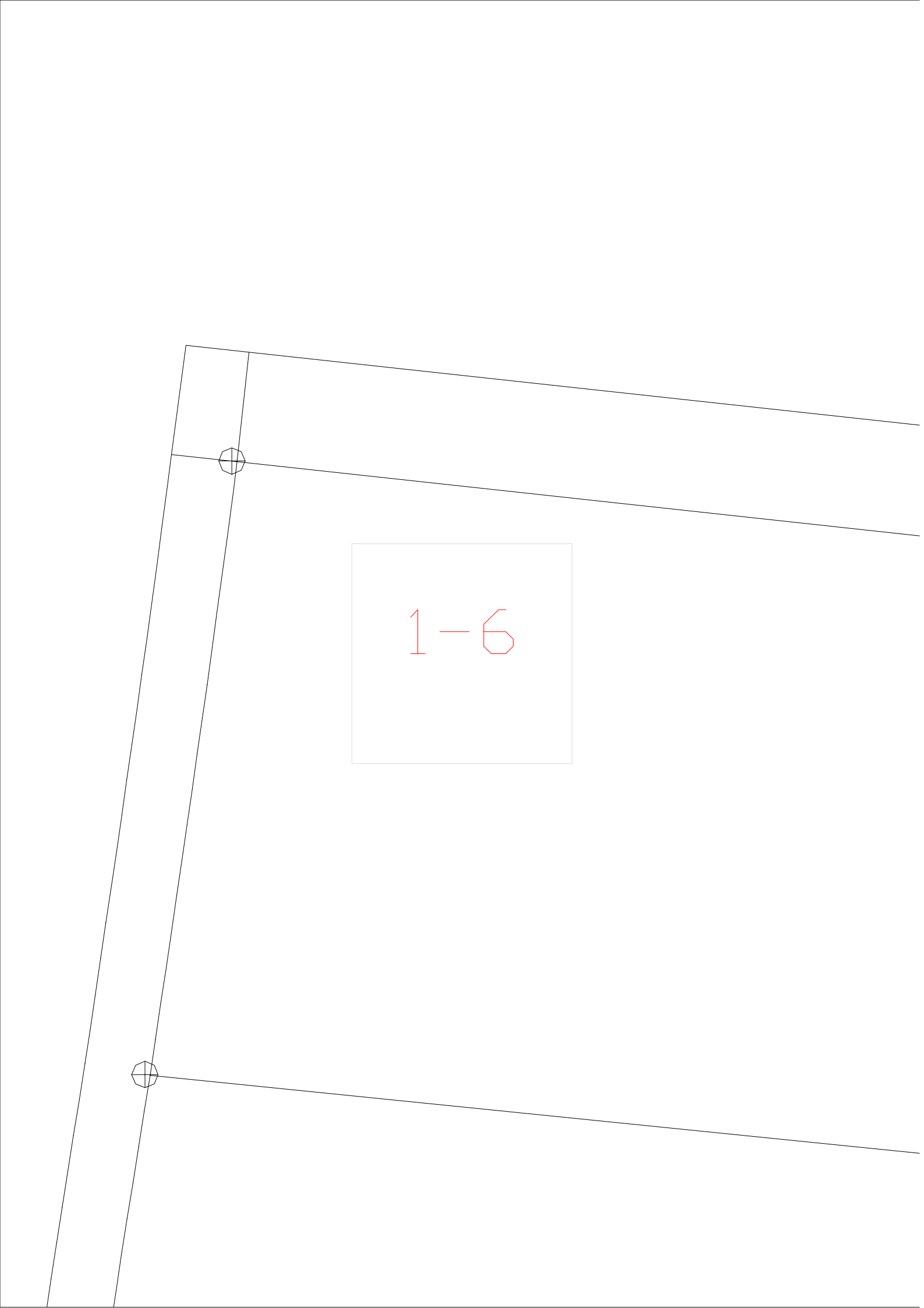

1-6

The image shows a technical drawing of a trapezoidal component. The component has a vertical left edge and a shorter vertical right edge. Two horizontal lines, representing top and bottom surfaces, connect the left and right edges. The top surface is slightly curved downwards. Two circular features, likely representing bolt heads, are positioned on the left edge. One is located near the top, and the other is near the bottom. A central rectangular area is highlighted with a light gray background and contains the red text '1-6'.

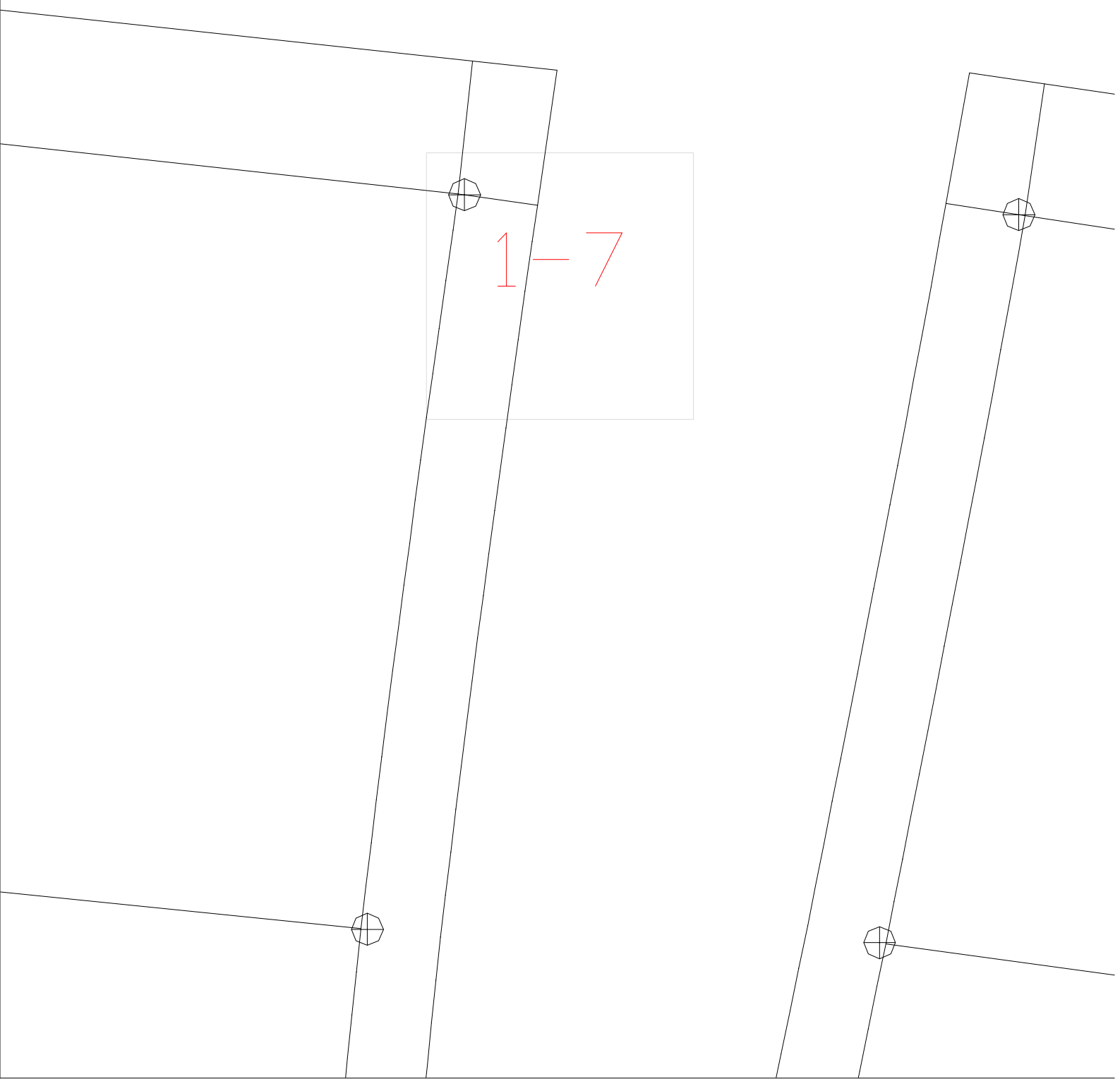

1-7

1-8

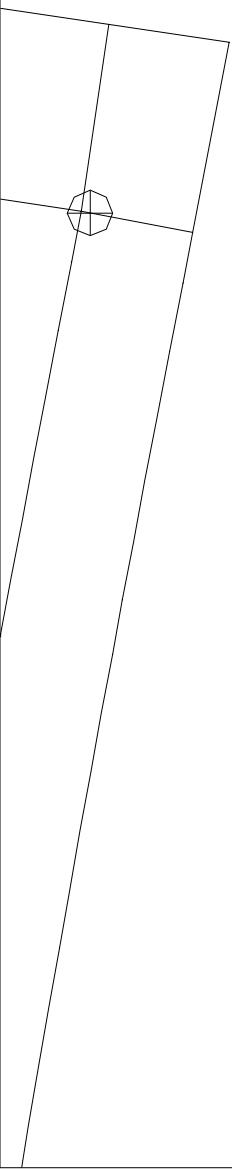

1-9

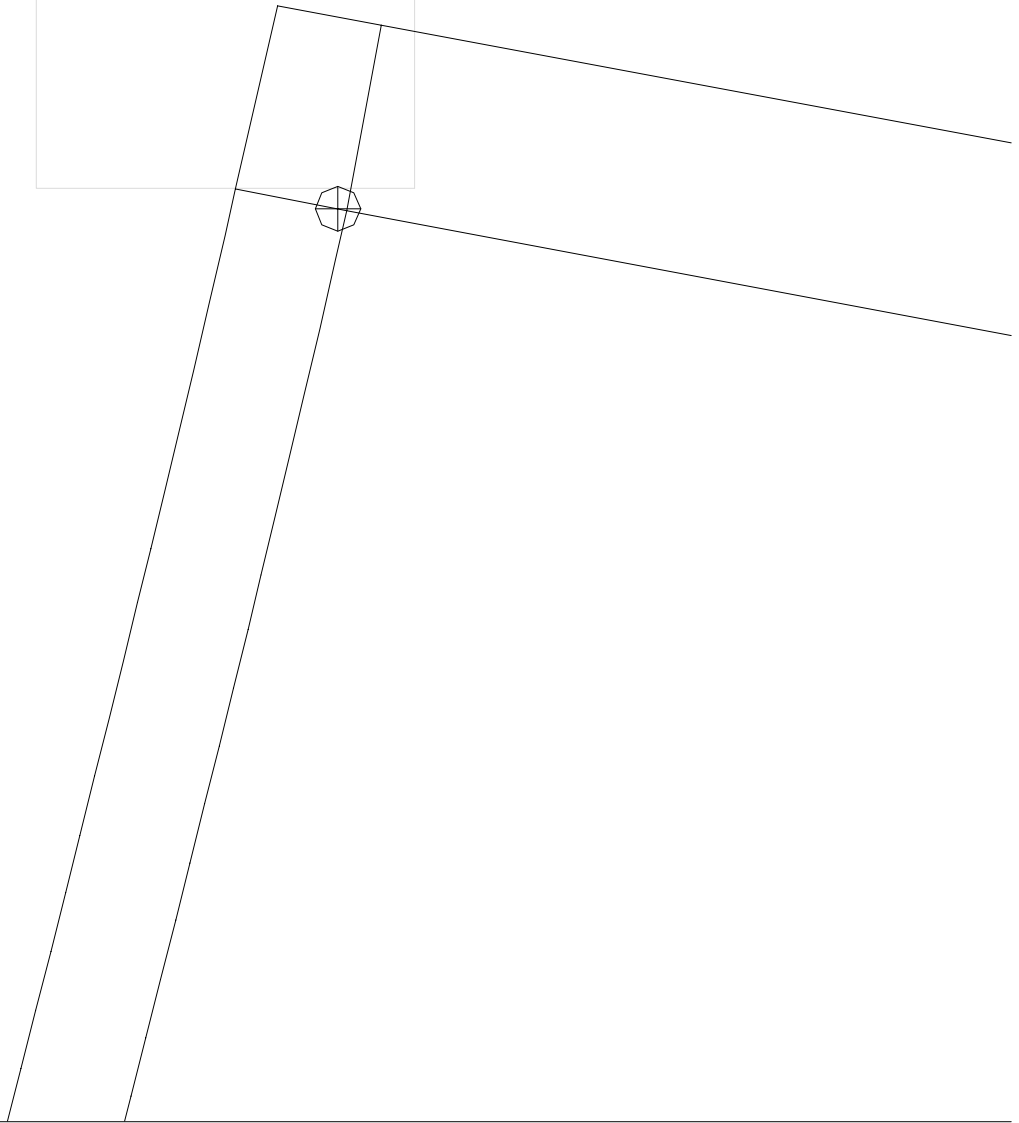

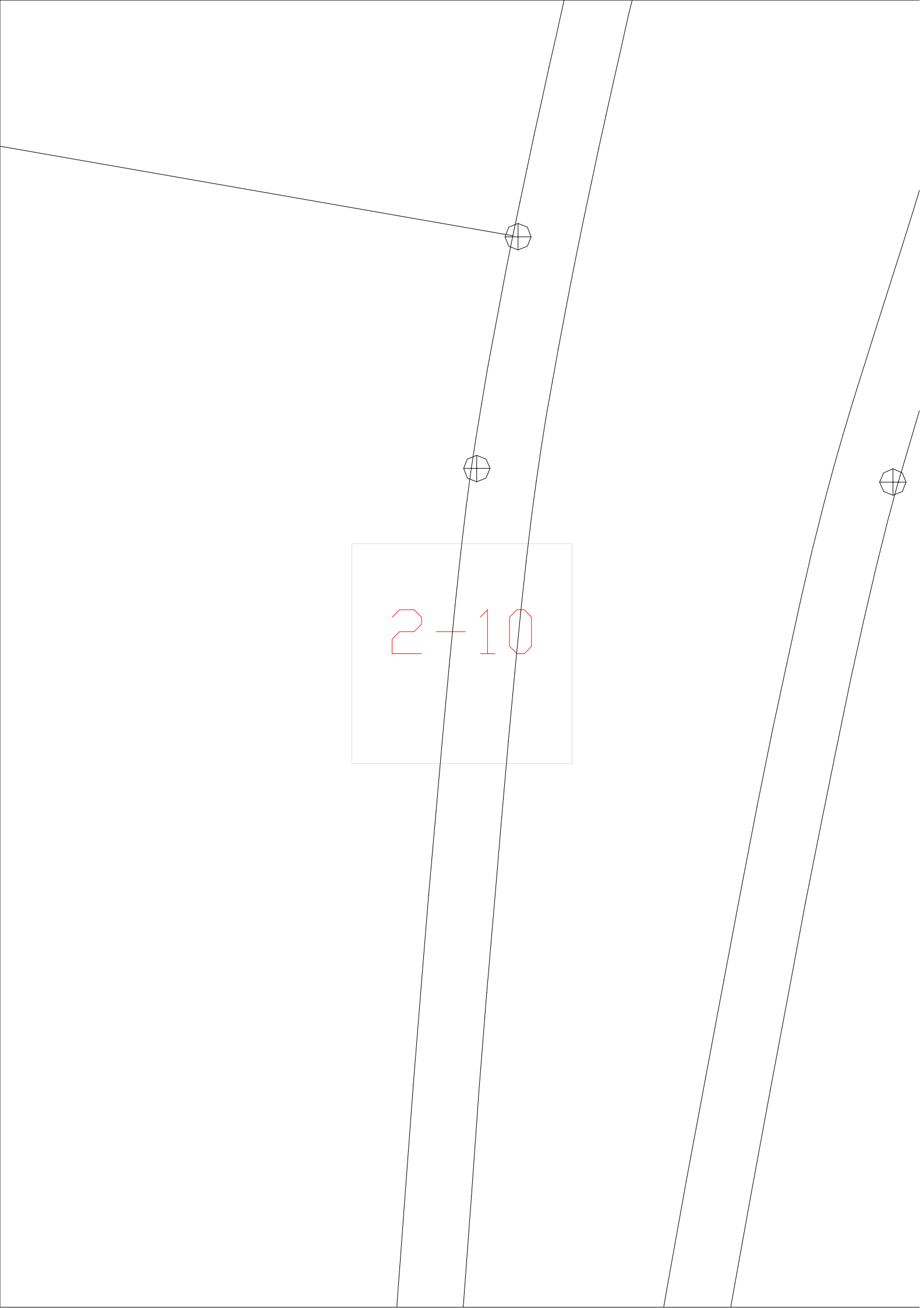

2-10

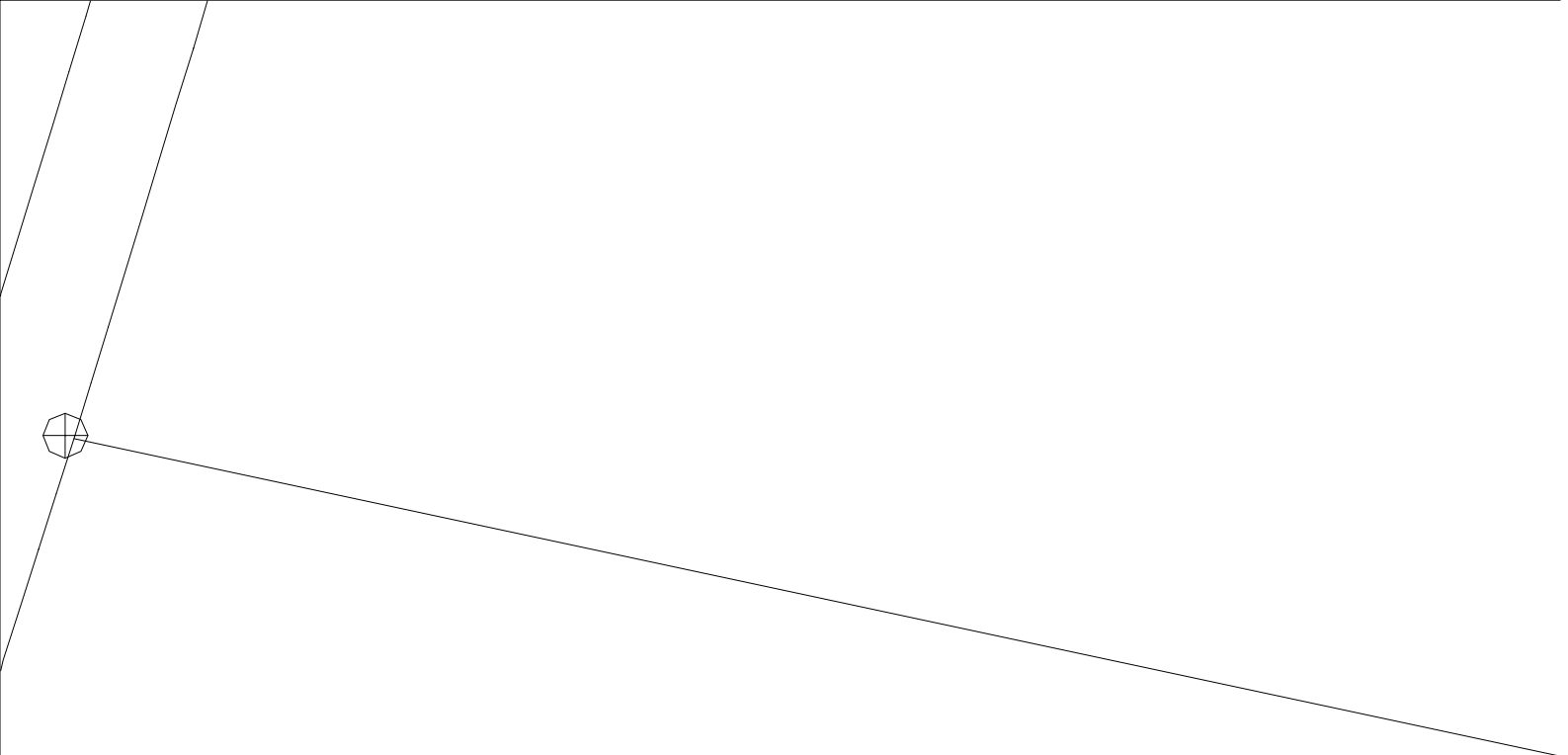

2-11

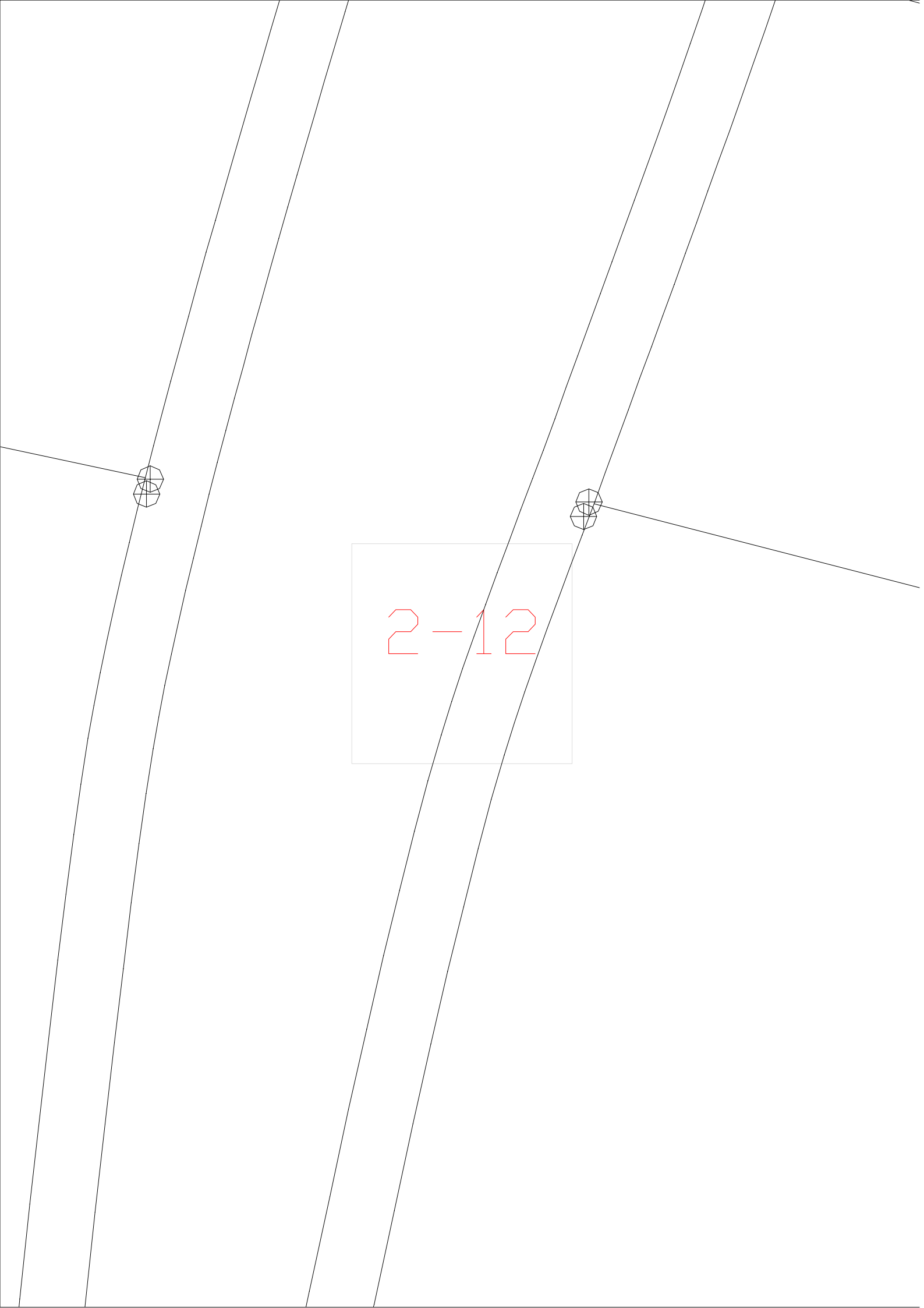

2-12

2-13

The image shows a technical drawing of a mechanical part. It features a central hole and a hole in the top flange. The part is shown in a perspective view. The central hole is a simple circle. The hole in the top flange is a circle with a cross inside, indicating it is a through-hole. The drawing is composed of several lines representing the edges and surfaces of the part. A light blue rectangular box highlights the central hole area, and the text '2-13' is written in red inside this box.

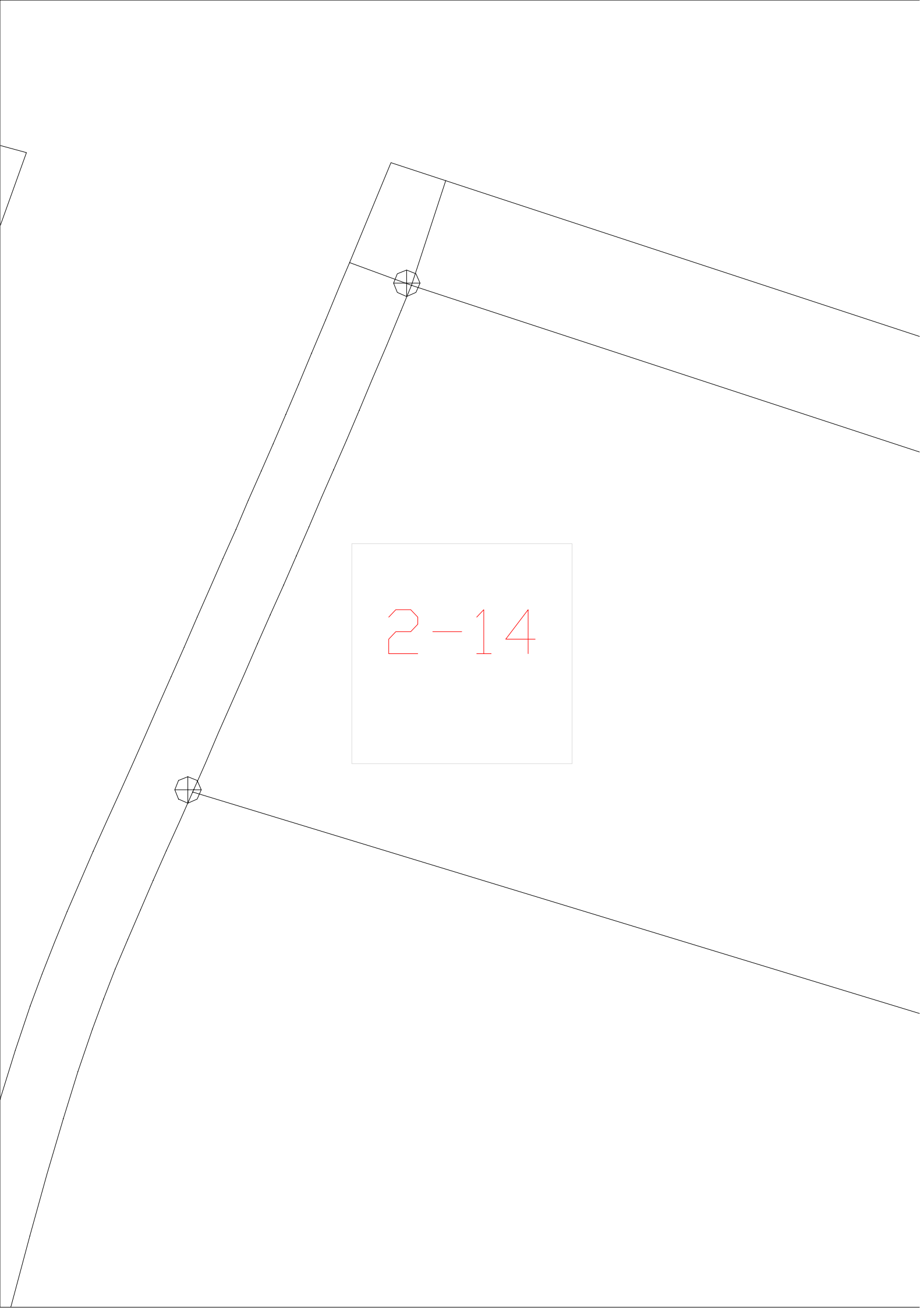

2-14

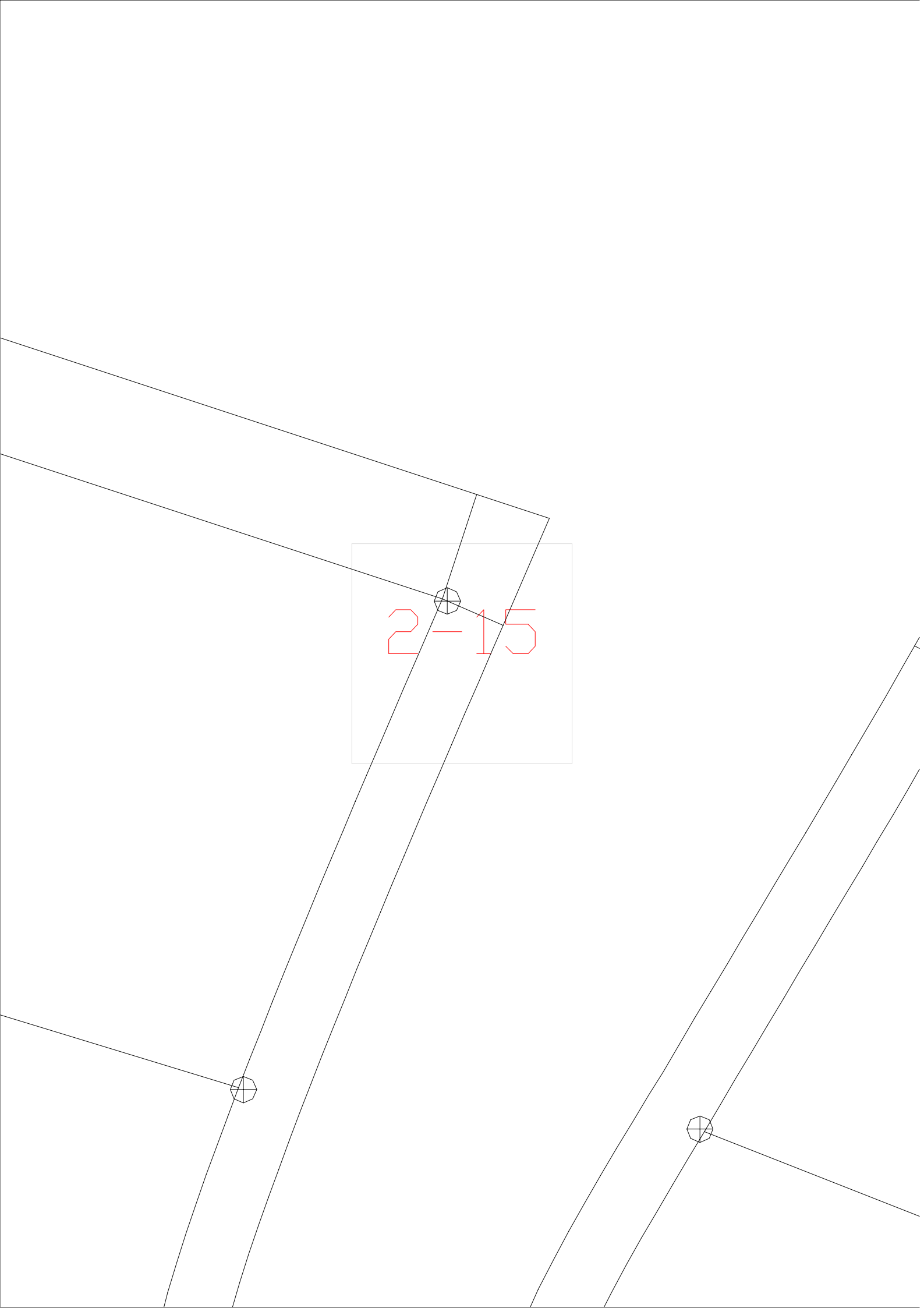

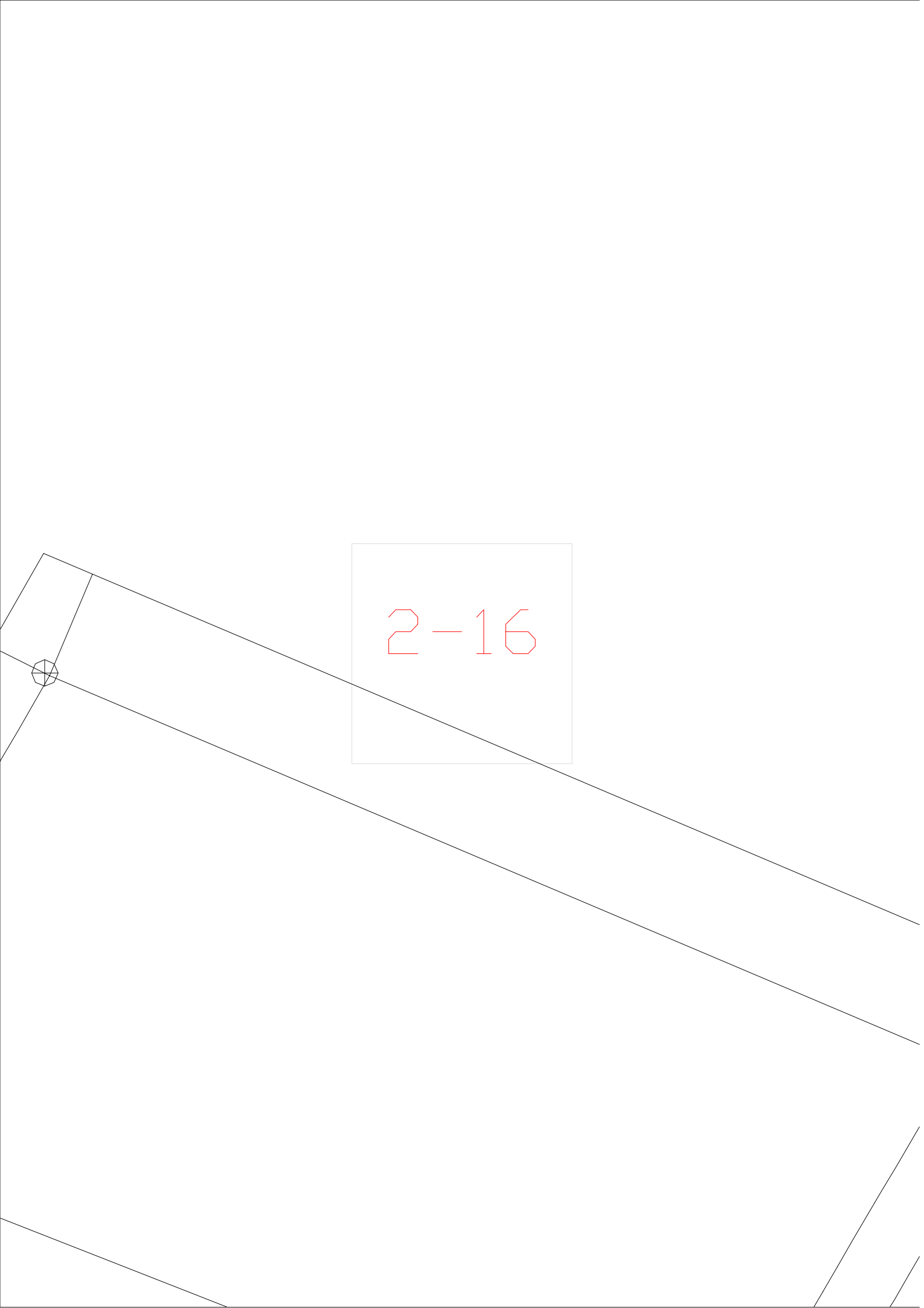

2-16

2-17

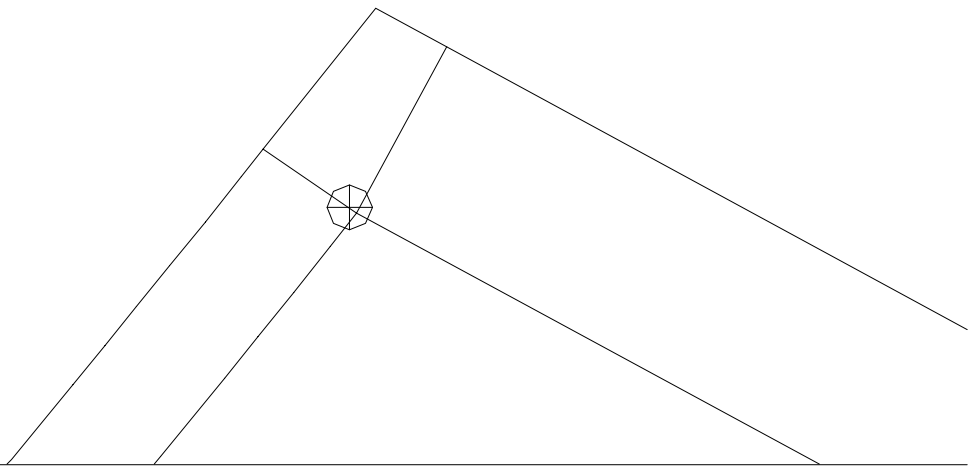
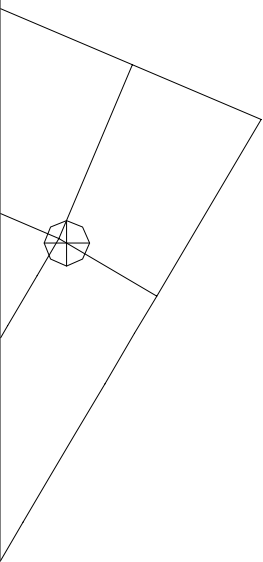

2-18

2-19



2-1

2-20

2-21

2-22

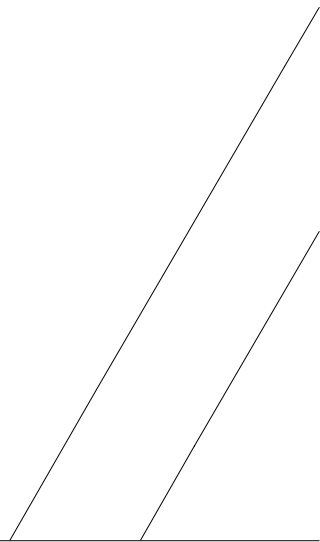

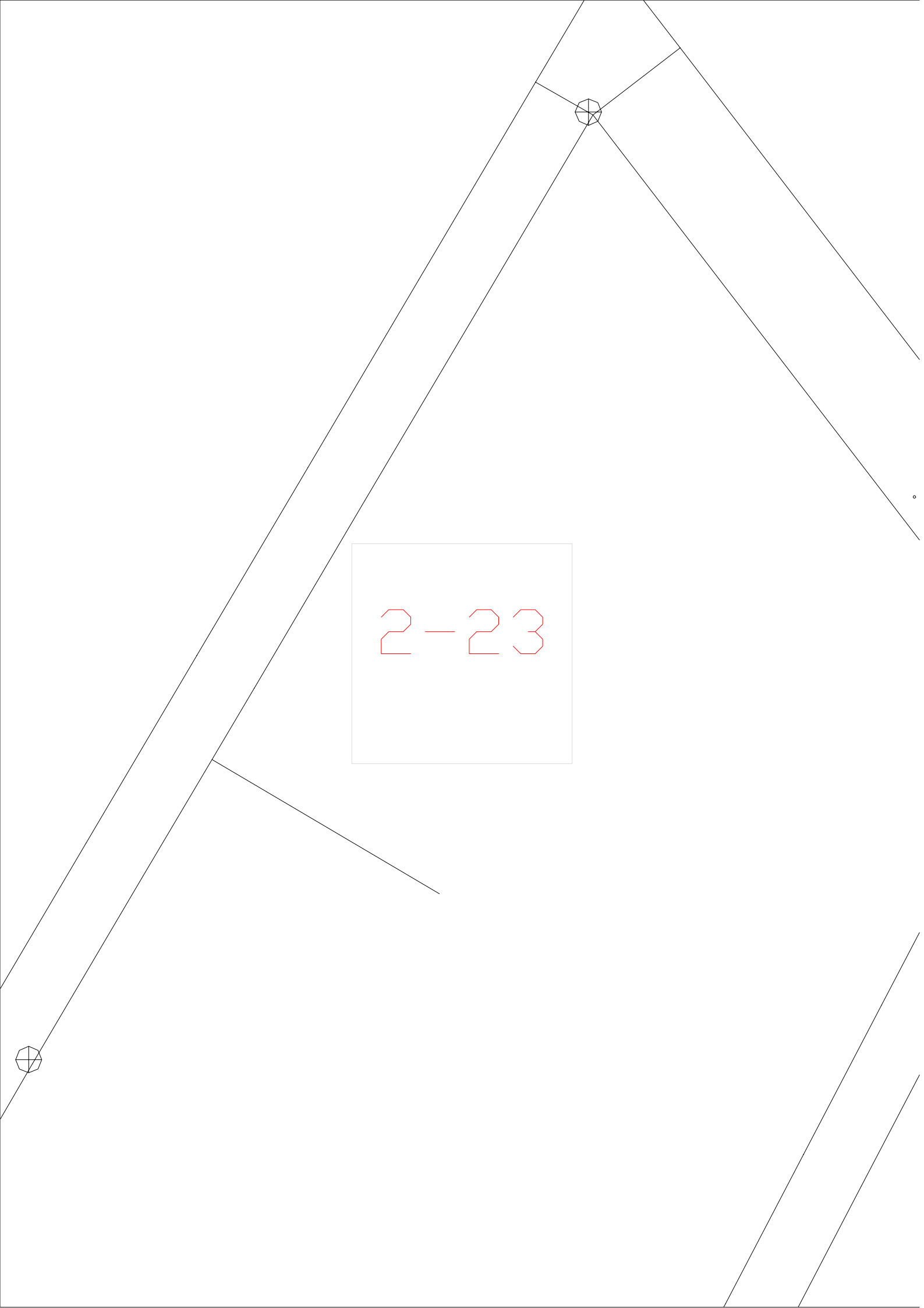

2-23

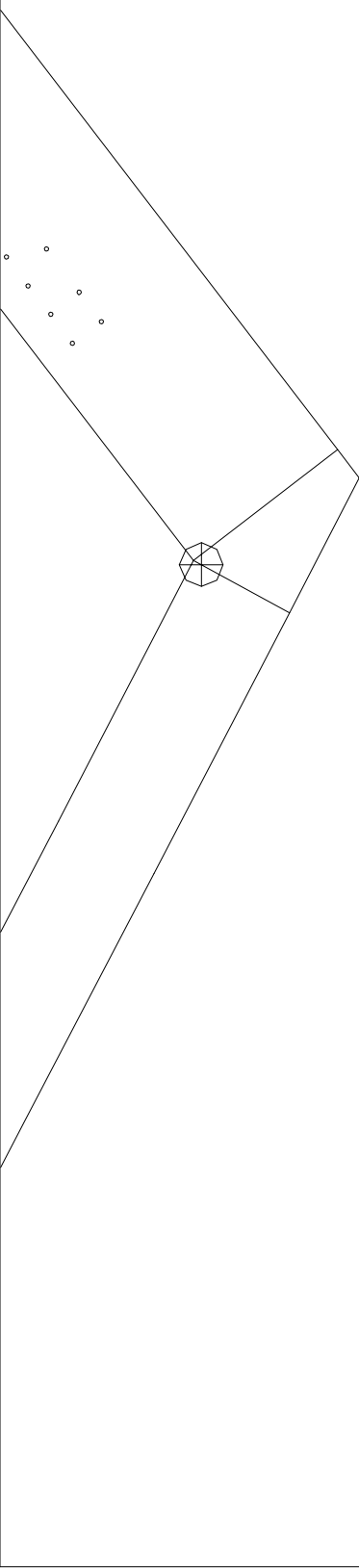

2-24

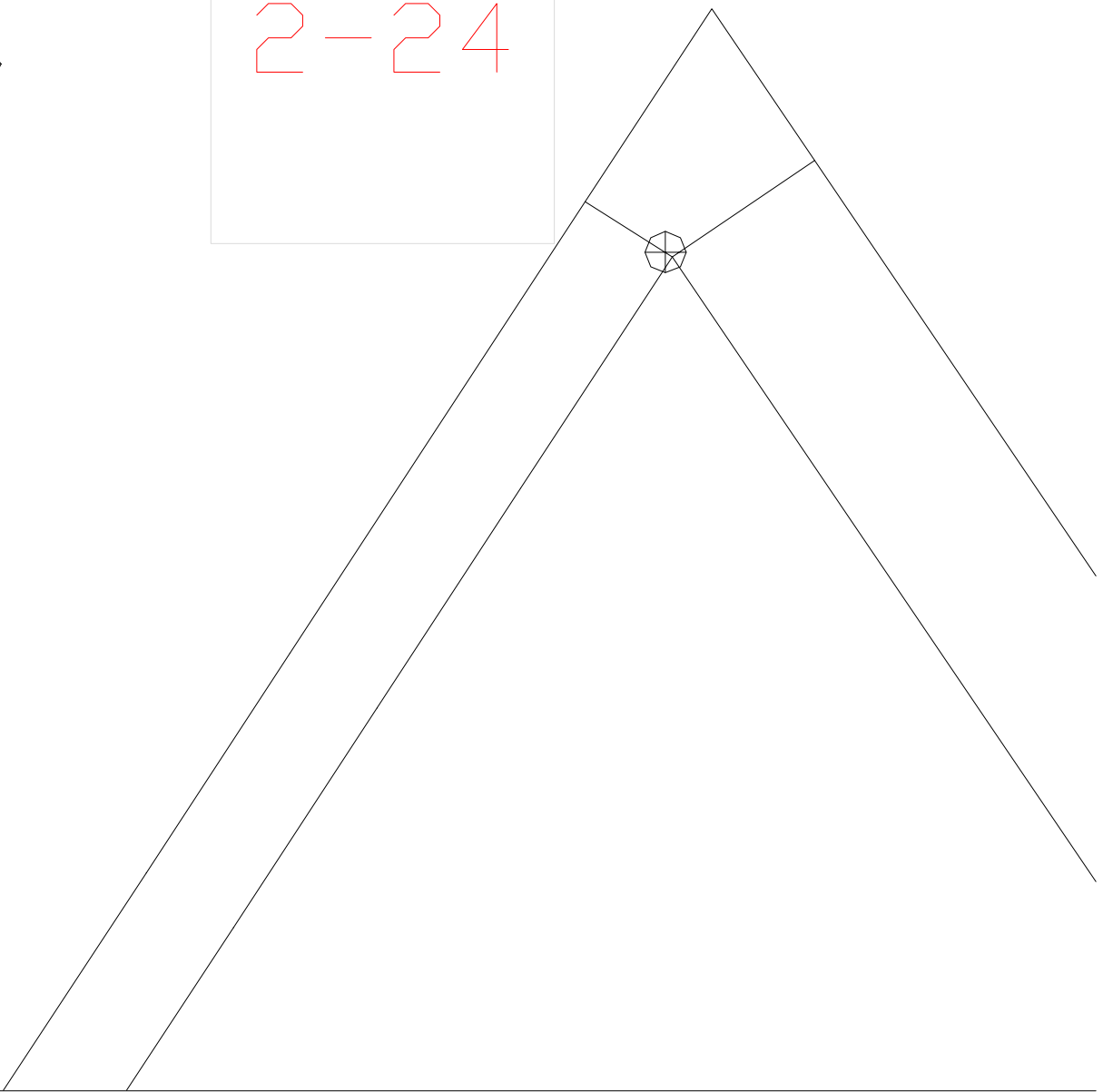

2-25

o
o
o
o
o
o
o
o
o
o



2-2

2-3

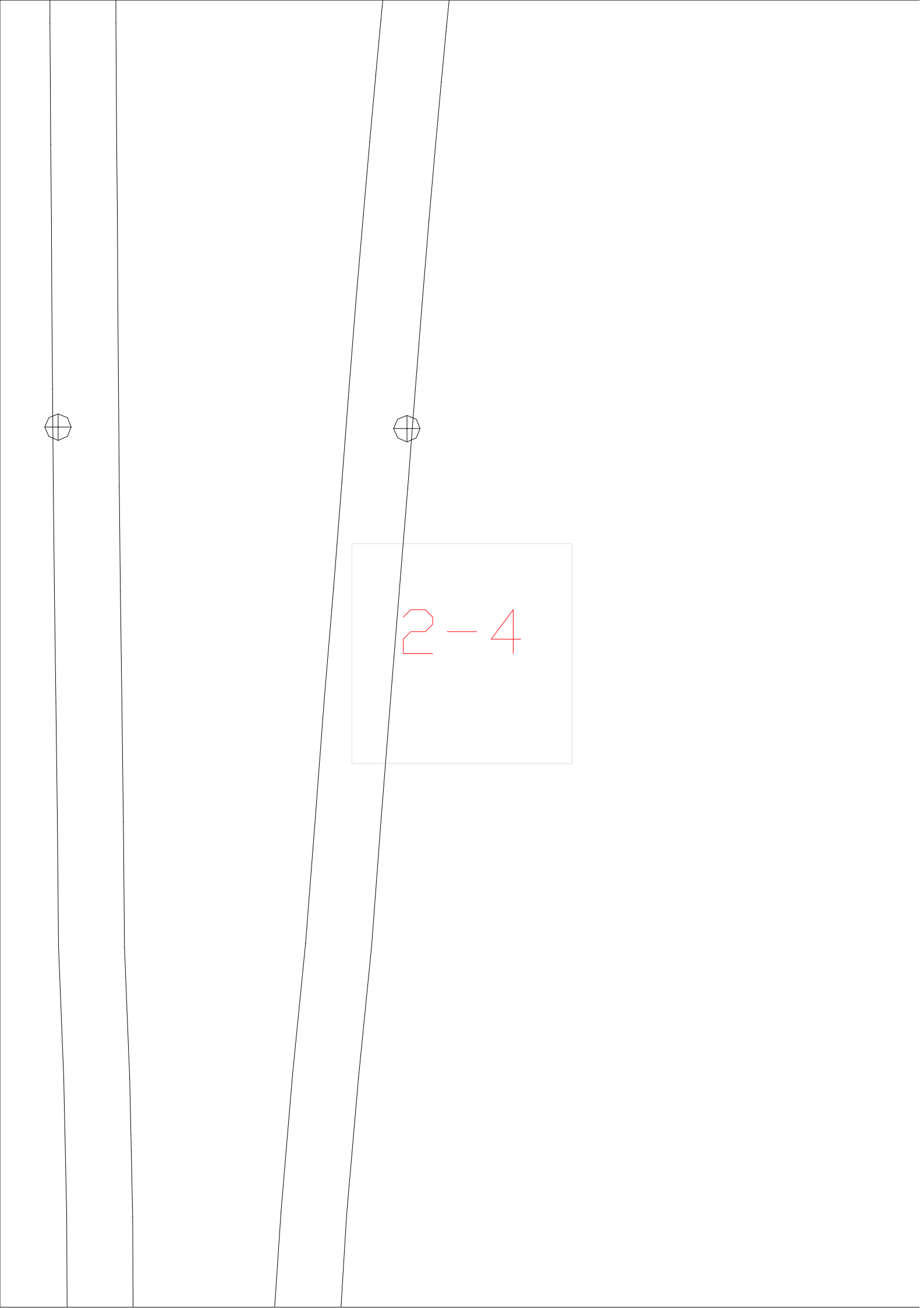

The diagram consists of several vertical lines. From left to right: a straight vertical line with a small circle containing a cross; a slightly curved vertical line; a pair of parallel lines that are slightly slanted to the right, with a small circle containing a cross between them; and a final straight vertical line.

2-4

2-5





2-6



2-7

2-8

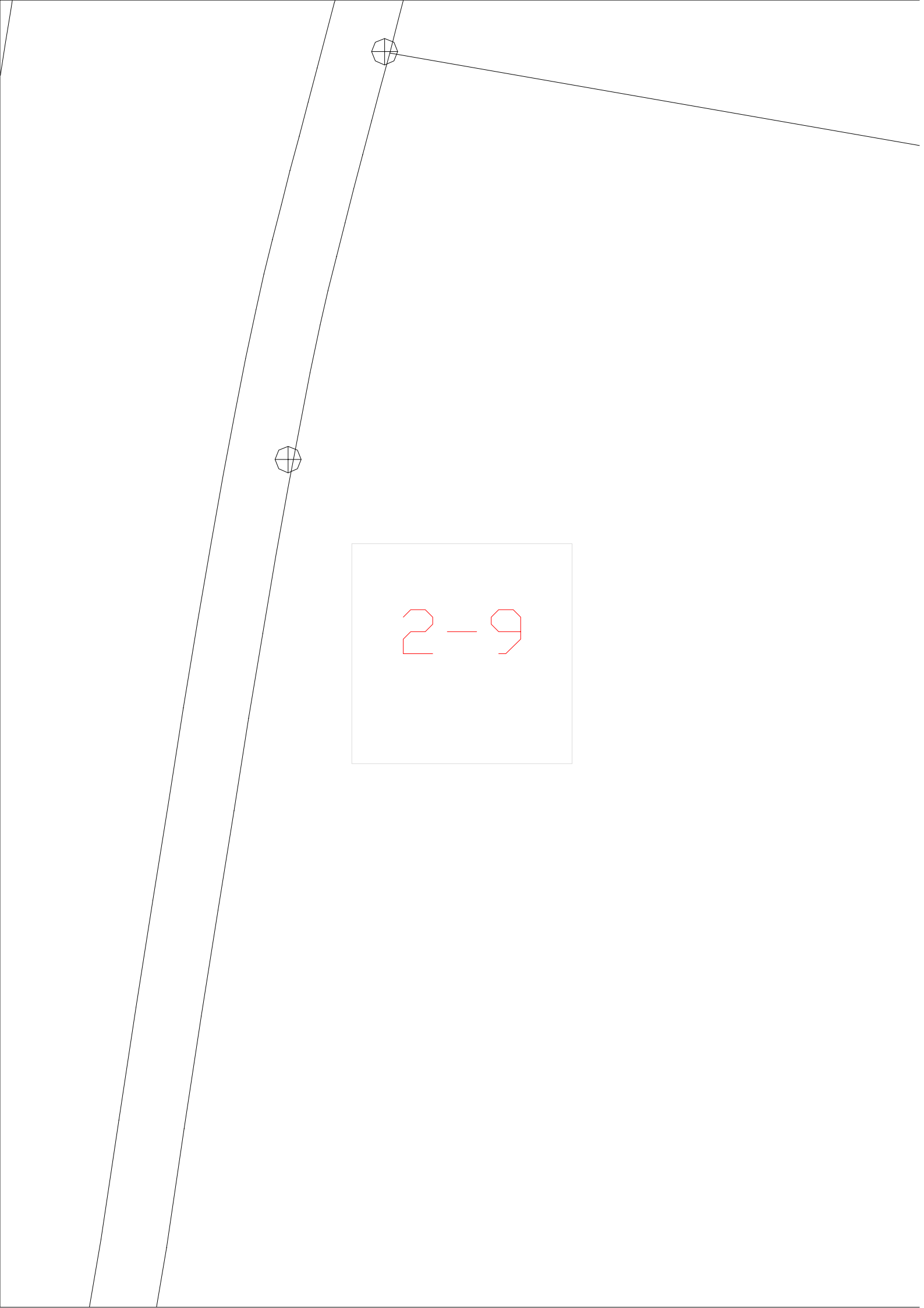

2-9



3-10

3-11

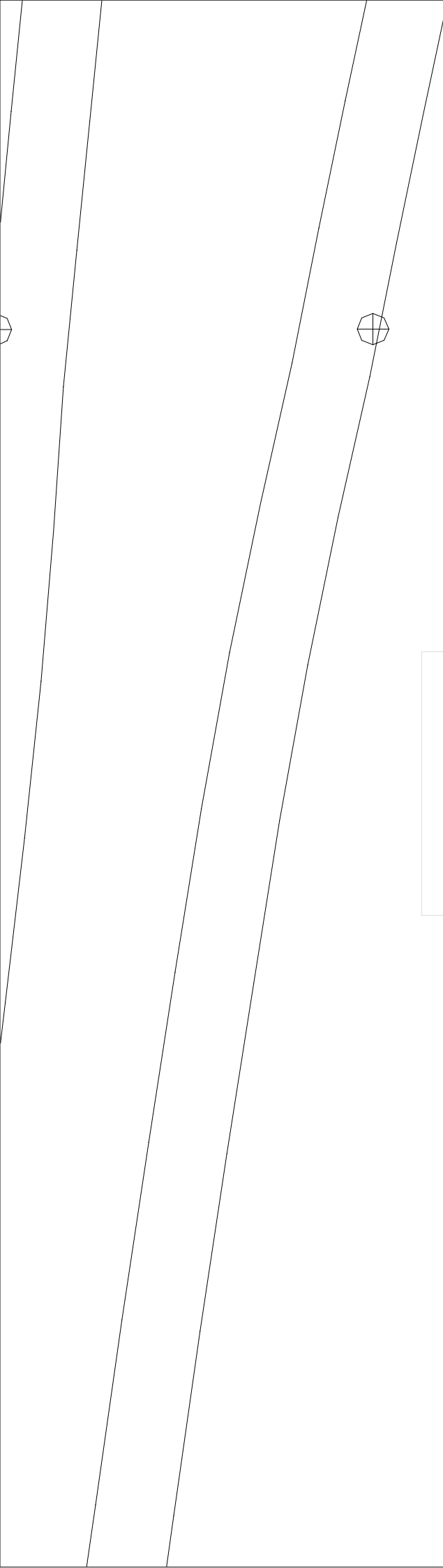

3-12

3-13



3-14



3-15

3-16

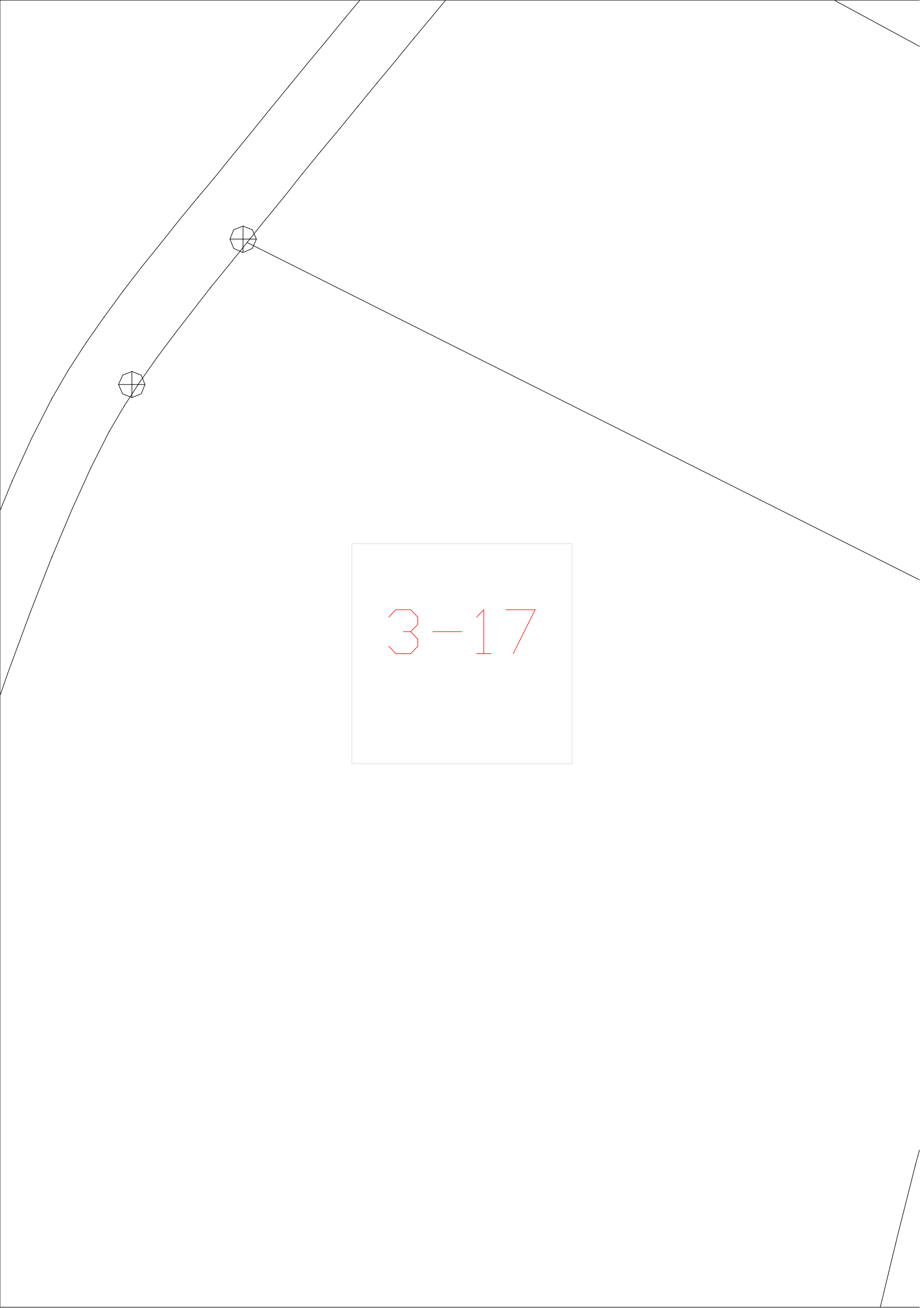

3-17

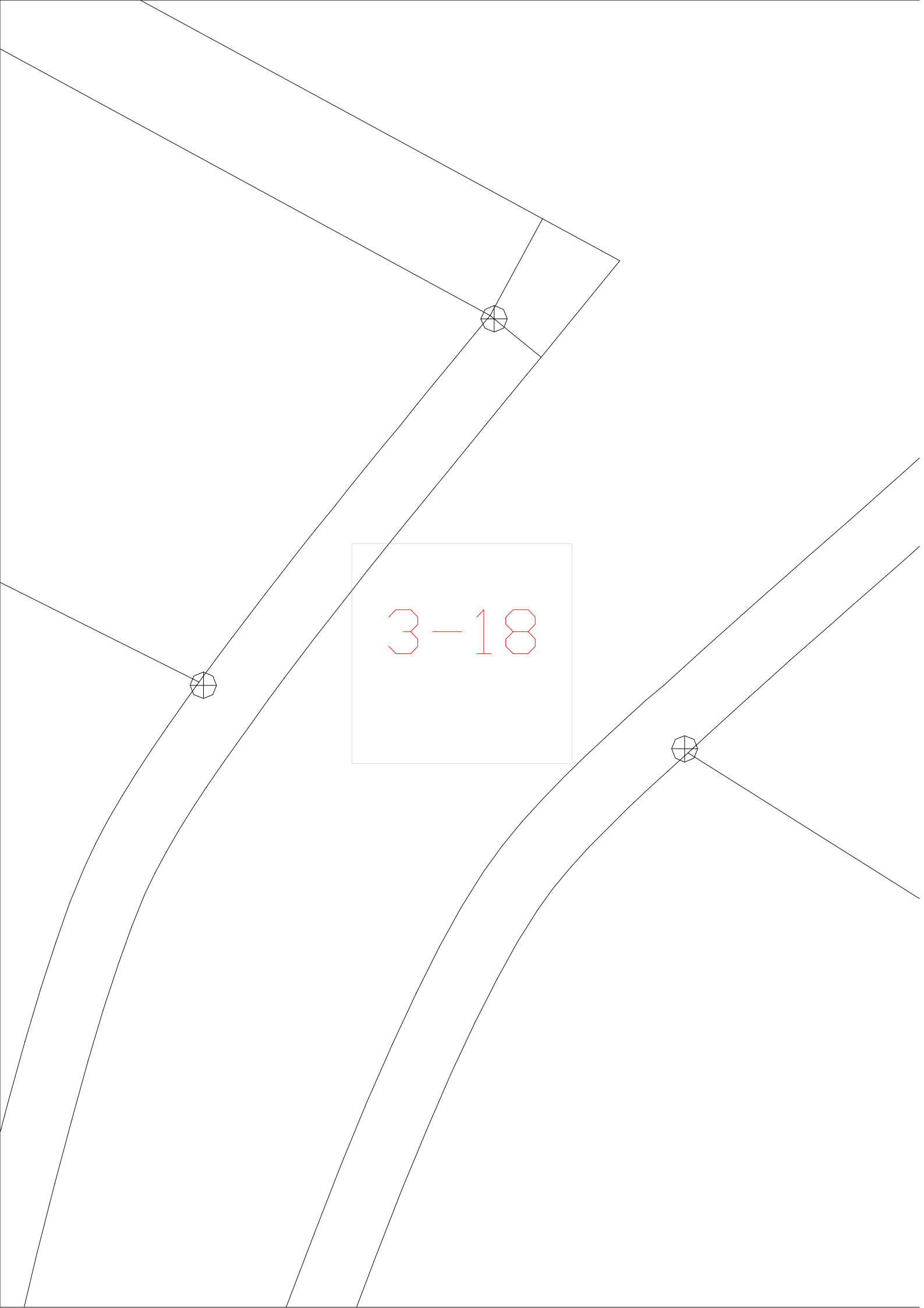

3-18

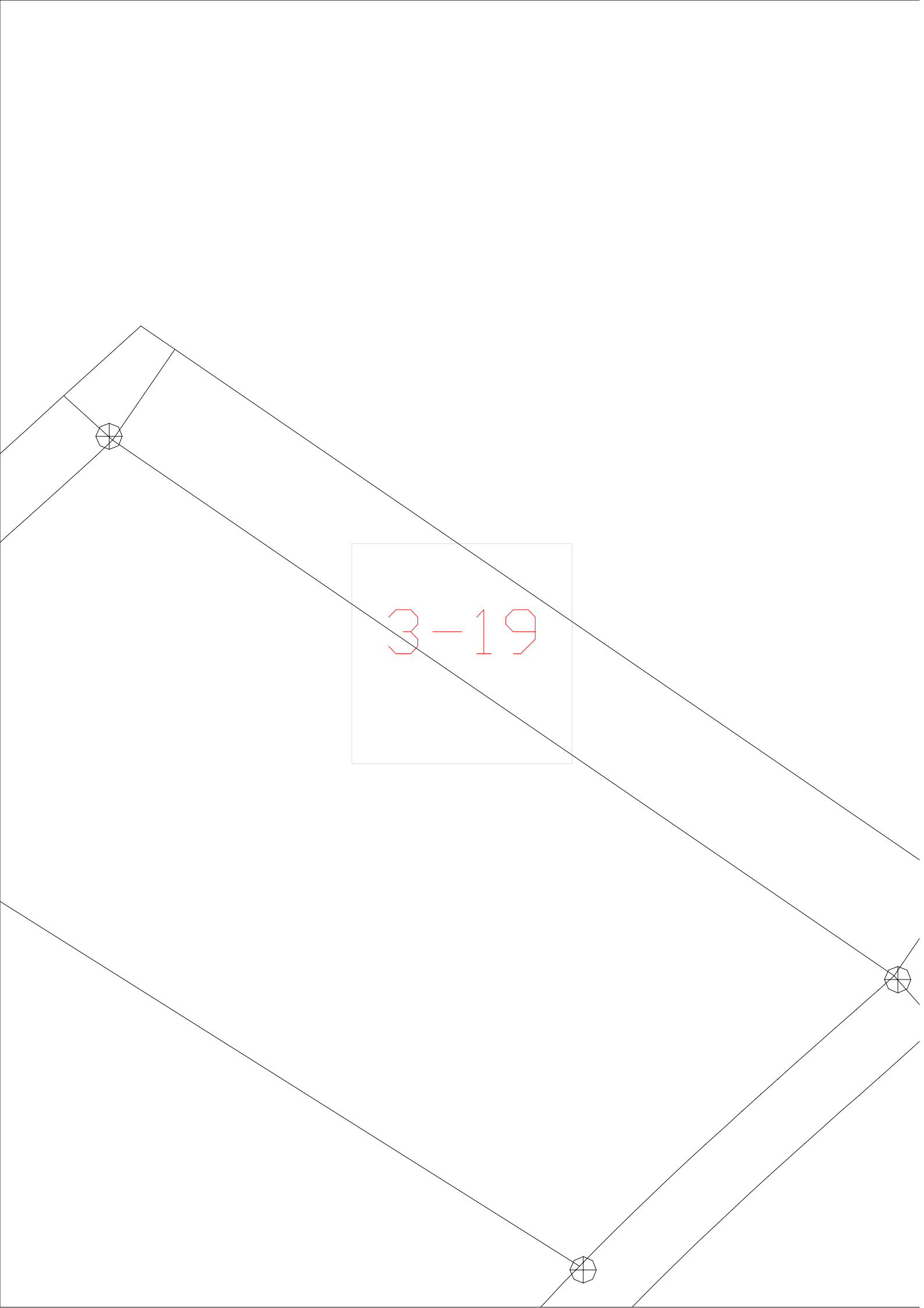

3-19



3-1

3-20

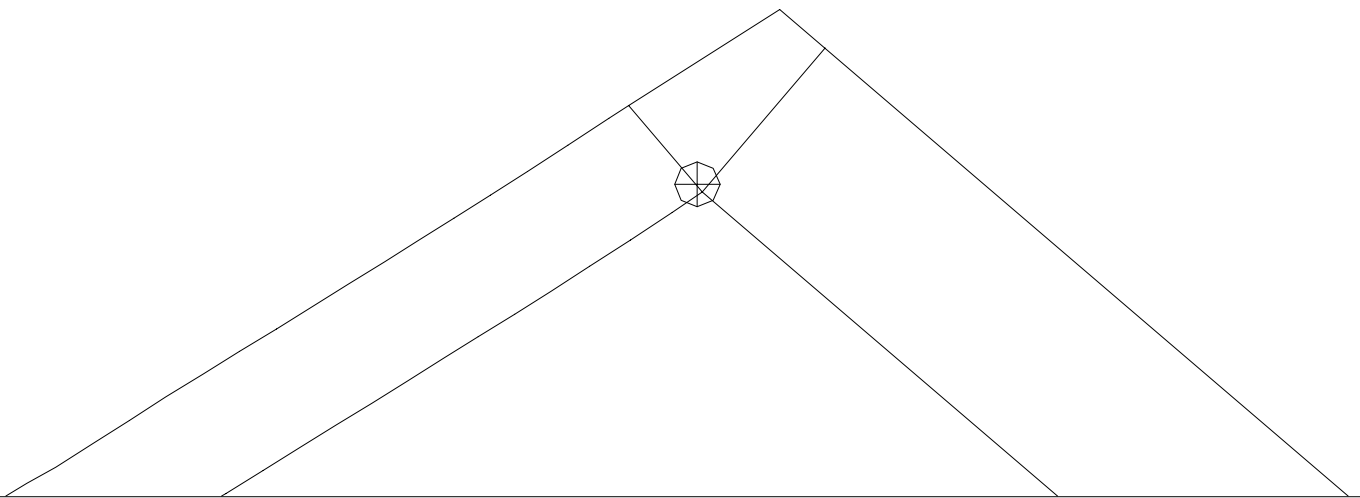
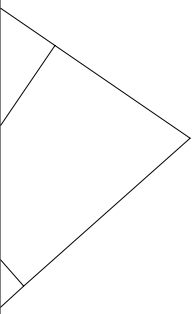

3-21

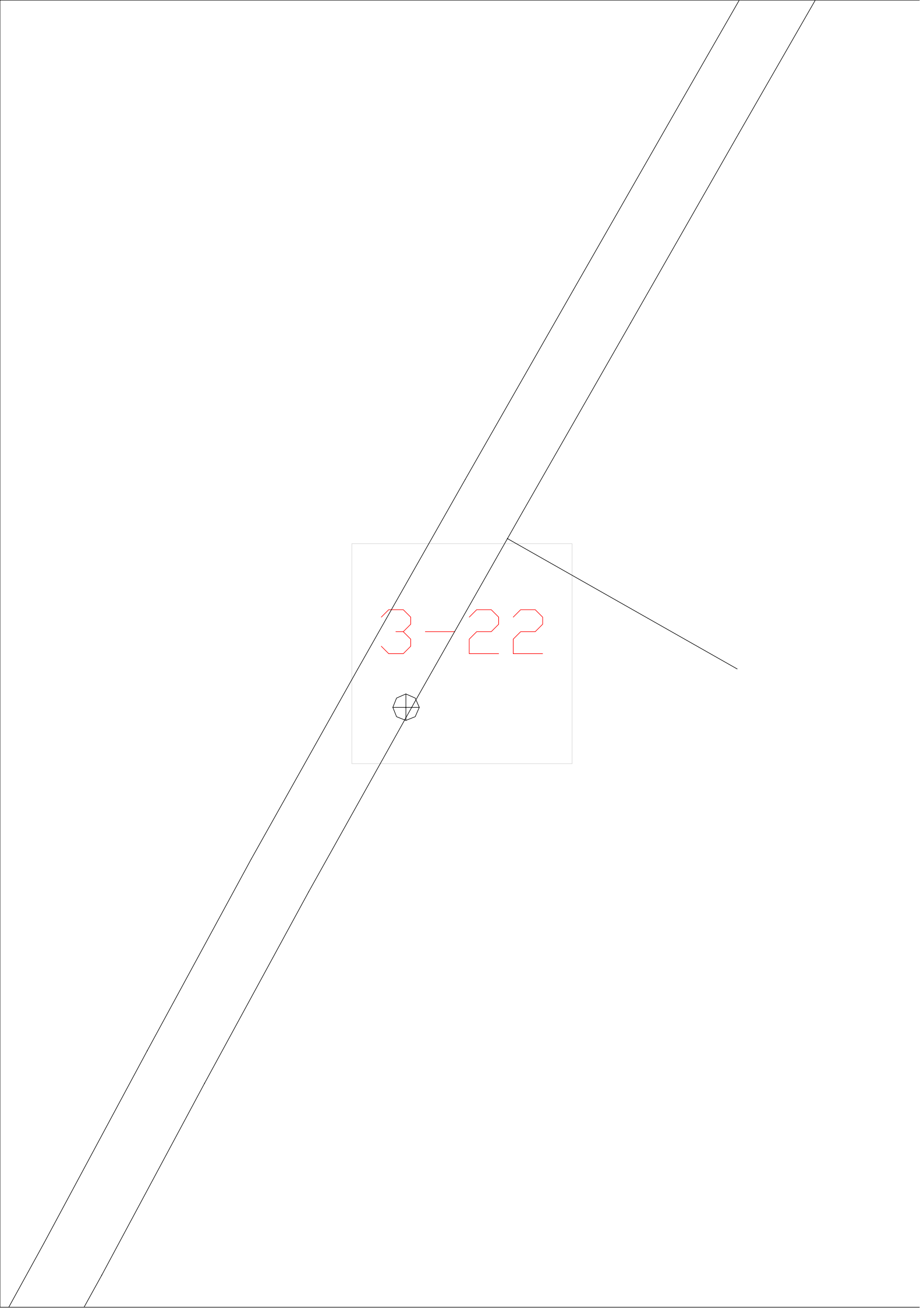

3-22



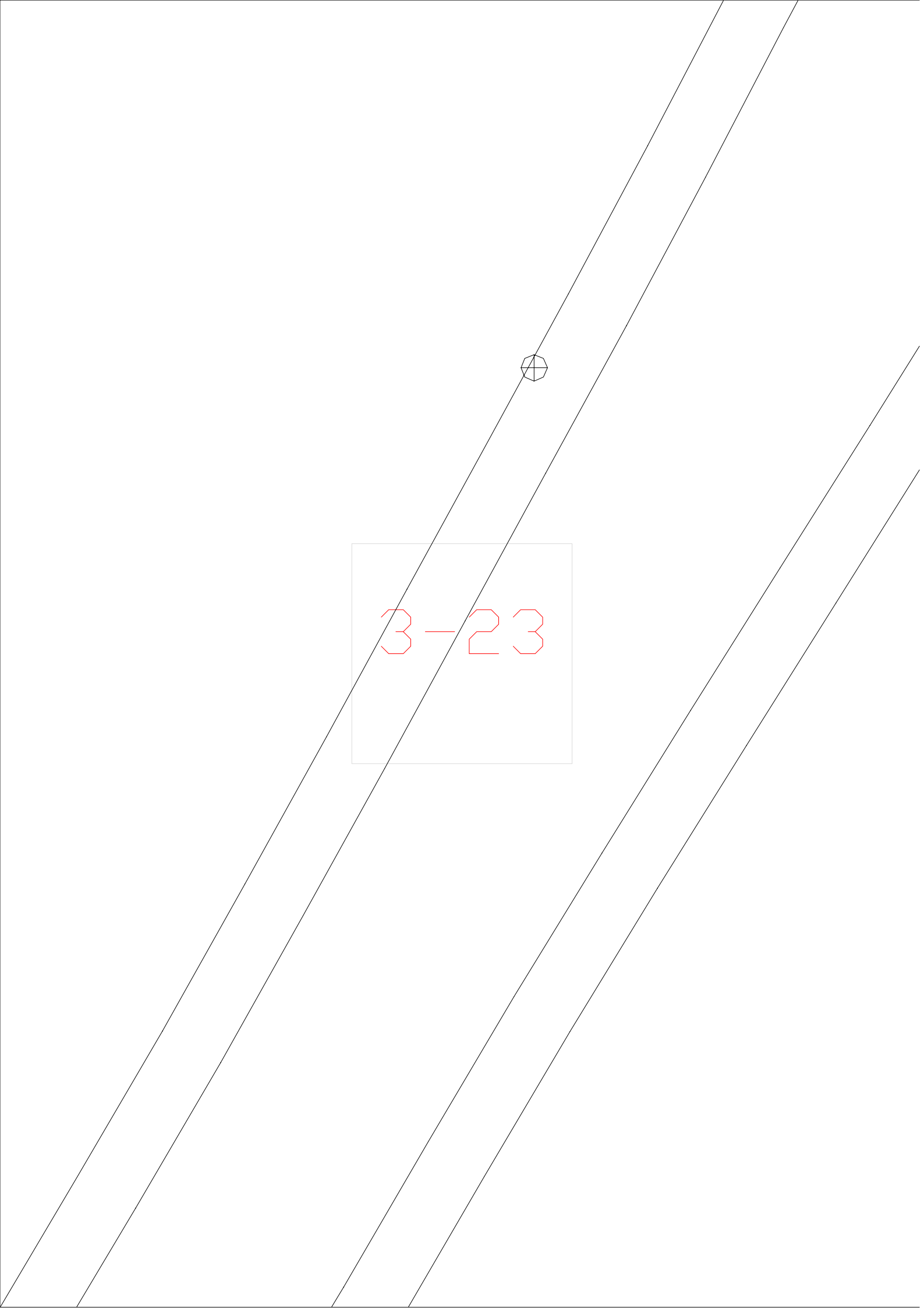

3-23

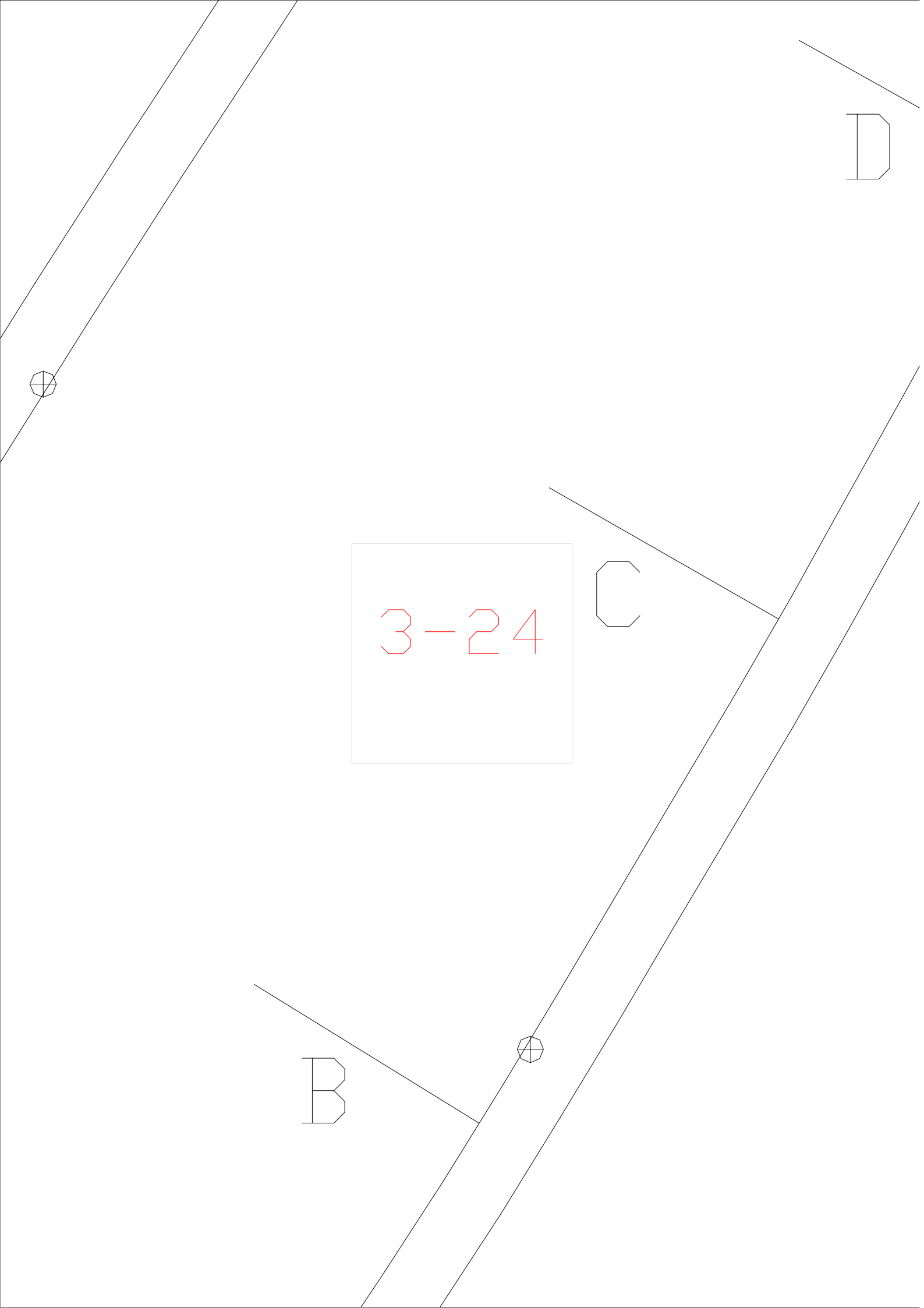

3-24

C

B

D

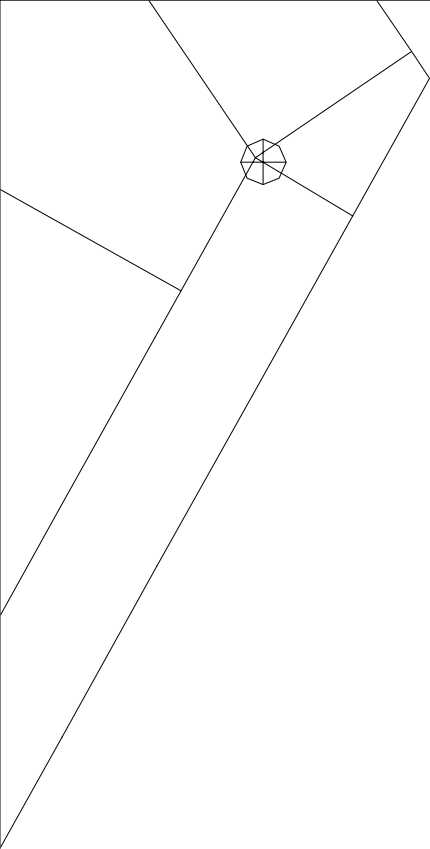

3-25



3-2

3-3



3-4

3-5



3-6



3-7

3-8





3-9

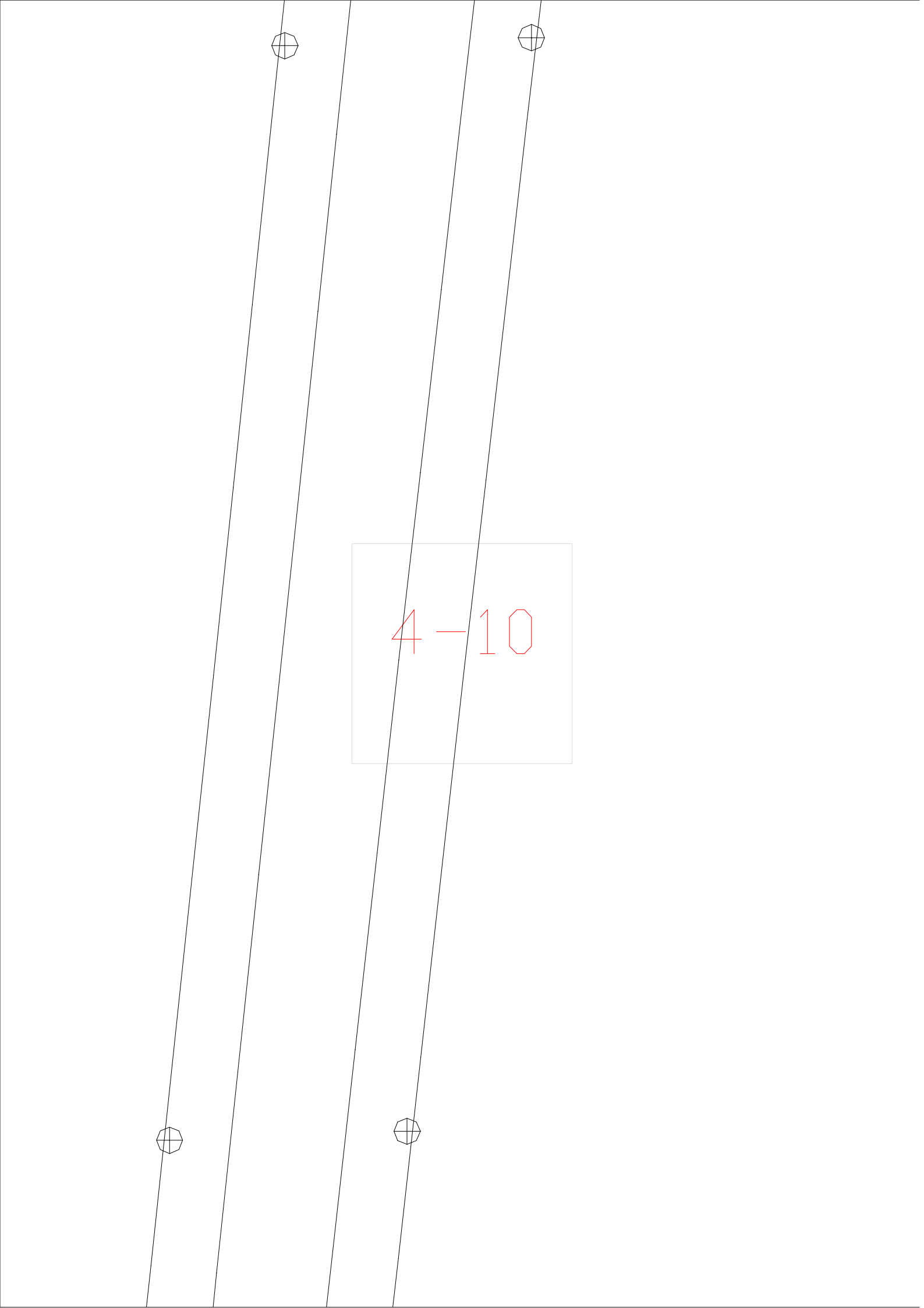

The diagram consists of four vertical lines. On the first and third lines from the left, there are circles with a cross inside, one near the top and one near the bottom. On the second and fourth lines, there are circles with a cross inside, both near the top. A light blue rectangular box is centered in the middle of the diagram, containing the equation $4 - 10$ in red text.

$$4 - 10$$

4-11





4-12

4-13

$$4 - 14$$



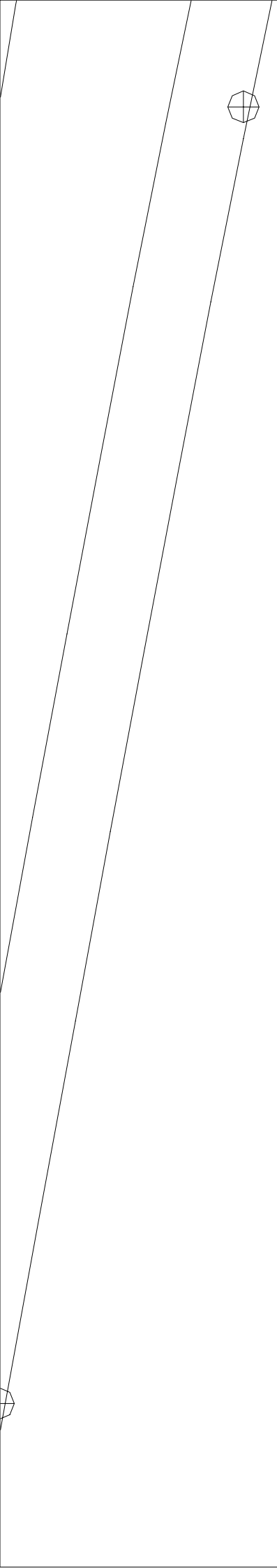

4-15

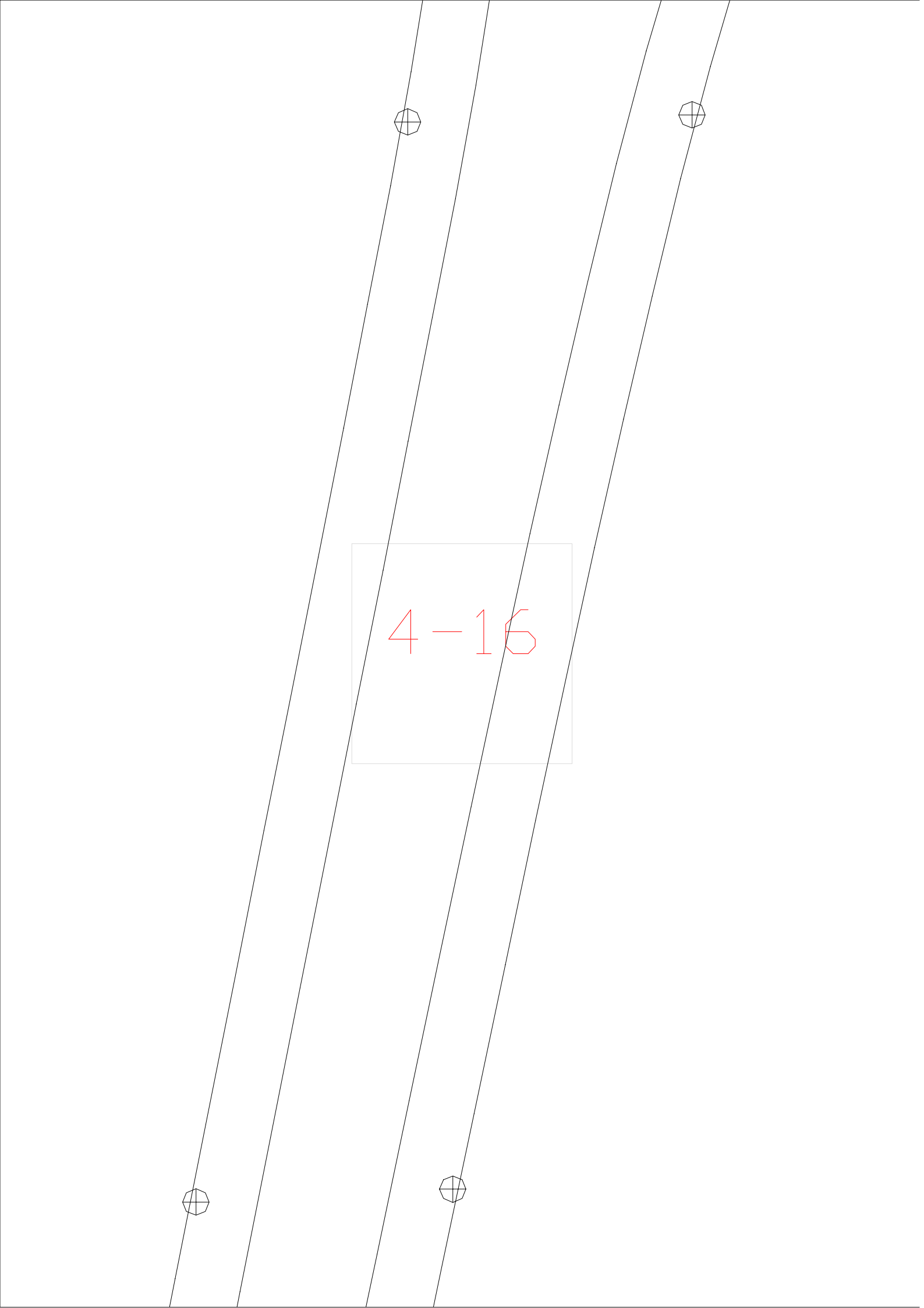

The diagram consists of four parallel lines slanted from bottom-left to top-right. On each line, there is a small circle with a cross inside. A light gray rectangular box is centered in the space between the second and third lines from the left. Inside this box, the text "4-16" is written in red.

4-16

4-17





4-18

4-19

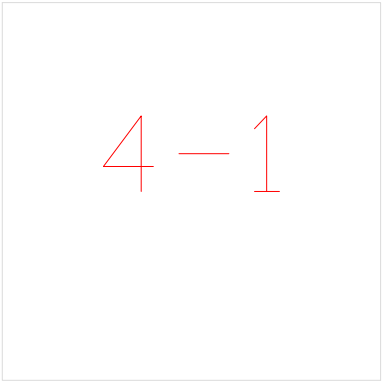
$$4 - 1$$

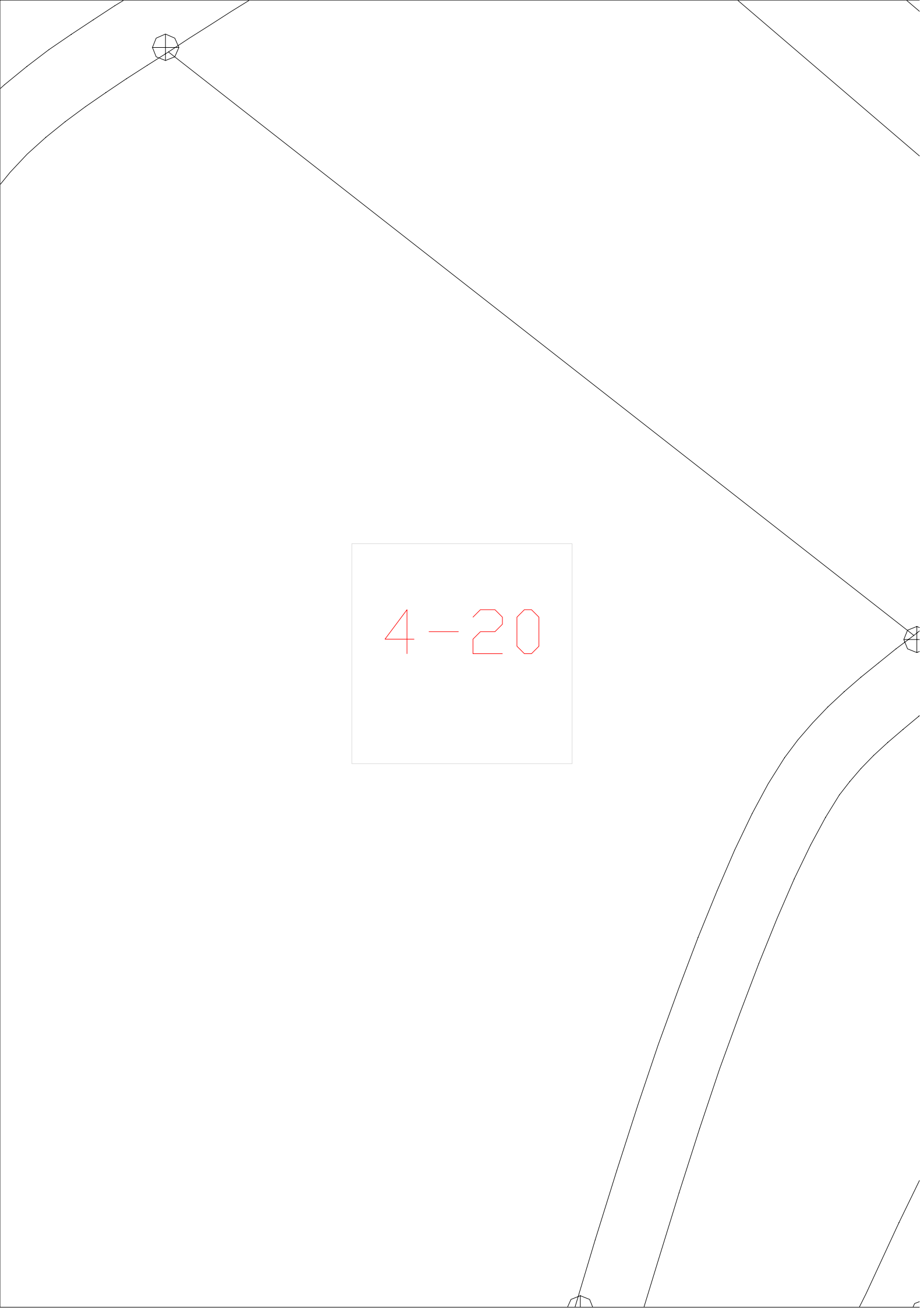

4-20

The image shows a technical drawing of a dome structure. The dome is represented by a series of curved lines that meet at a central point at the top. There are four small circular symbols, each with a cross inside, located at the top, bottom, and two side positions, likely representing rivets or bolts. A central rectangular box contains the text '4-20' in red. The drawing is a line drawing with no shading or color, except for the red text.

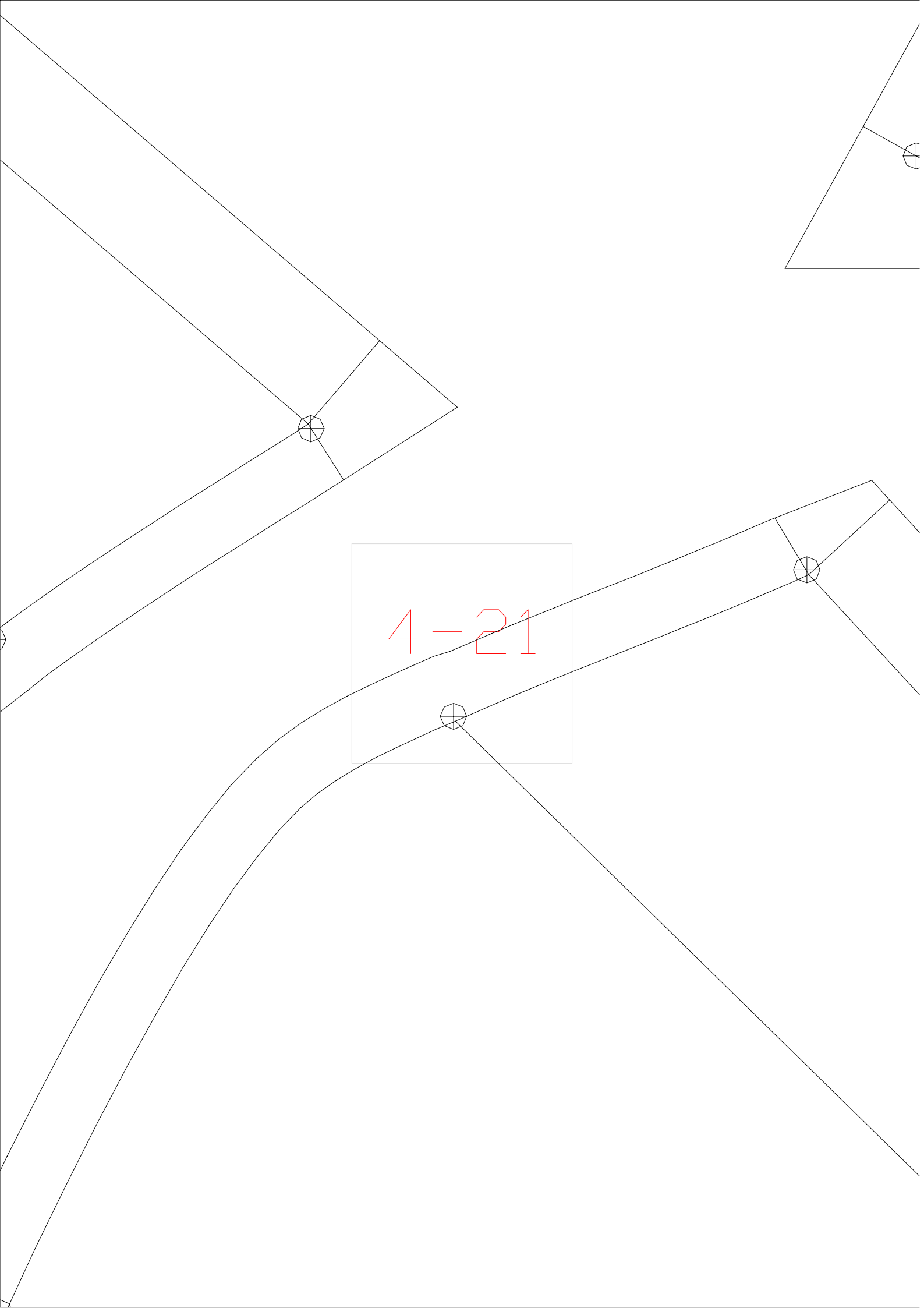

4-21

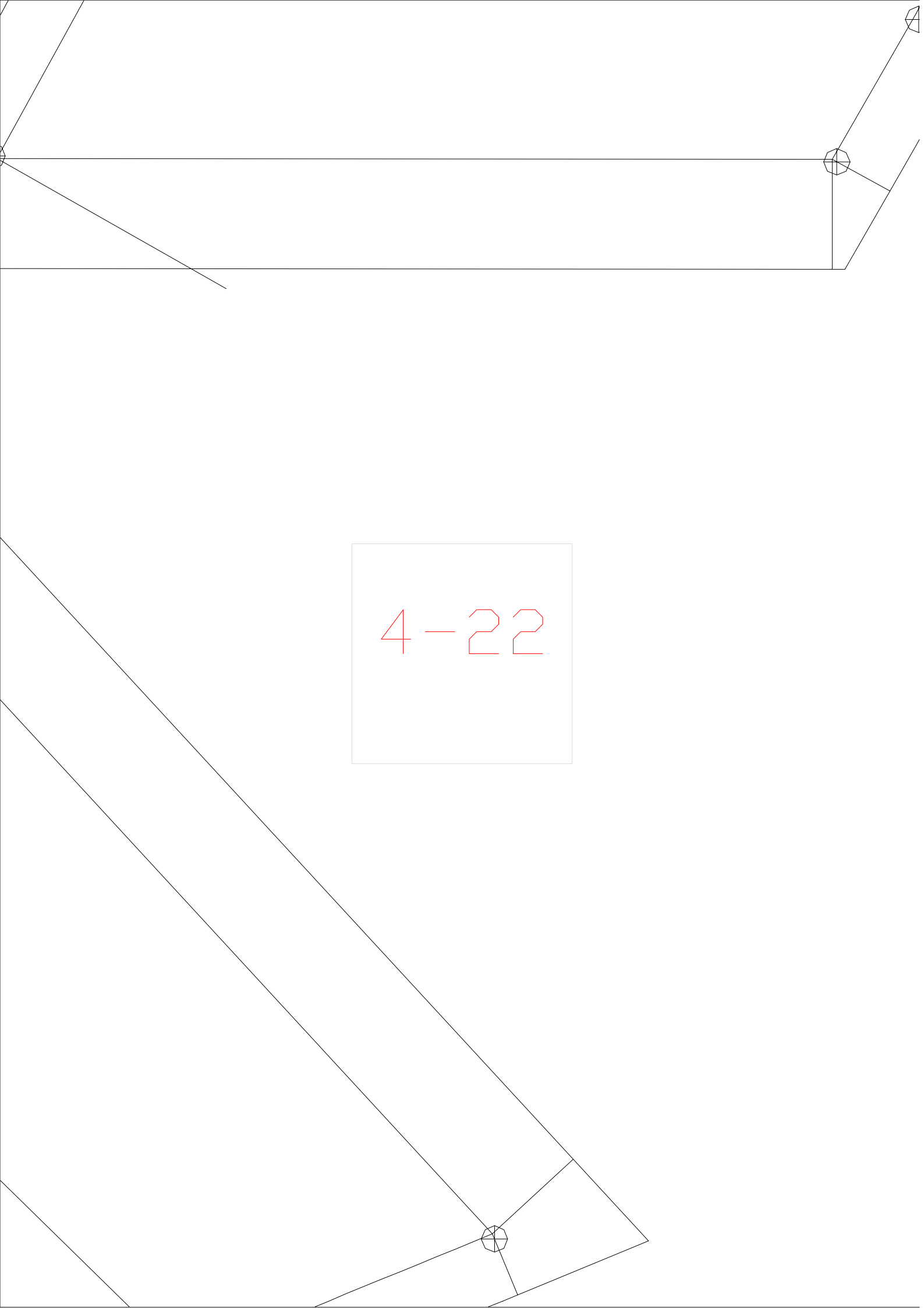

4-22

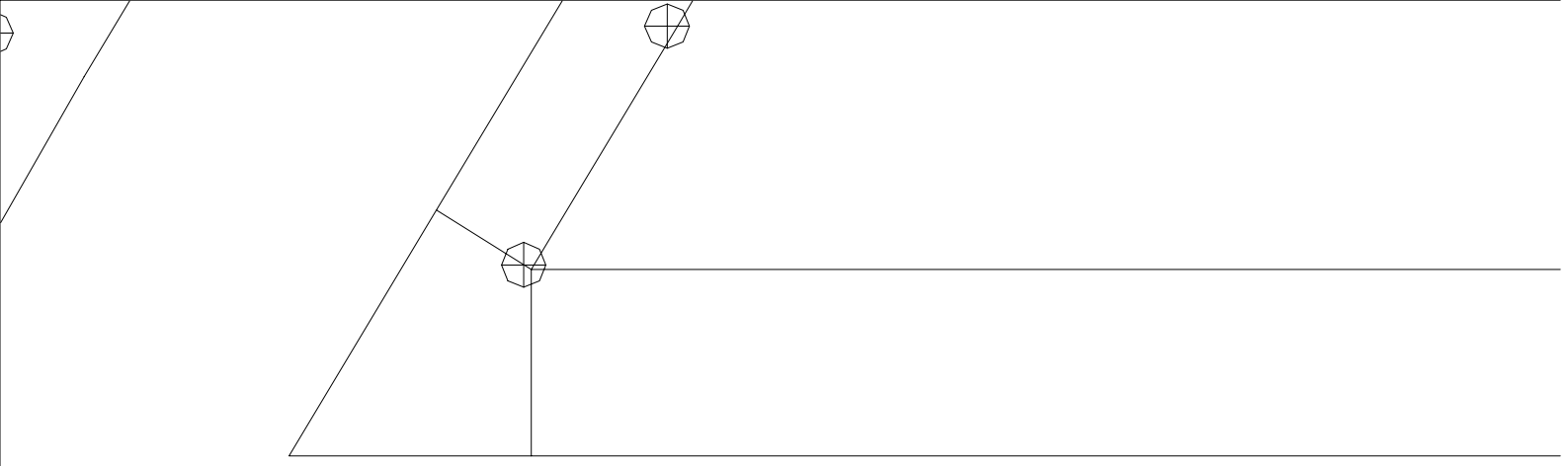

4-23

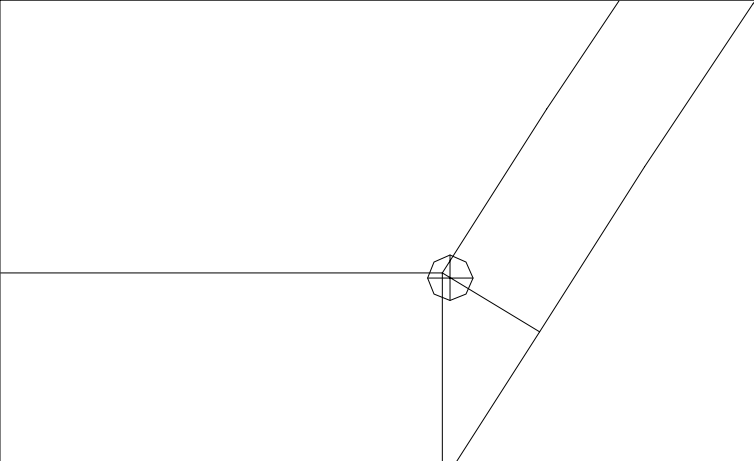

4-24

4-25



The image shows a vertical handwriting guide consisting of three parallel vertical lines. At the top and bottom of each line, there is a small octagonal symbol with a cross inside. In the center, a light gray rectangular box contains the equation $4 - 2$ written in red ink.

$$4 - 2$$

$$4 - 3$$

$$4 - 4$$

4-5

4-6

The diagram consists of four vertical lines. The leftmost and rightmost lines each have a circle at the top and bottom. The two middle lines have circles at the top. A light blue rectangular box is positioned in the center, overlapping the two middle lines. Inside the box, the equation $4 - 7$ is written in red.

$$4 - 7$$

$$4 - 8$$



4 - 9



5-10

5-11



5-12

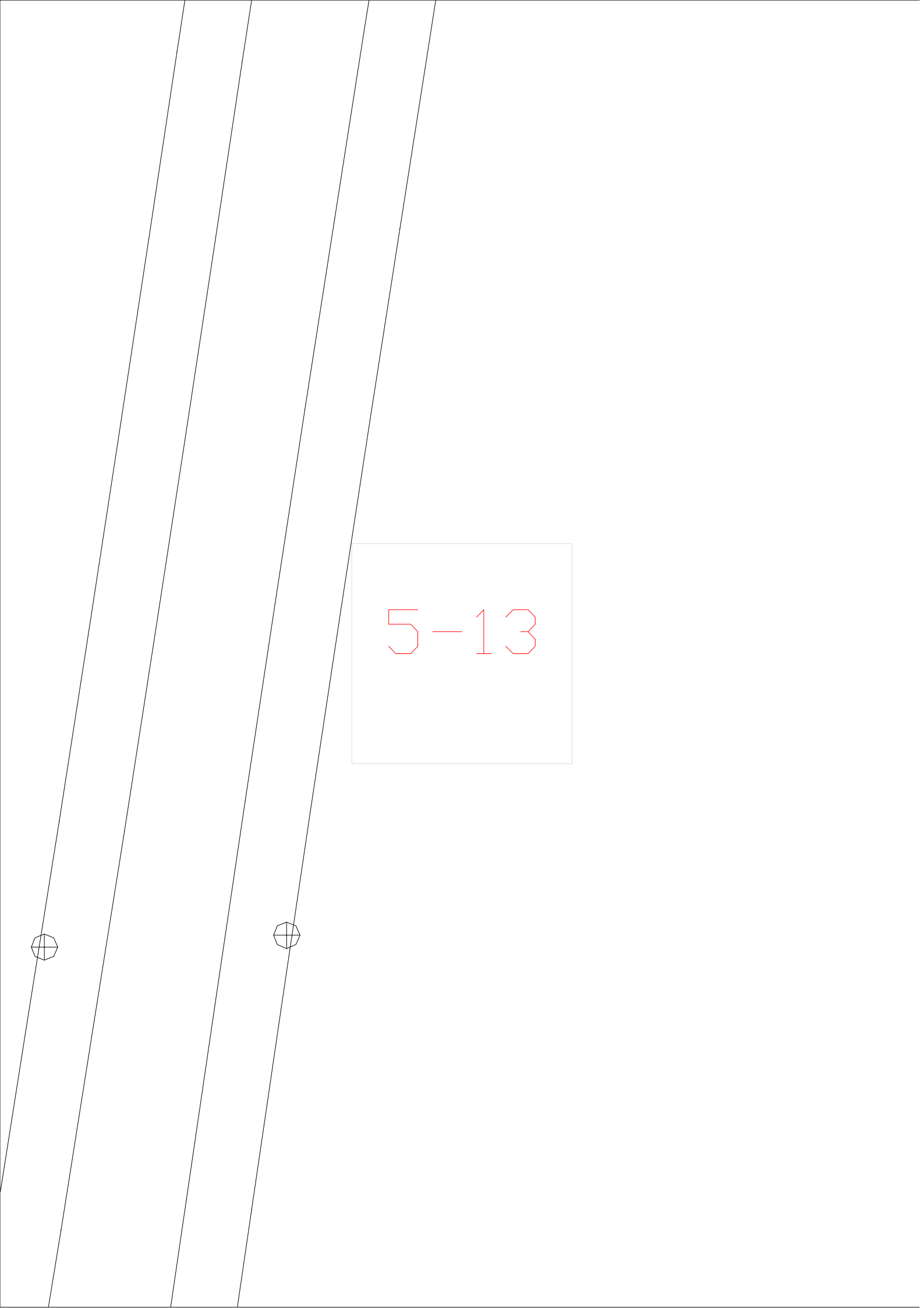

5-13

The image shows a technical drawing of a tapered shaft. The shaft is represented by two parallel lines that converge towards the top, indicating a taper. A central hole is shown as a circle with a cross inside, positioned at the bottom of the shaft. The drawing is oriented vertically. A rectangular box with a thin border is positioned to the right of the shaft, containing the text '5-13' in a red, monospace-style font.

5-14



5-15



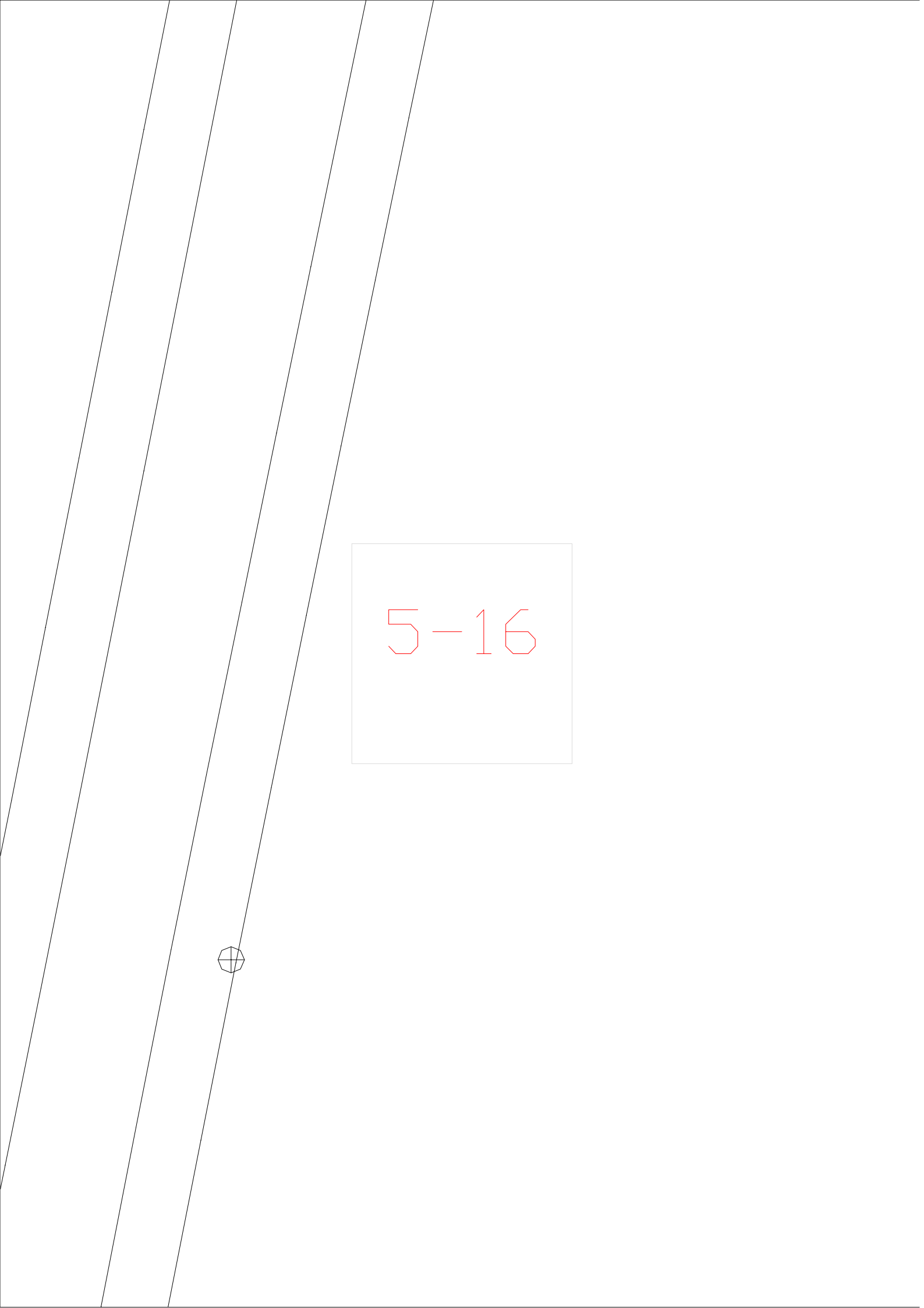

5-16

5-17



5-18



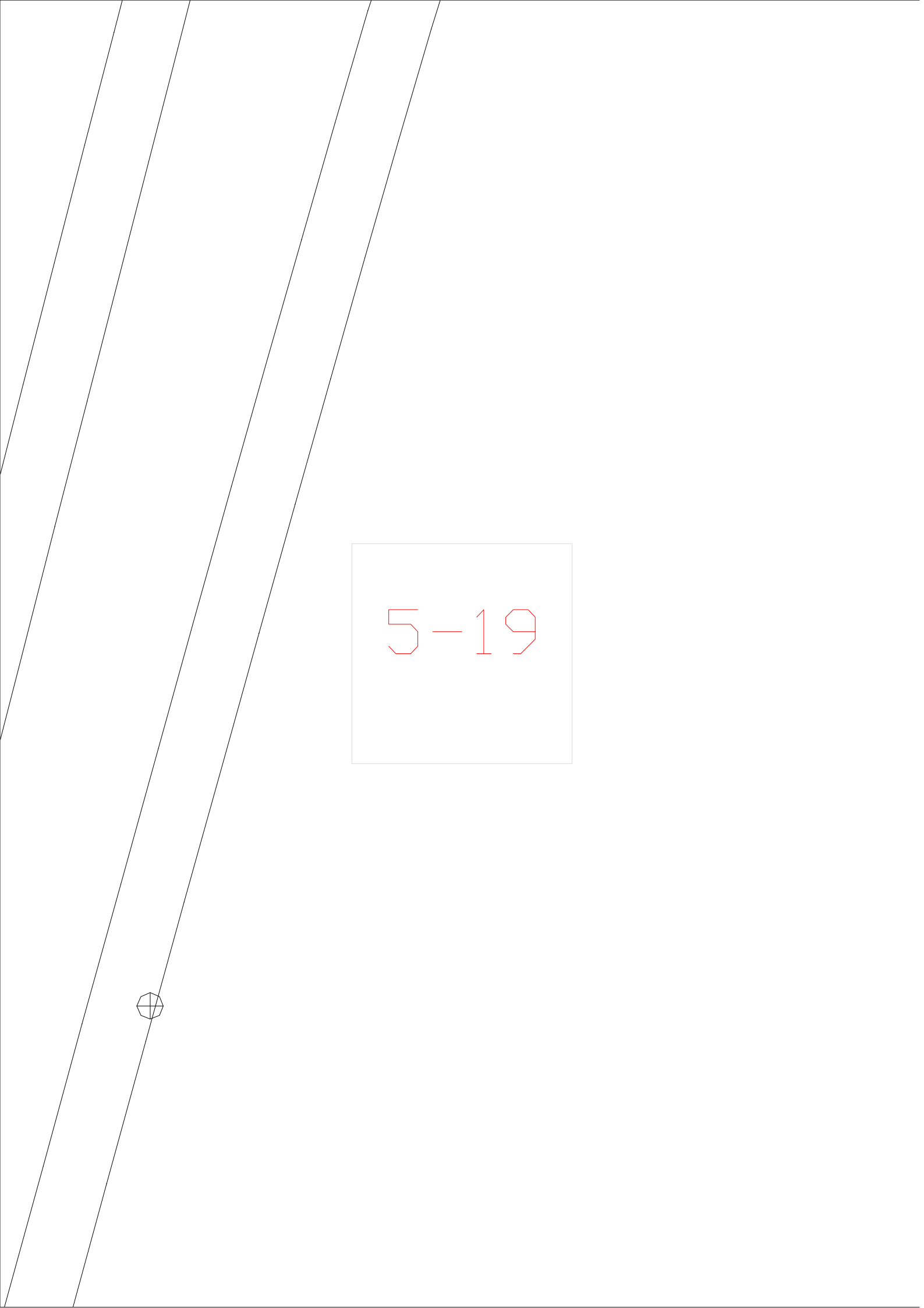

5-19

The image shows a technical drawing of a tapered shaft on the left side. The shaft is represented by two parallel lines that converge towards the top. A hexagonal hole is shown on the shaft, with a small circle at its center. To the right of the shaft, there is a rectangular callout box containing the text '5-19' in red.

5-1



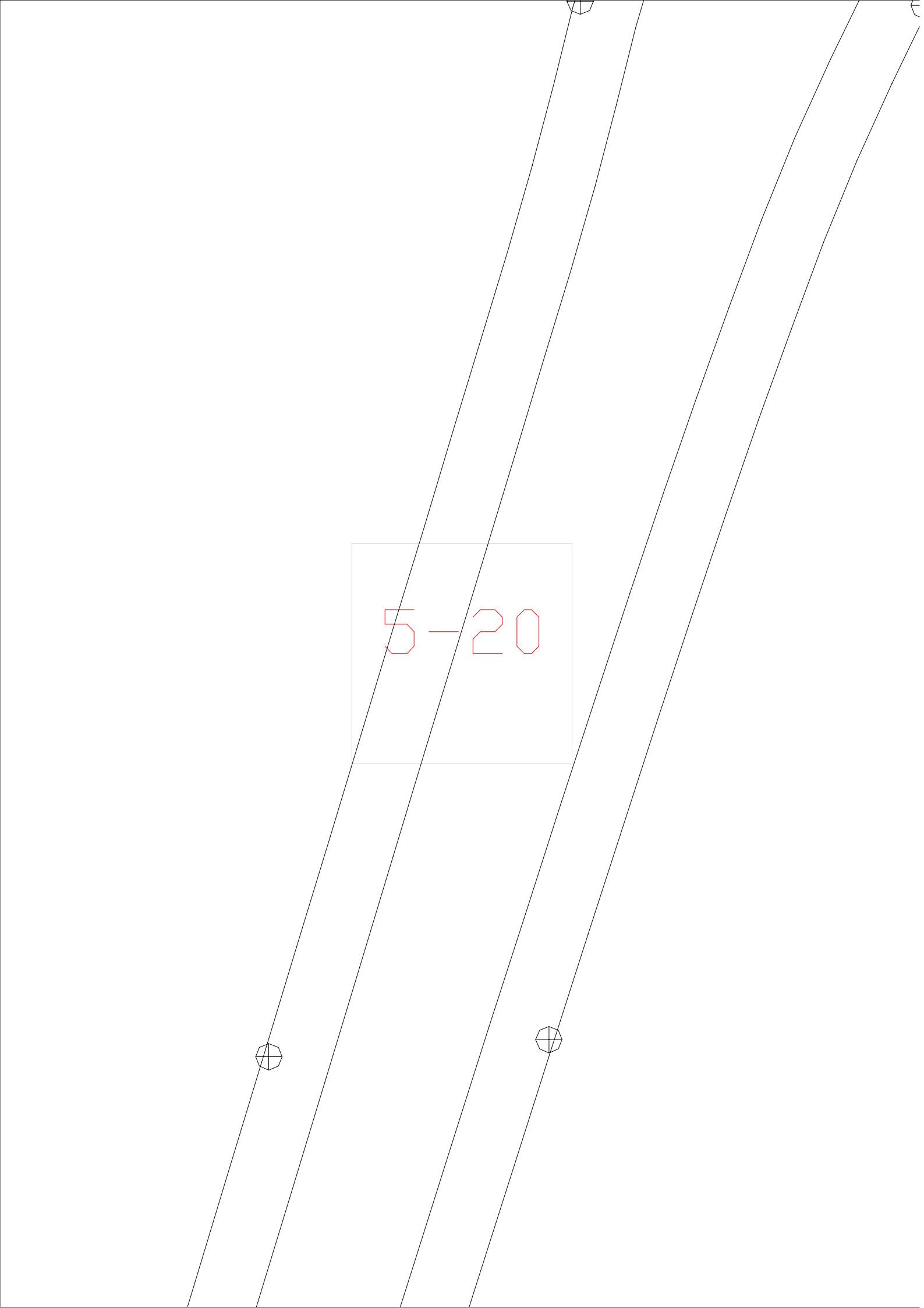

5-20

The image shows a technical drawing of a tapered shaft. The shaft is represented by four parallel lines that converge towards the top, indicating its taper. A central rectangular box contains the text '5-20' in red. There are four circular features, each with a crosshair, positioned at the top and bottom of the shaft's length. The top features are partially cut off by the top edge of the drawing.

5-21



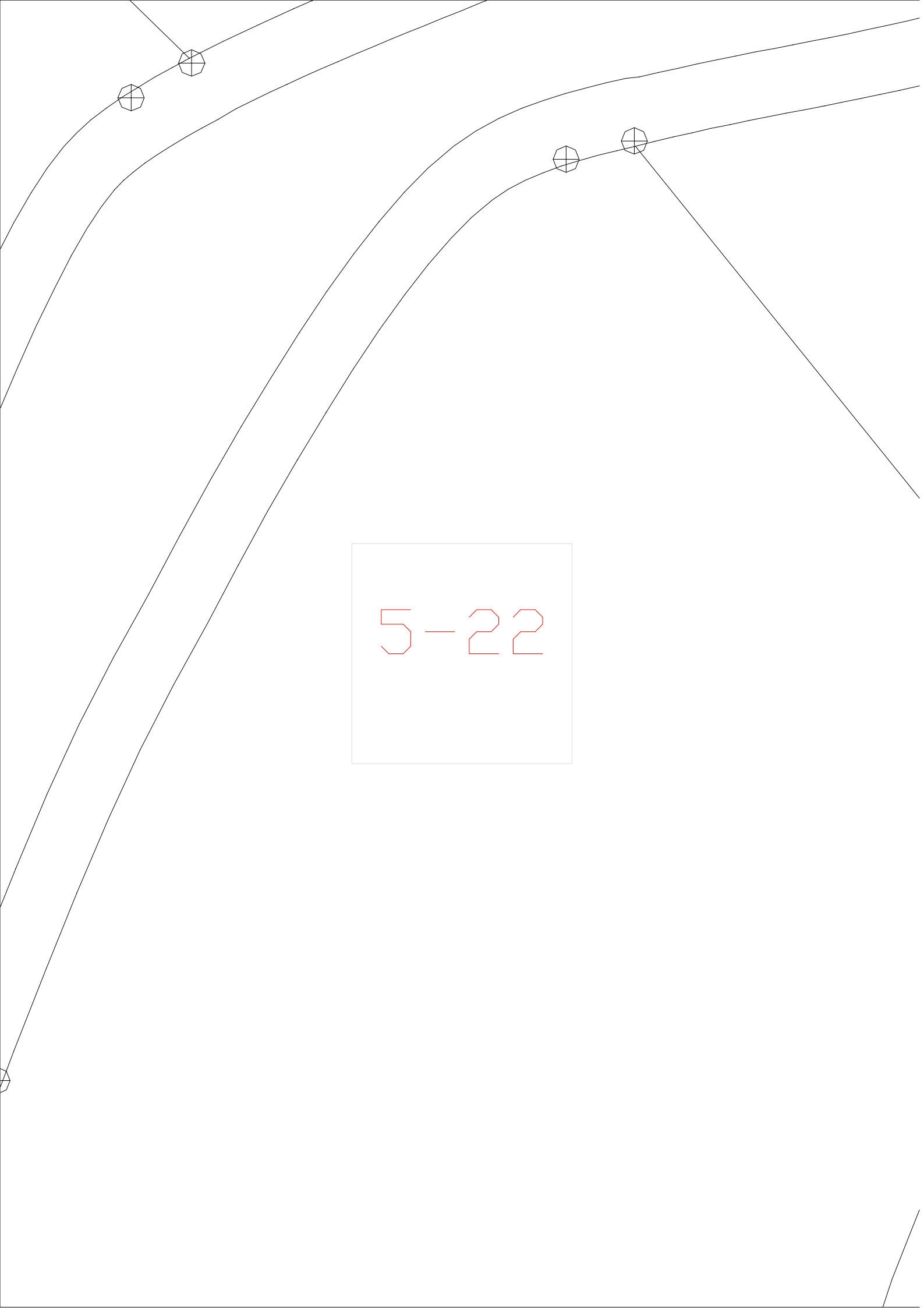

5-22

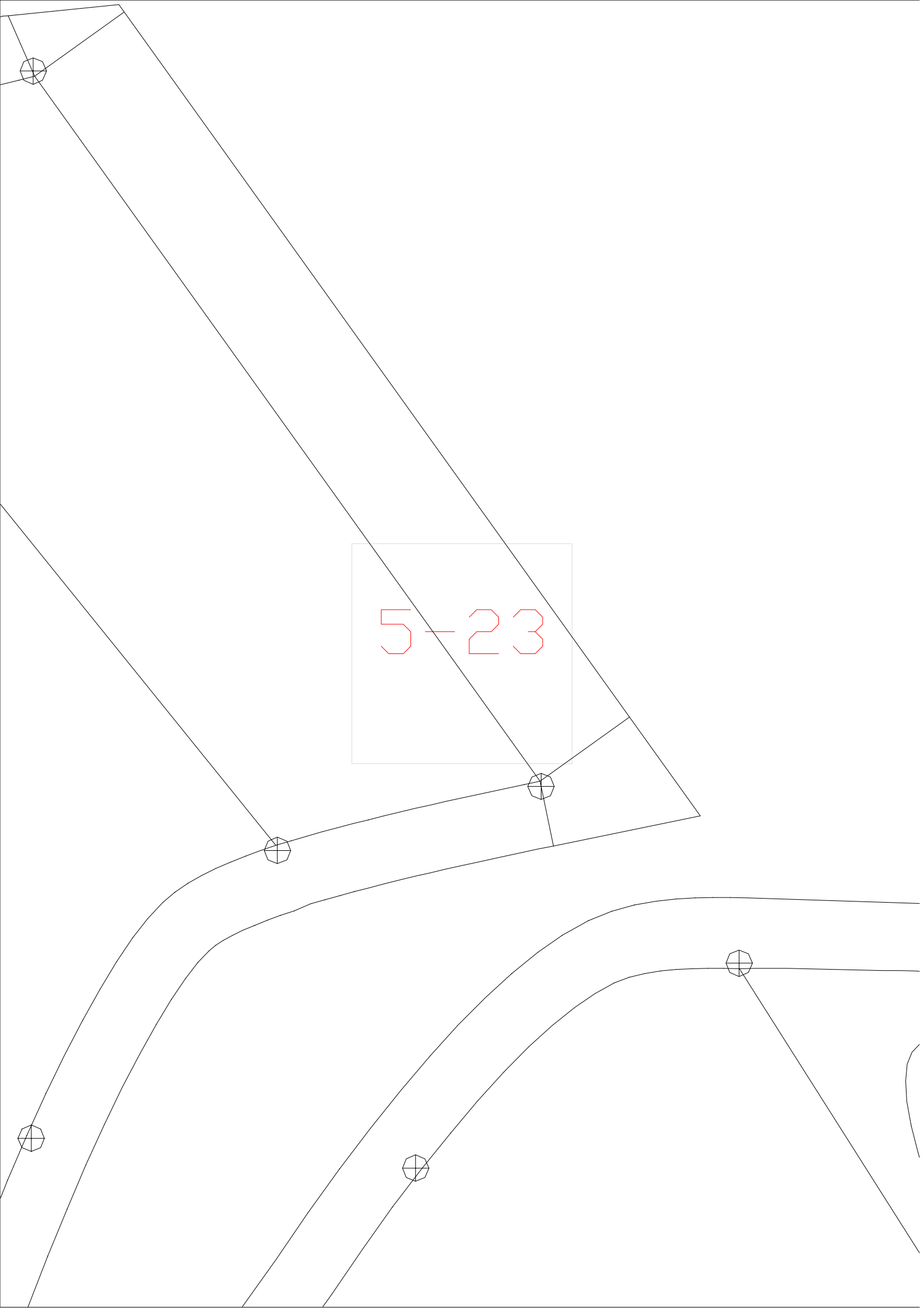

5-23

5-24

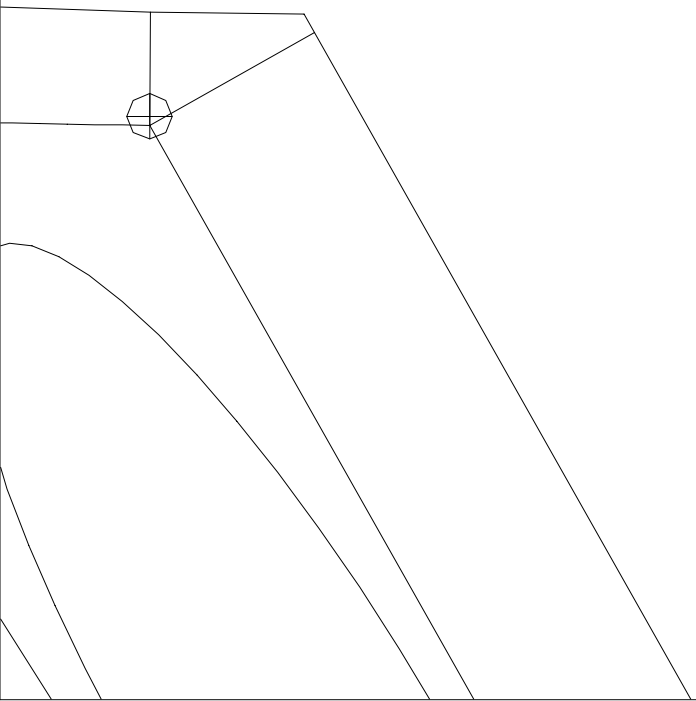

5-25

5-2



5-3

5-4



5-5



5-6

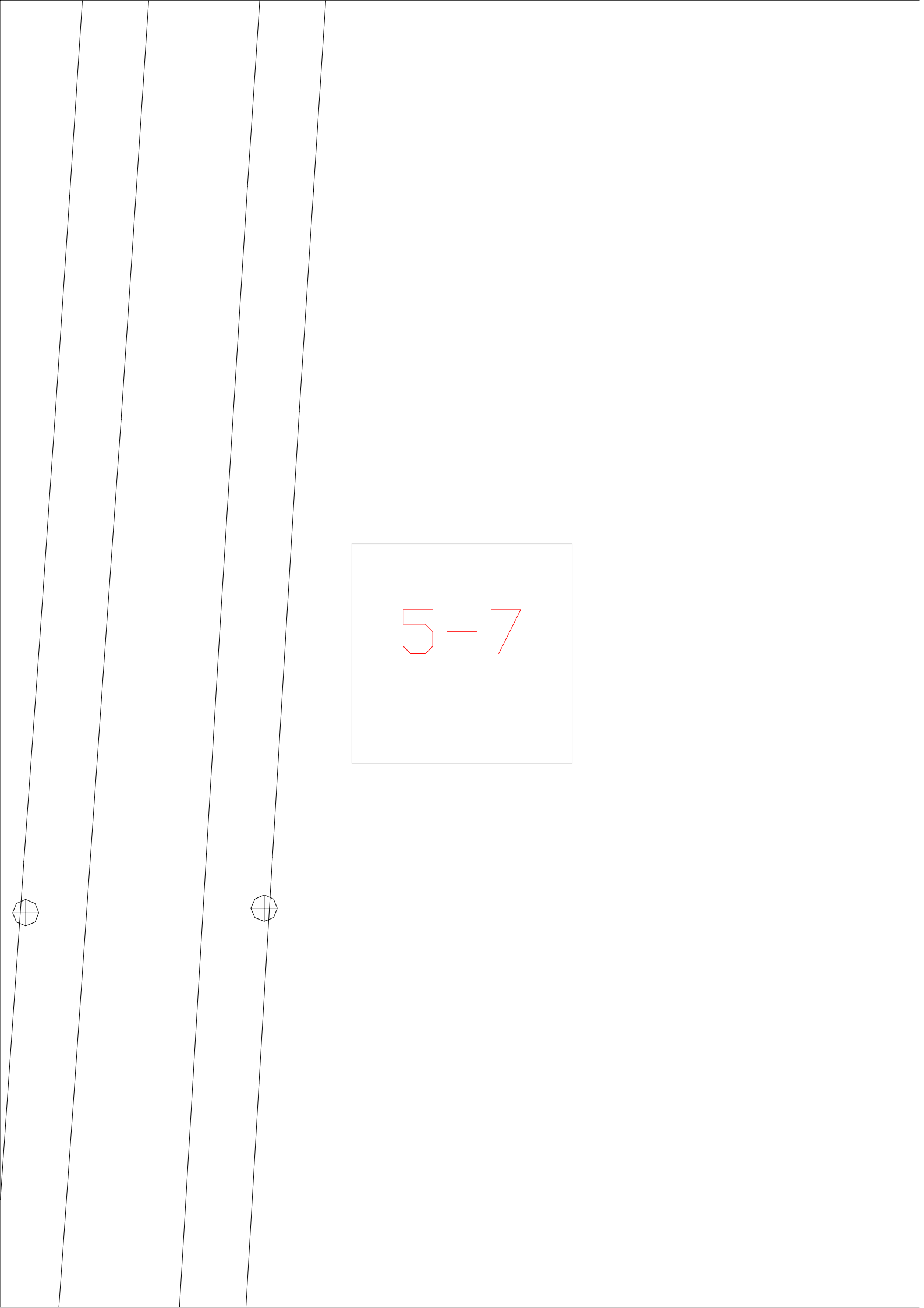

5-7

5-8



5-9



6-10

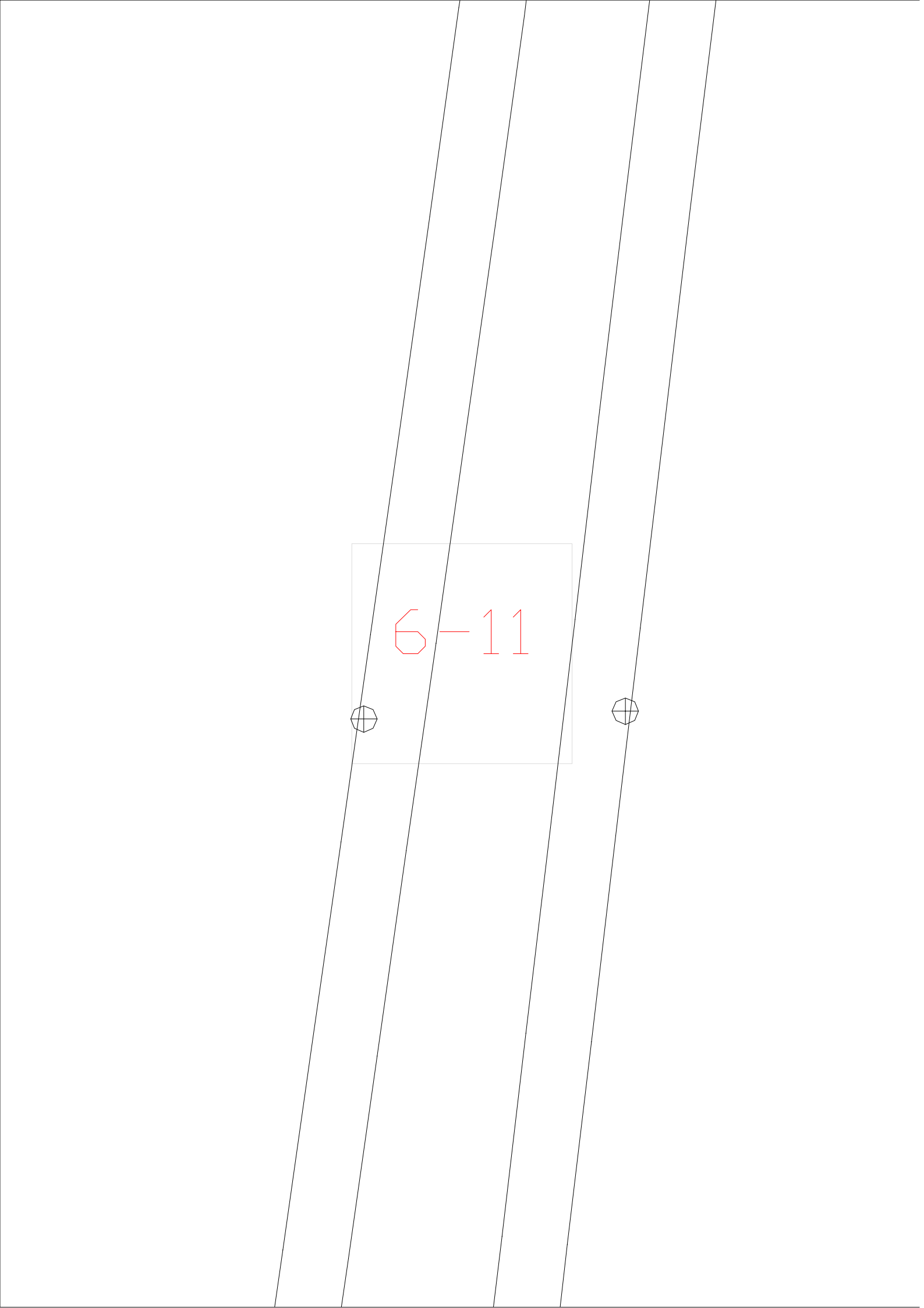

6-11



6-12



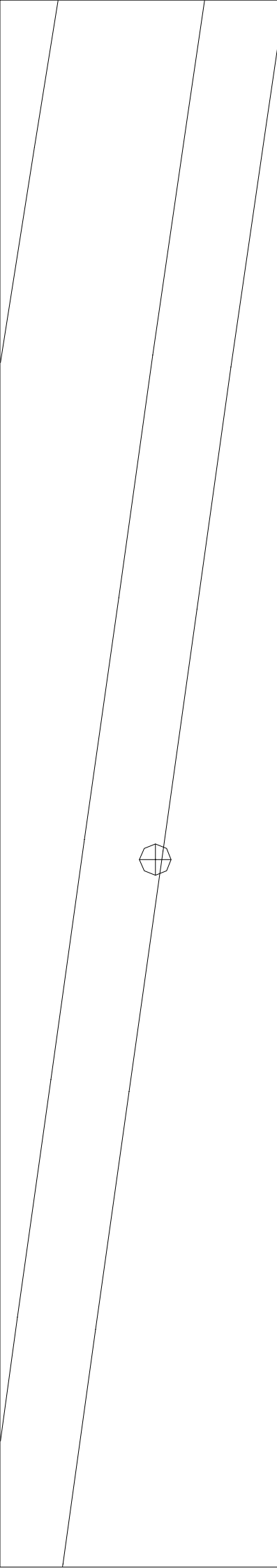

6-13

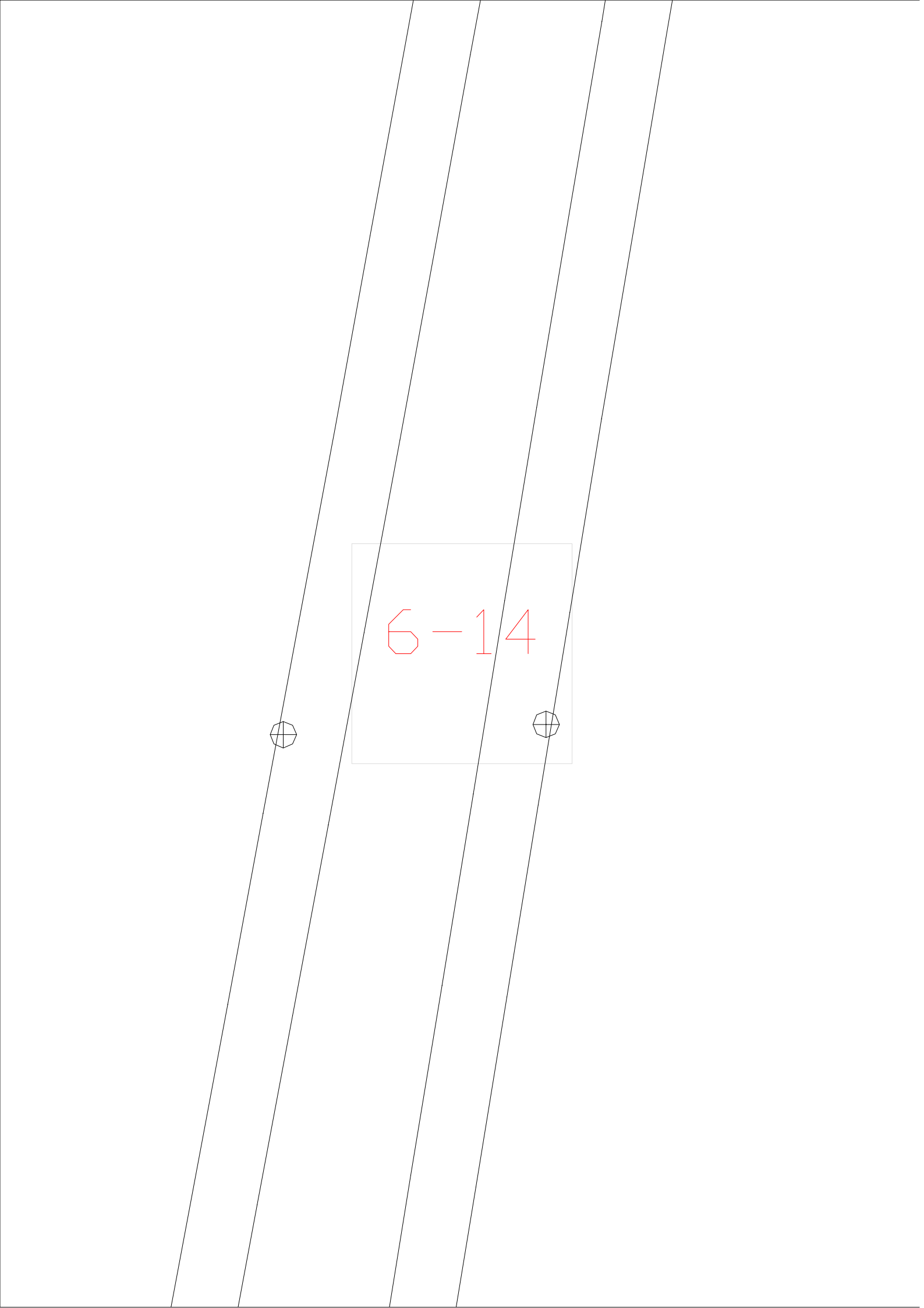

6-14

6-15



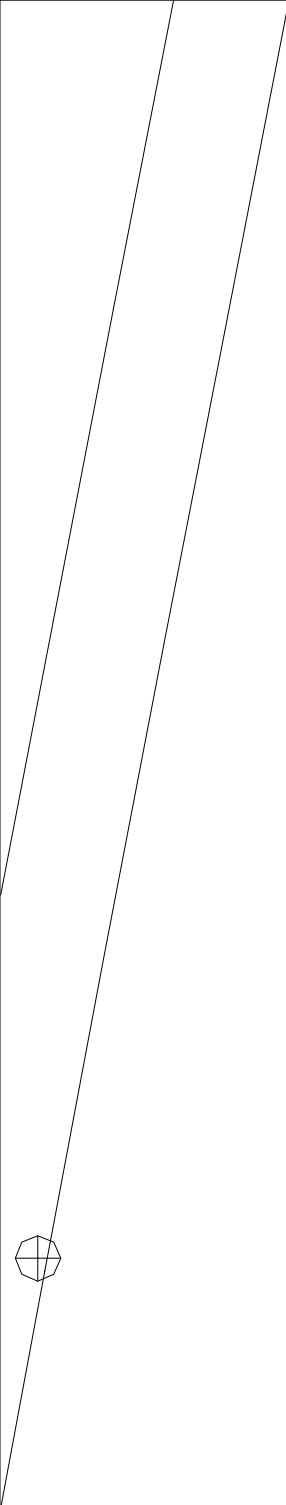

6-16

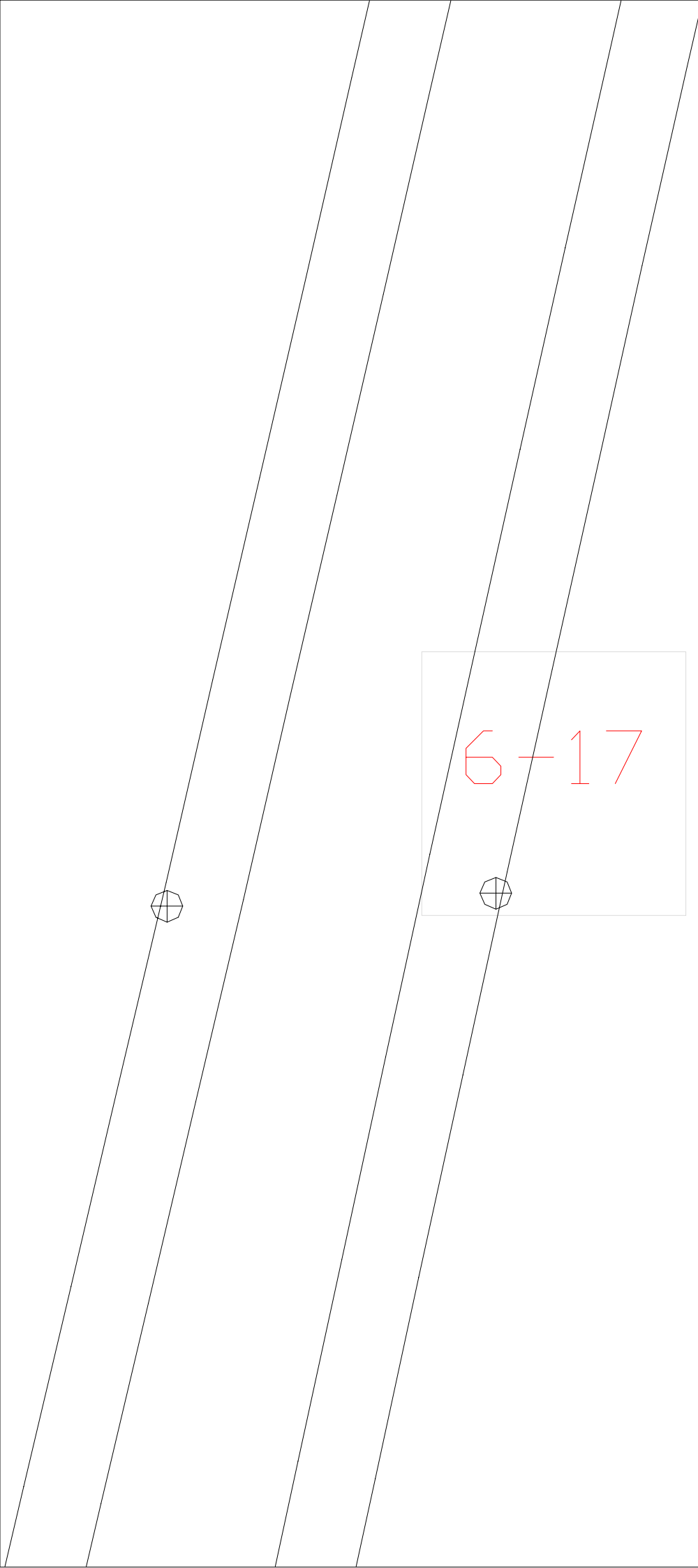

6-17

6-18



6-19





6-1

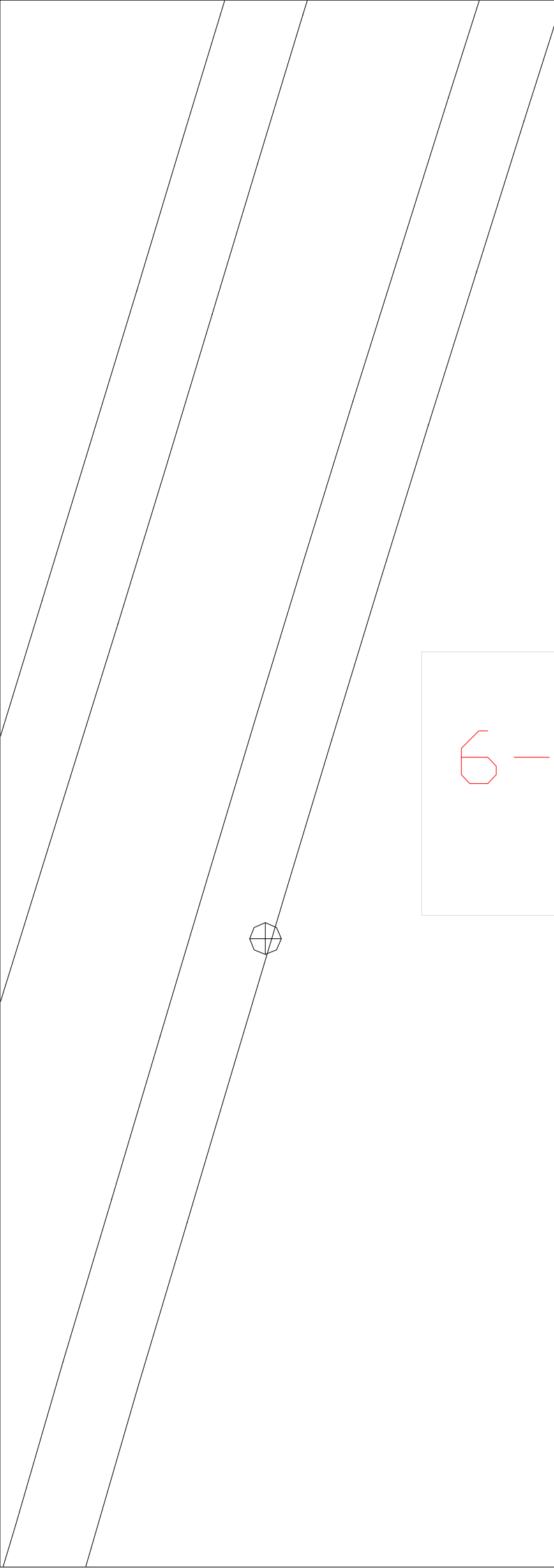

6-20

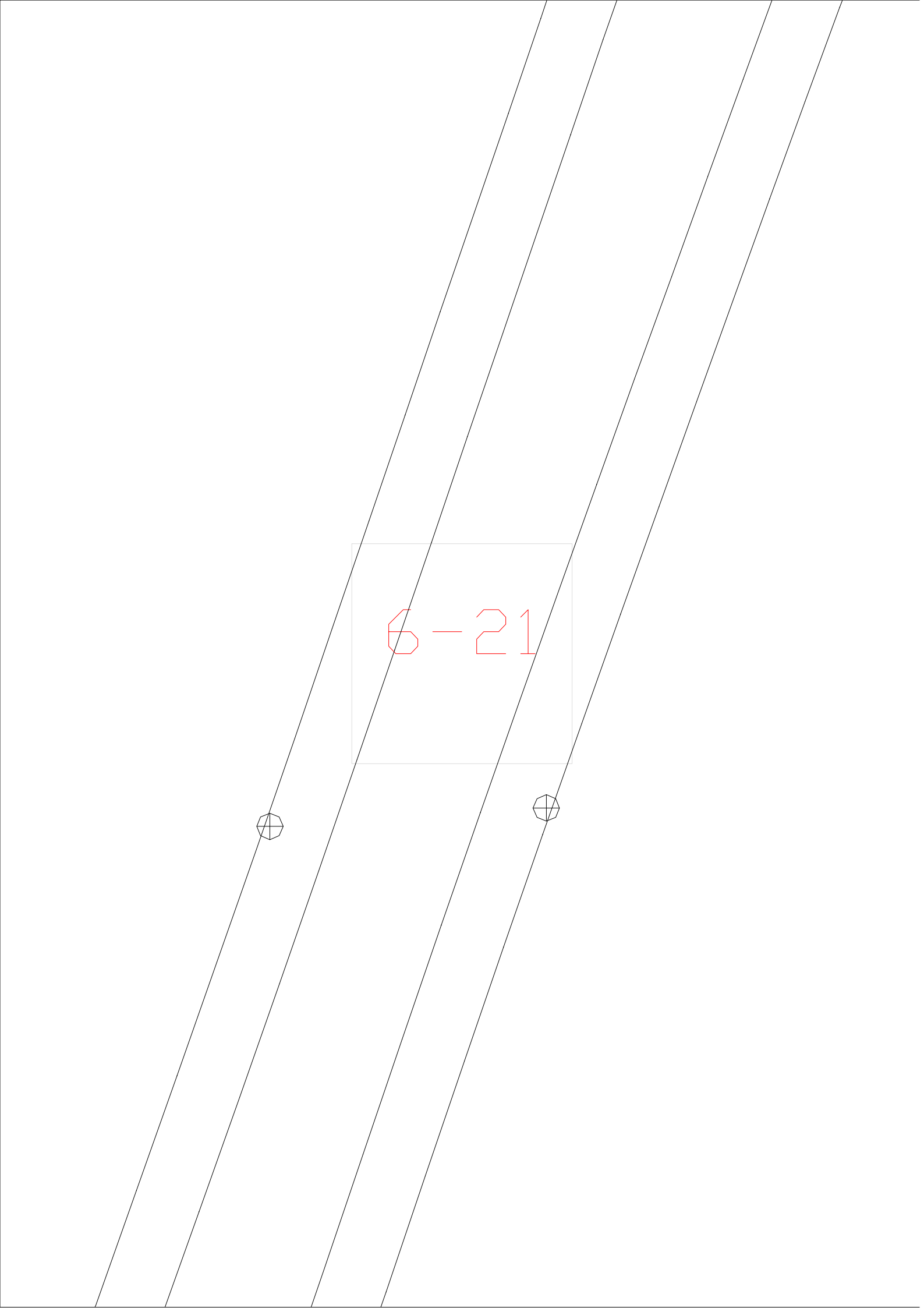

6-21

6-22



6-23



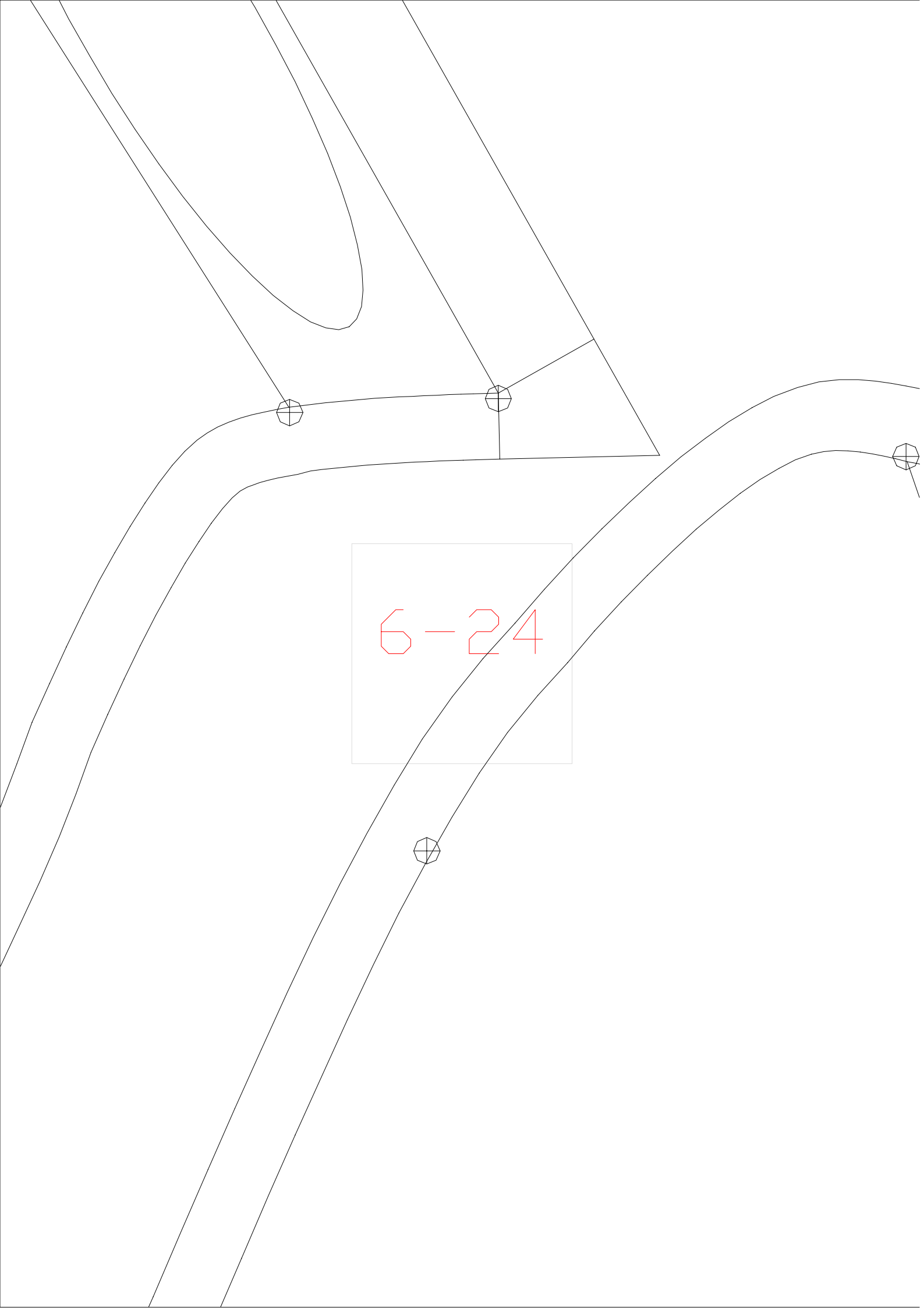

6-24

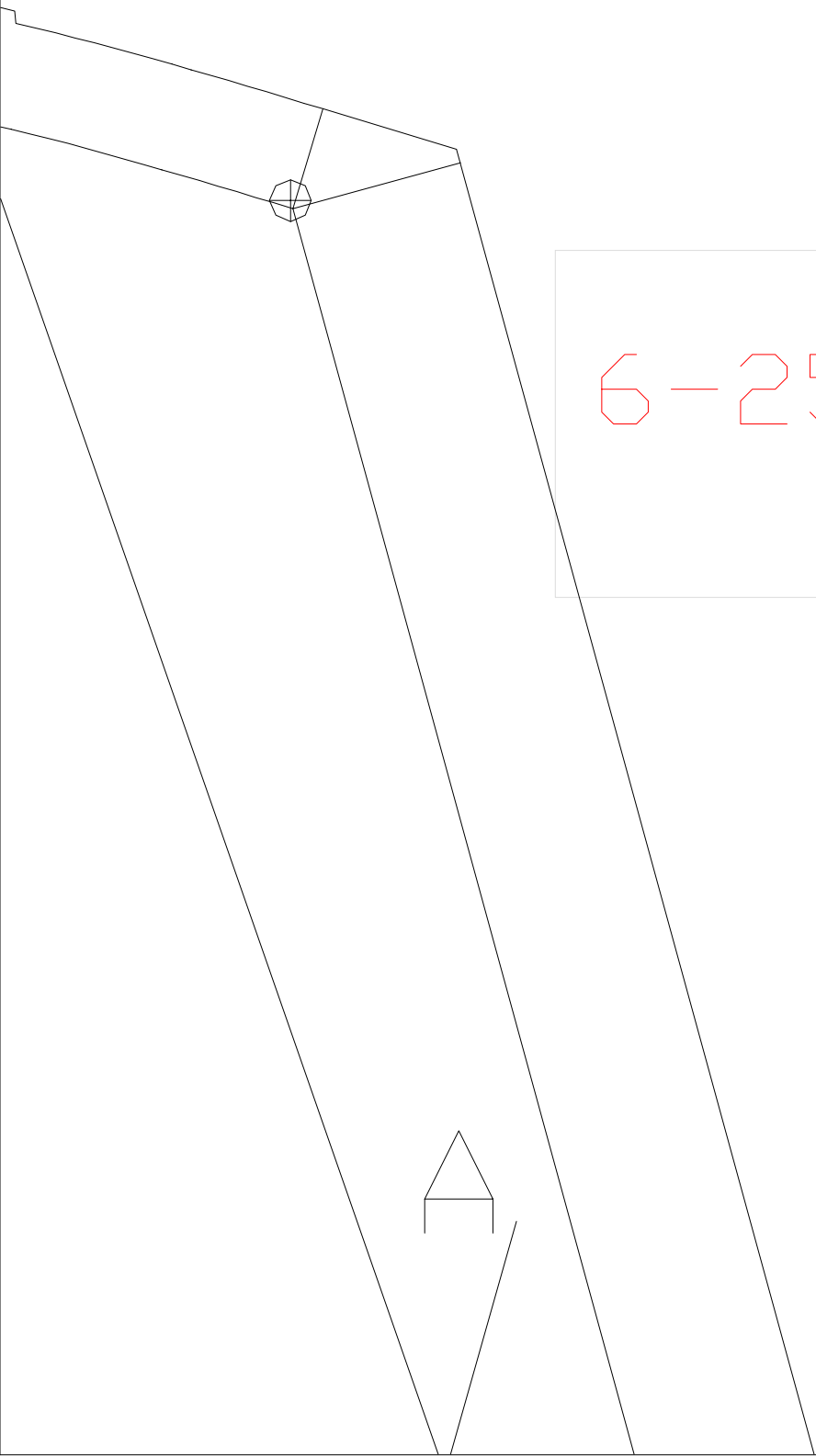

6-25

6-2



6-3





6-4

6-5



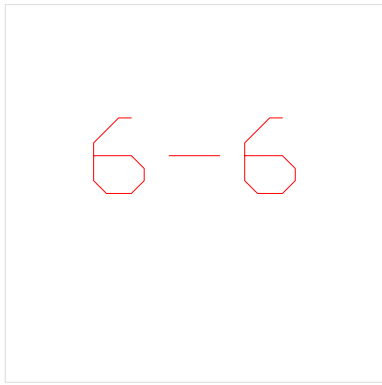

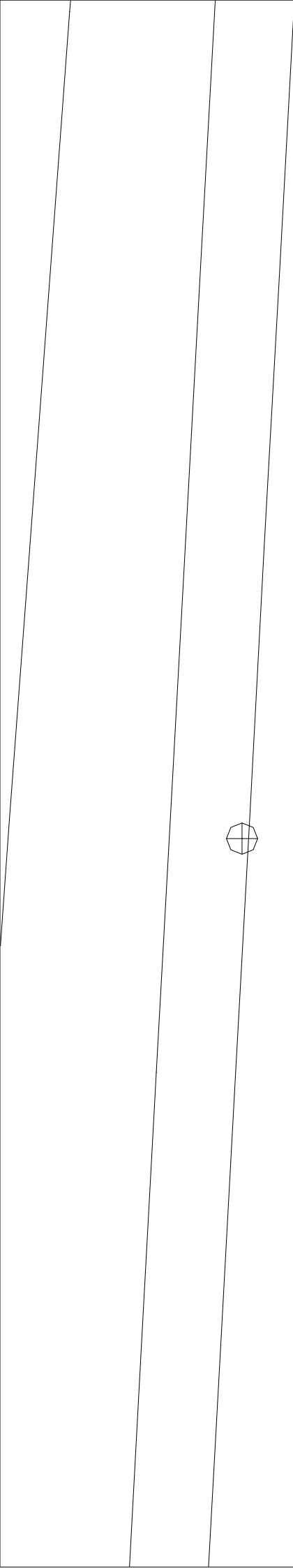

6-7

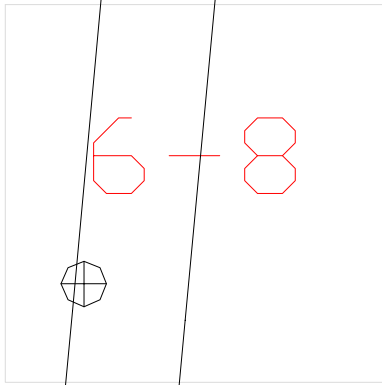

6-9





7-10



7-11

7-12



7-13



7-14



7-15

The image features a white background with four parallel, slanted lines running from the bottom-left towards the top-right. A light gray rectangular box is centered in the middle of the page, containing the text "7-15" in a red, monospace-style font. Two small, black-outlined geometric symbols, resembling a sphere with a cross, are positioned on the second and fourth lines from the left, one above and one below the central box.

7-16





7-17

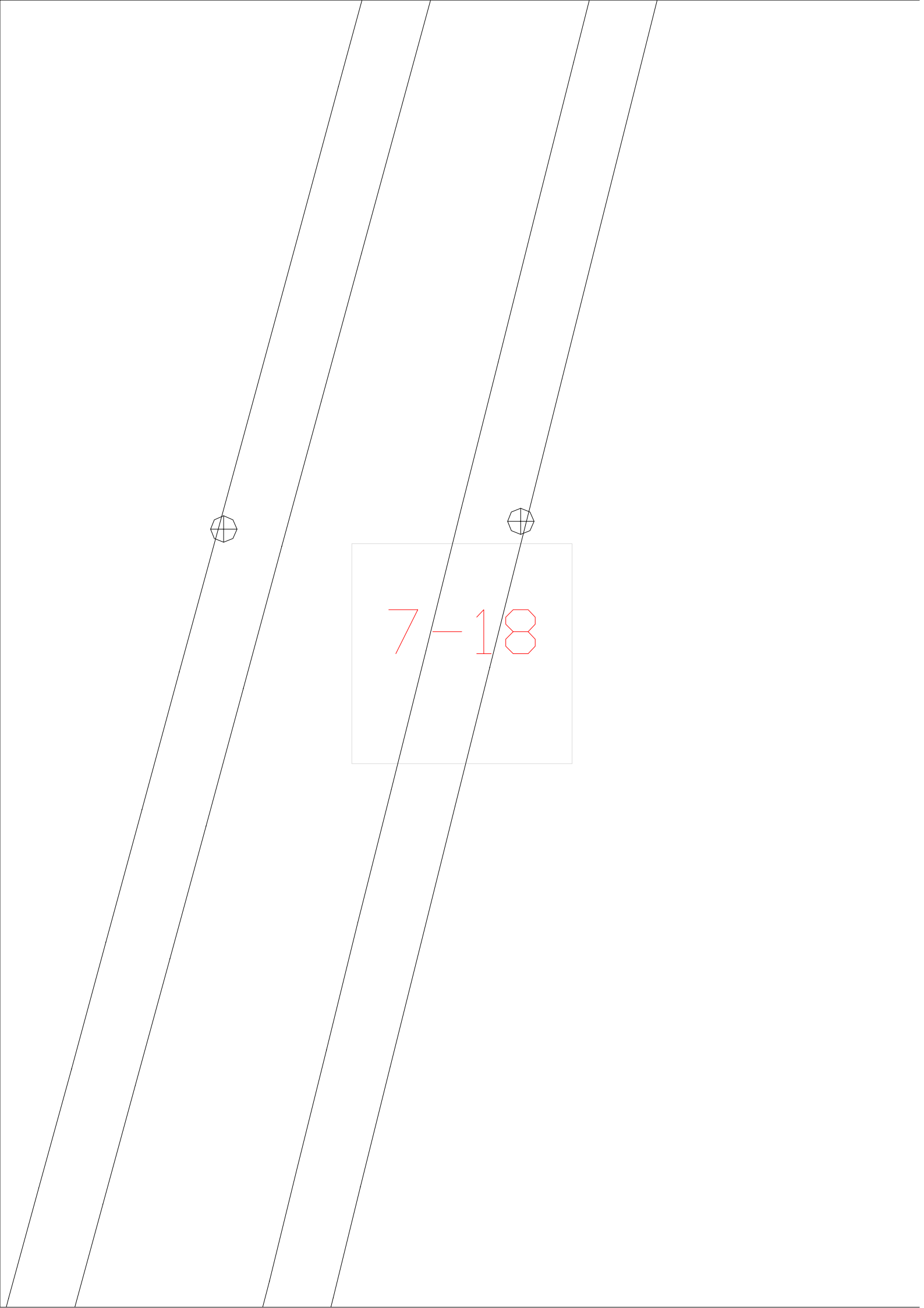

7-18

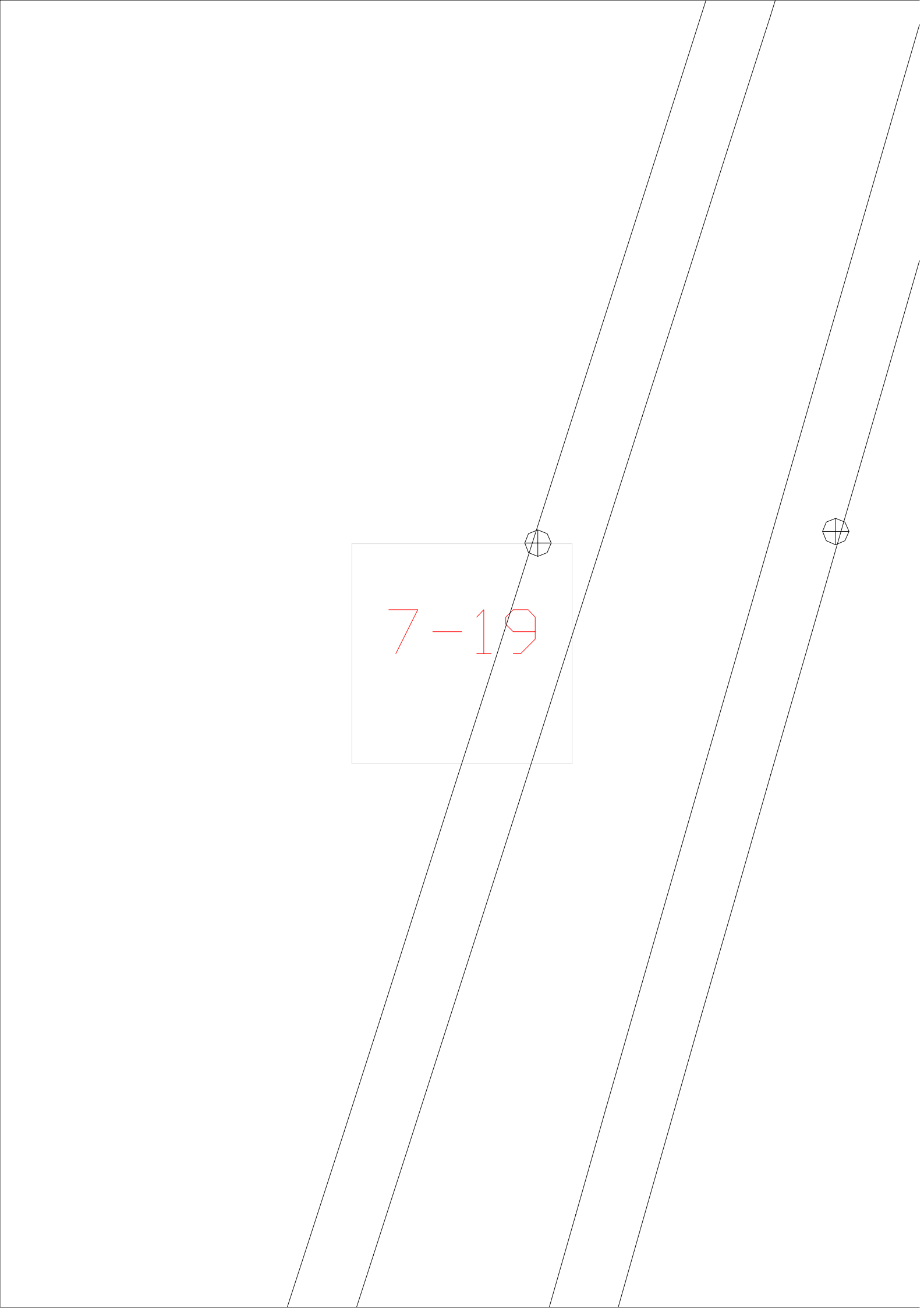

7-19

The image shows a diagram with four parallel lines slanted from bottom-left to top-right. A light gray rectangular box highlights the text '7-19' in red. Two small circular symbols, each containing a cross, are placed on the second and fourth lines from the left.



$$7 - 1$$

7-20





7-21



7-22

7-23

F O L D

7-24



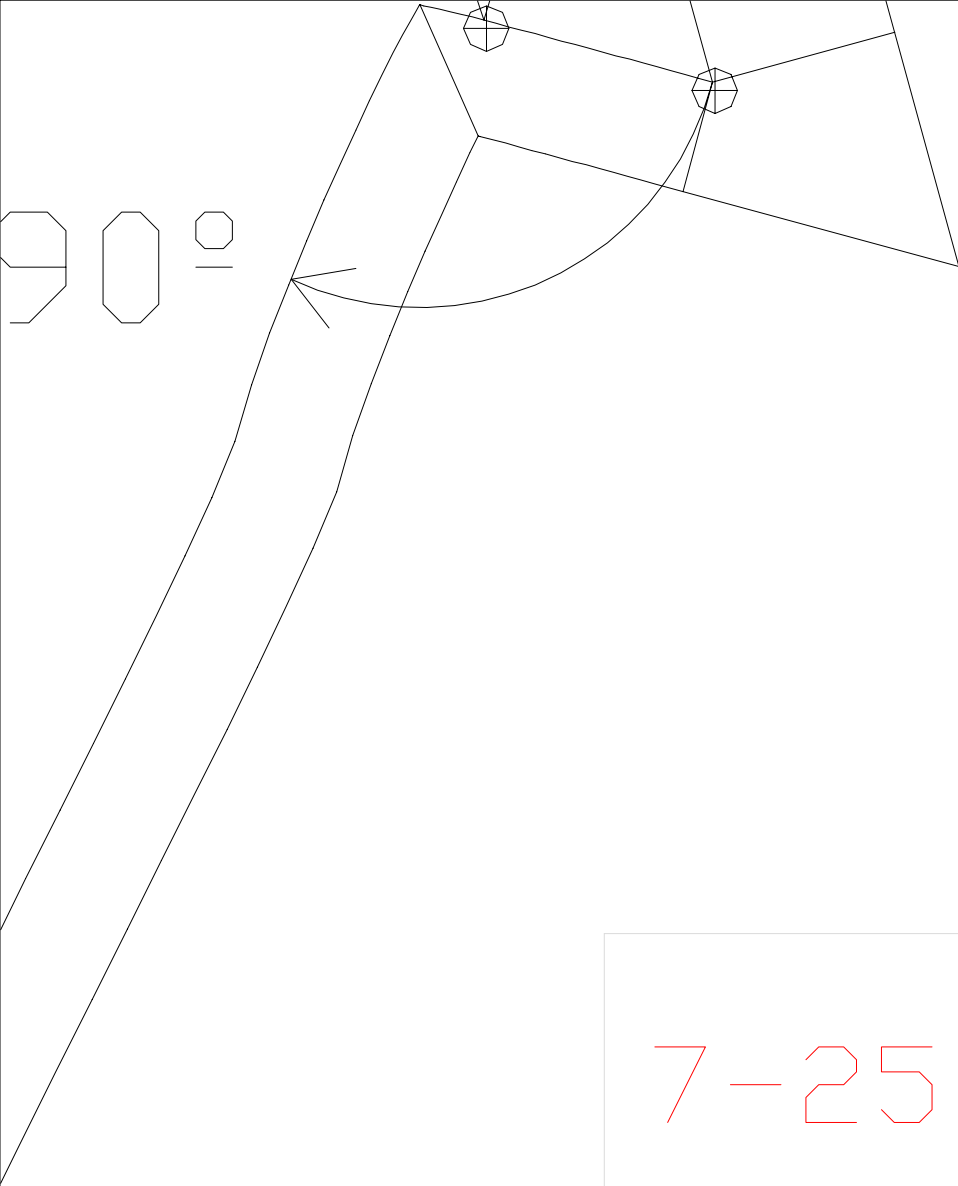

7-25



$$7-2$$

$$7 - 3$$





$$7 - 4$$



7-5

7-6





7-7



7-8

7-9



◦ ◦ ◦ ◦
◦

8-10

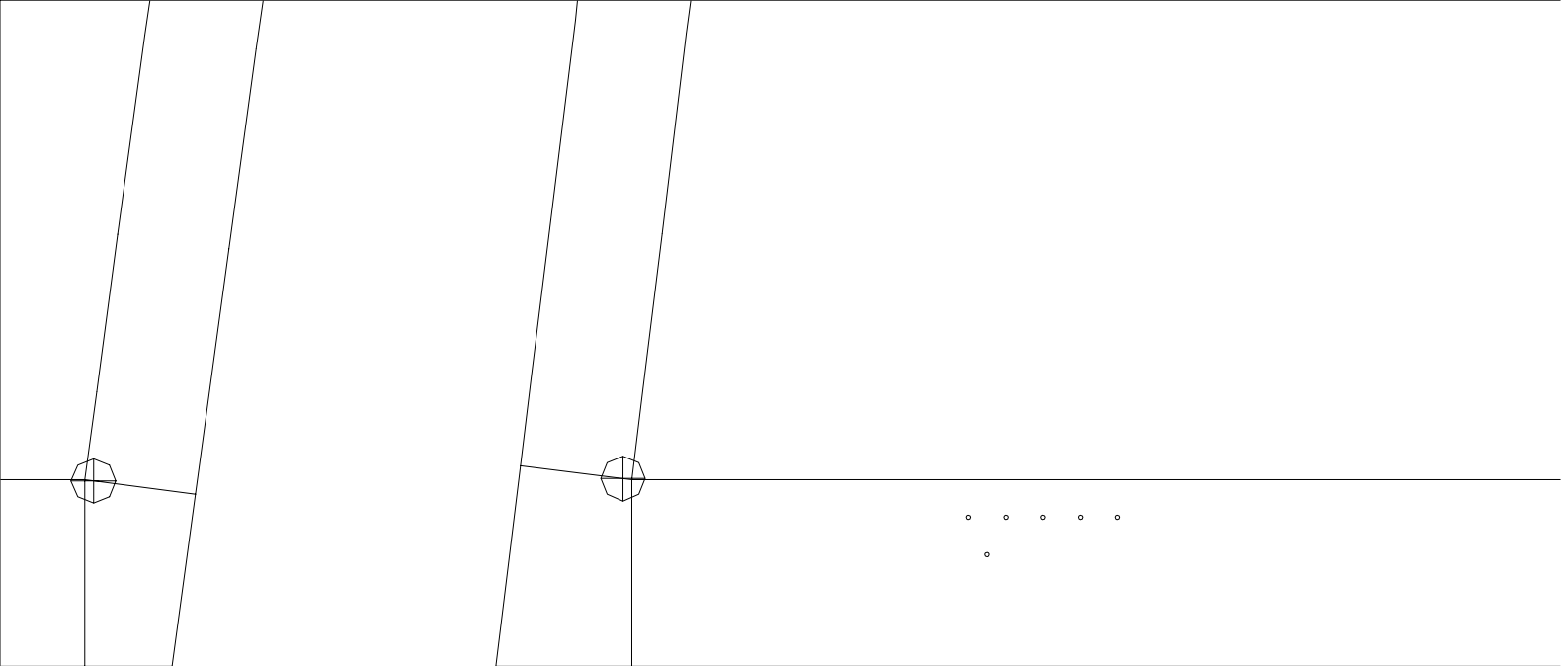

8-11

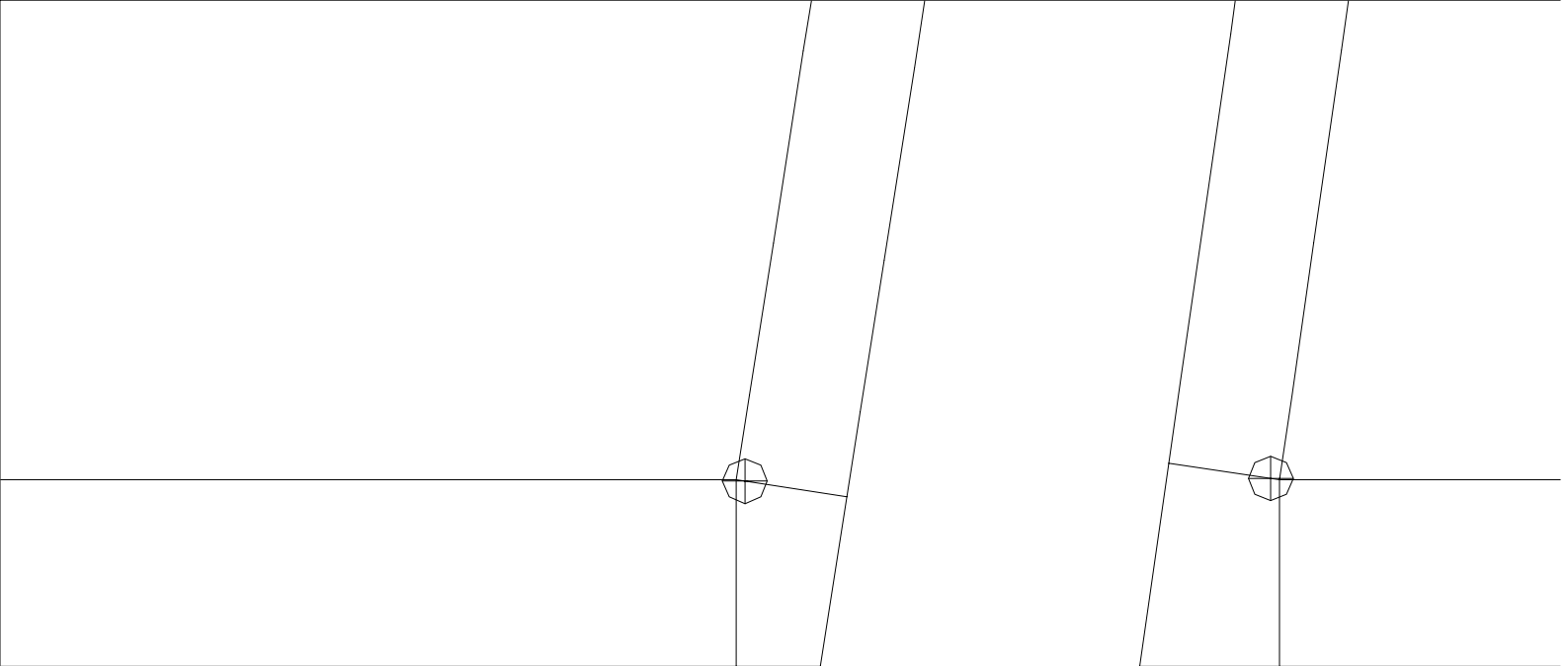

8-12



o o o o o o
o

8-13



8-14

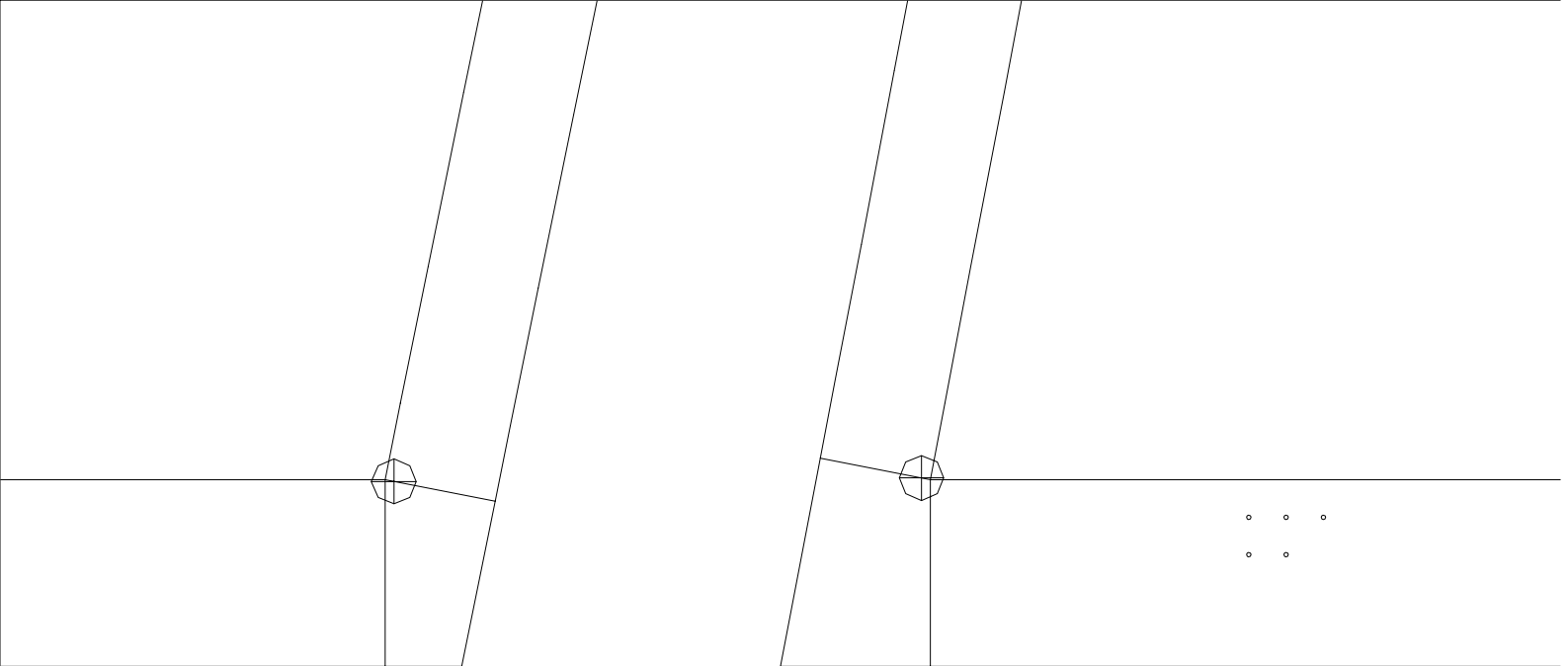

8-15

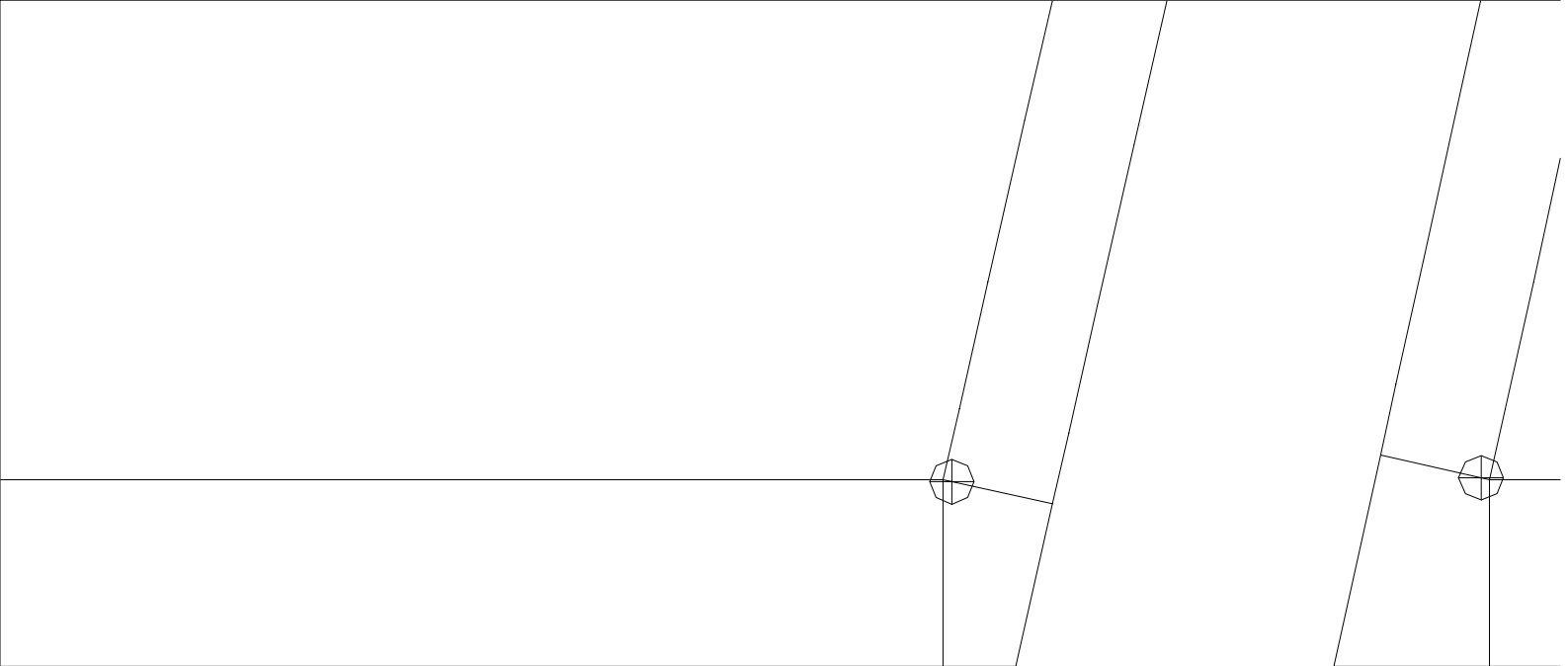

8-16

• • • •
• •



8-17

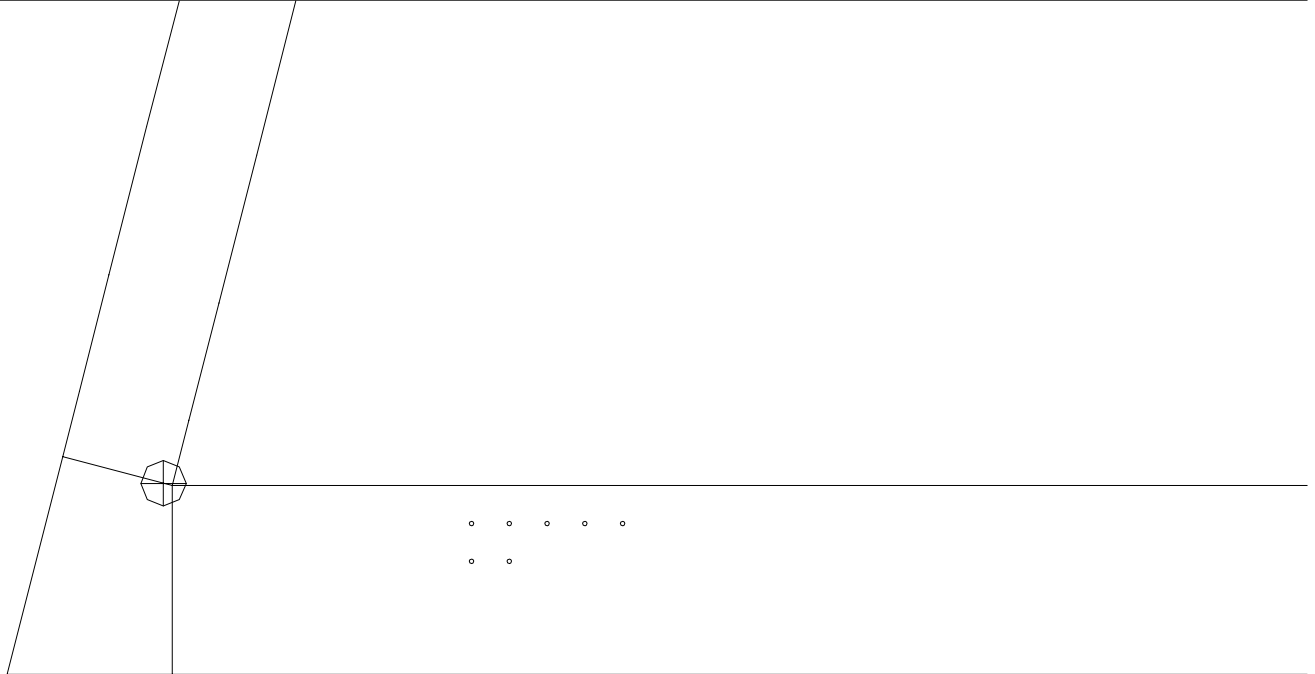

8-18

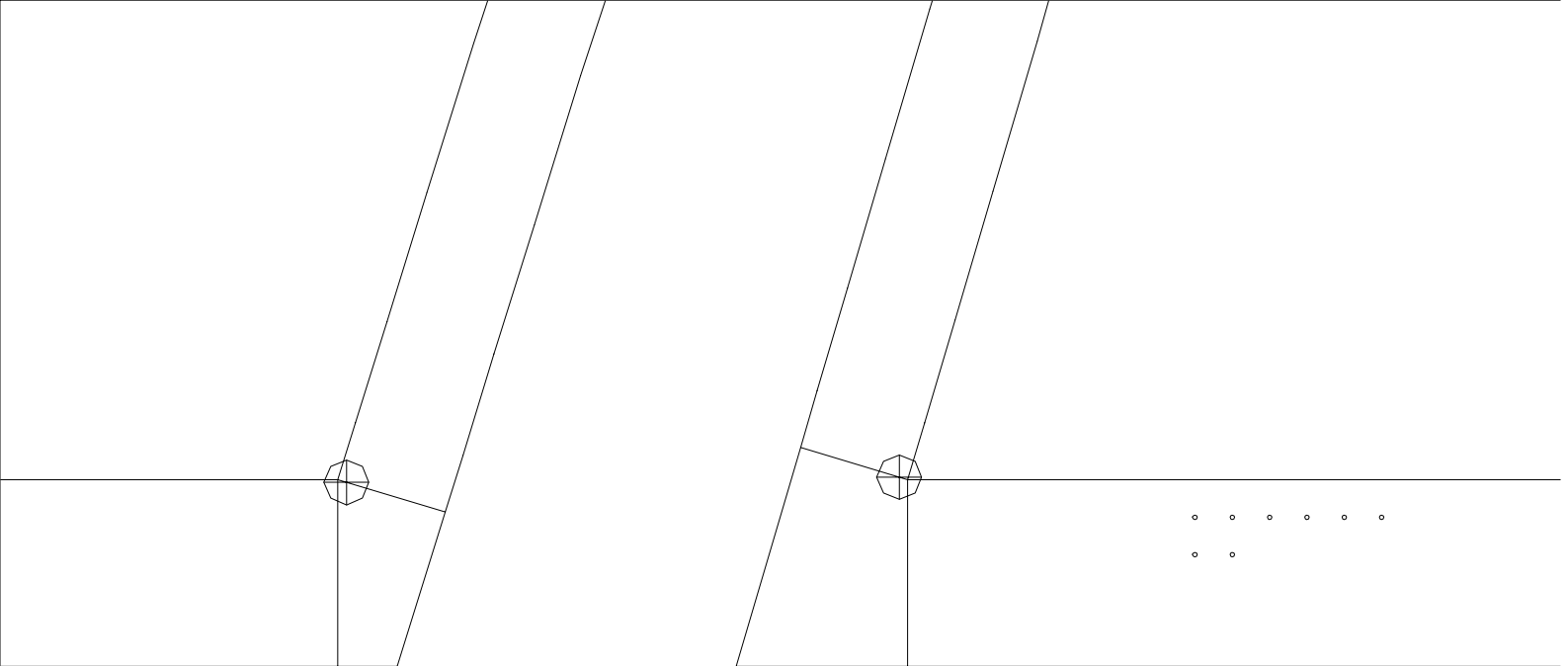

8-19



8-1

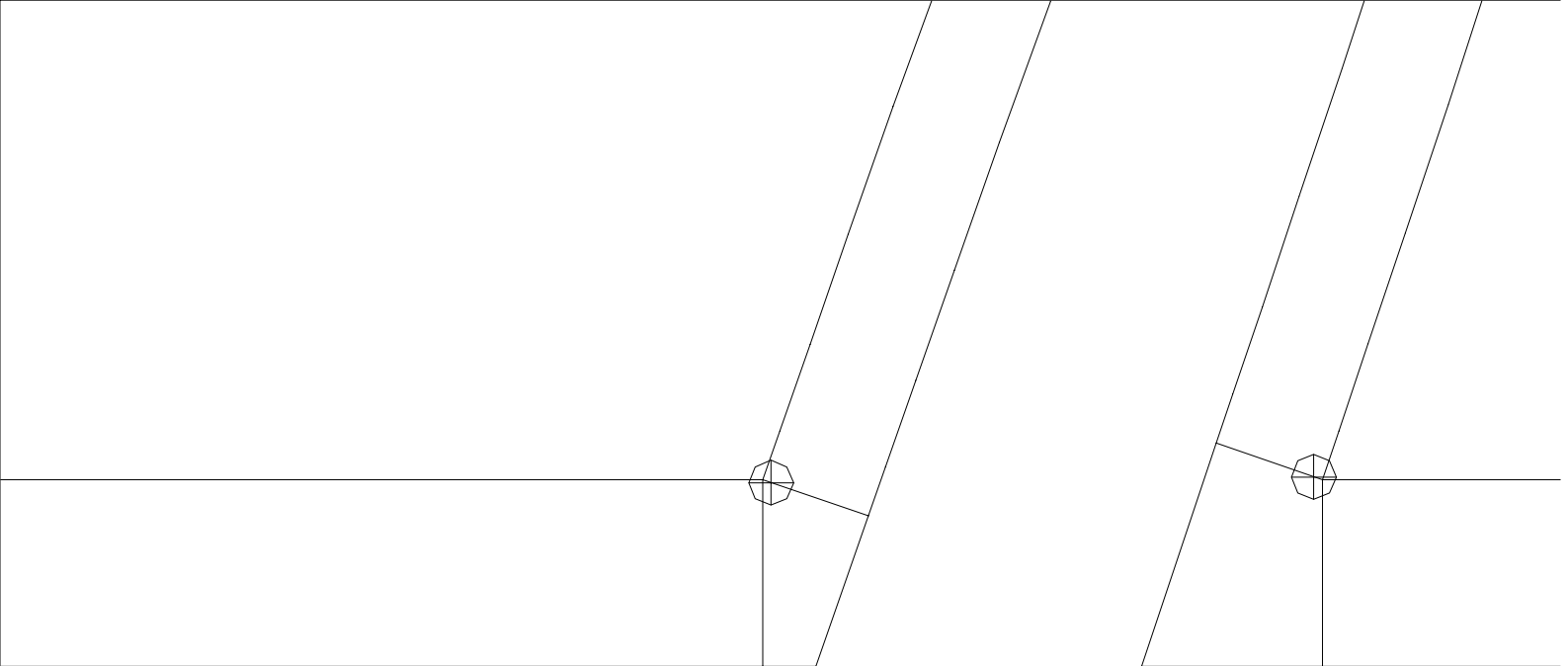

8-20

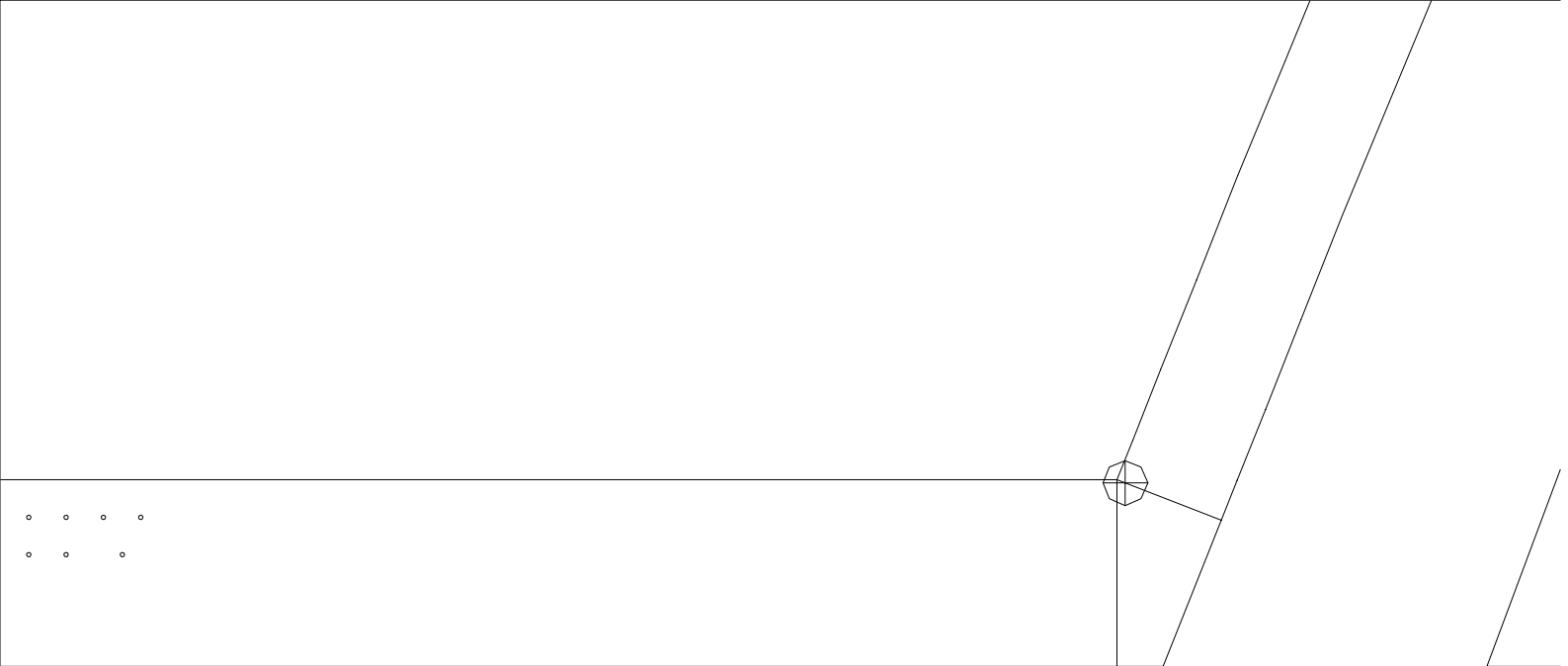

• • • •
• • •

8-21

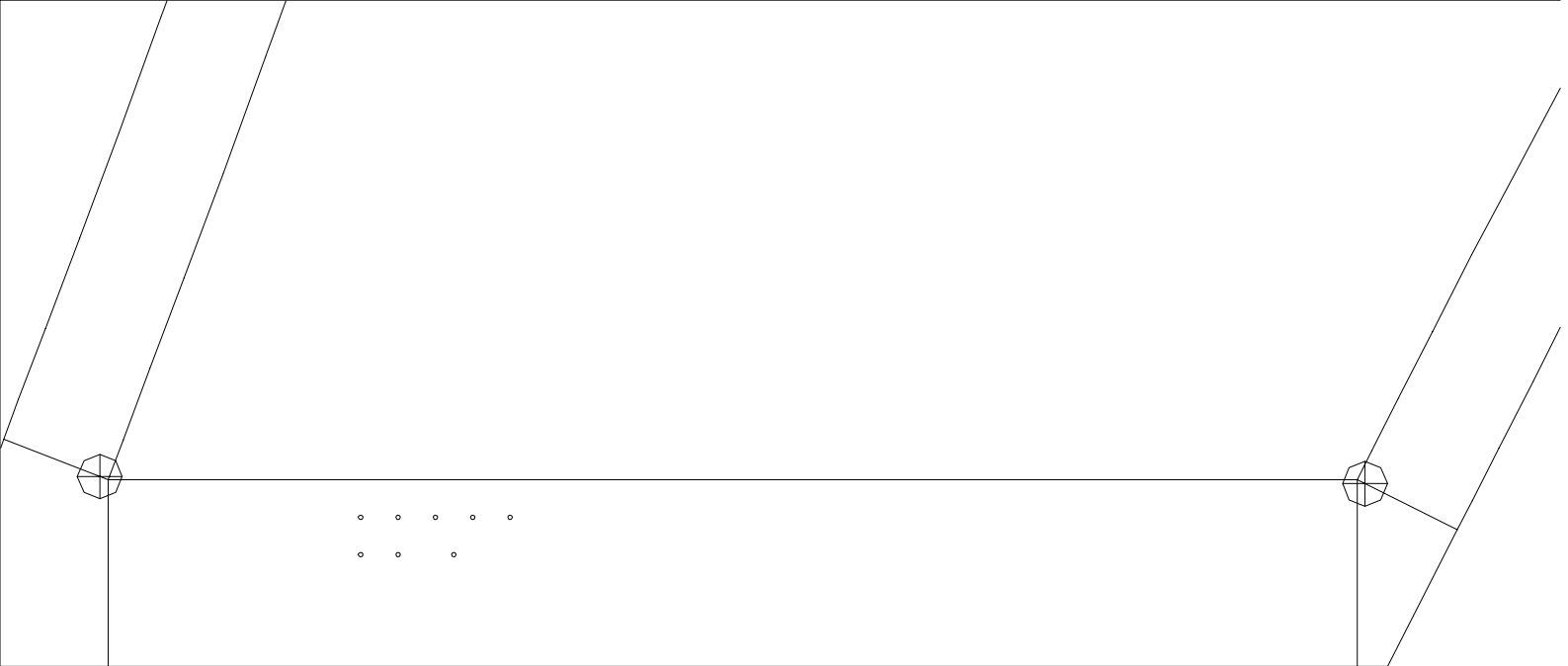

8-22

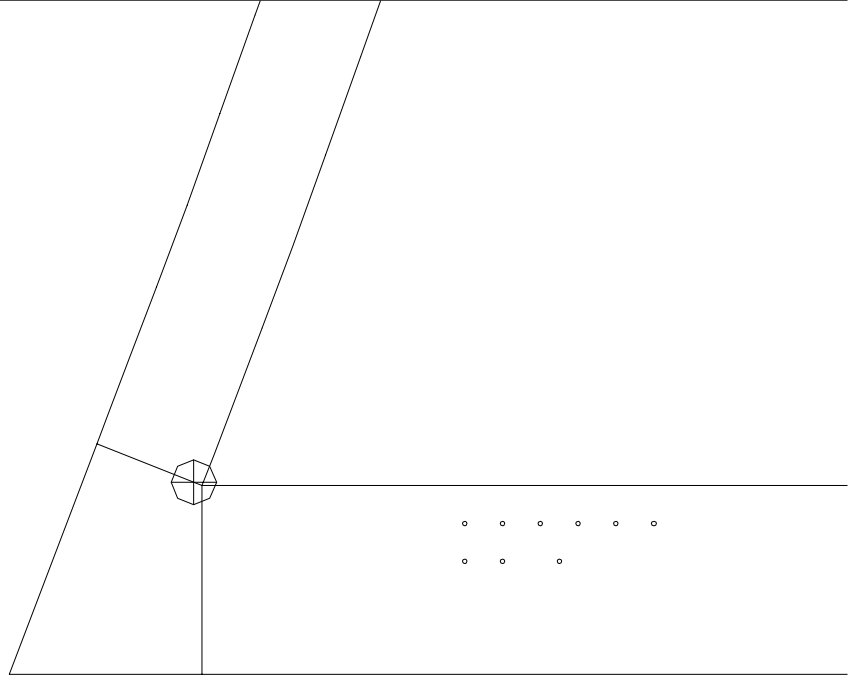

8-23

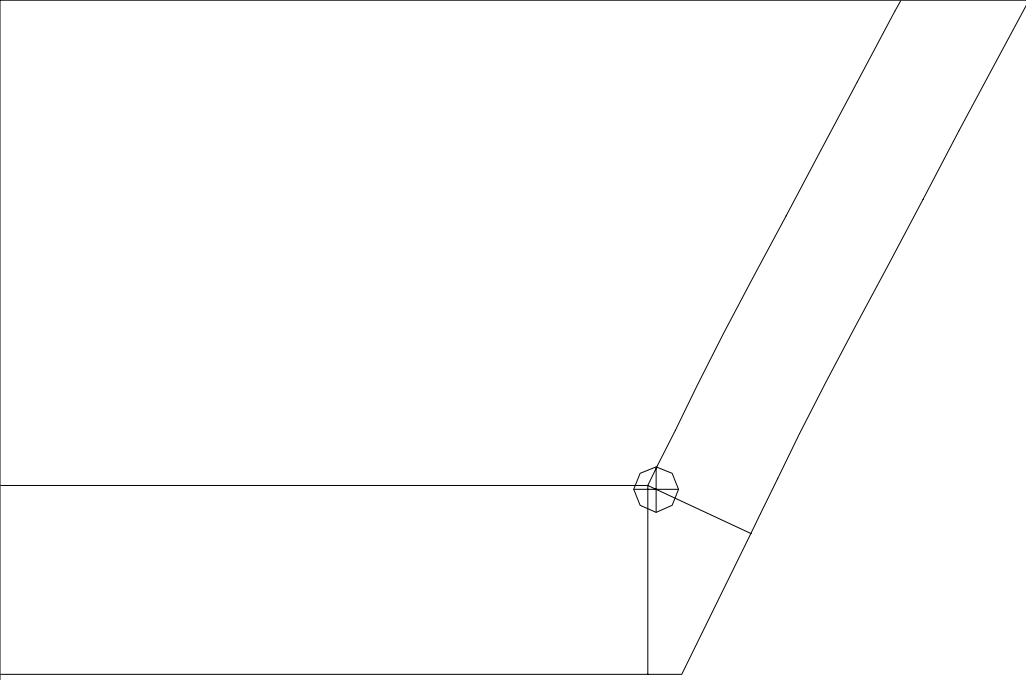

8-24

8-25

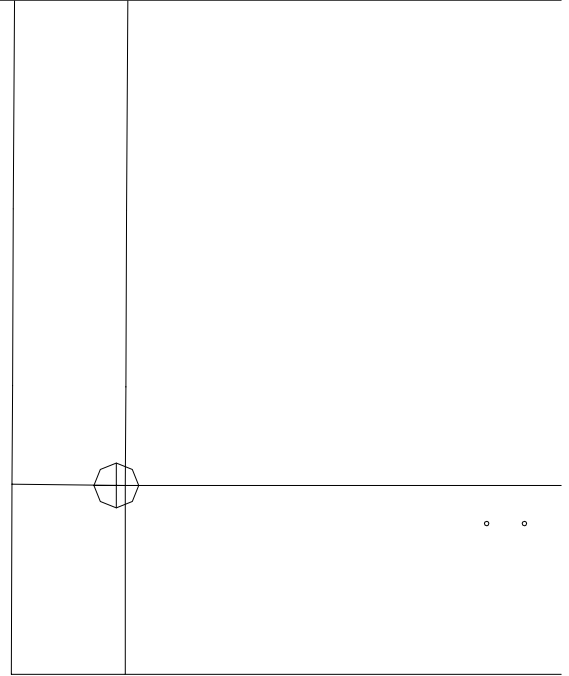
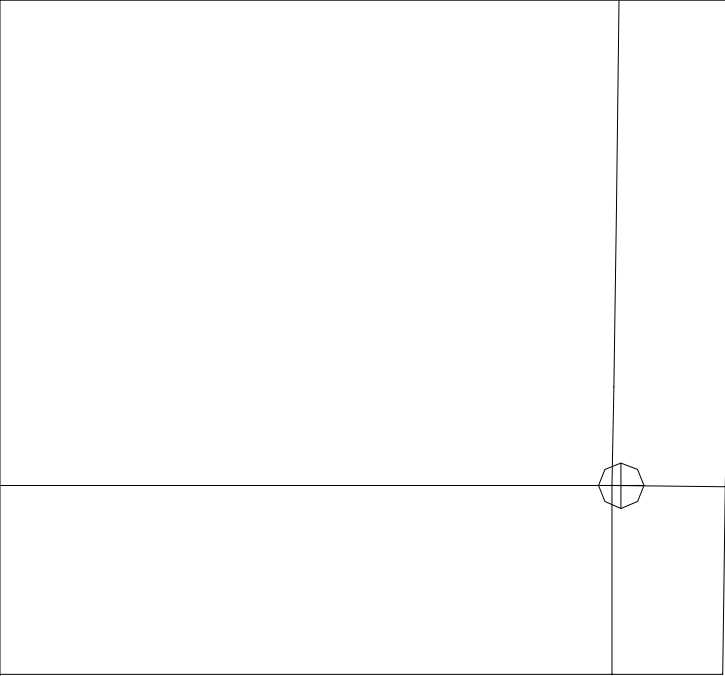

8-2



8-3

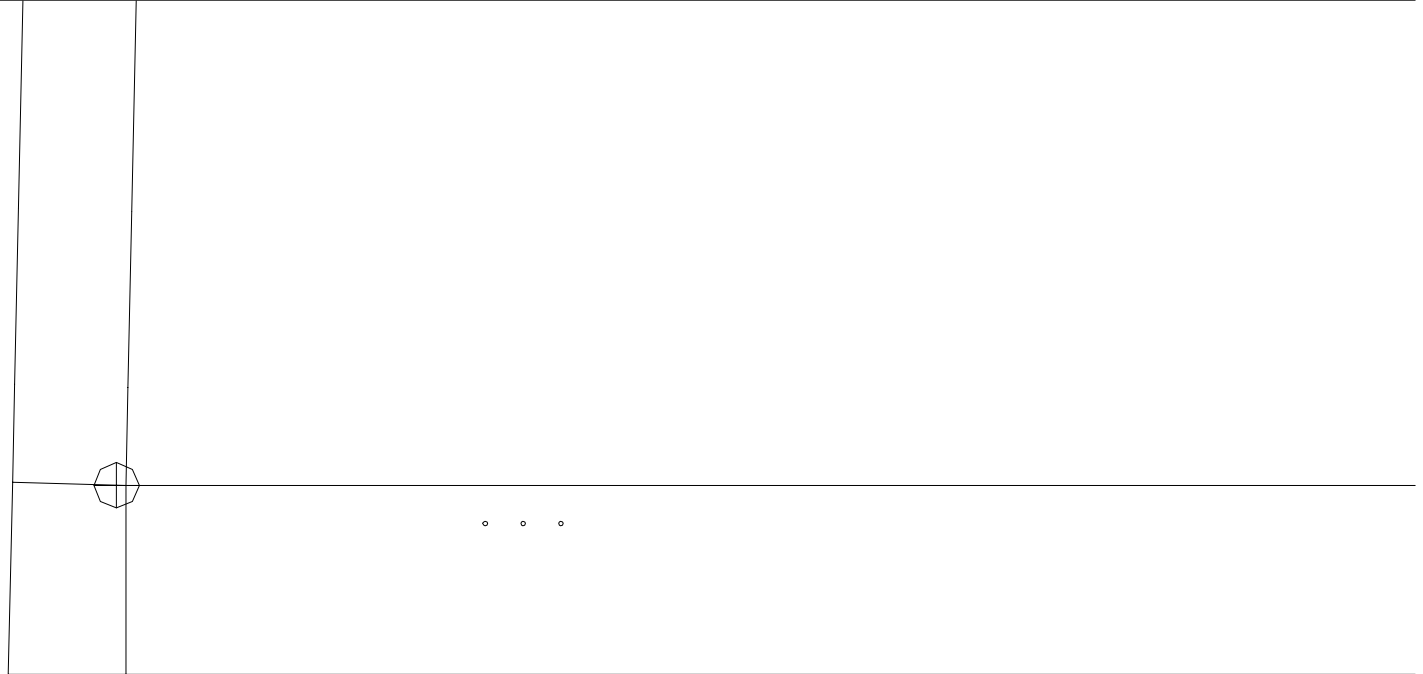

$$8 - 4$$

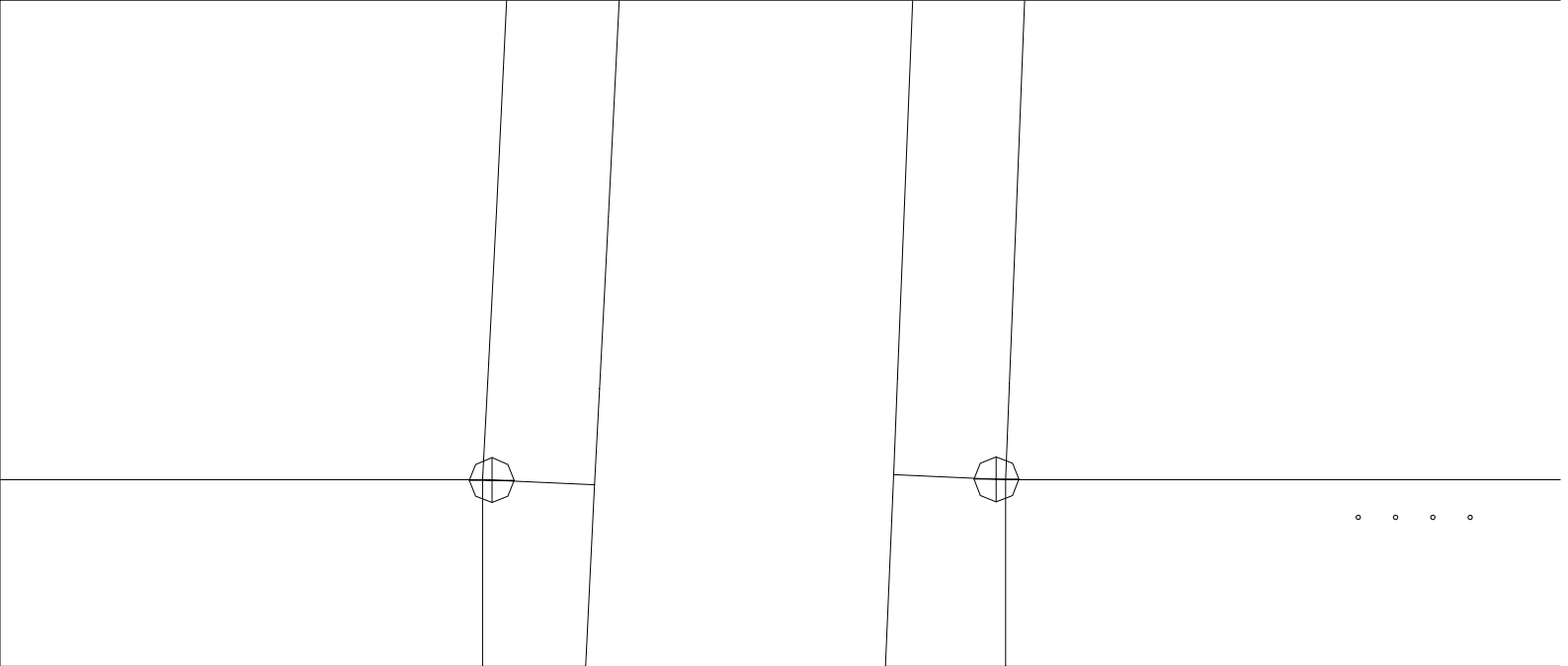

8-5

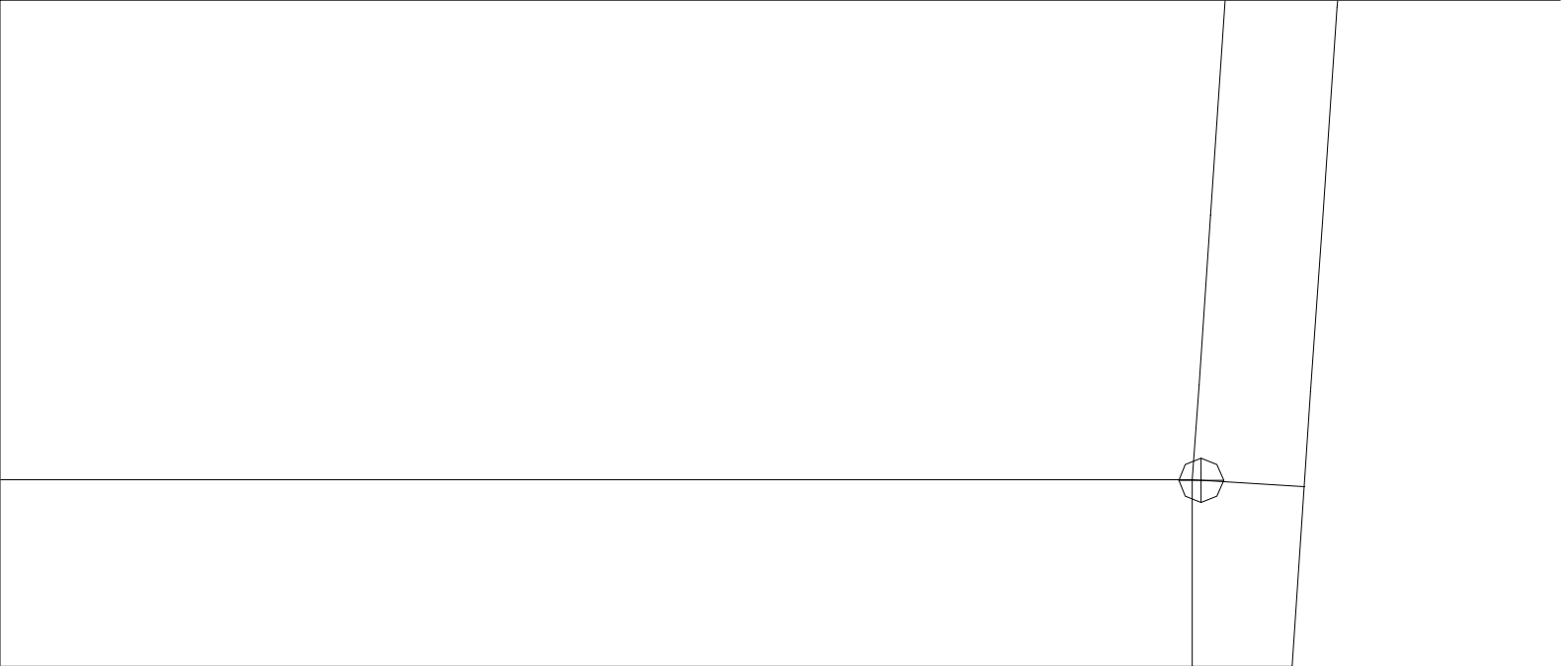

8-6

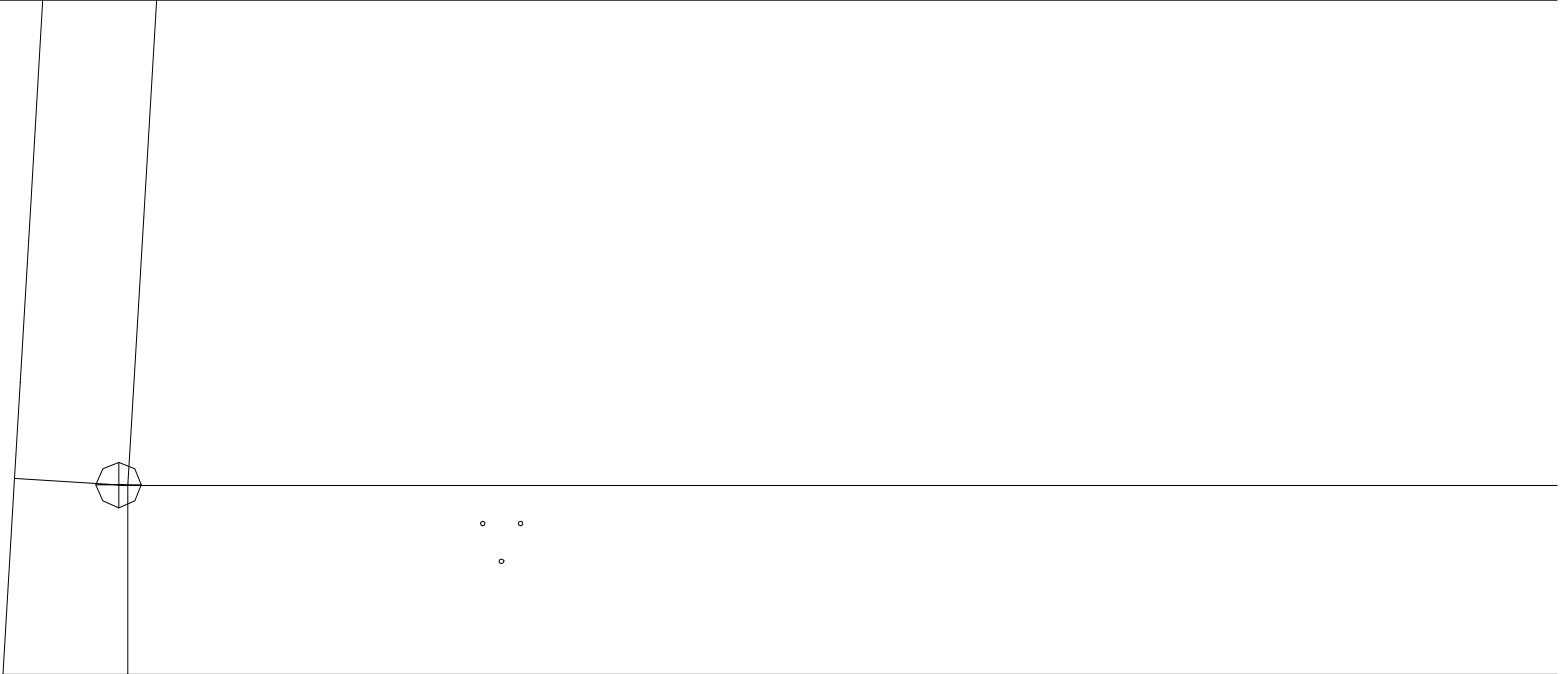

8-7

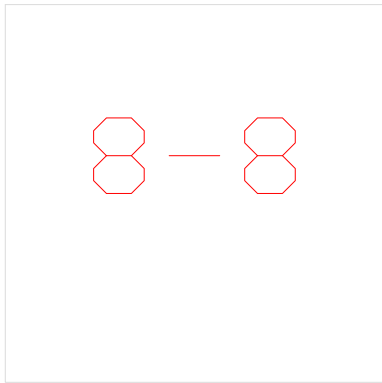
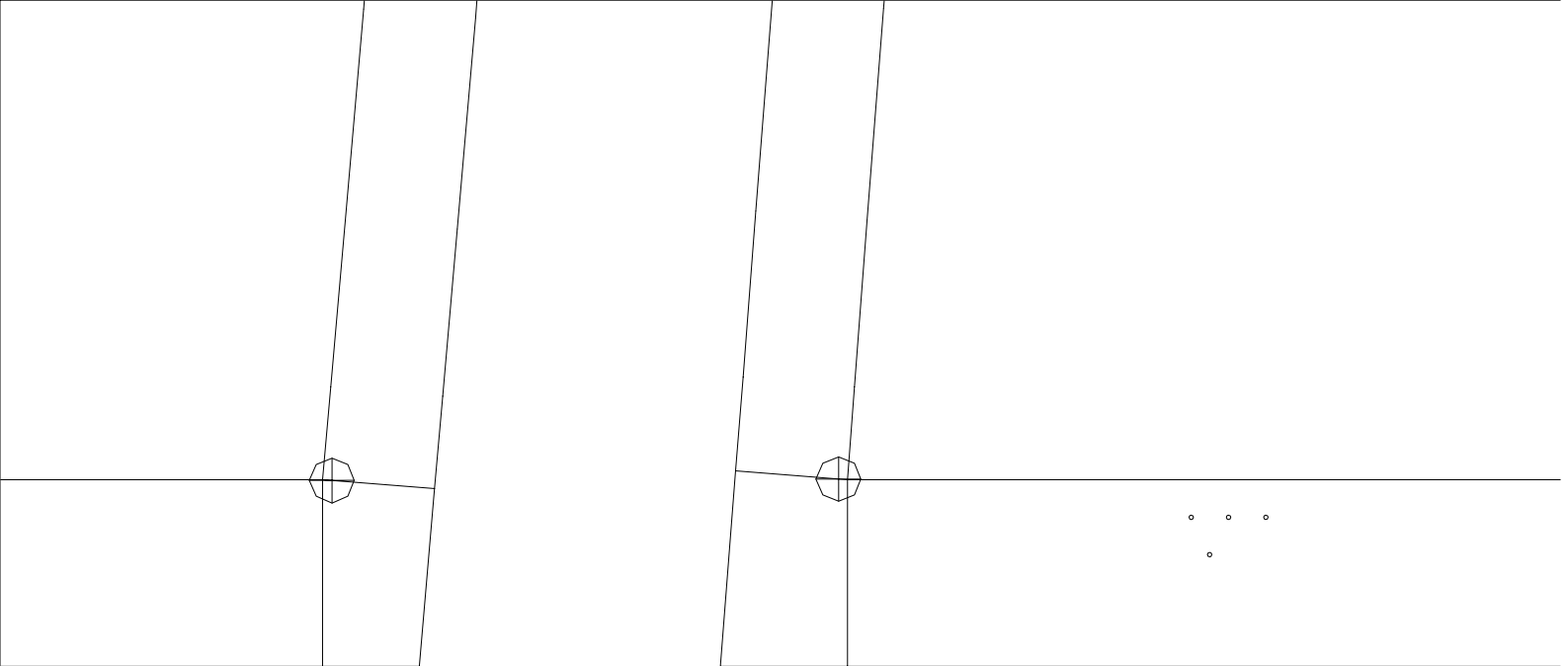

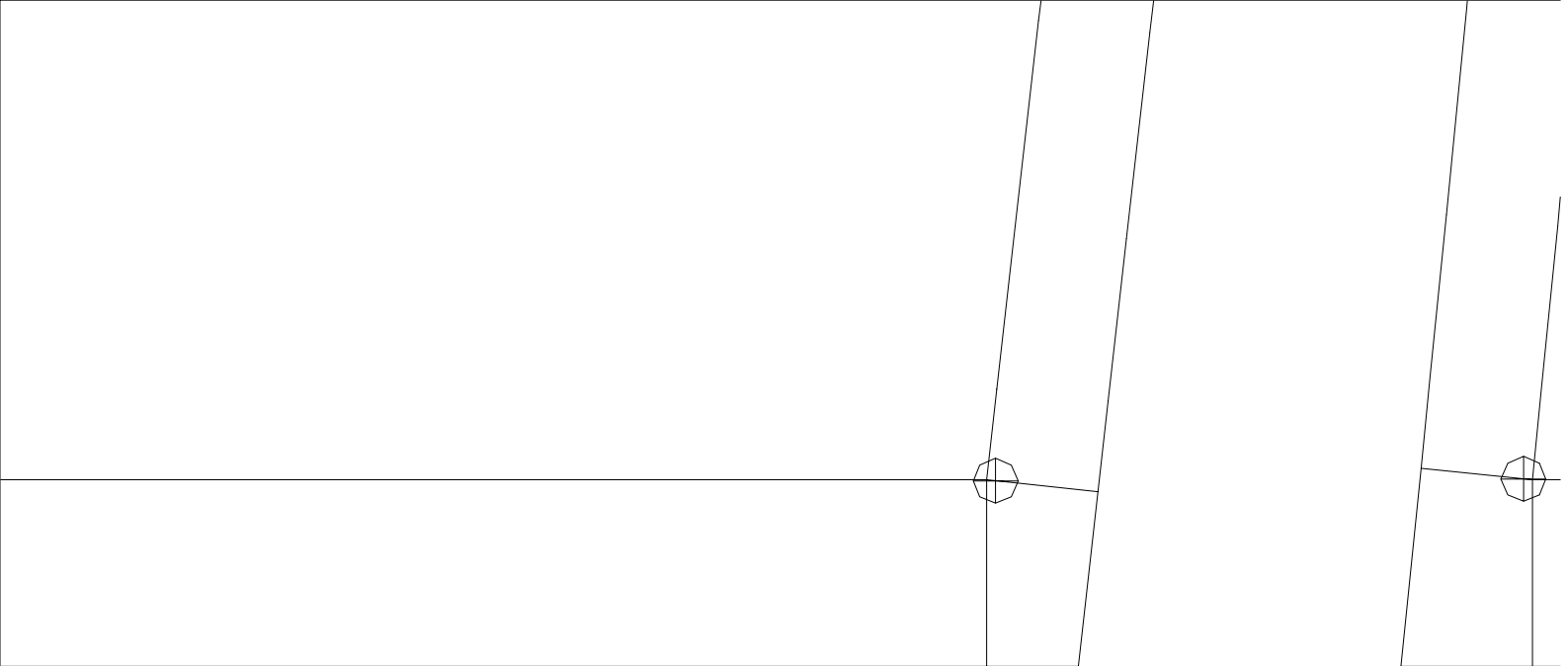

8-9