

200 mm

TEST PAGE

Central square of 50 x 50 mm should be perfectly centered on the page. The pages will be arranged side by side without overlap between them.

With the current settings, I was unable to print 1 mm to the right of the paper, but the space is part of the drawing. Verify that the square is centered!

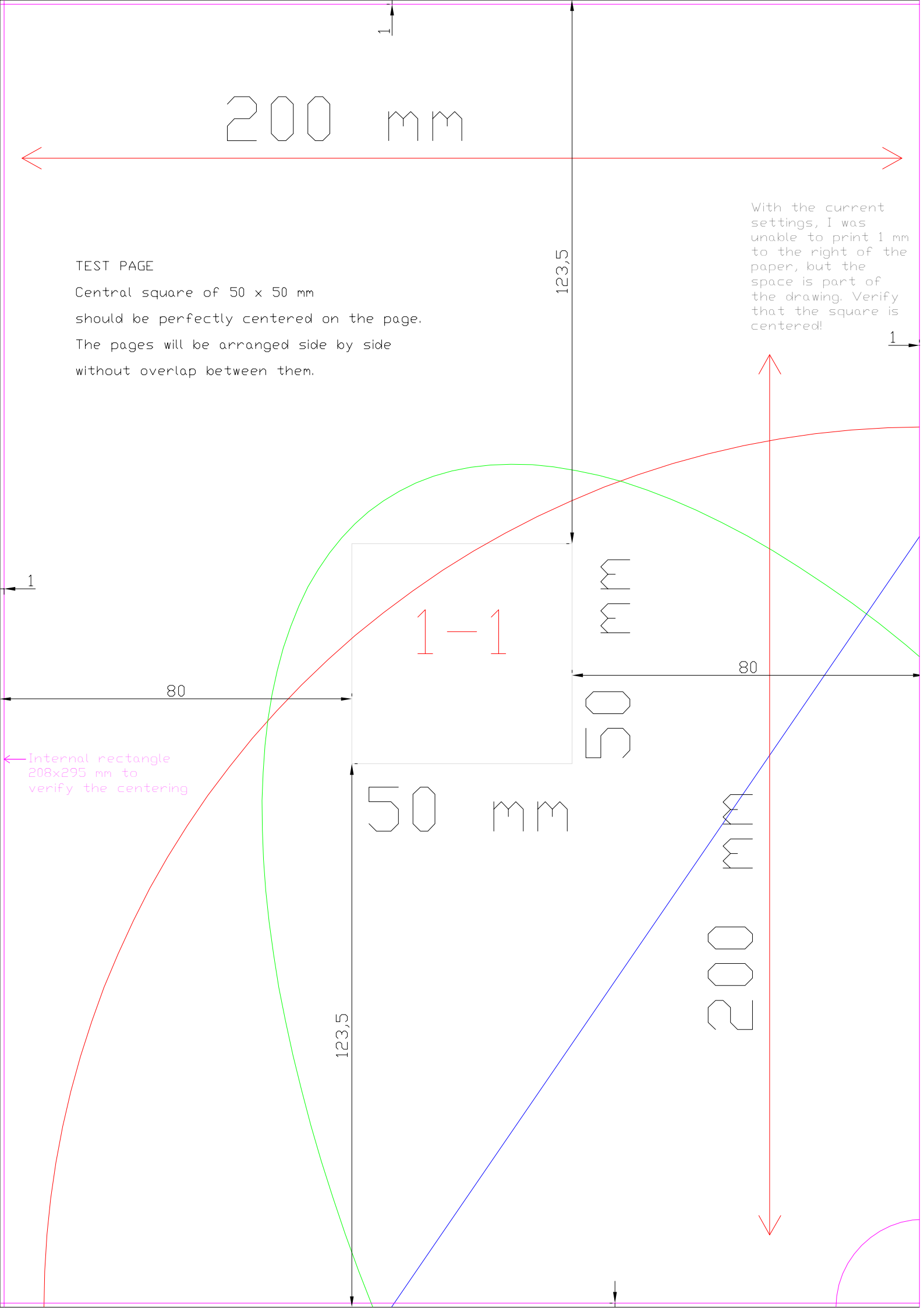

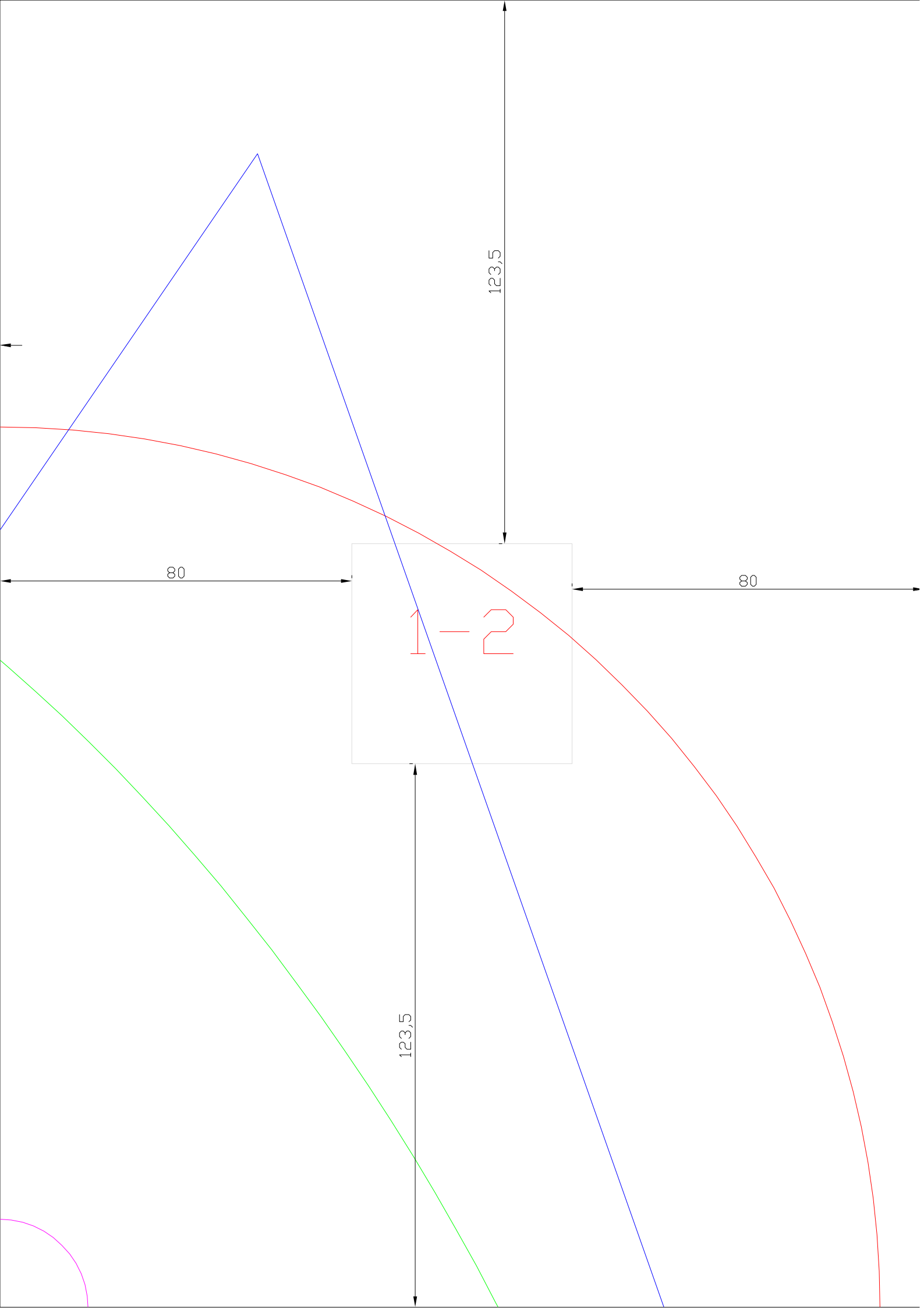

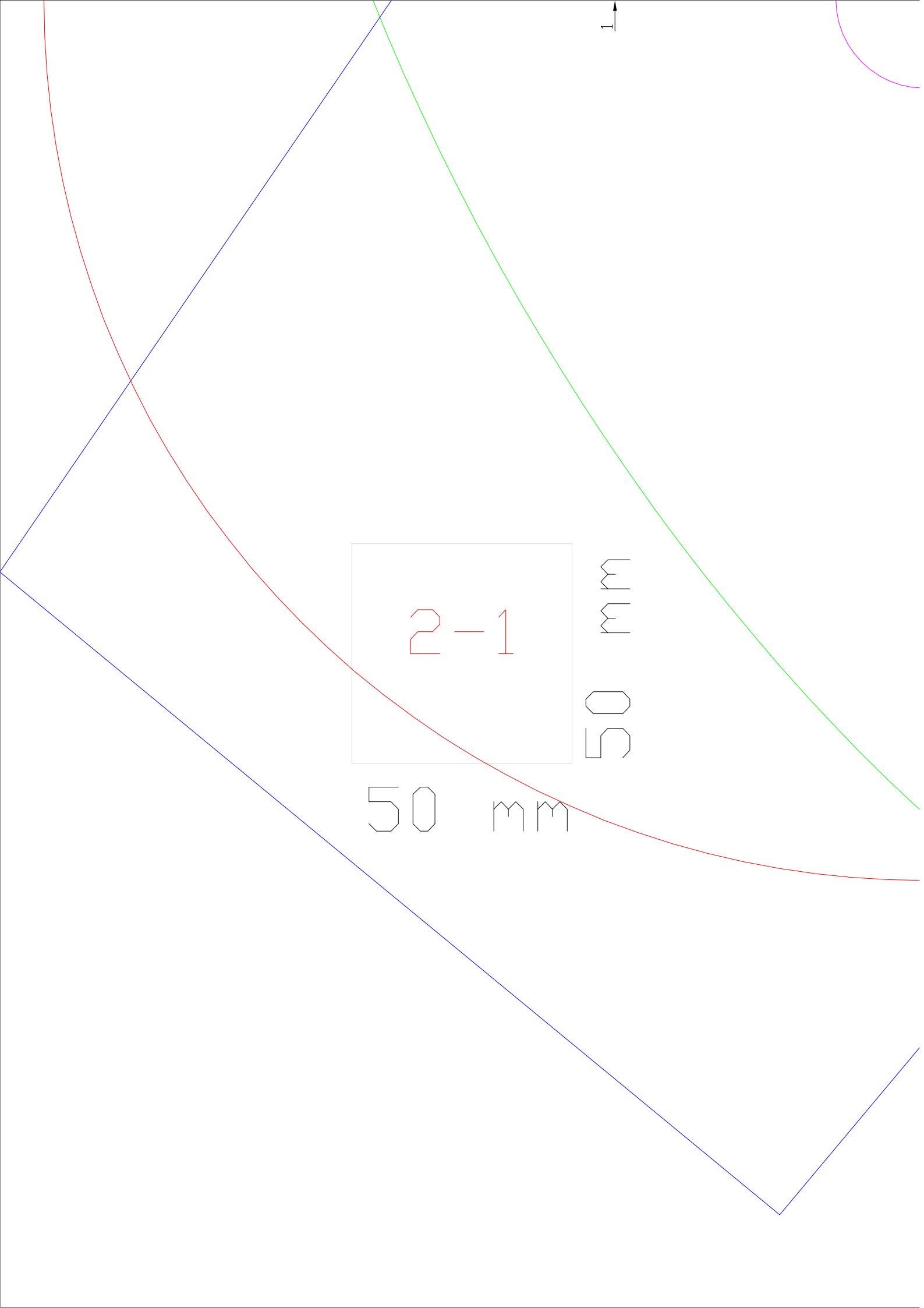



2-2

The image features a central white square with a thin grey border containing the text "2-2" in red. This square is overlaid on a complex background of colored lines: a blue line that curves from the bottom-left towards the top-right; a green line that forms a large, wide arc across the lower half of the page; a red line that curves from the bottom-left towards the top-right, positioned below the blue line; and a purple arc in the top-left corner. The entire composition is set against a plain white background.

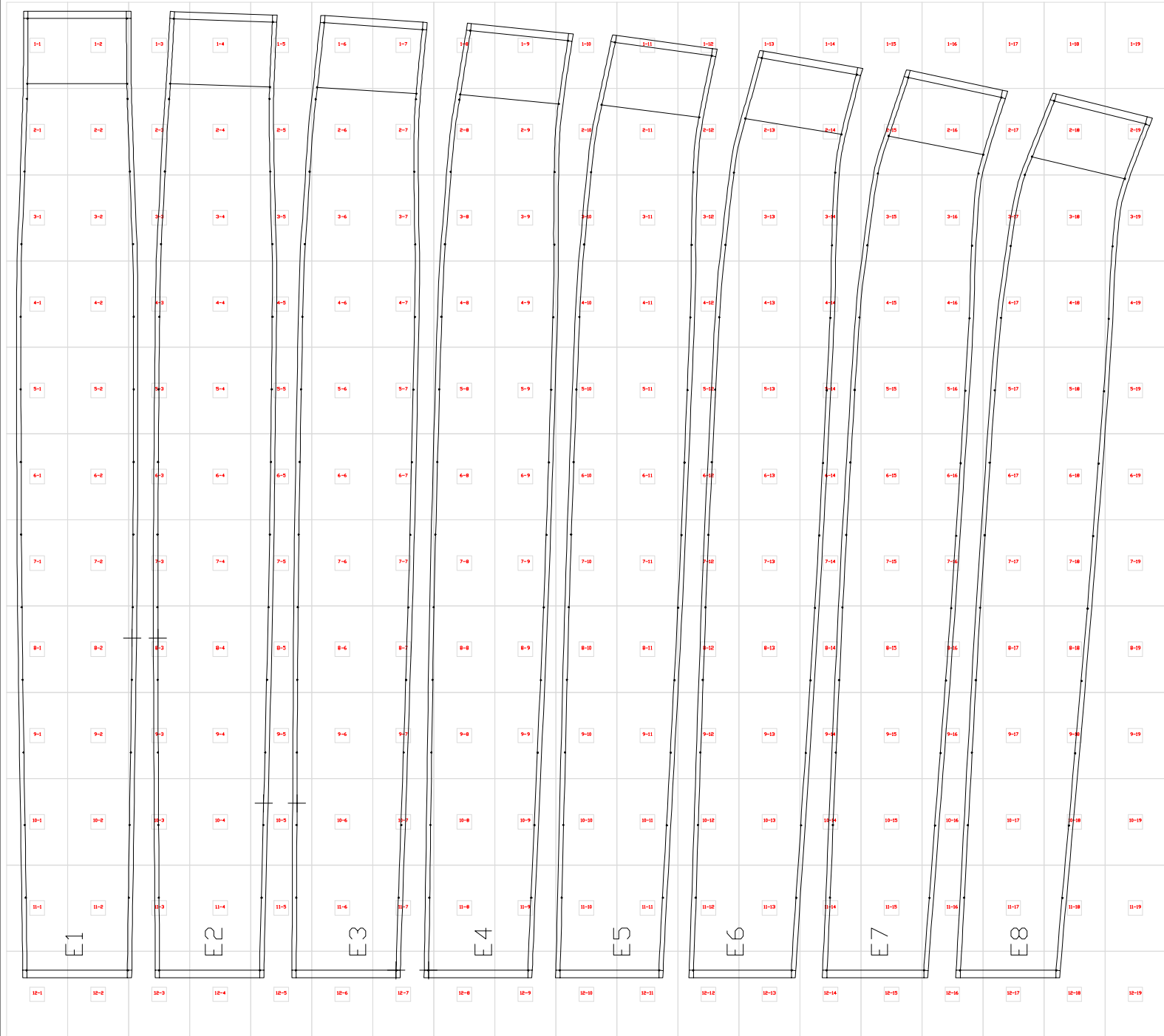



$$10 - 10$$

10-11





10-12

10-13

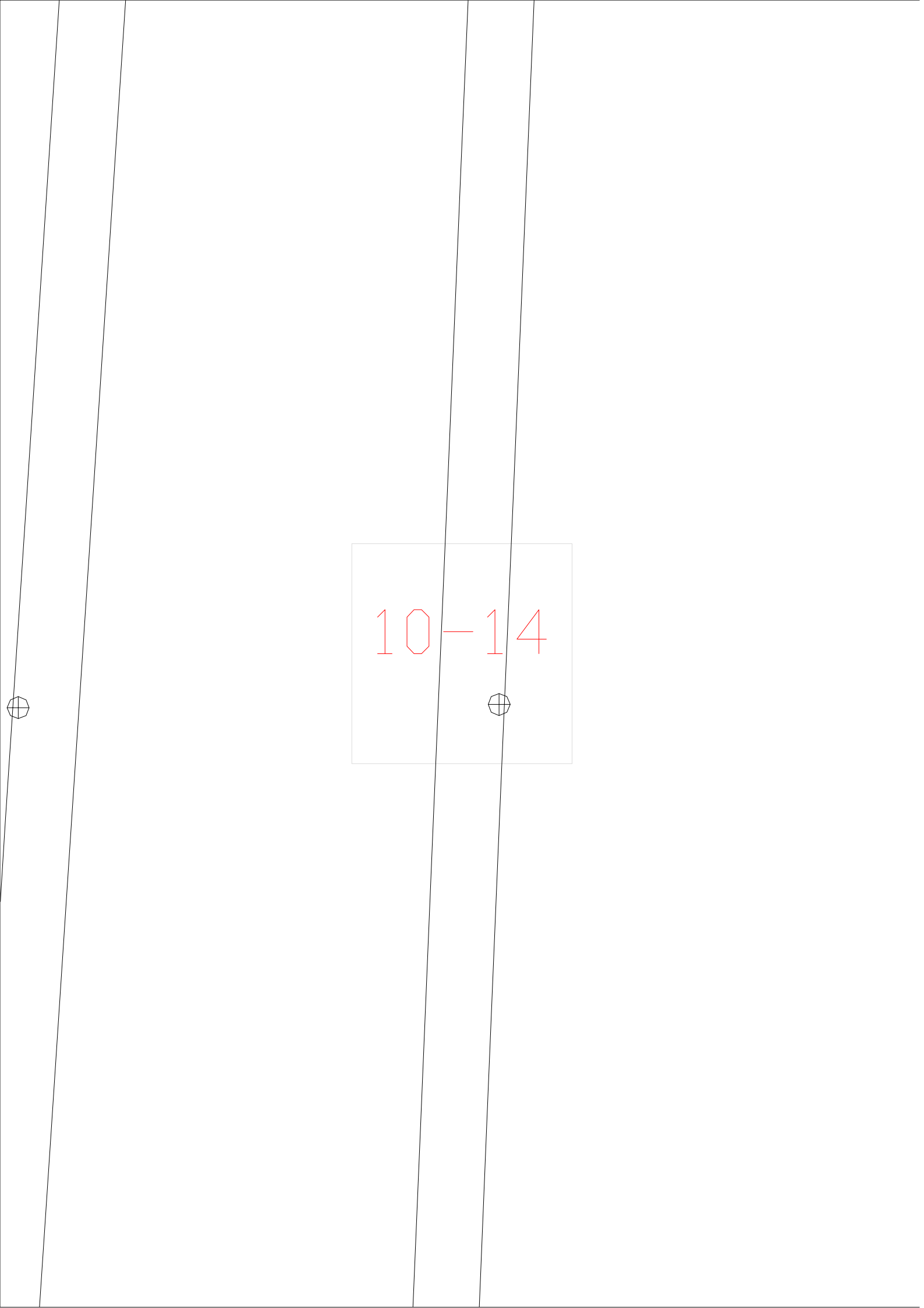

10-14

The image shows a technical drawing of a tapered shaft. The shaft is represented by two parallel lines that converge towards the top, indicating a taper. A central hole is shown as a circle with a crosshair. A rectangular feature is drawn on the shaft, containing the text '10-14' in red. The drawing is oriented vertically.

10-15

10-16

10-17

10-18



10-19



10-1

10-2

10-3



$$10 - 4$$

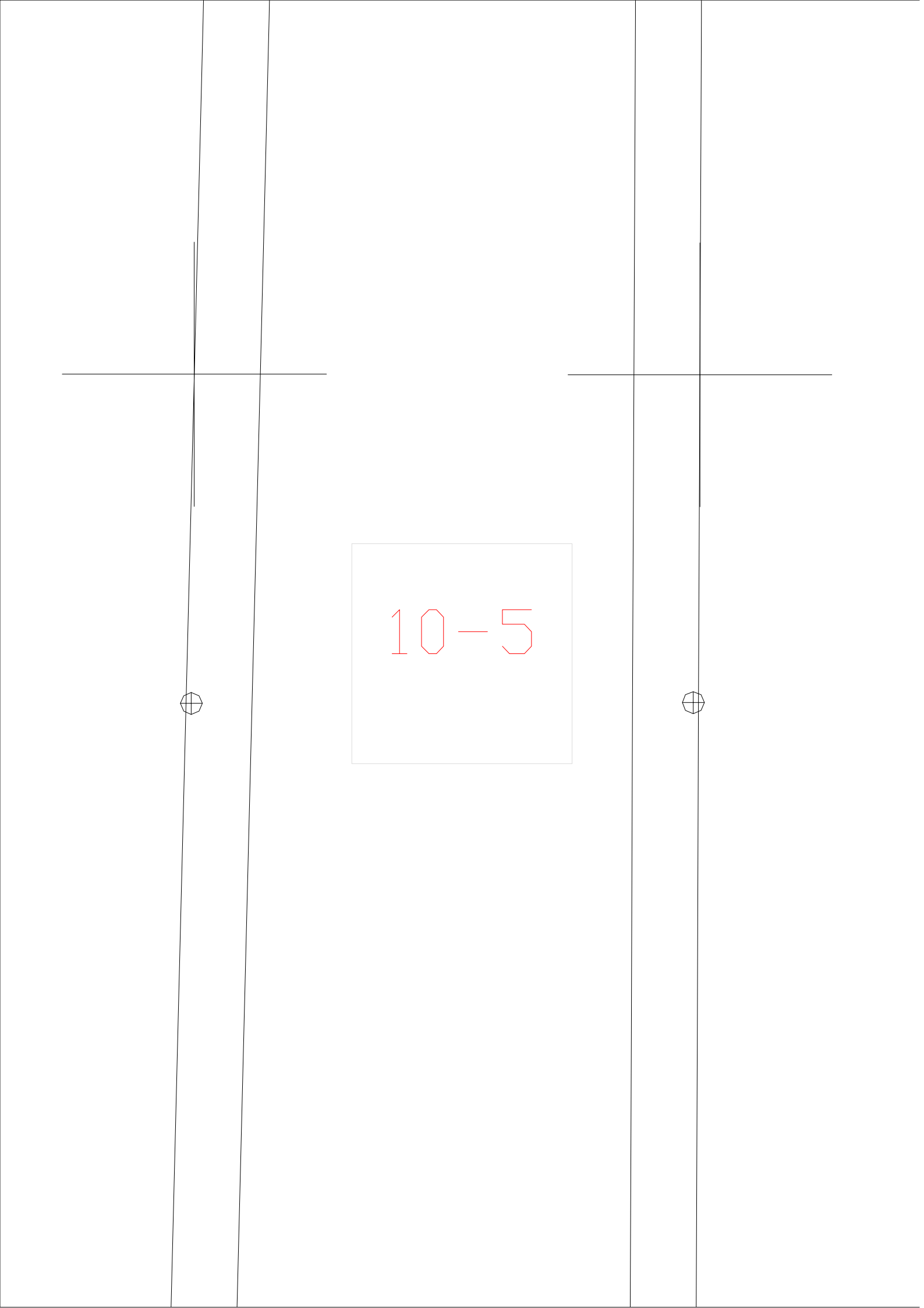

10-5

The image shows a technical drawing of a vertical shaft. The shaft is represented by two vertical lines, with a central hole indicated by a circle with a cross inside. A horizontal line crosses the shaft at the top. A central rectangular box contains the text '10-5' in red.

10-6

$$10 - 7$$



$$10 - 8$$

10-9



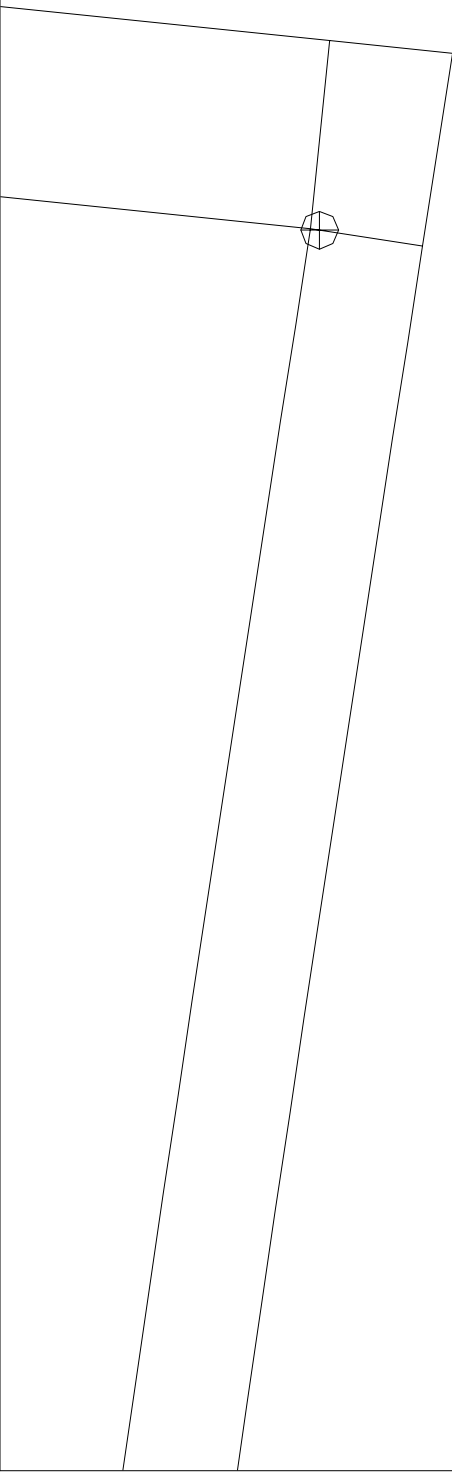

1-10

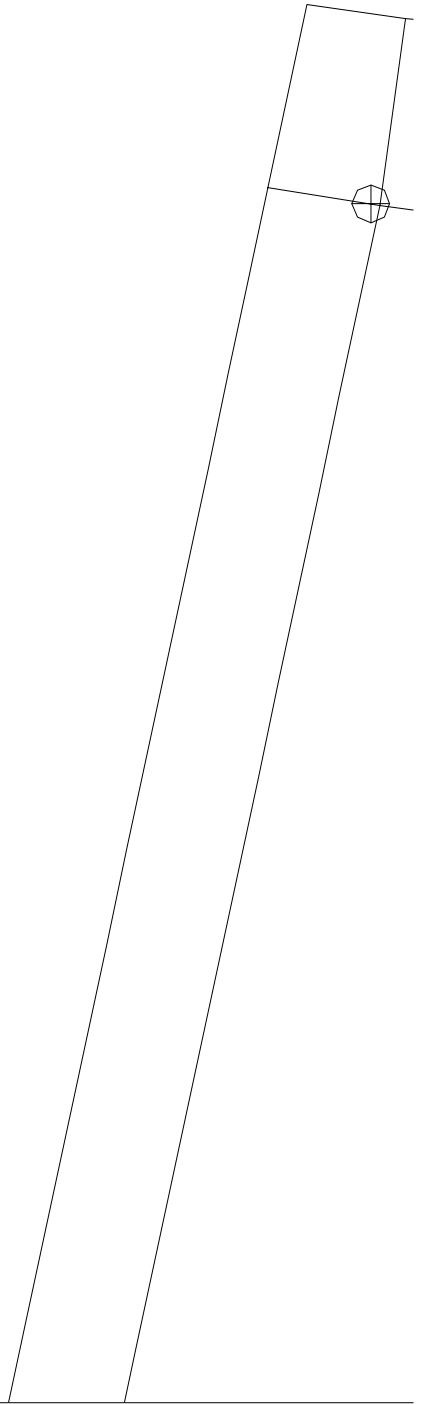



11-10

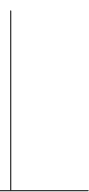
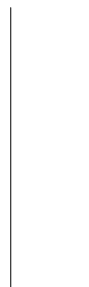

11-11

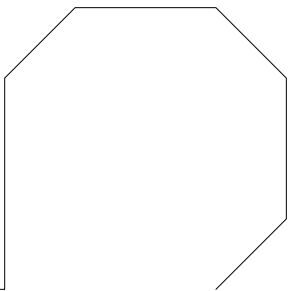



11-12

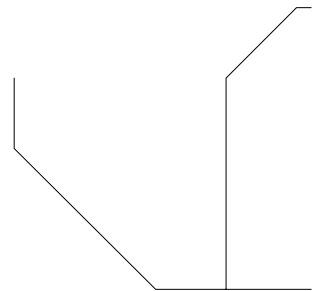

11-13

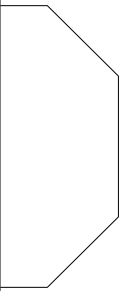



11-14

11-15

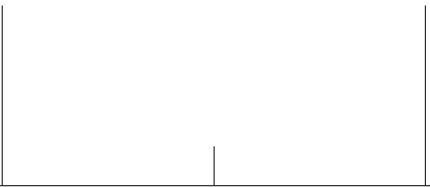
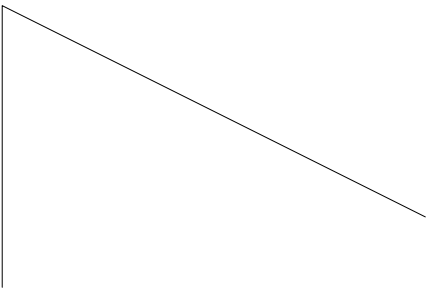



11-16

11-17

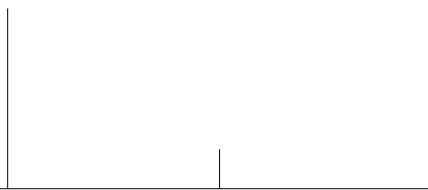
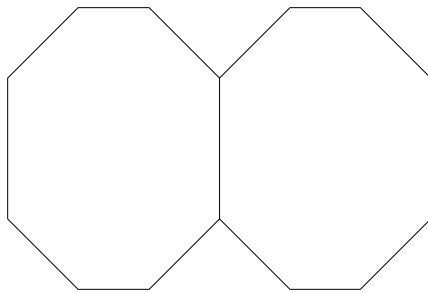



11-18

11-19

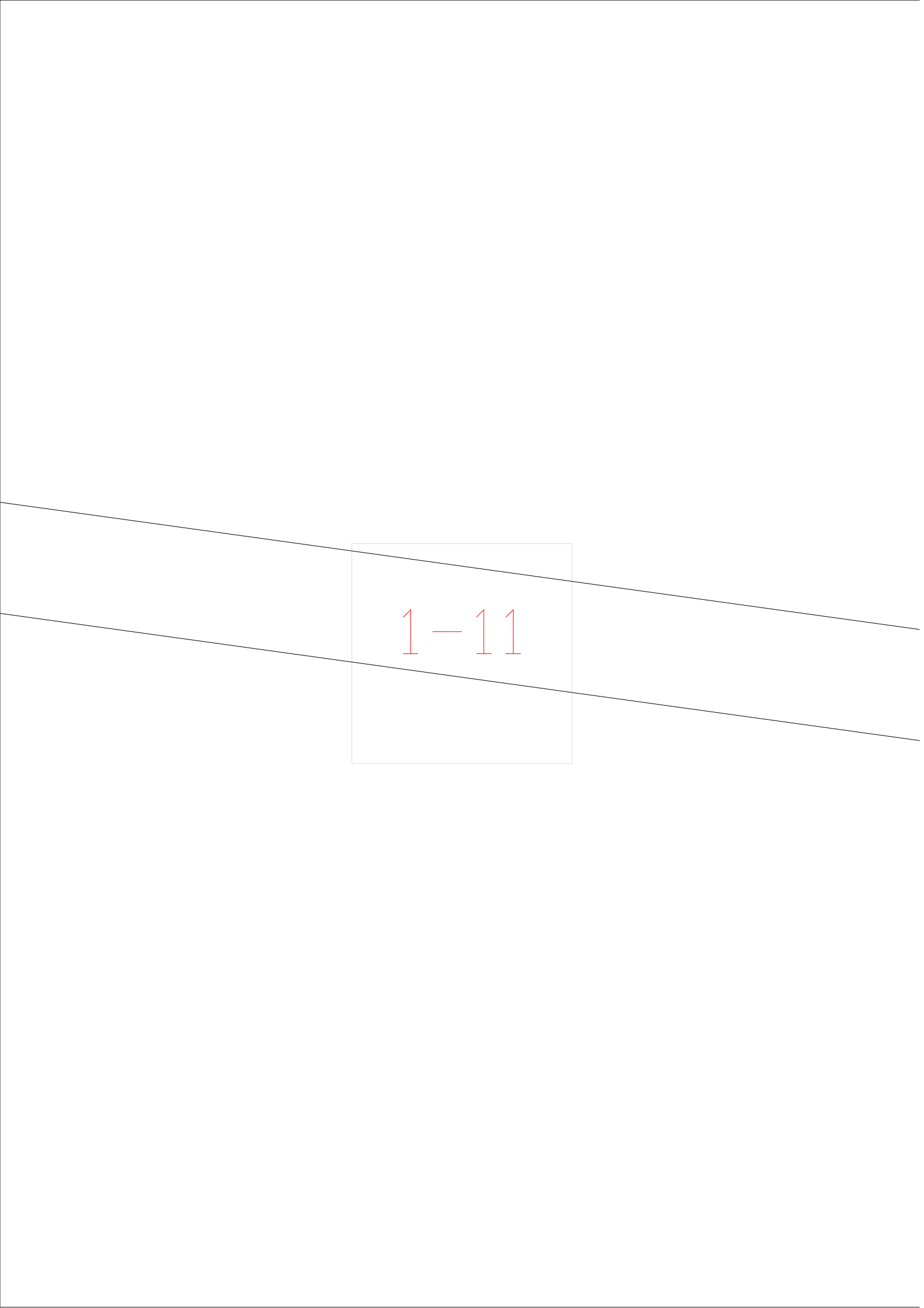

1-11



11-1



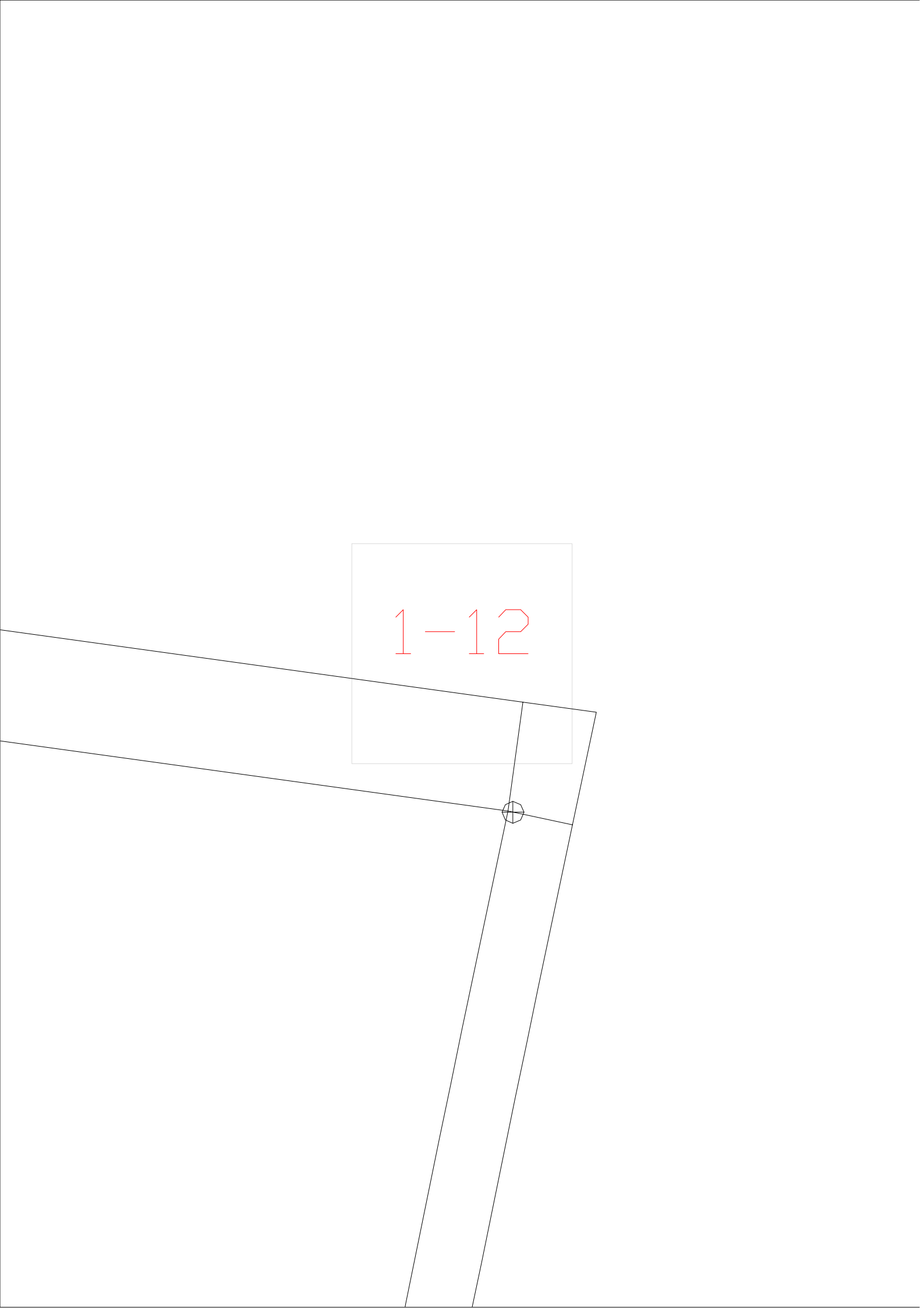

1-12

The image shows a technical drawing of a mechanical component, possibly a bracket or a support arm. The drawing is composed of several lines: a vertical line on the left, a horizontal line at the top, and two parallel lines that converge towards the right, forming a trapezoidal shape. A circular feature, likely a hole or a fastener, is located on the lower right side of the component. A rectangular callout box with a thin border is positioned above the component, containing the text '1-12' in red. The background is white.

11-2

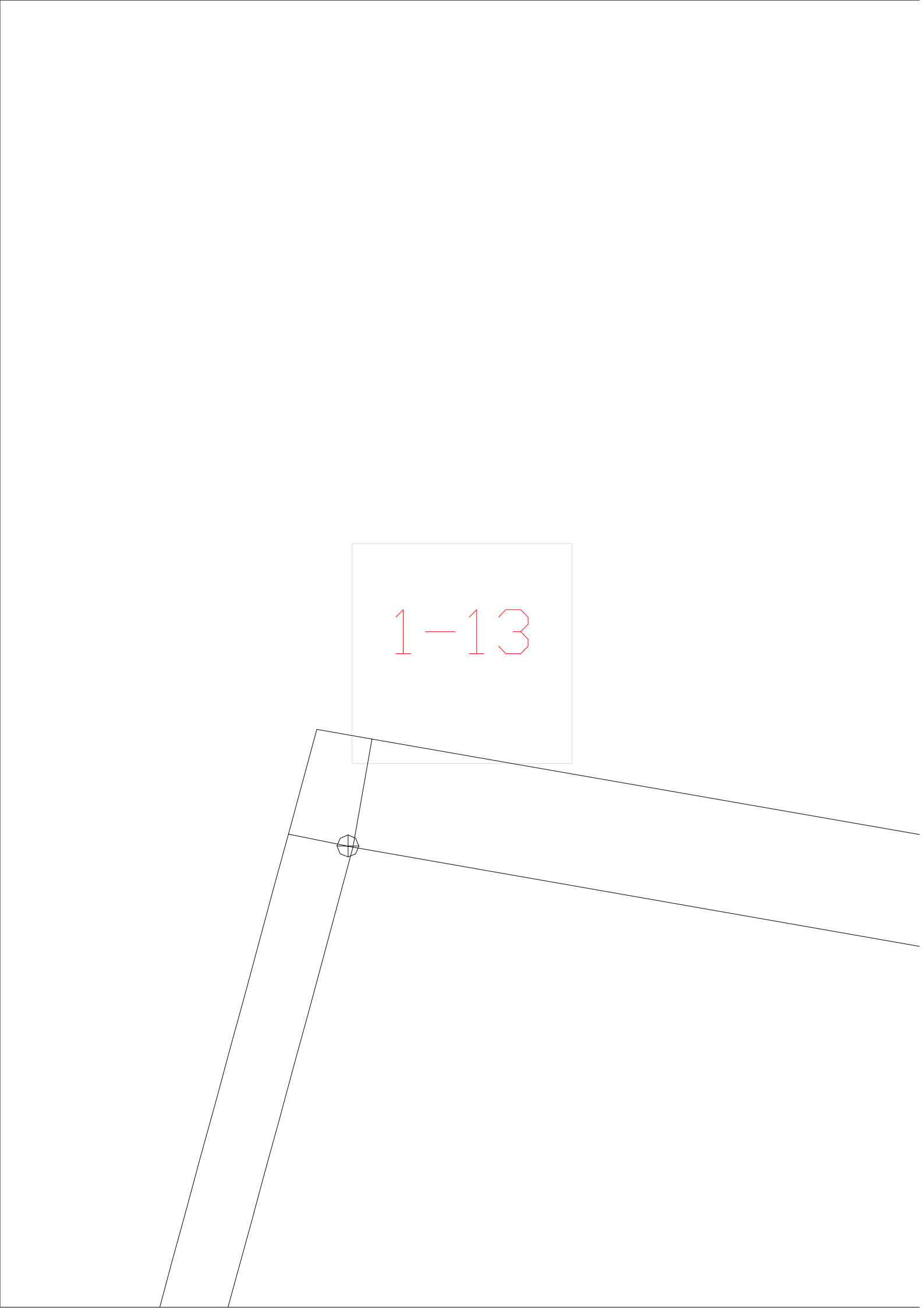

1-13

The image shows a technical drawing of a bent pipe or duct. The pipe starts at the bottom left, bends upwards and to the right, and then bends again to become more horizontal. A small circle with a cross inside, representing a bolt or fastener, is located at the first bend. A rectangular callout box with a thin border is positioned above the pipe, containing the text '1-13' in red. The drawing is composed of simple black lines on a white background.



11-3

1-14



11-4

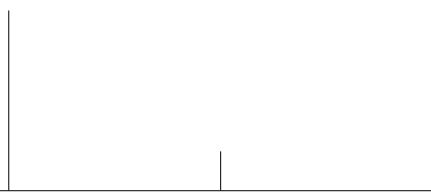
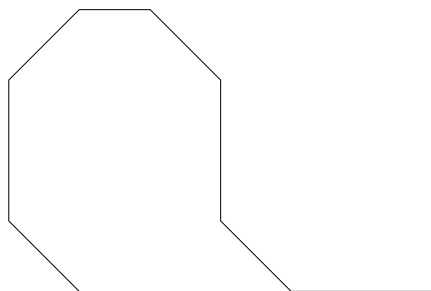

1-15

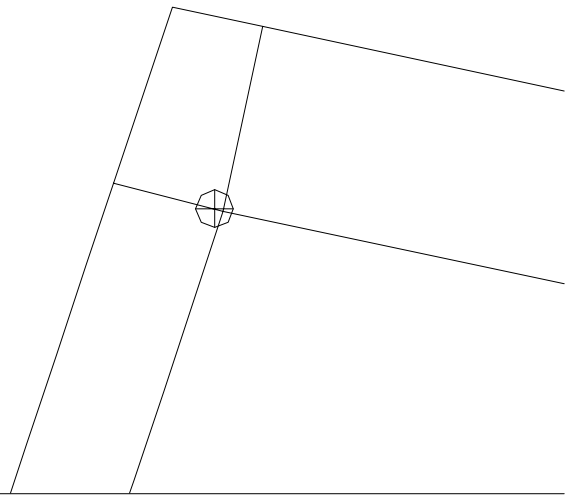

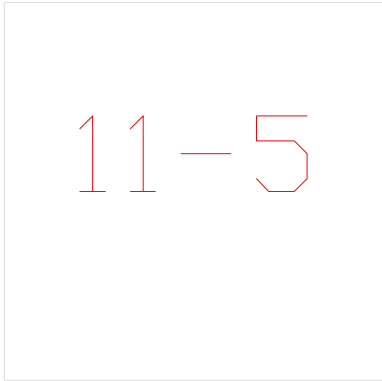

11-5

1-16

11-6

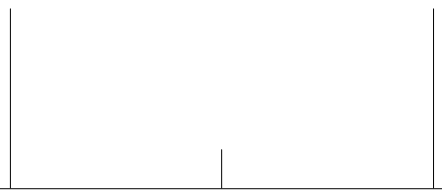
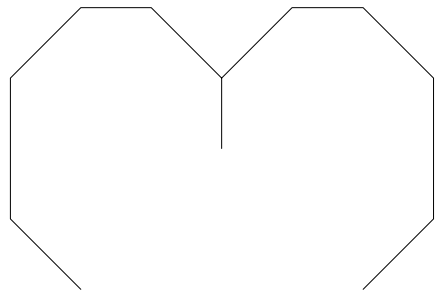

1-17



$$11 - 7$$



1-18

$$11 - 8$$

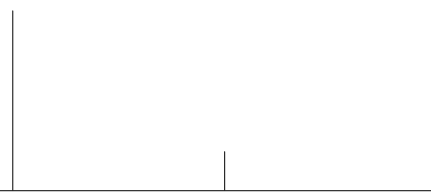
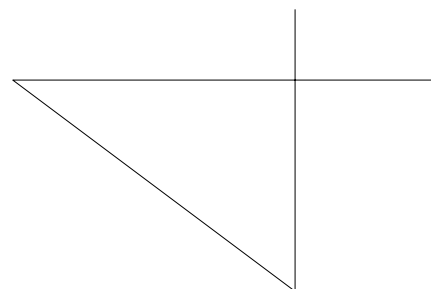

1-19



11-9

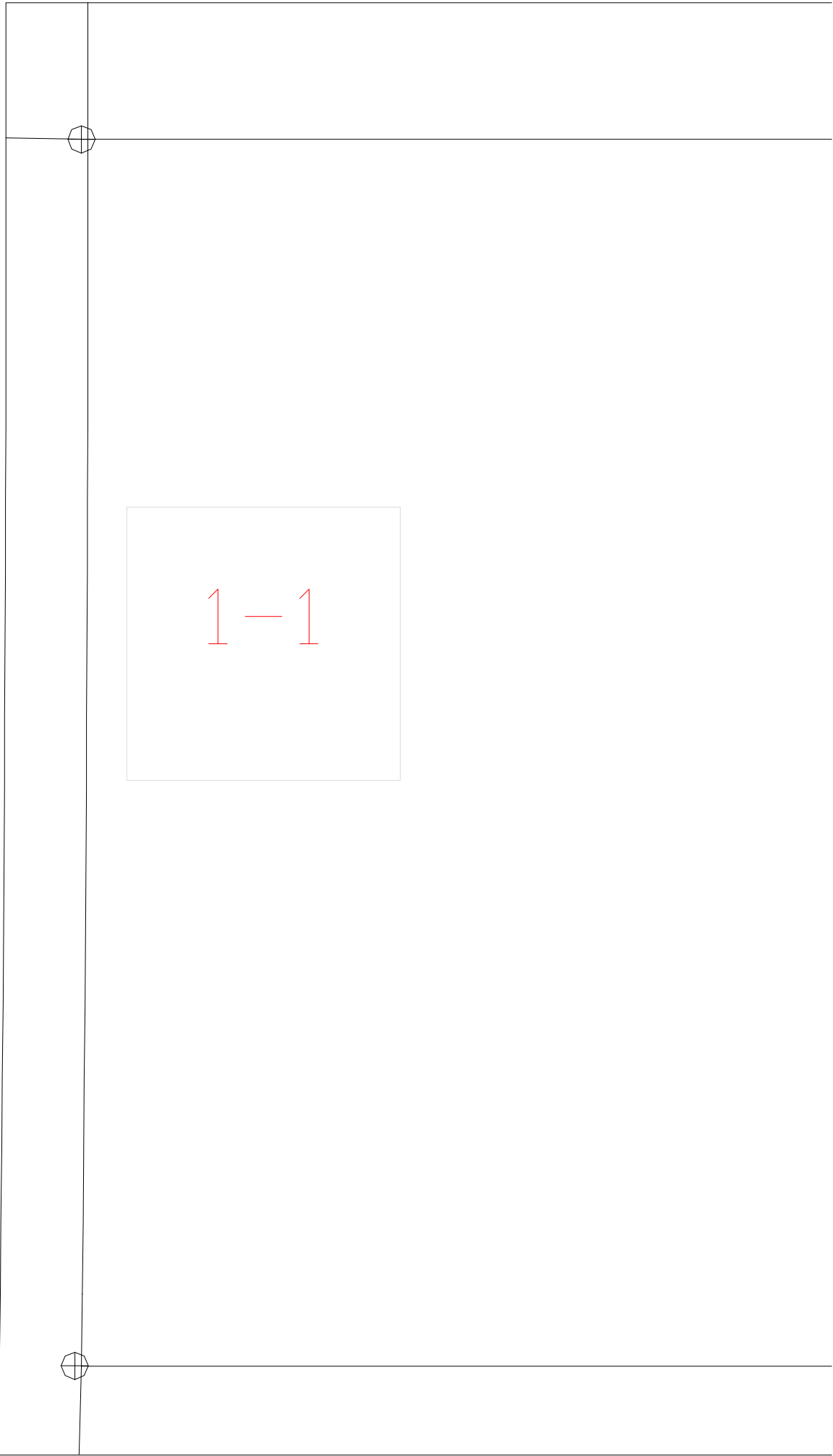

12-10



12-11

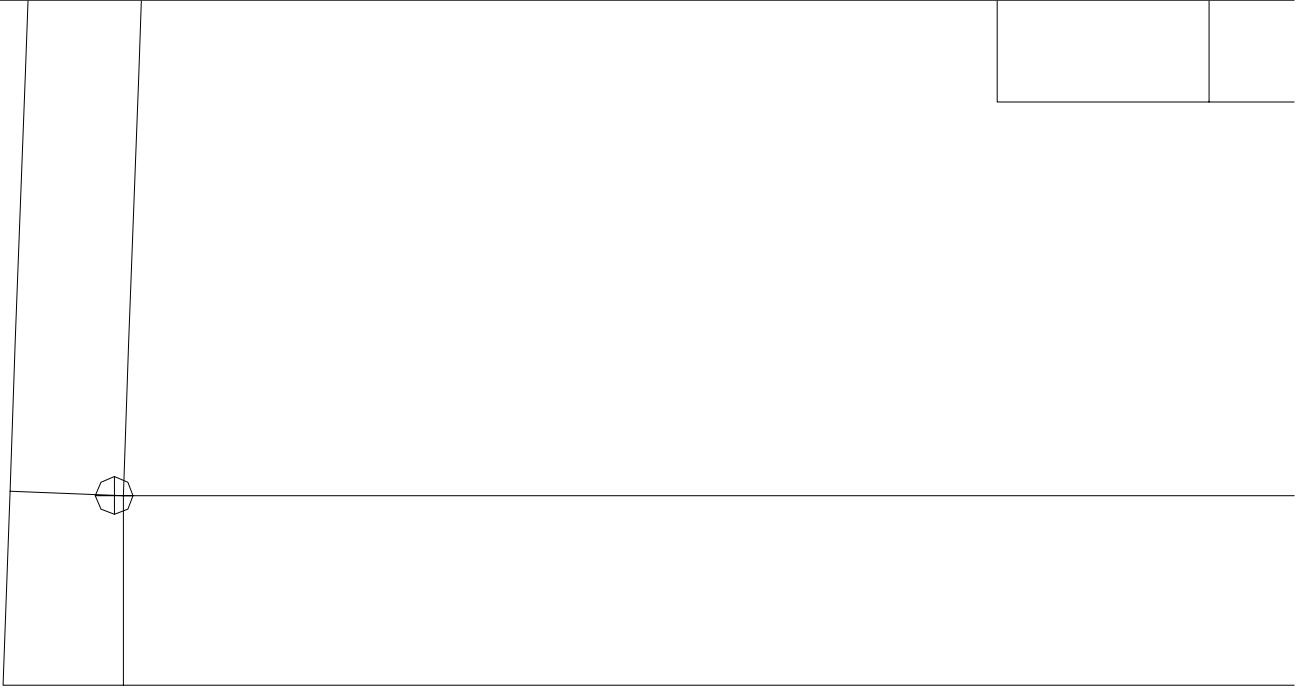

12-12

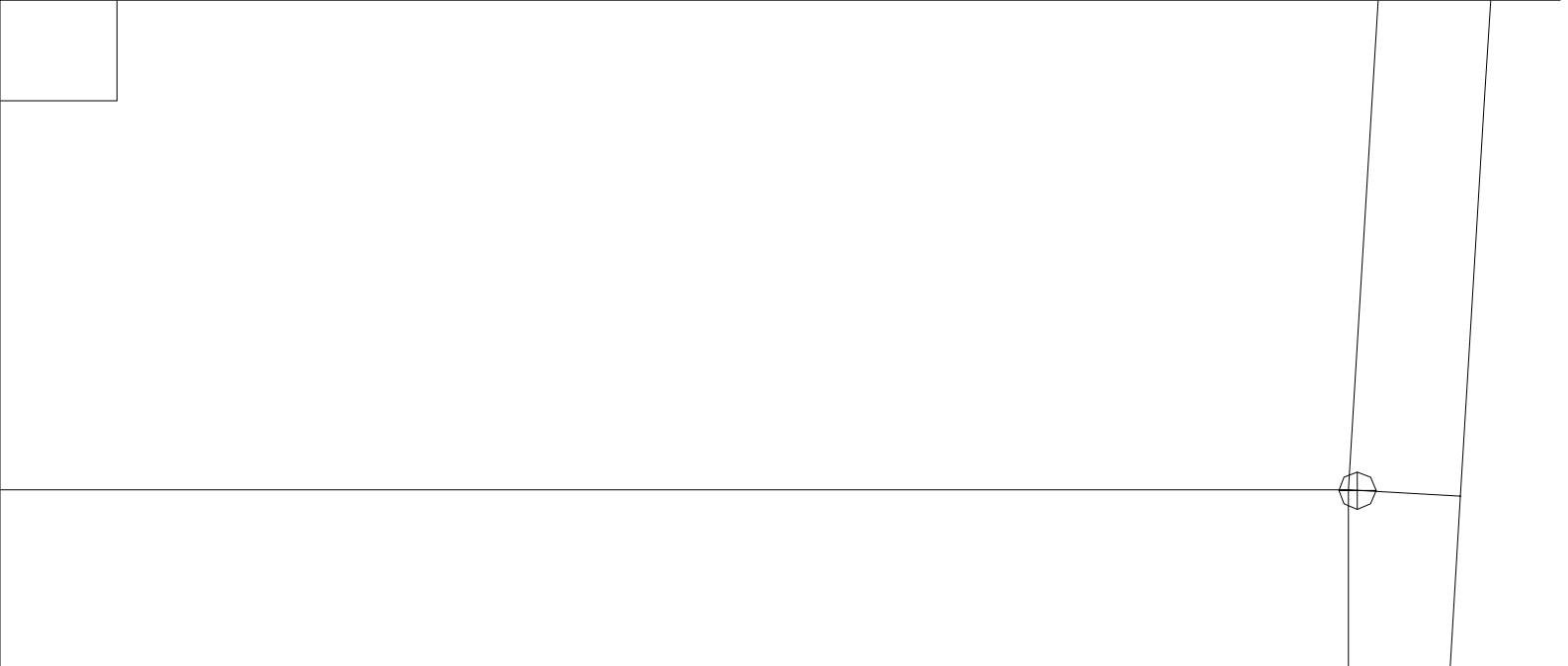

12-13

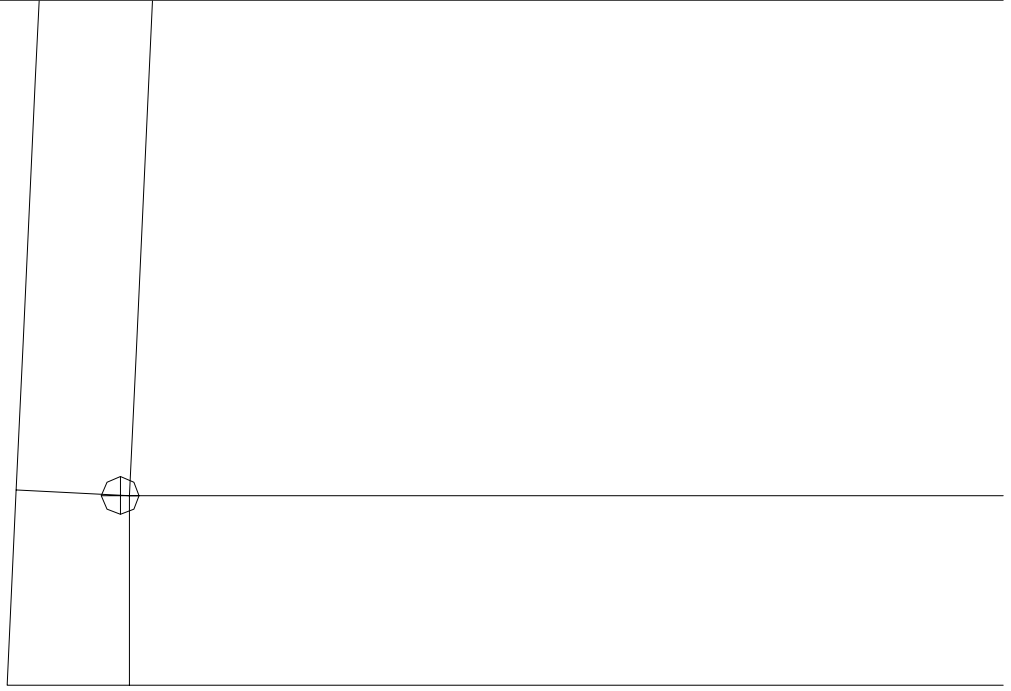

12-14

--	--

12-15

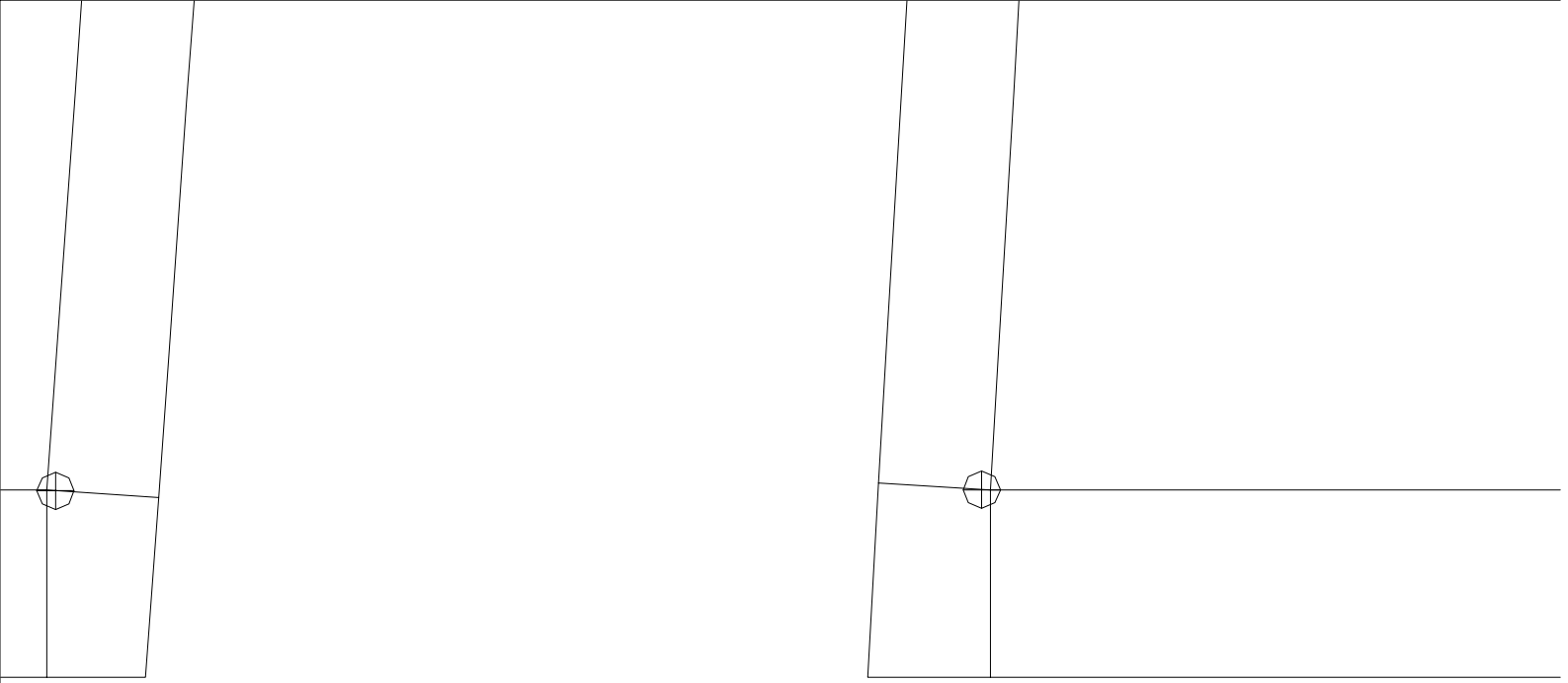

12-16

--	--

12-17

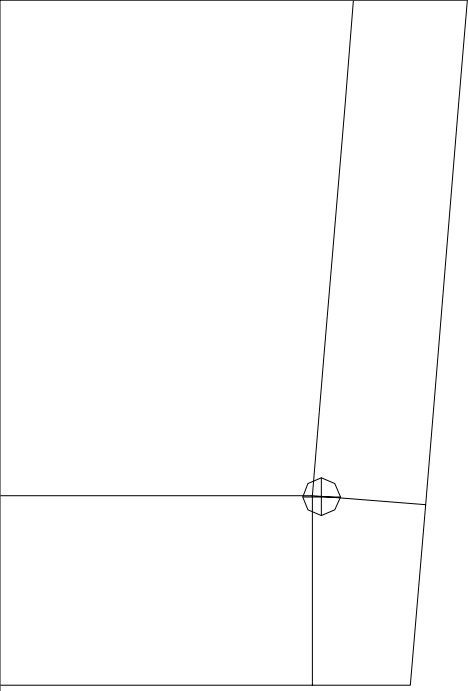

12-18

12-19

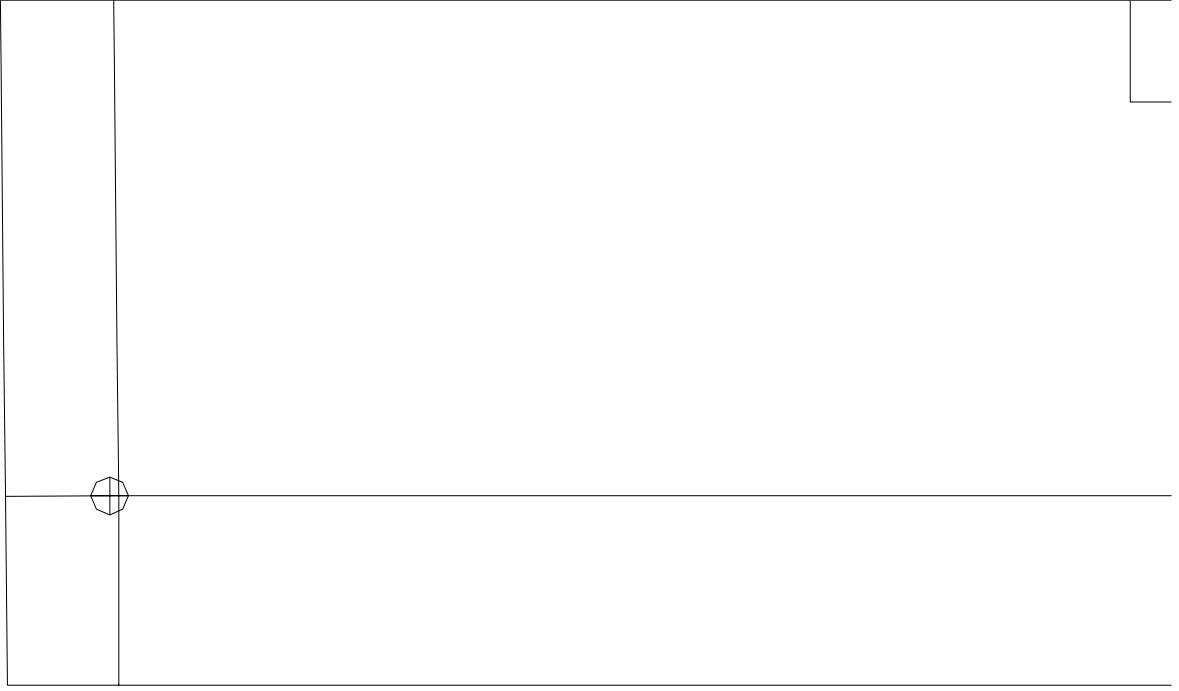

12-1

12-2



12-3

--	--

$$12 - 4$$

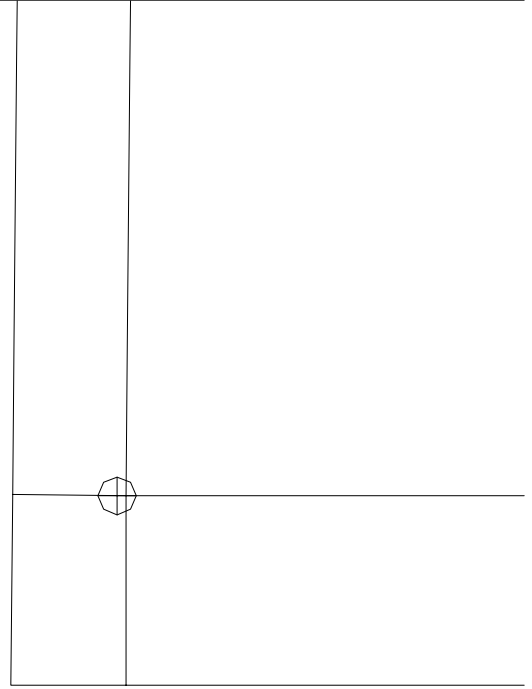
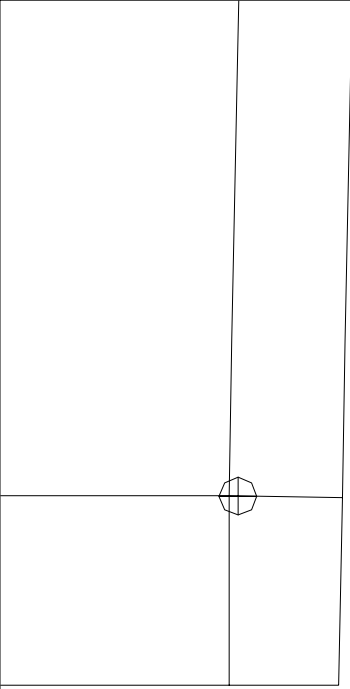

$$12 - 5$$

--	--

12-6

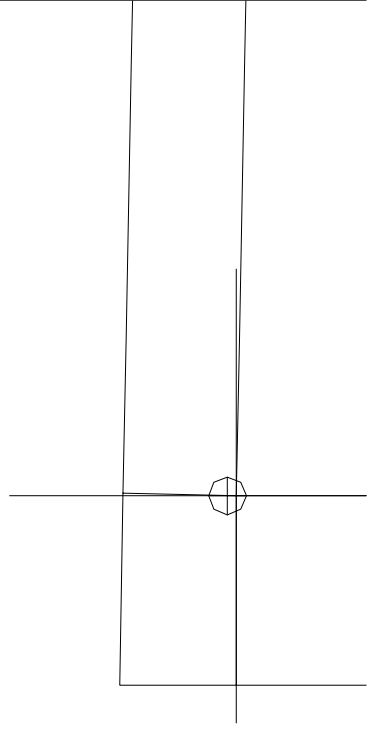
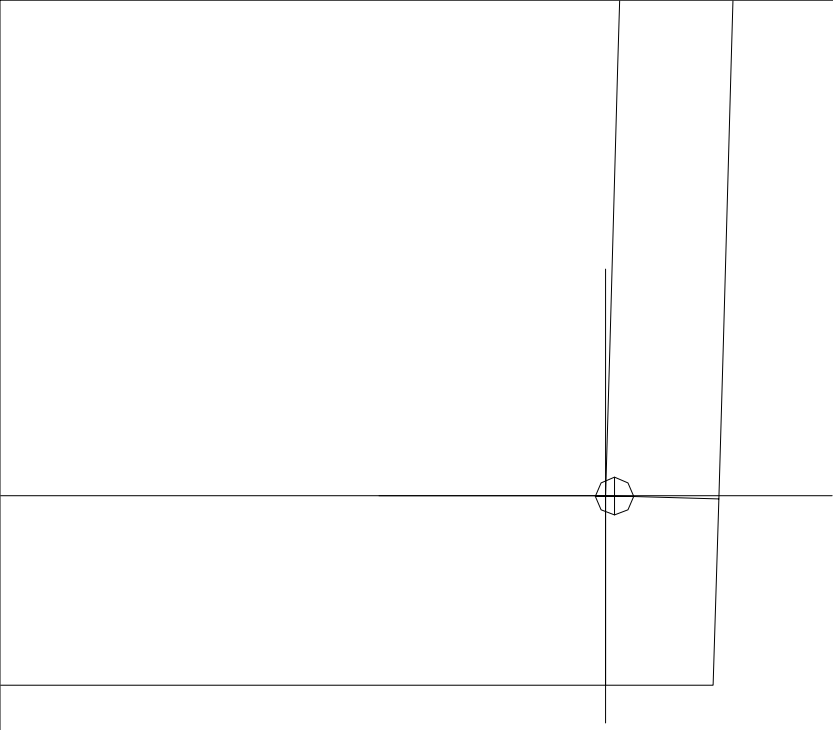

12-7

--	--

$$12 - 8$$

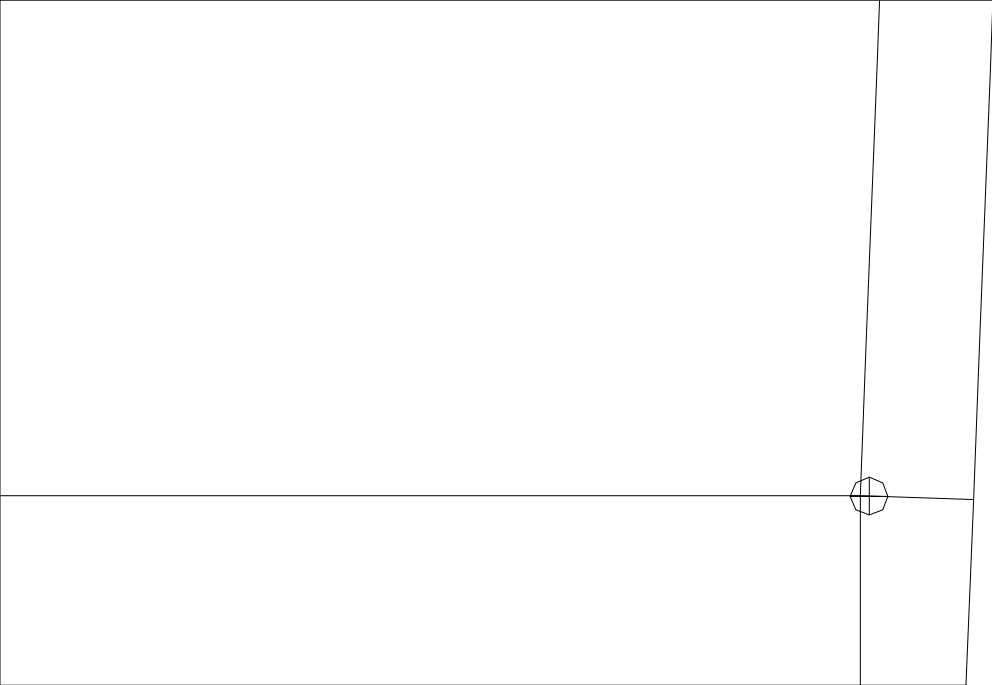

12-9

1-2

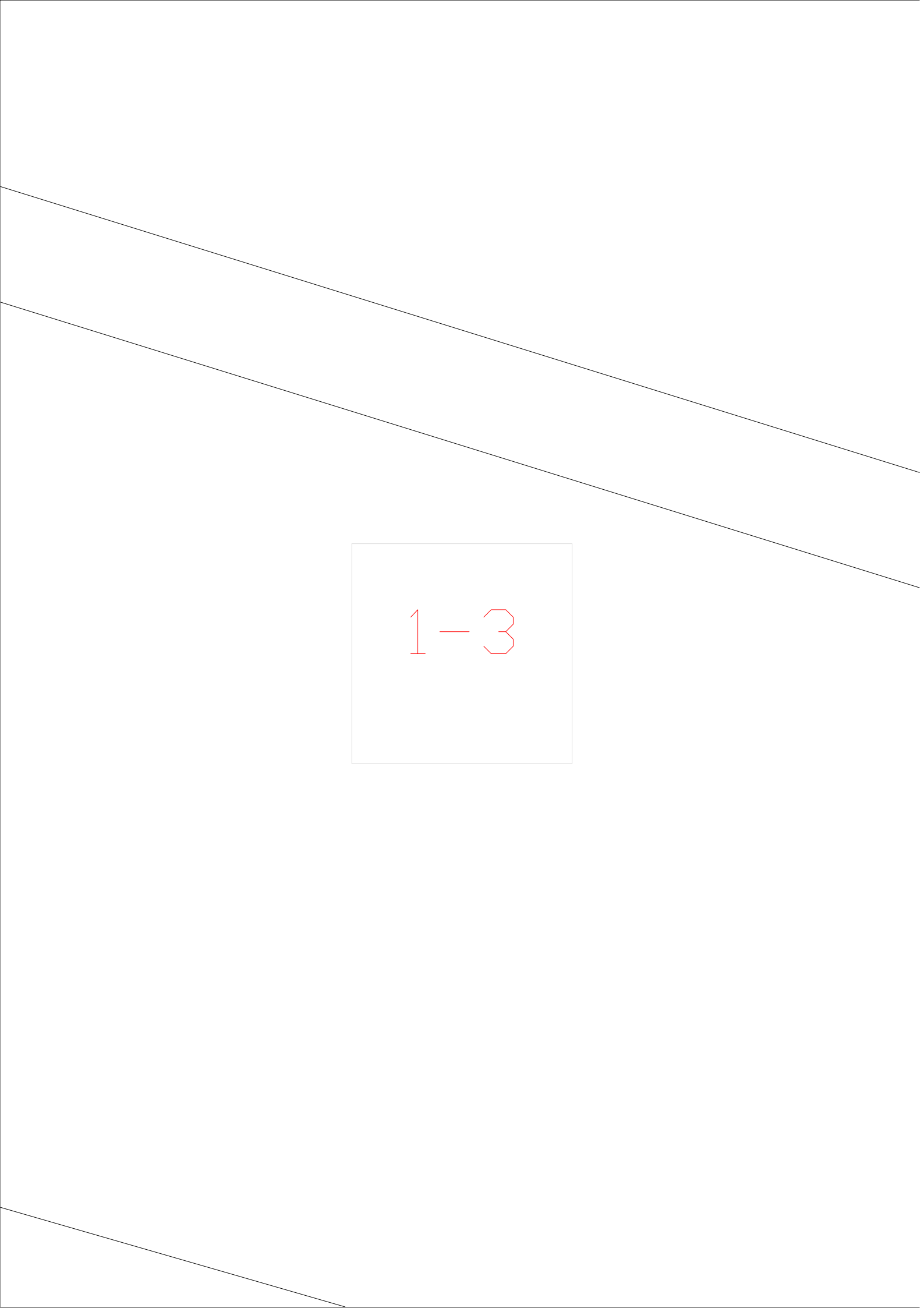

1-3

The image shows a technical drawing of a vertical shaft. The shaft is represented by two parallel lines that are slightly tapered. In the center of the shaft, there is a rectangular box containing the text '1-3' in red. At the top and bottom of the shaft, there are circular cross-section markers, each consisting of a circle with a vertical line through its center. The top of the shaft is connected to a horizontal line, and the bottom is also connected to a horizontal line, suggesting it is part of a larger assembly.

1-4

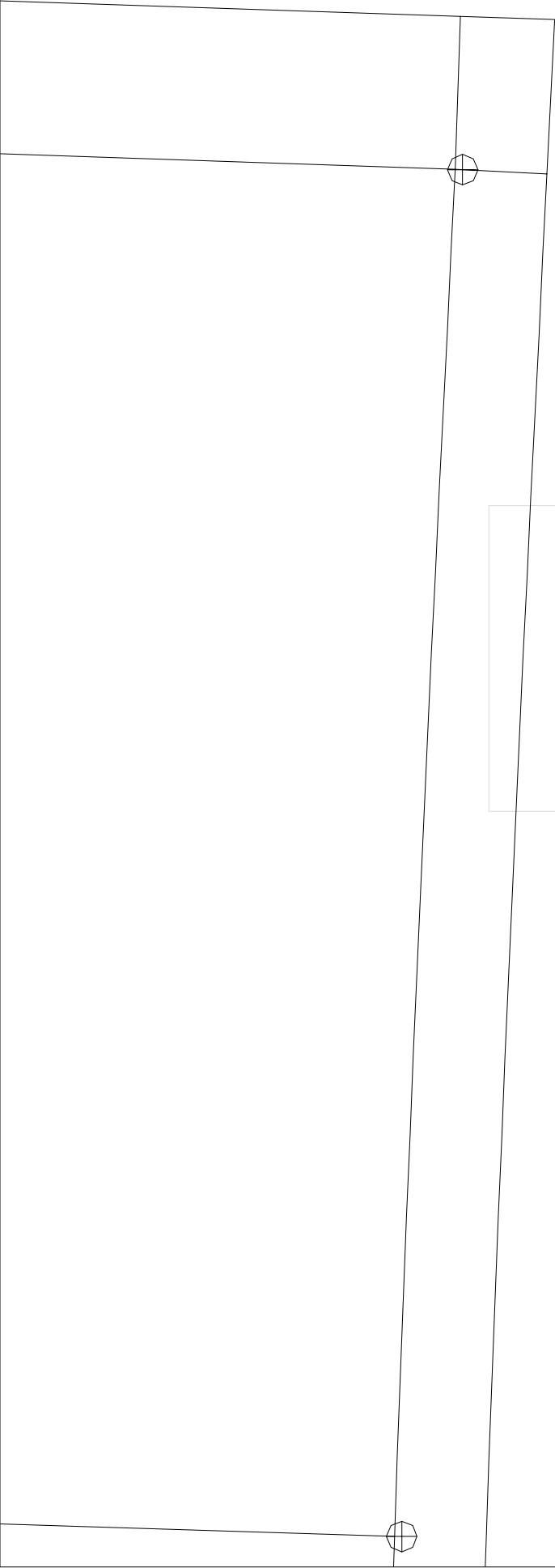

1-5

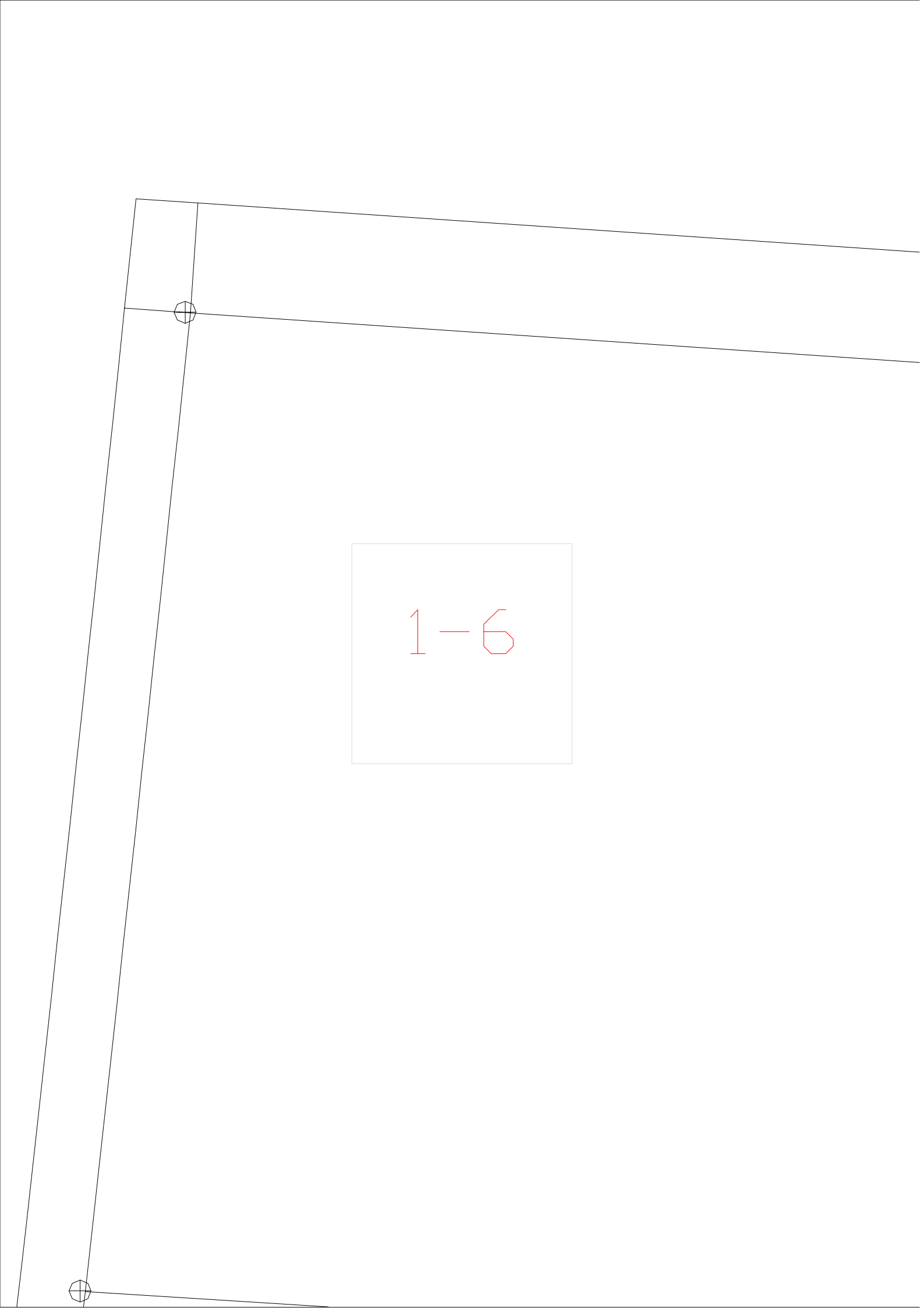

1-6

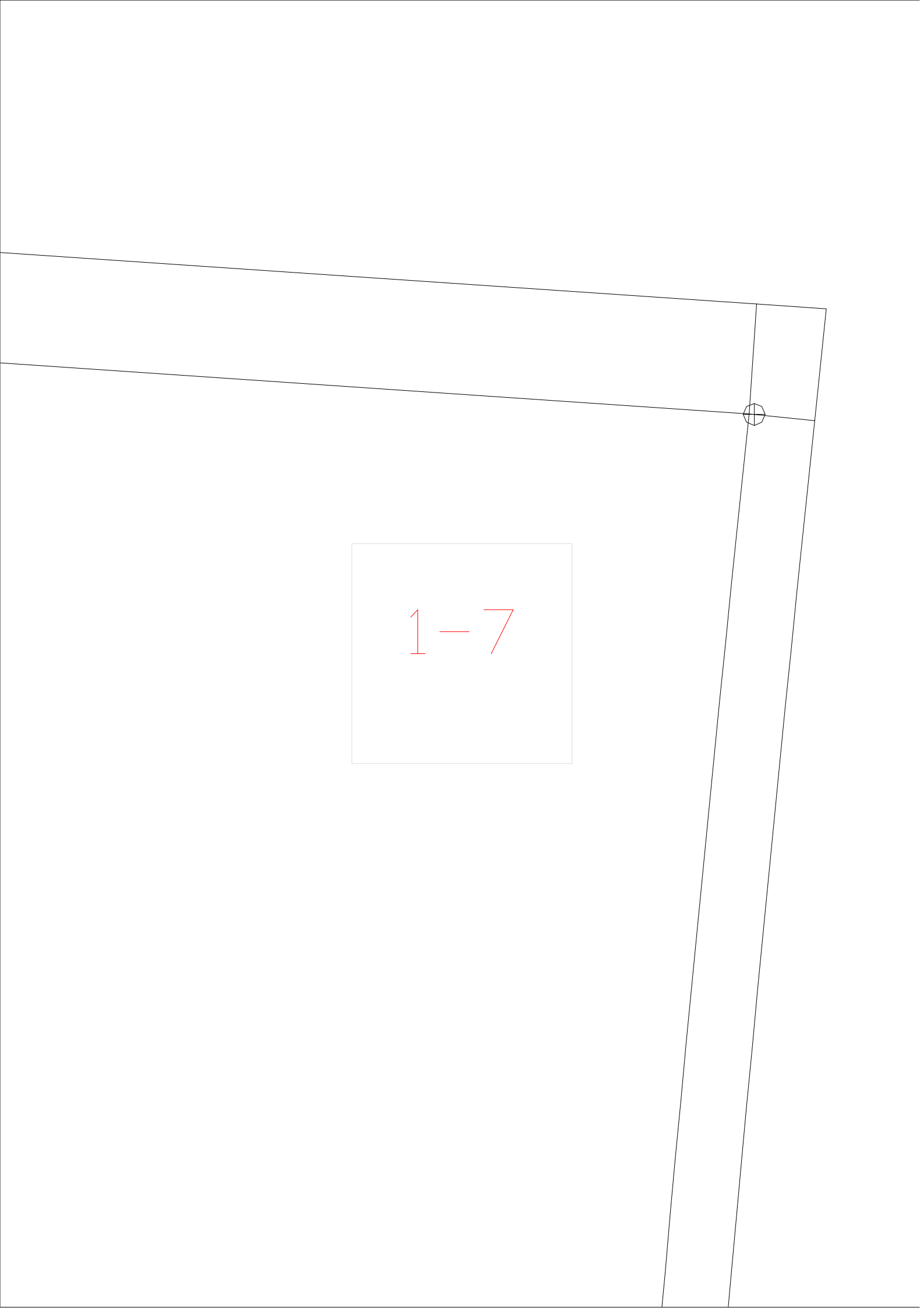

1-7

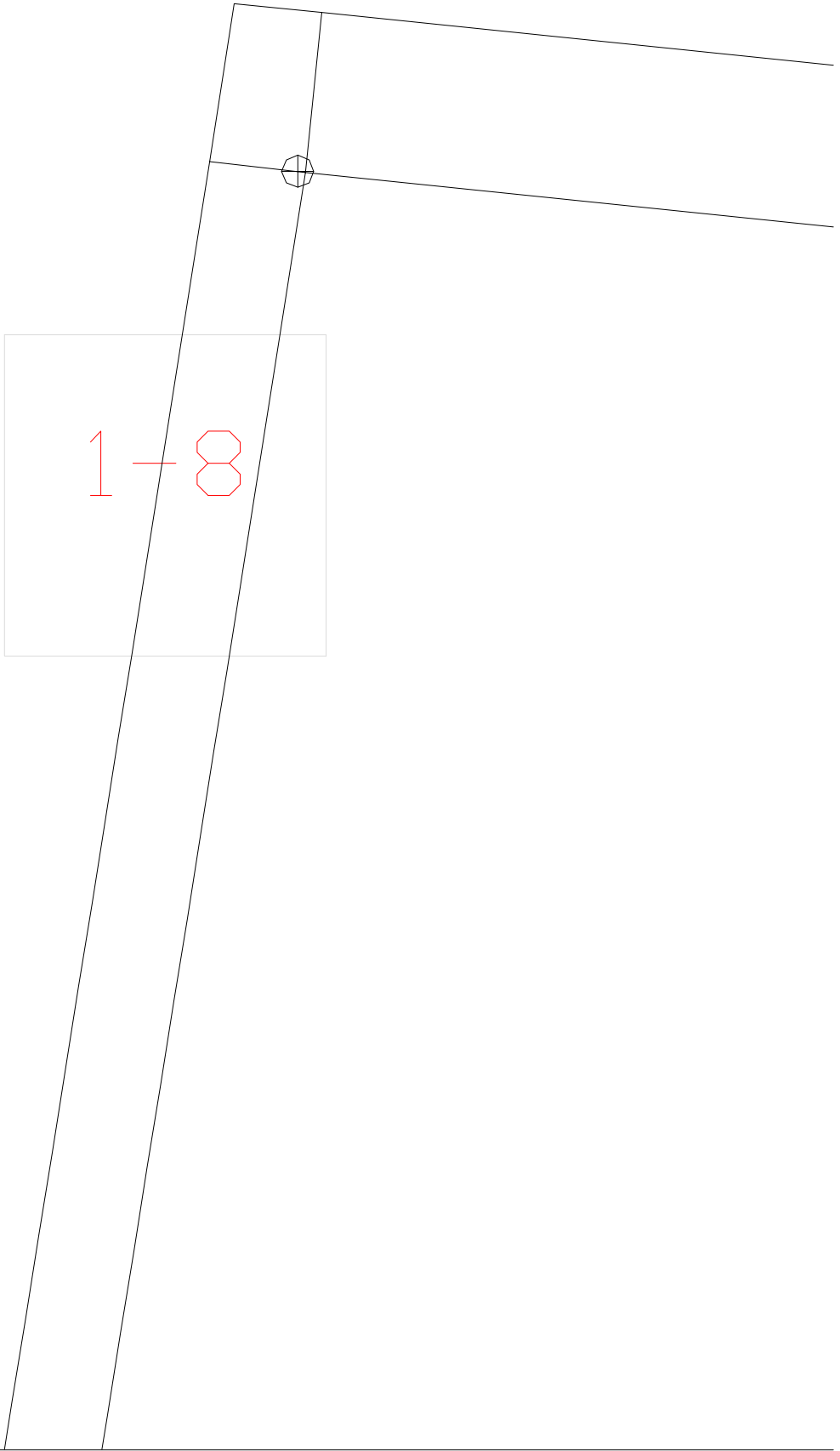

1-8

1-9

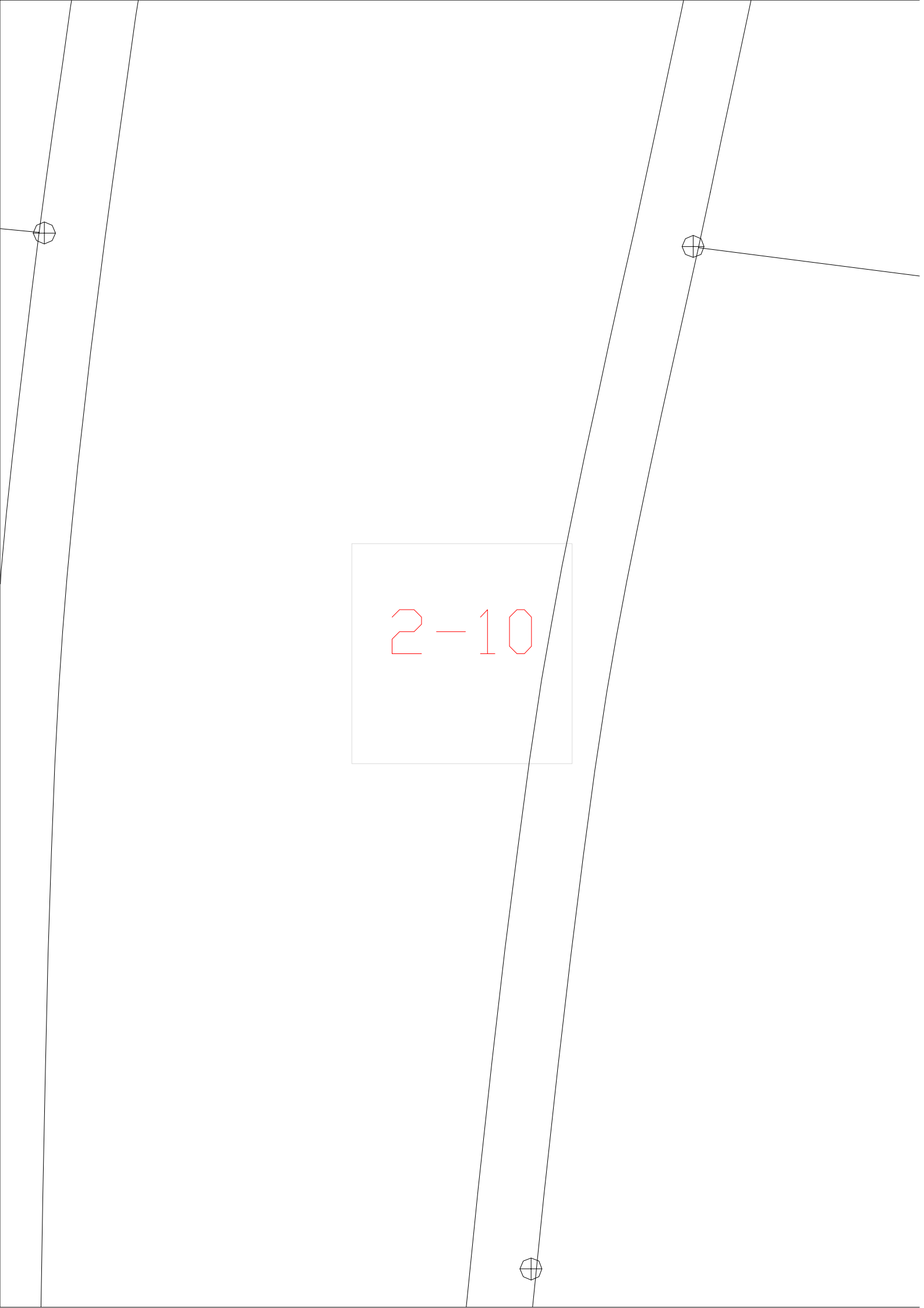

2-10

The image shows a technical drawing of a trapezoidal component. The drawing consists of several lines: a top horizontal edge, a bottom horizontal edge, and two slanted side edges. A central rectangular area is highlighted with a light gray background and contains the red text '2-10'. Three circular features, each with a crosshair, are positioned at the corners of the trapezoid: one at the top-left, one at the top-right, and one at the bottom-center. The drawing is oriented vertically on the page.

2-11

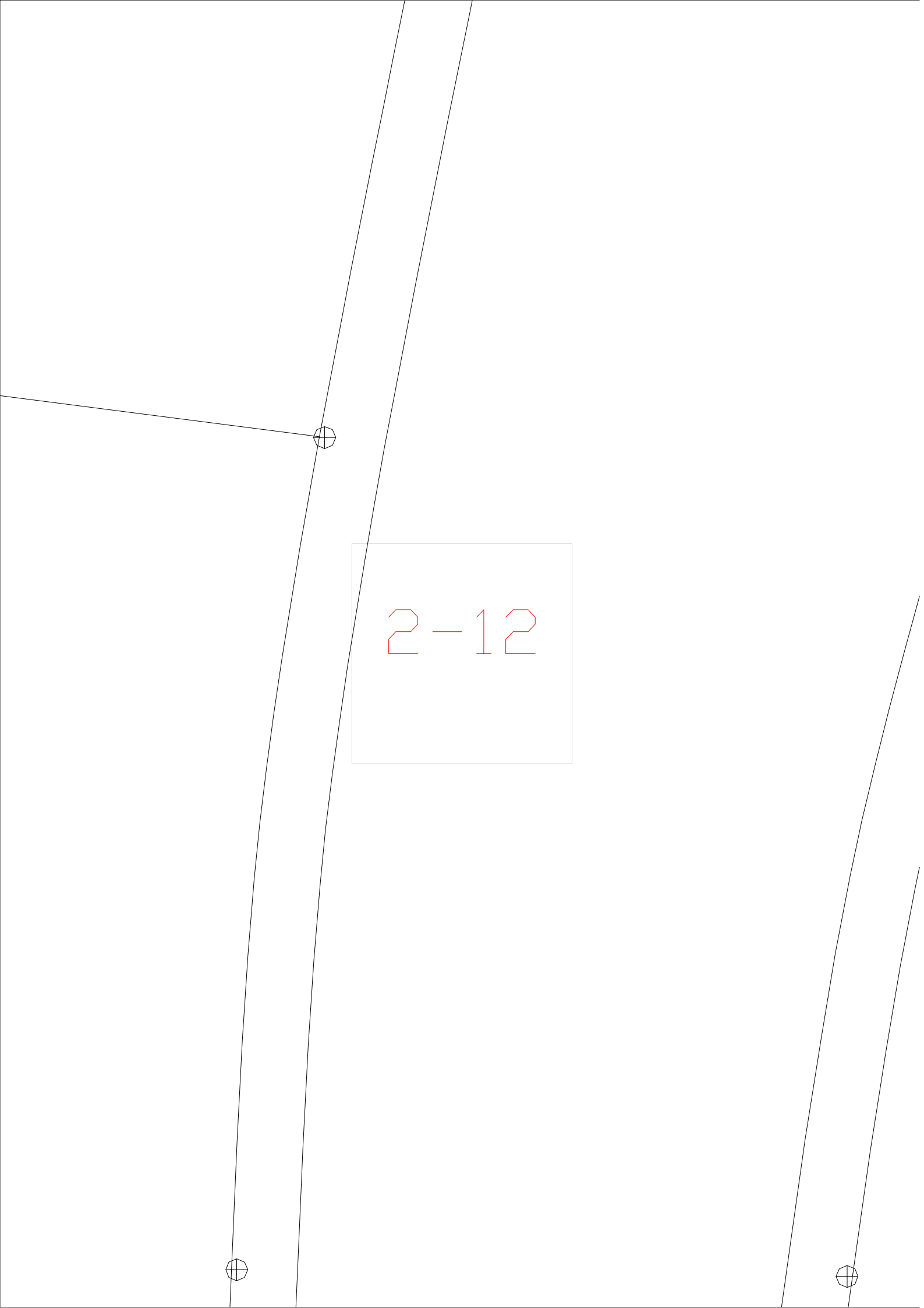

A technical drawing of a shaft with a hole. The shaft is shown in a perspective view, with a hole drilled through its center. The hole is represented by a circle with a cross inside. The shaft is shown with a light gray shaded area to indicate its cylindrical form. A label '2-12' is placed in a light gray box in the center of the shaft. The drawing is on a white background with a light gray grid.

2-12



2-13

2-14

The image shows a technical drawing of a curved surface, possibly a part of a cylinder or a similar object. A light gray shaded region highlights a portion of the surface. Within this shaded area, a rectangular box is drawn, containing the text '2-14' in red. A thin black line extends from the left edge of the drawing, passing through the right side of the rectangular box and ending at a small circular symbol with a cross inside. Another similar circular symbol is located at the bottom center of the drawing, where the curved surface meets the bottom edge. The drawing is composed of several thin black lines representing the geometry of the object.

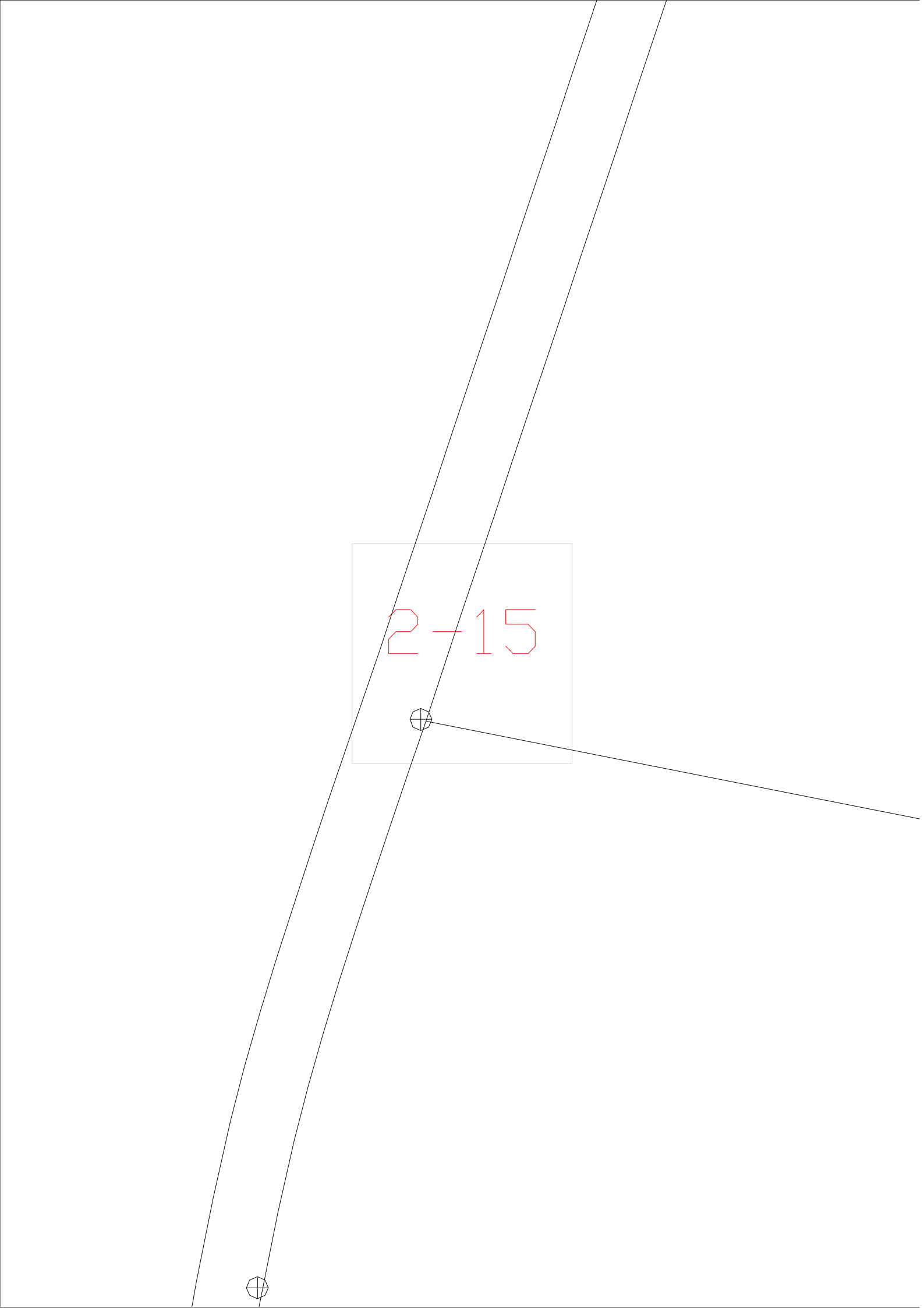

A technical drawing showing a curved surface, possibly a part of a cylinder or sphere, defined by two lines that curve away from each other. A light gray rectangular box highlights a specific region on the surface. Inside this box, the text "2-15" is written in red. Two circular symbols, each with a crosshair, are positioned on the surface: one at the bottom left and another at the center of the highlighted area. A thin line extends from the right side of the highlighted area towards the right edge of the drawing.

2-15

2-16



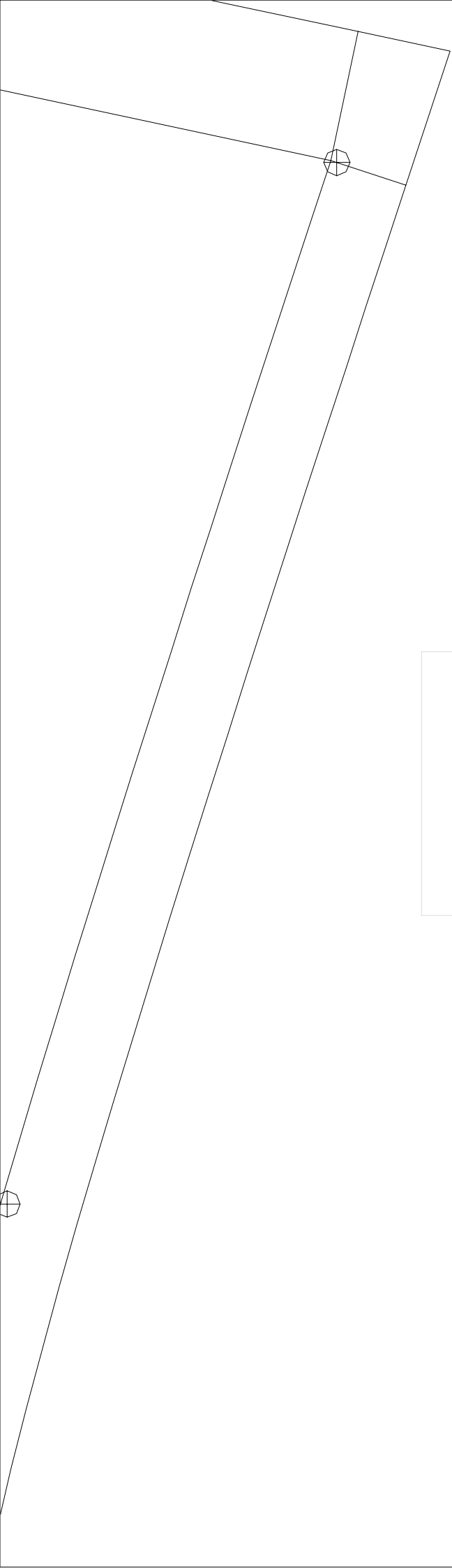

2-17

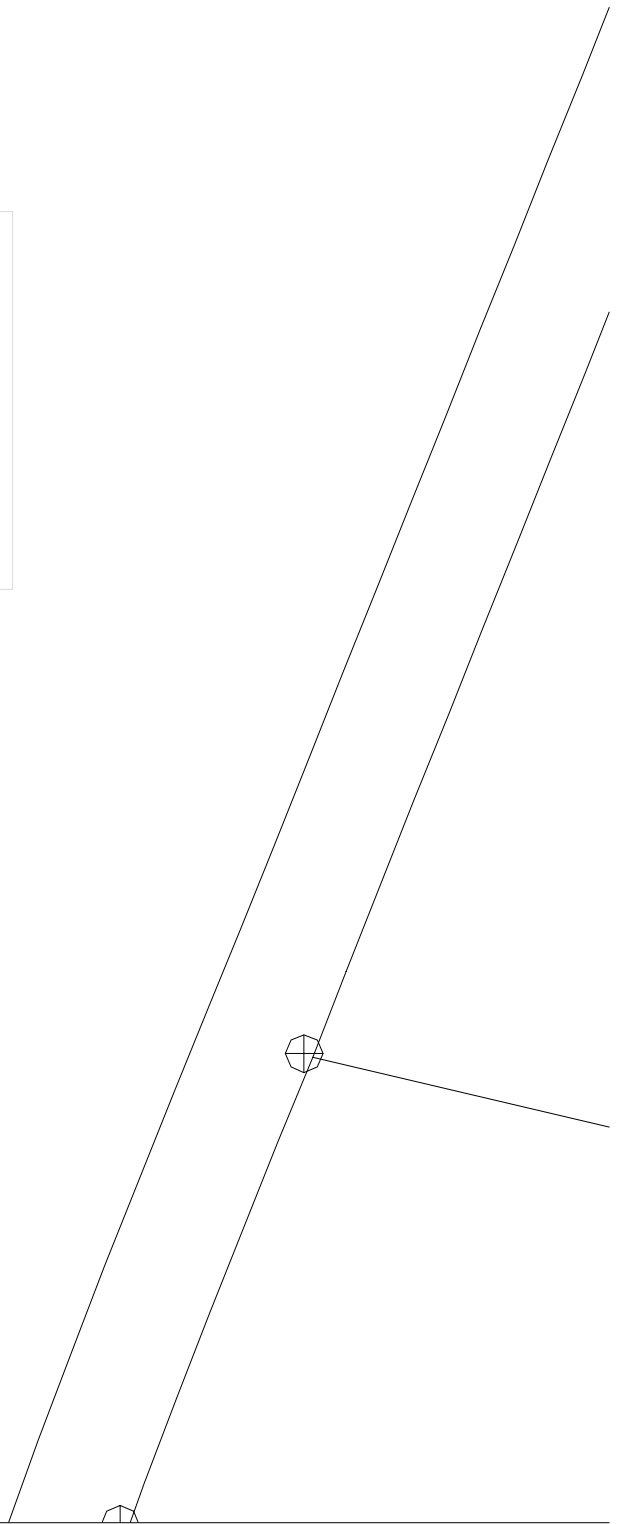

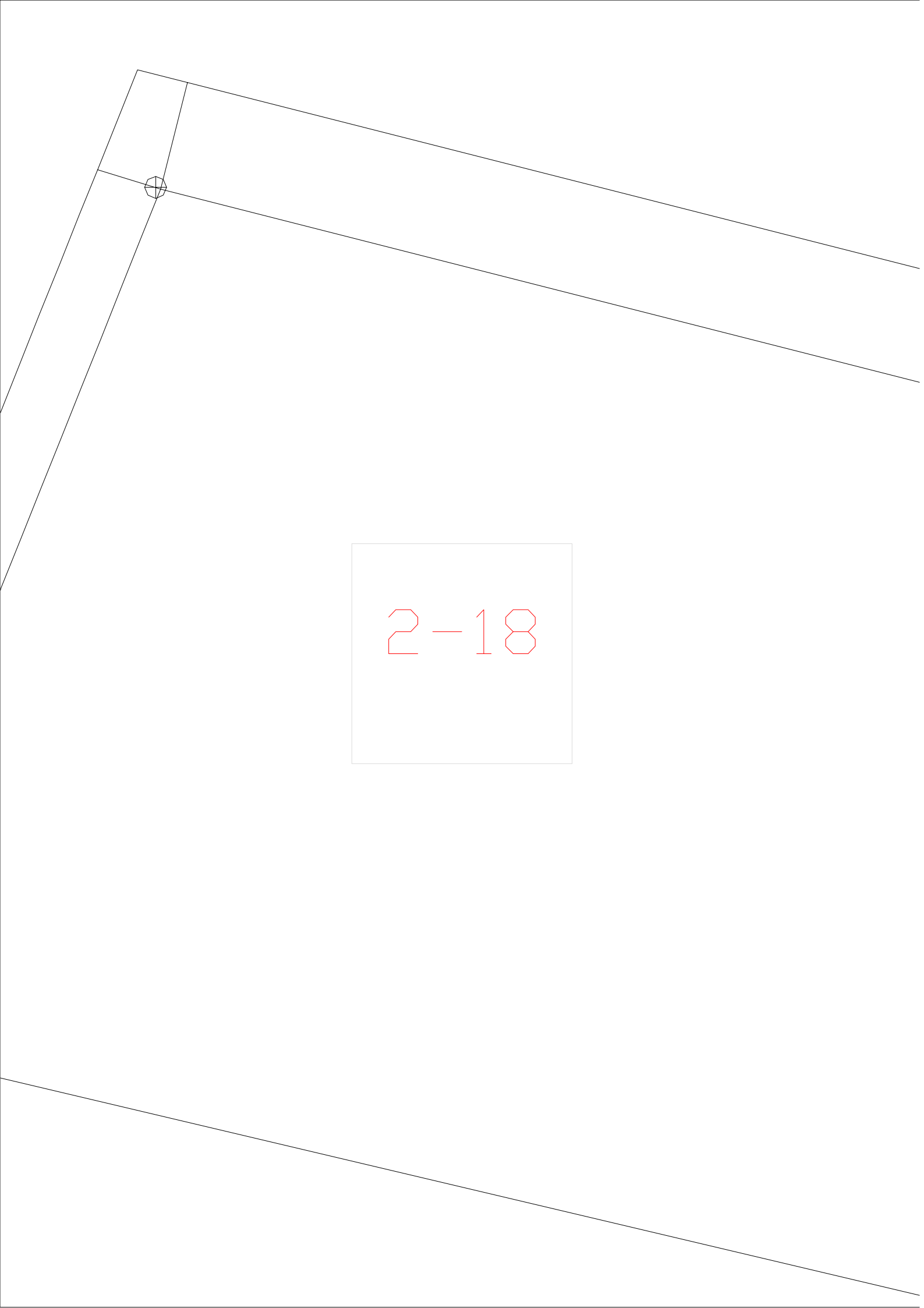

2-18

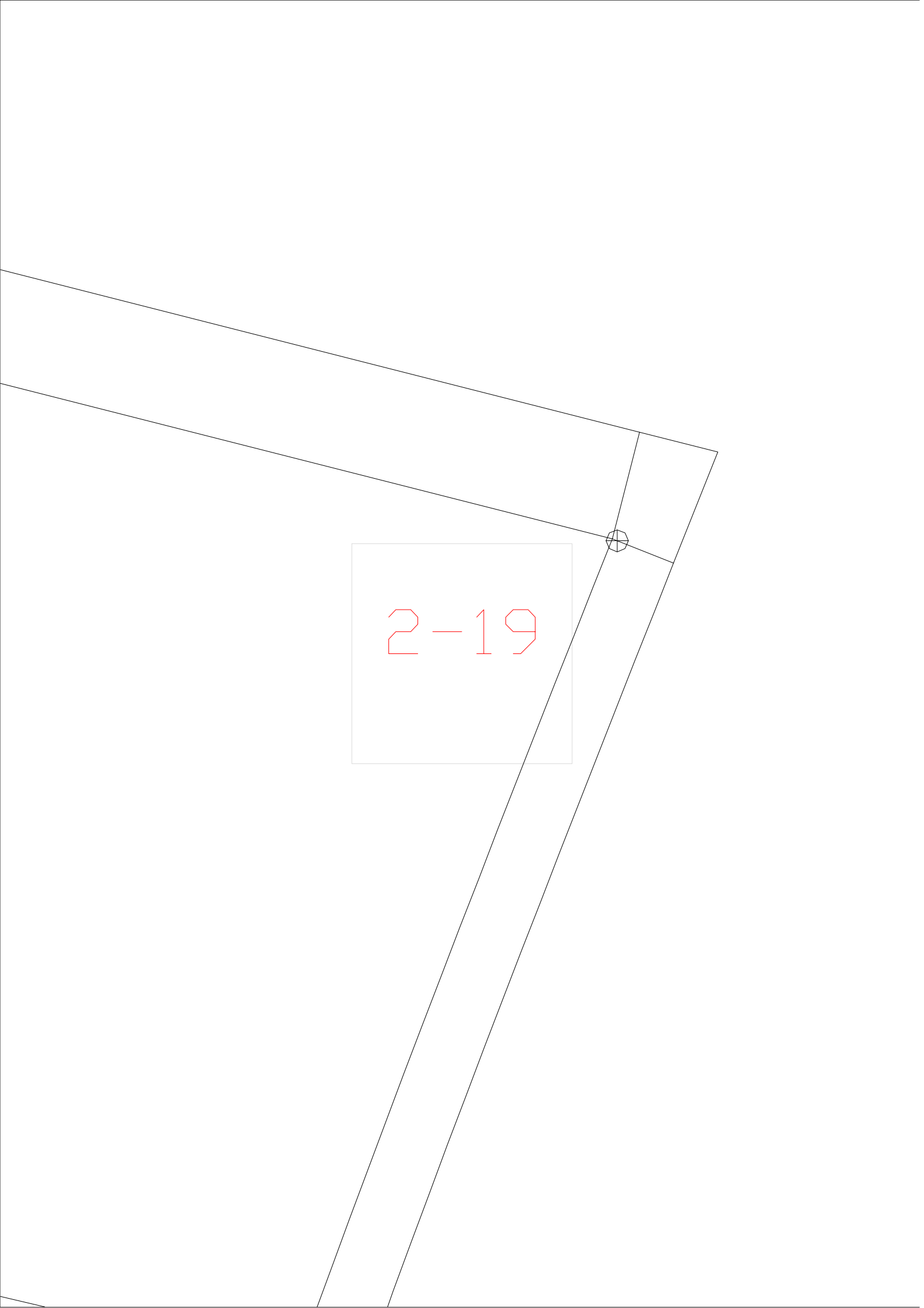

2-19



2-1





2-2



2-3

The image shows a technical drawing of a vertical shaft. The shaft is represented by two parallel lines that are slightly curved, indicating a cylindrical shape. A central hole is shown as a thin vertical line passing through the shaft. A rectangular feature is drawn on the shaft, with the number '2-3' written inside it in red. There are four small circles, each with a cross inside, located at the top and bottom of the shaft on both sides, likely representing mounting points or fasteners.

2-4



2-5





2-6

2-7



2-8

2-9



3-10



3-11

3-12



3-13

3-14



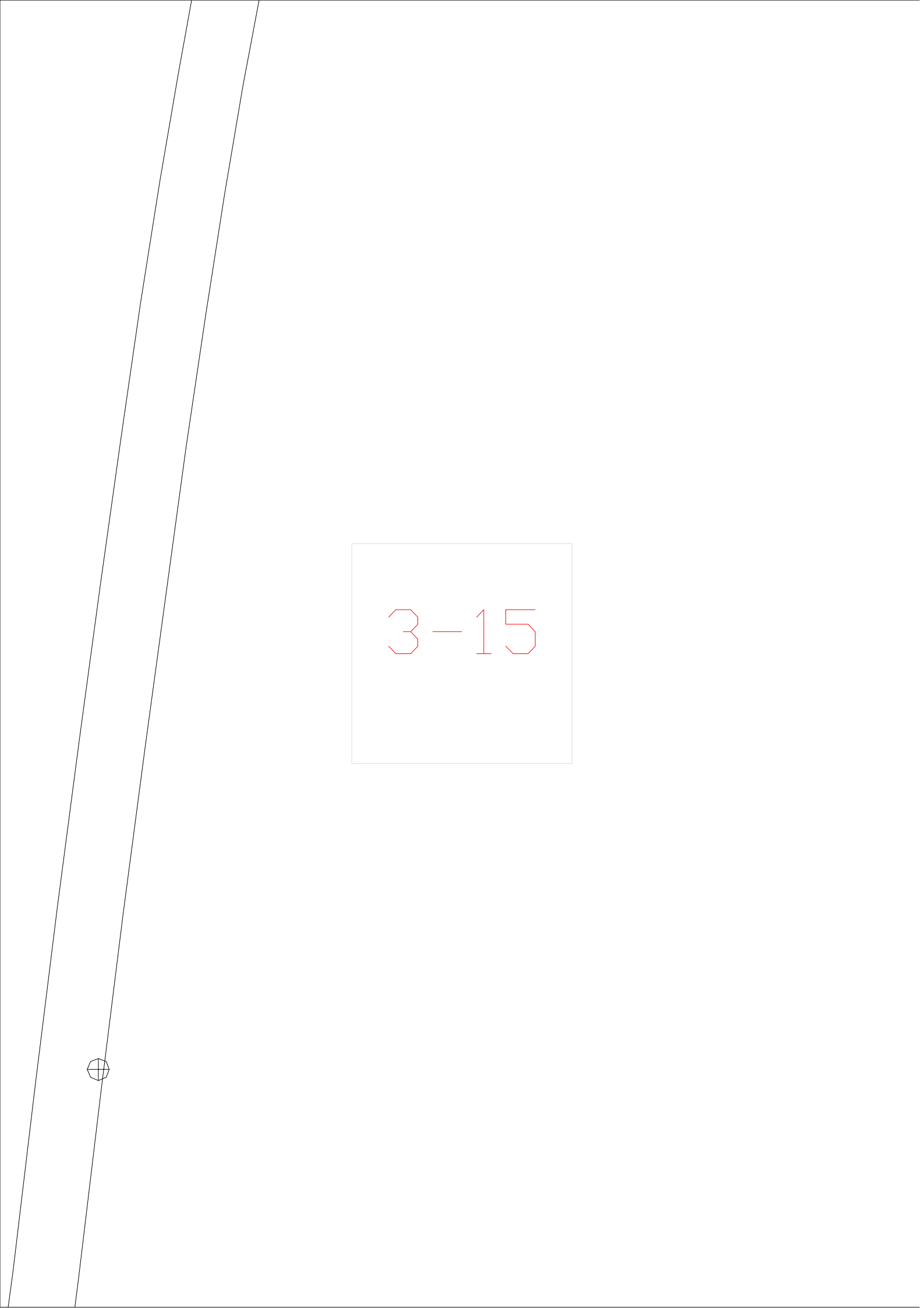

3-15

The image shows a technical drawing of a tapered shaft on the left side, with a circular hole. To the right of the shaft is a rectangular box containing the text '3-15' in red. The rest of the page is blank white.

3-16



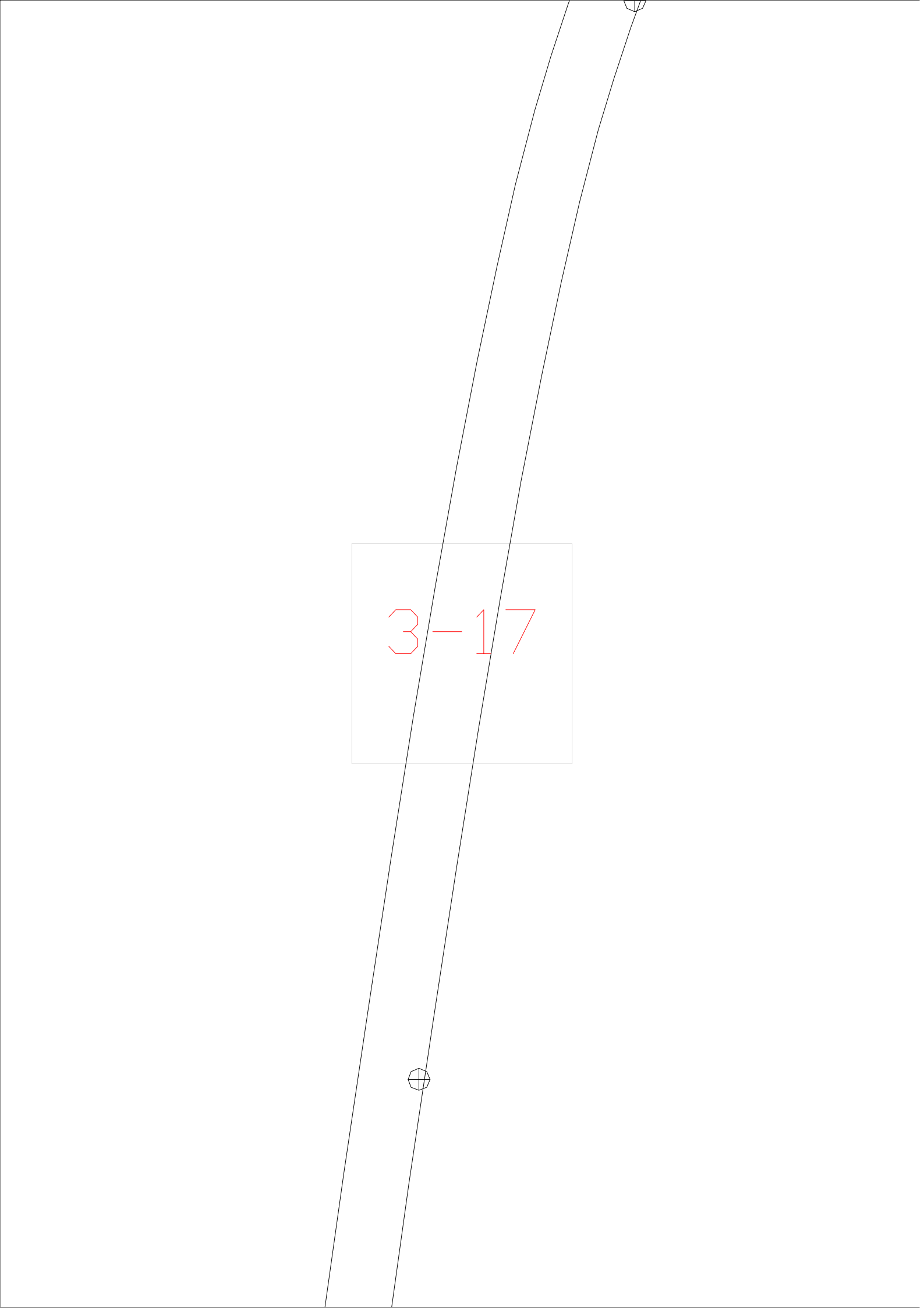

3-17

3-18

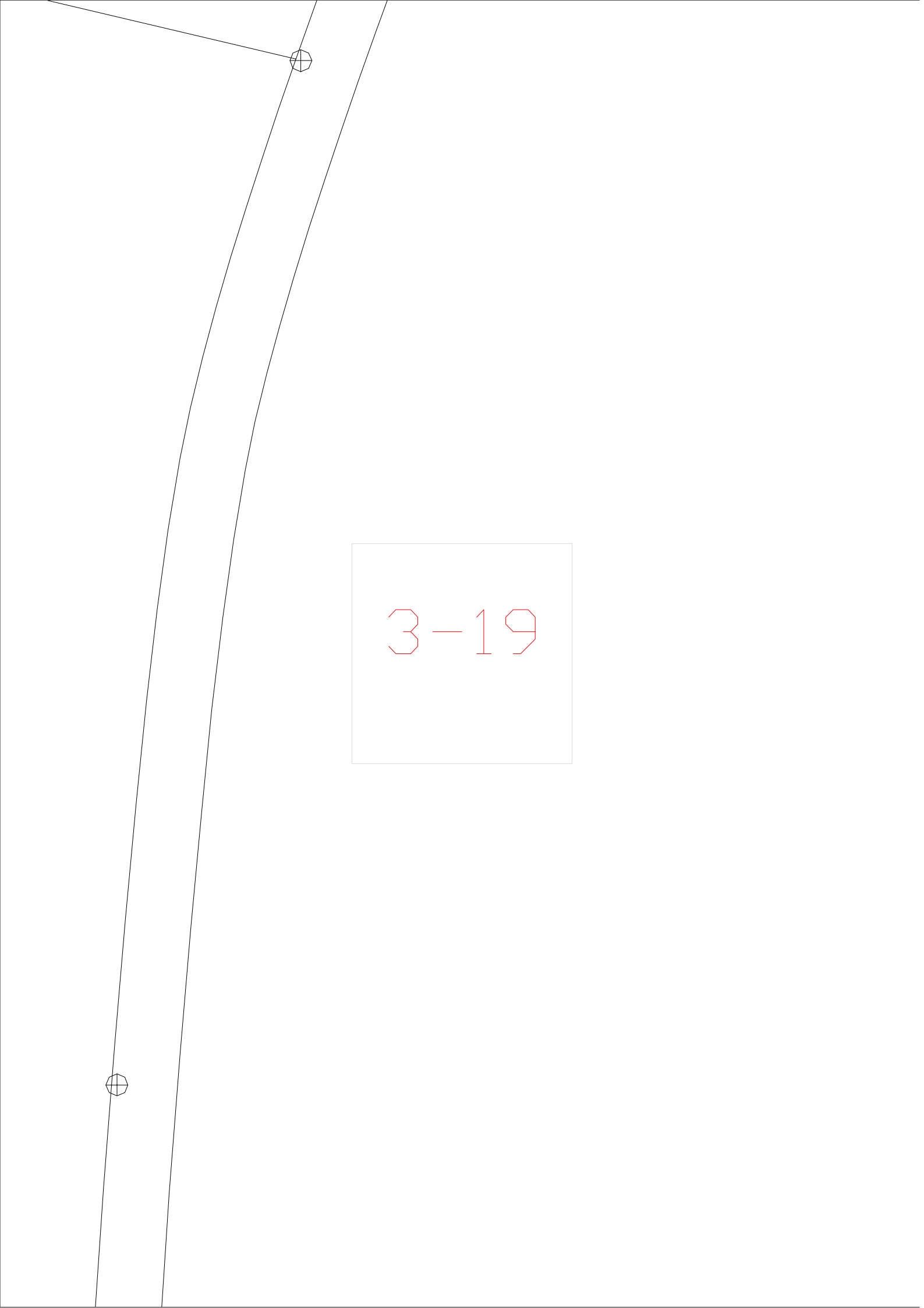

3-19

The image shows a technical drawing on the left side of a white page. It consists of a curved line that starts near the top left and curves downwards and to the right. Two circular markers, each with a cross inside, are placed on the line: one near the top and one near the bottom. To the right of the curve, there is a light blue rectangular box containing the red text '3-19'.

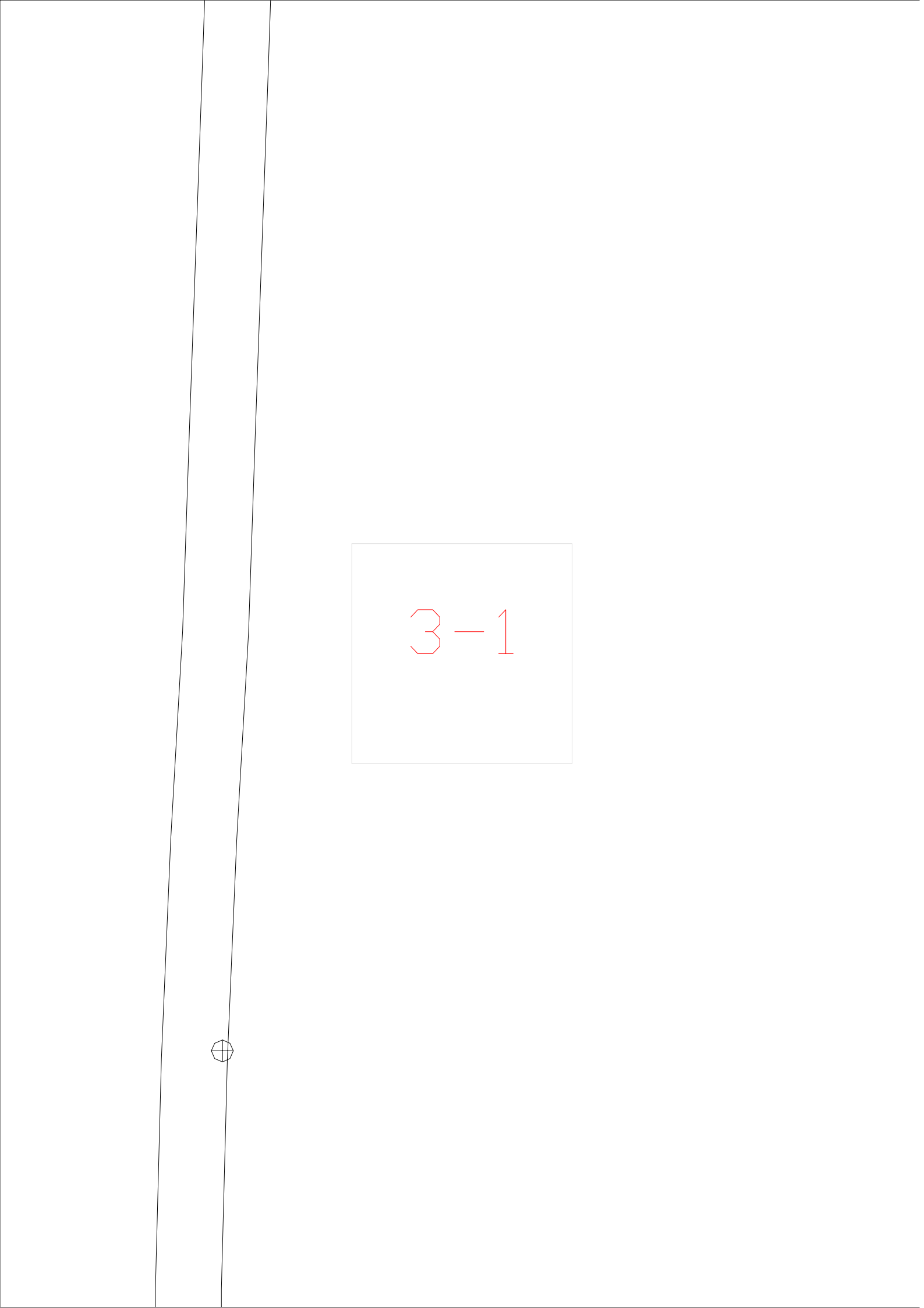

3-1

3-2

3-3



3-4

3-5



3-6

3-7



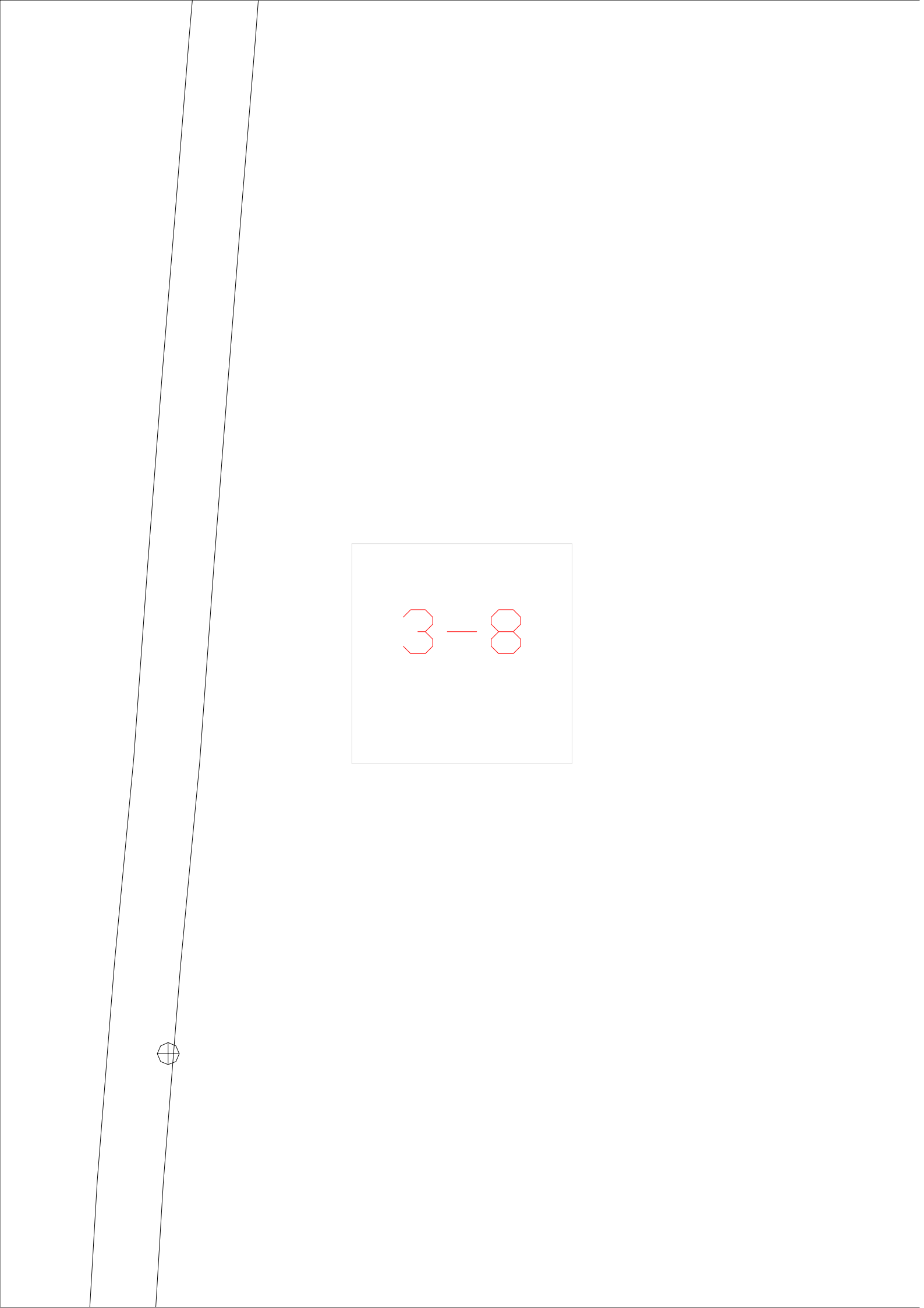

3-8

3-9



4-10



4 - 11

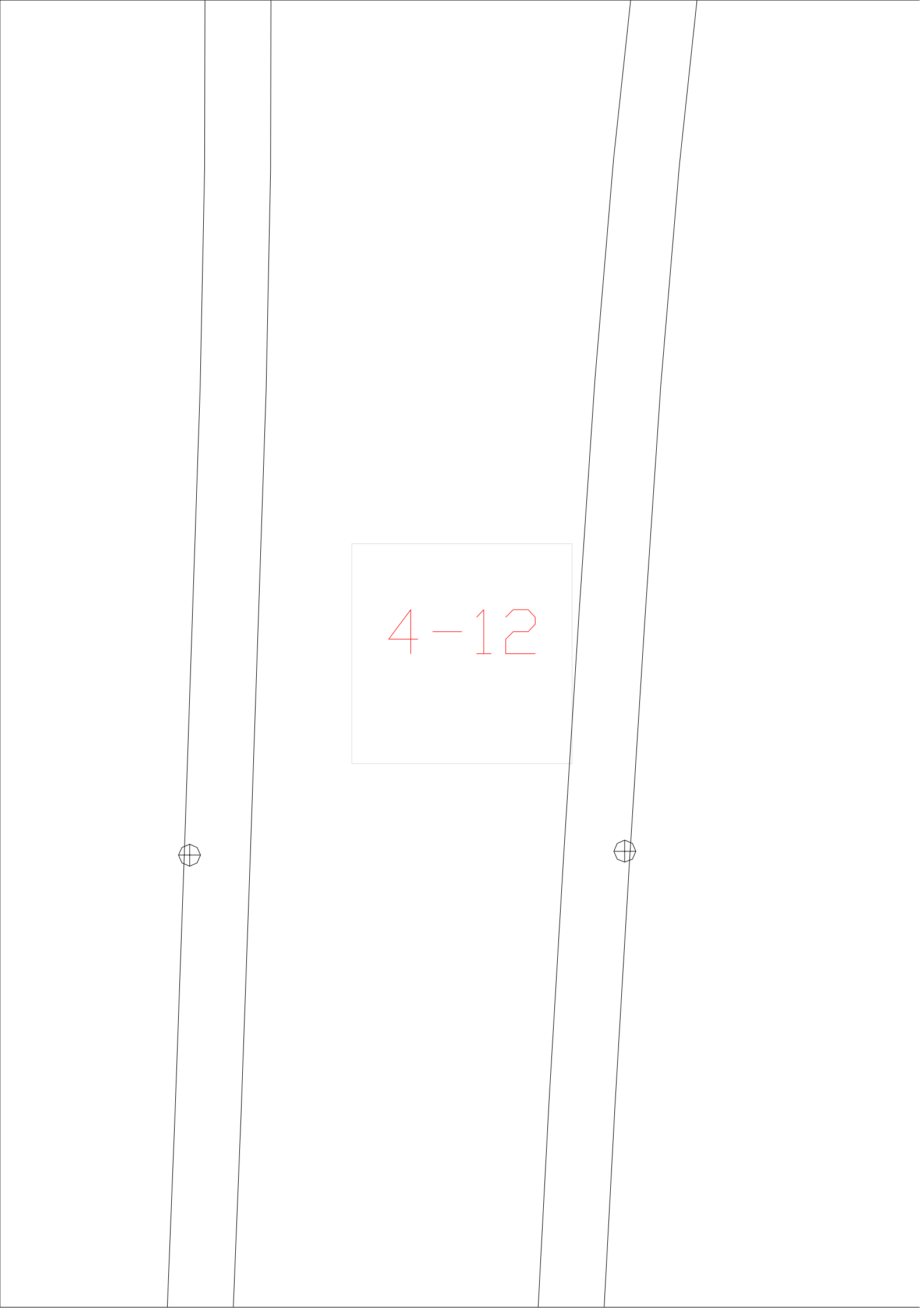

4-12

4-13

4-14



4-15

4-16



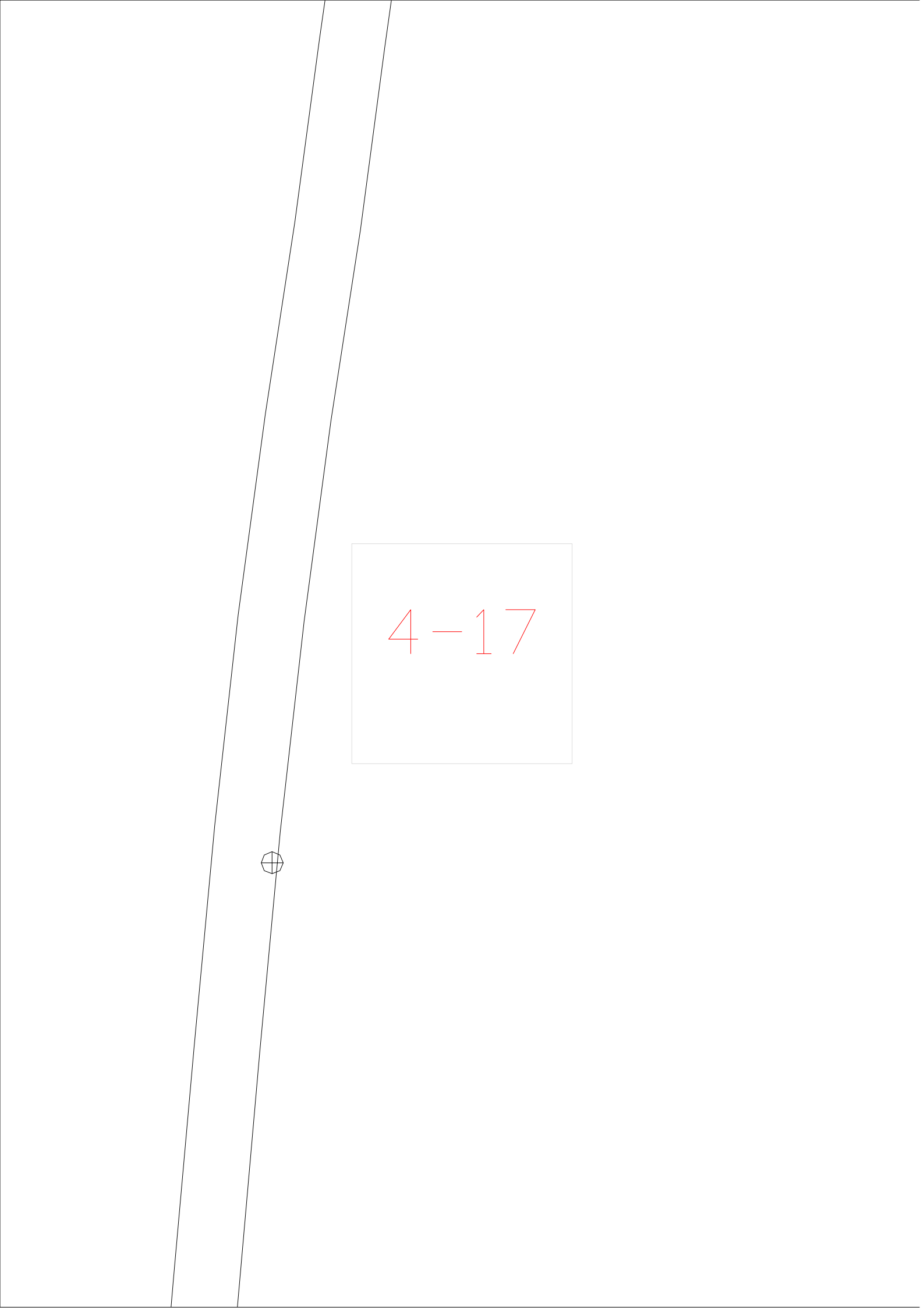

4-17

4-18



4-19

$$4 - 1$$



$$4 - 2$$

4-3



$$4 - 4$$

4-5



4-6

$$4 - 7$$



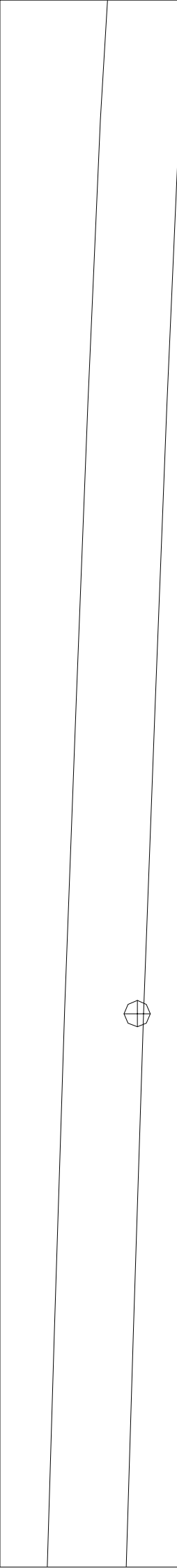

4 - 8

4-9





5-10

5-11

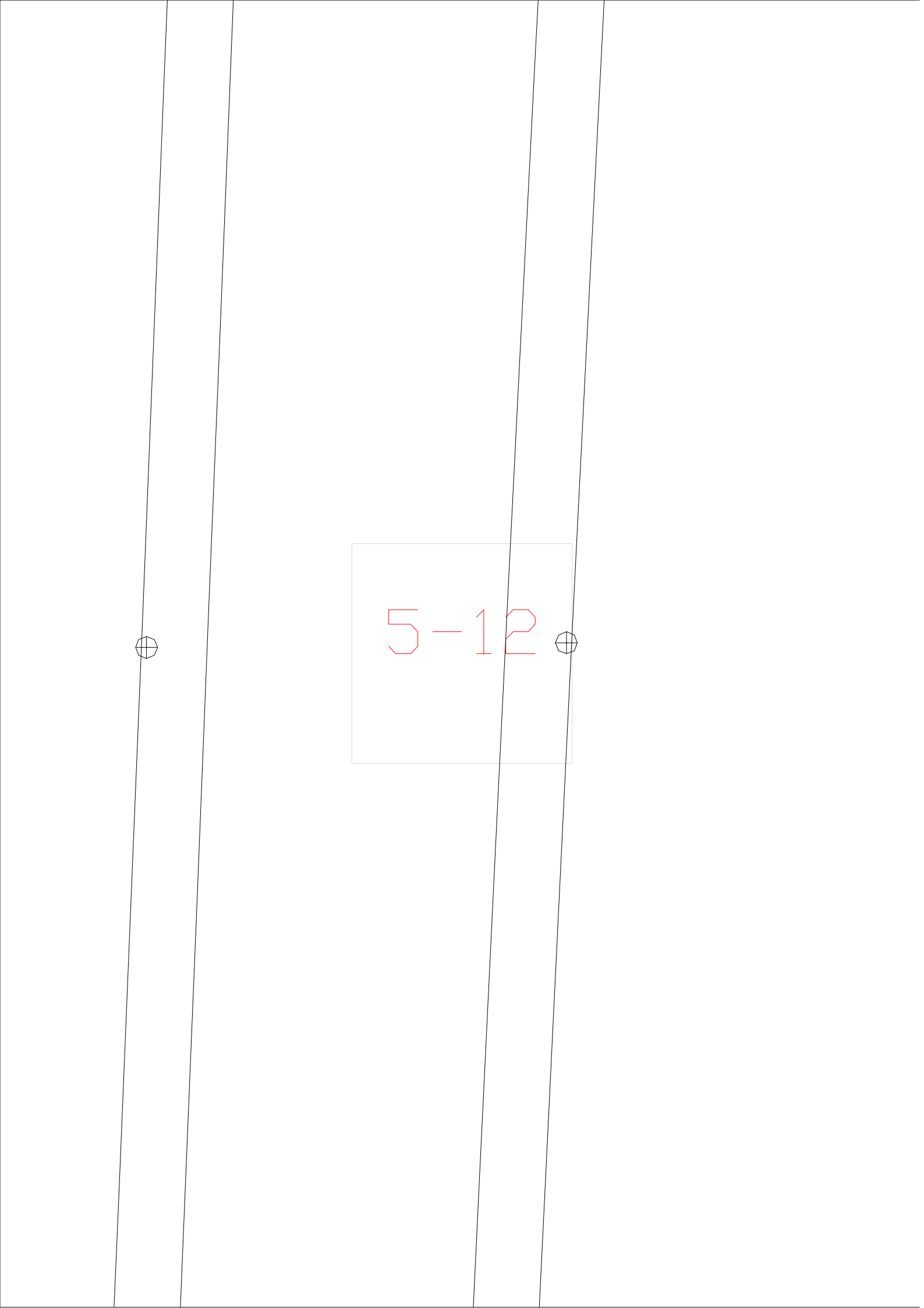

5-12

The image shows a technical drawing of a vertical shaft. The shaft is represented by two parallel lines that are slightly tapered. There are two circular features on the shaft, one on the left and one on the right, each with a crosshair symbol. A central rectangular box contains the text '5-12' in red.

5-13

5-14



5-15

5-16





5-17

5-18



5-19



5-1

5-2



5-3

5-4



5-5



5-6

5-7





5-8

5-9





6-10

6-11



6-12

6-13



6-14

6-15

6-16





6-17

6-18



6-19



6-1

6-2



6-3



6-5

6-6



6-7



6-8

6-9





7-10

7-11

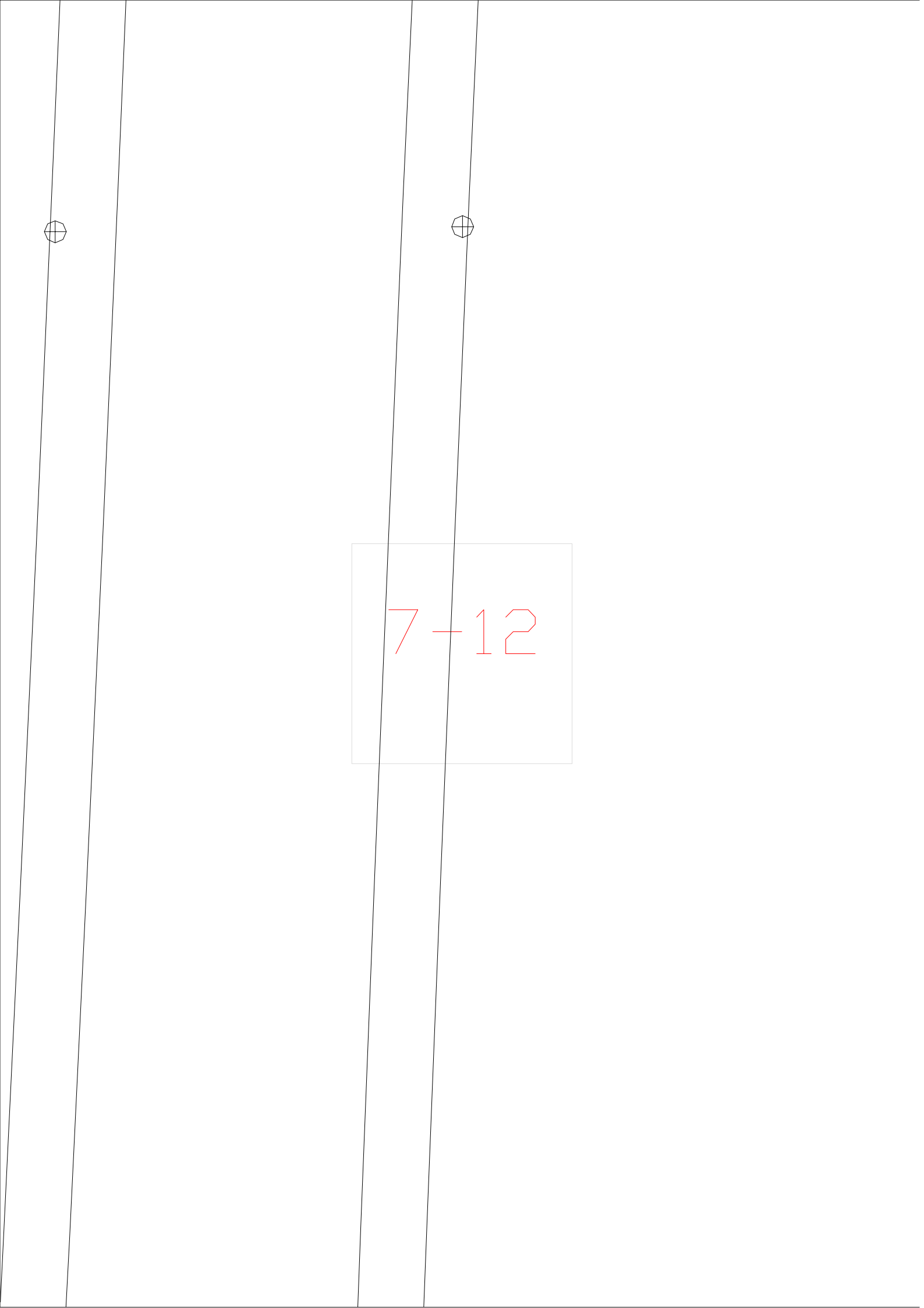

7-12

7-13



7-14

7-15



7-16



7-17

7-18



7-19



$$7 - 1$$

7-2



$$7 - 3$$



$$7 - 5$$

7-6



7-7



7-8



7-9

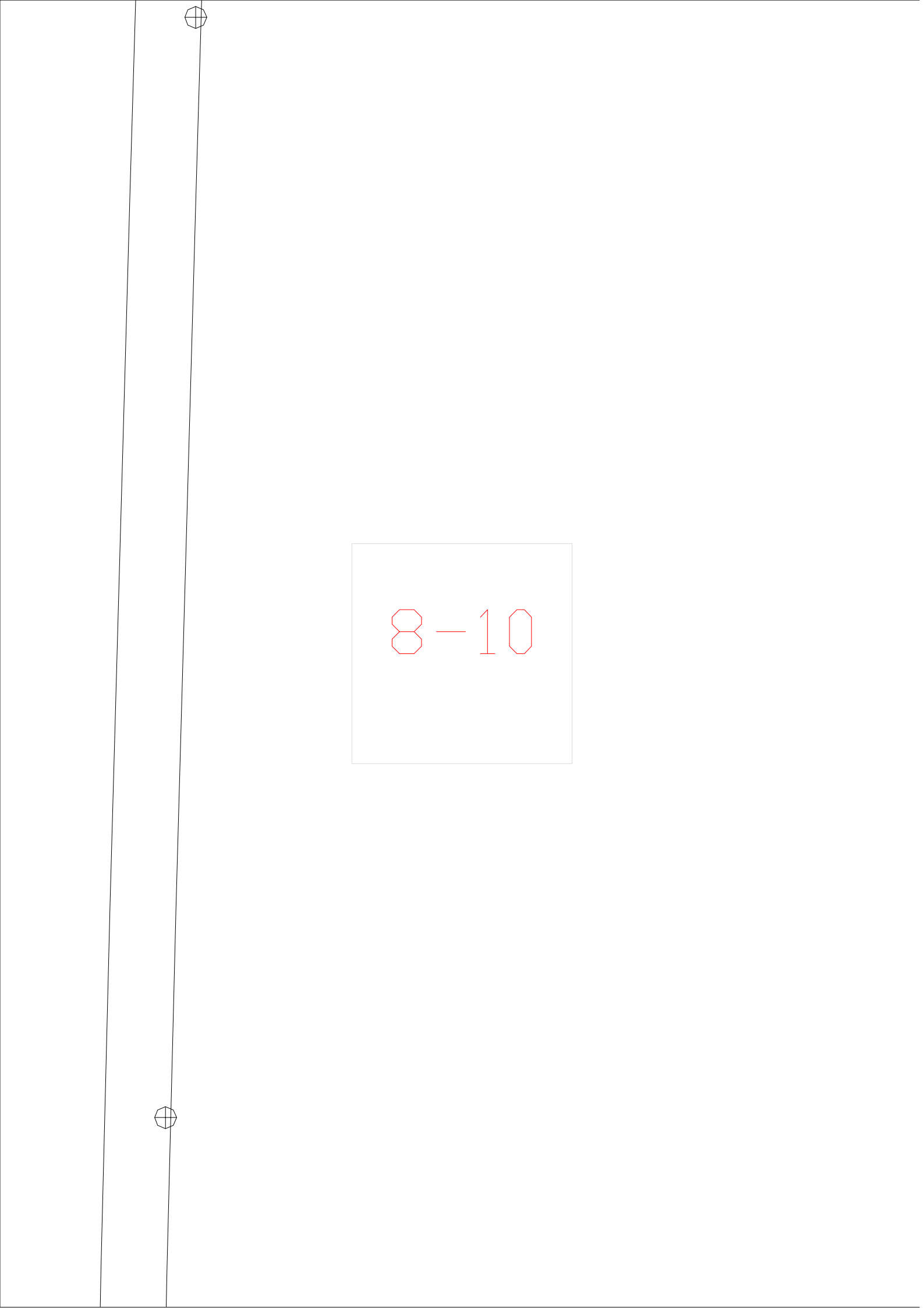

8-10

8-11



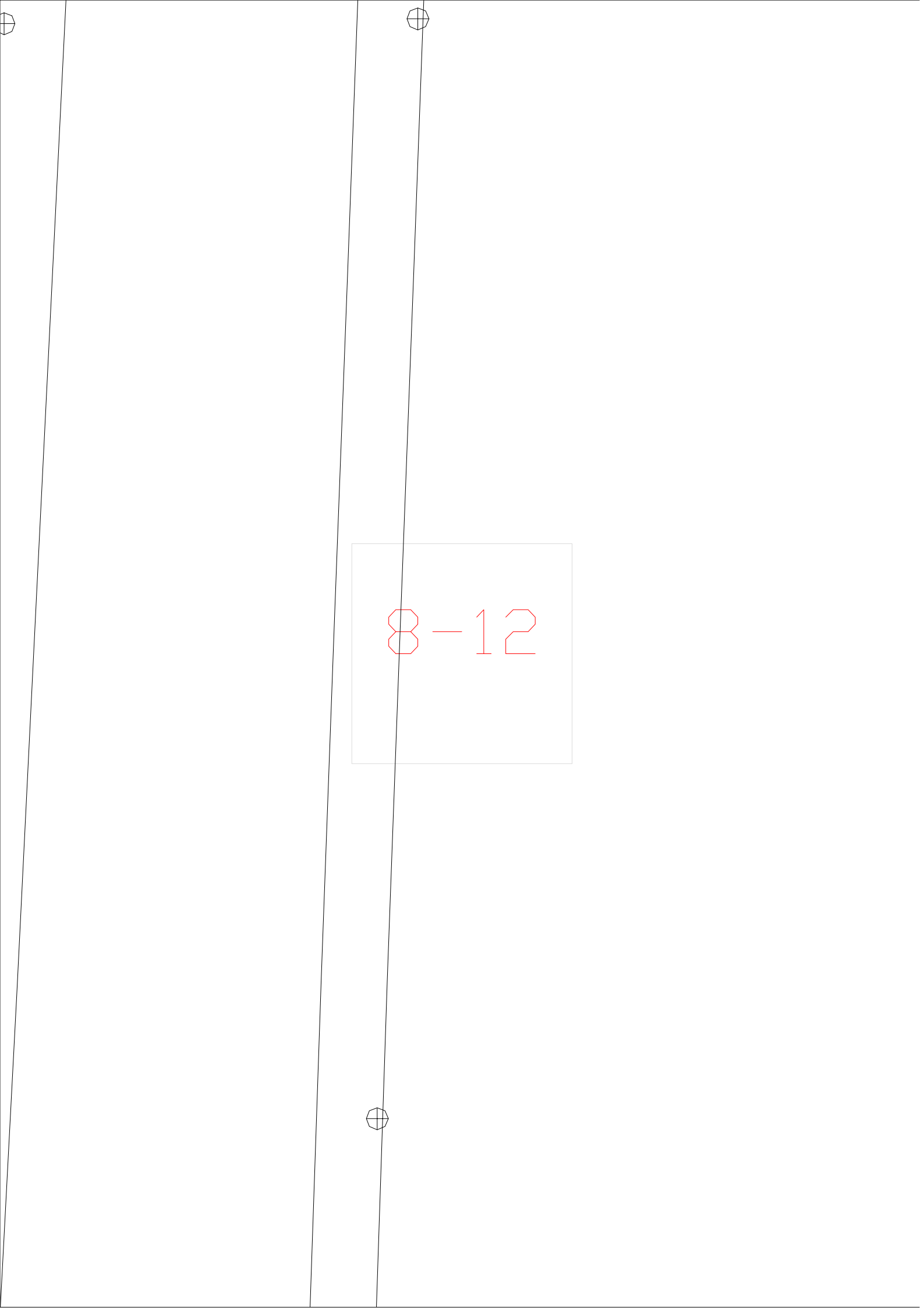

8-12

8-13

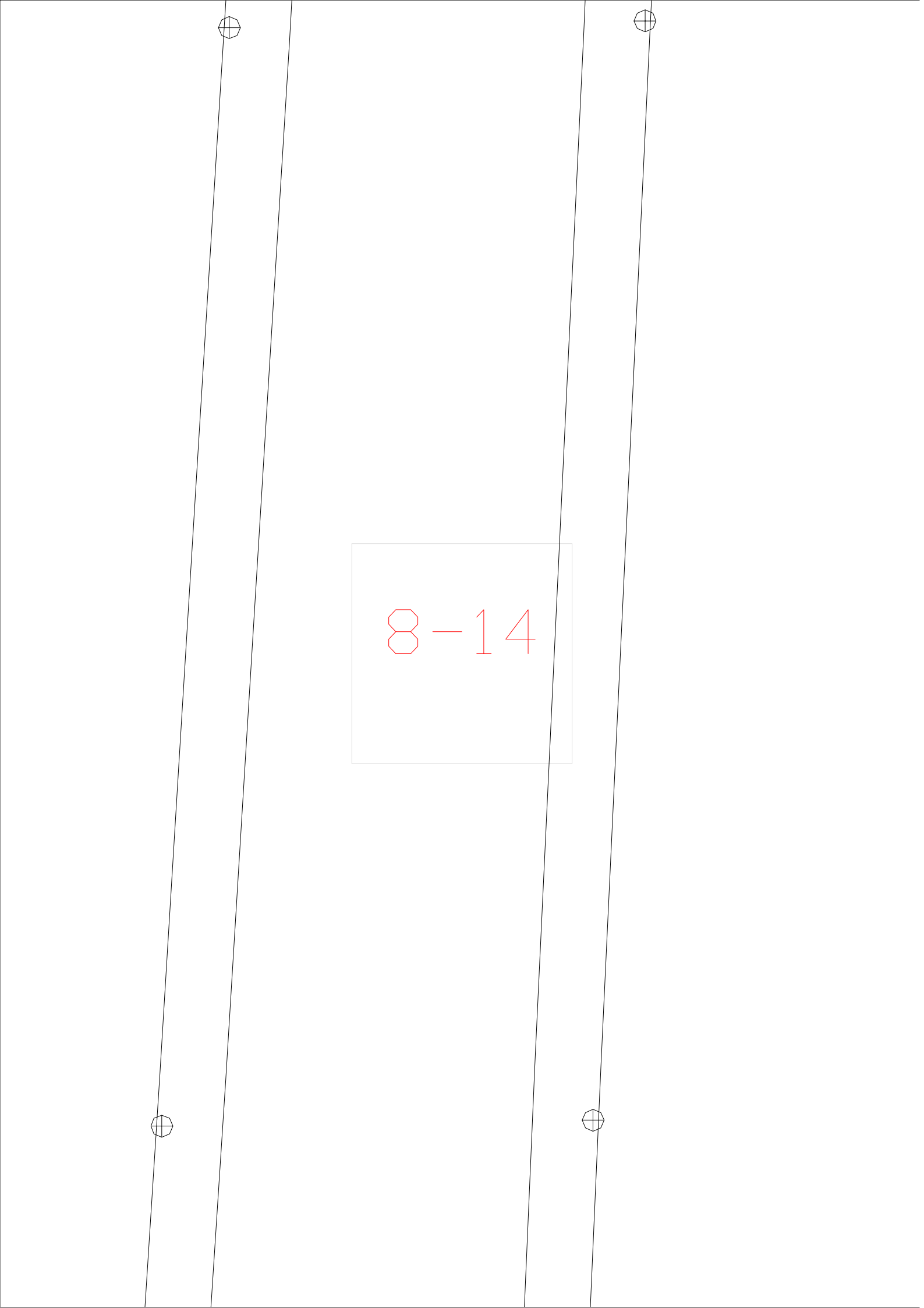

8-14

The image shows a technical drawing of a tapered shaft. The shaft is represented by two parallel lines that converge towards the top, indicating a taper. There are four circular features, likely representing holes or mounting points, located at the top and bottom of the shaft. A central rectangular box contains the text '8-14' in red, which likely refers to a specific part number or specification.

8-15

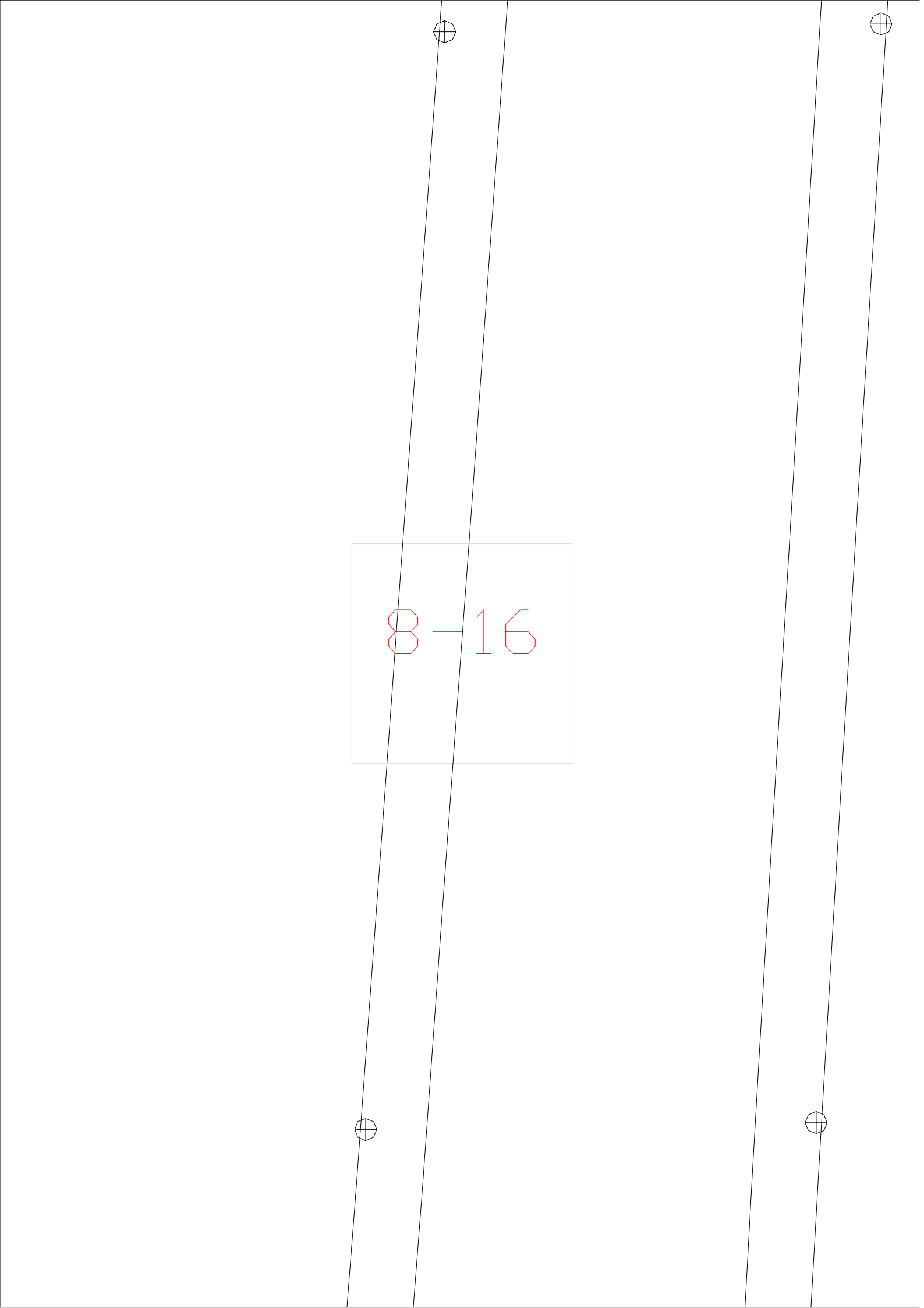

8-16

8-17

8-18

8-19



8-1

8-2

$$8 - 3$$

$$8 - 4$$

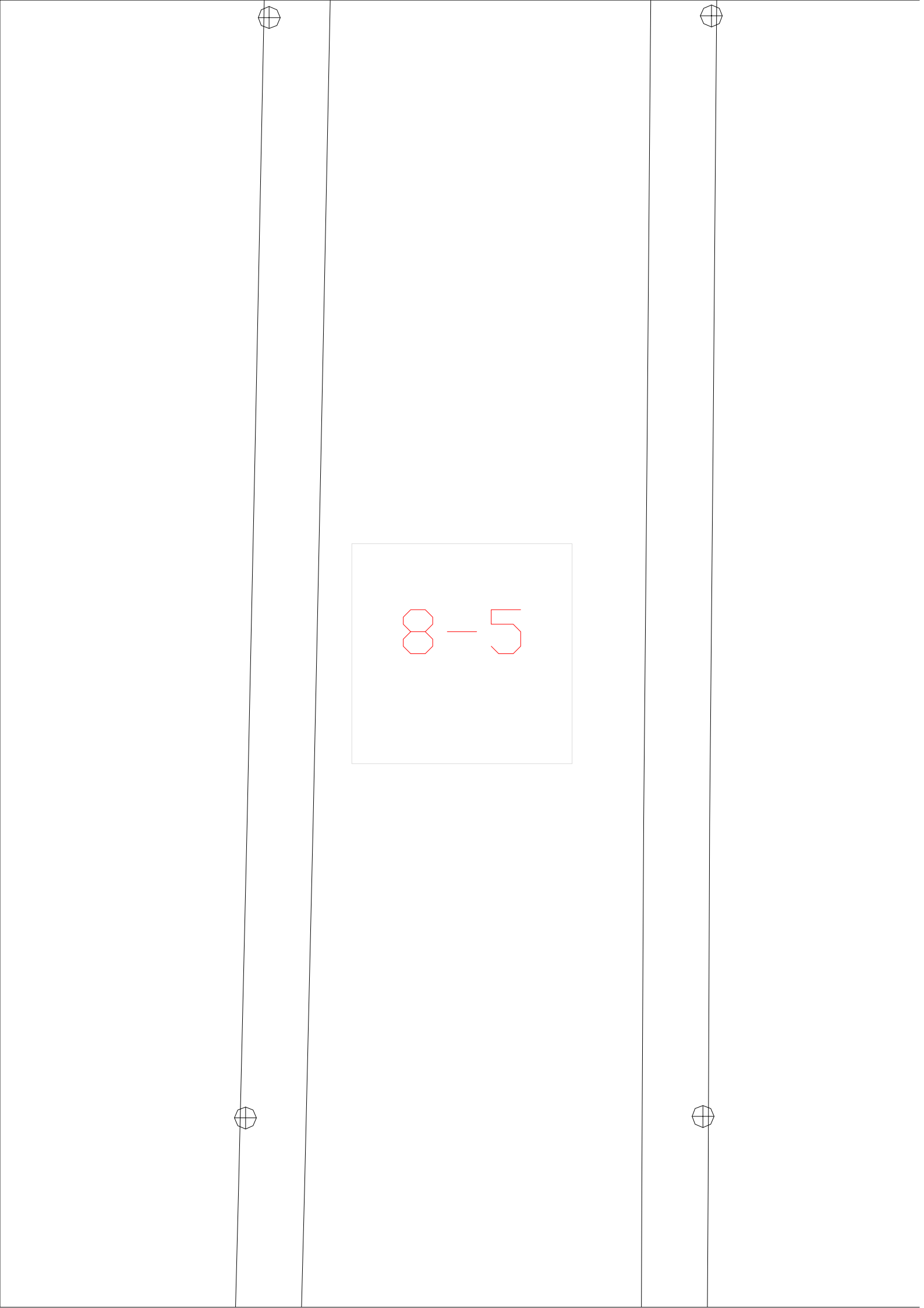
$$8 - 5$$

8-6

$$8 - 7$$



8-9

9-10



9-11



9-12



9-13

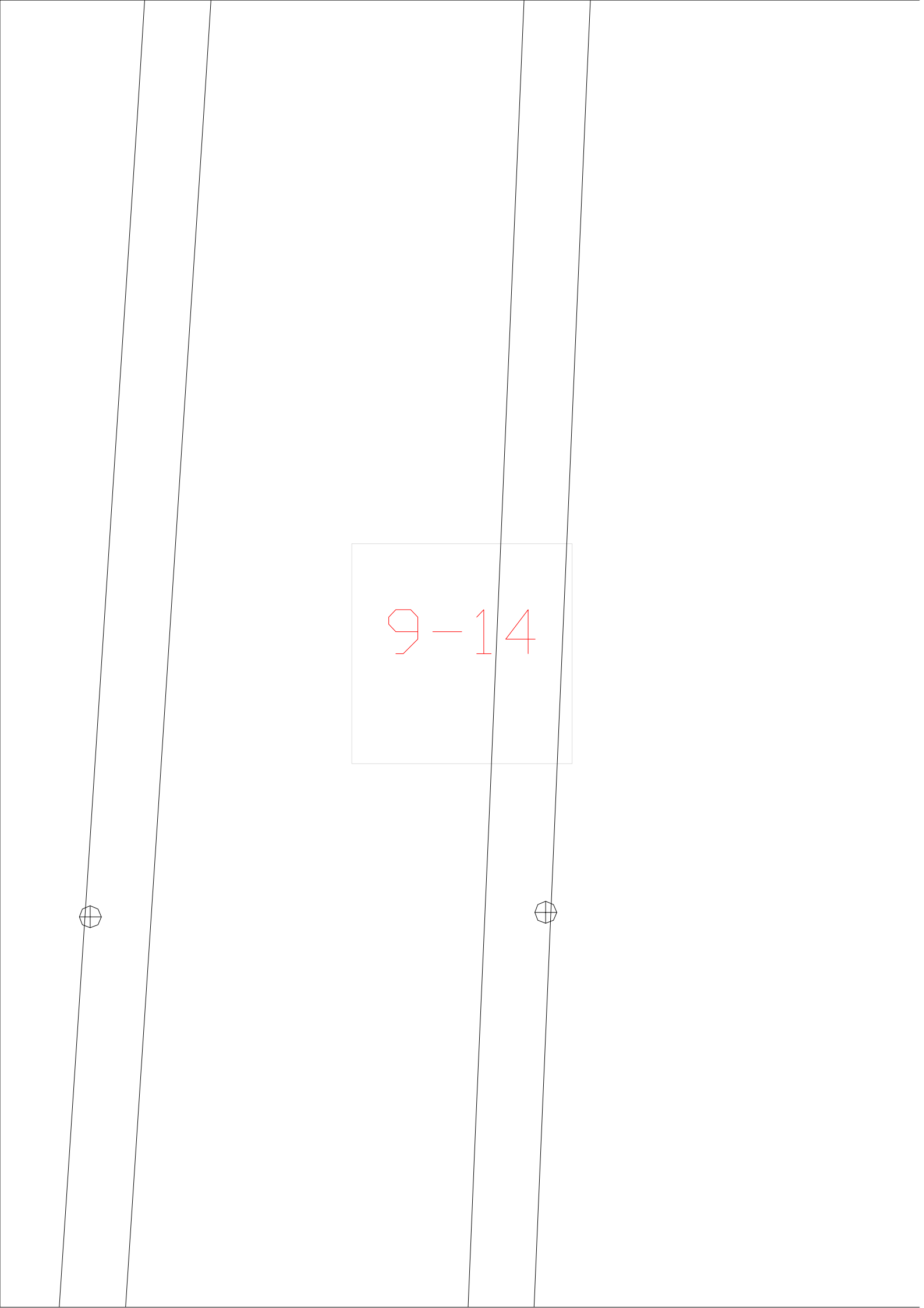

9-14

9-15

9-16



9-17

9-18



9-19

9-1



9-2

9-3

$$9 - 4$$

9-5



9-6

$$9 - 7$$



9 - 8

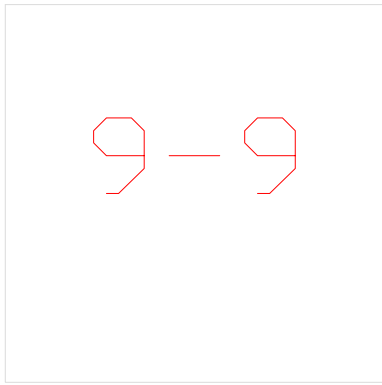

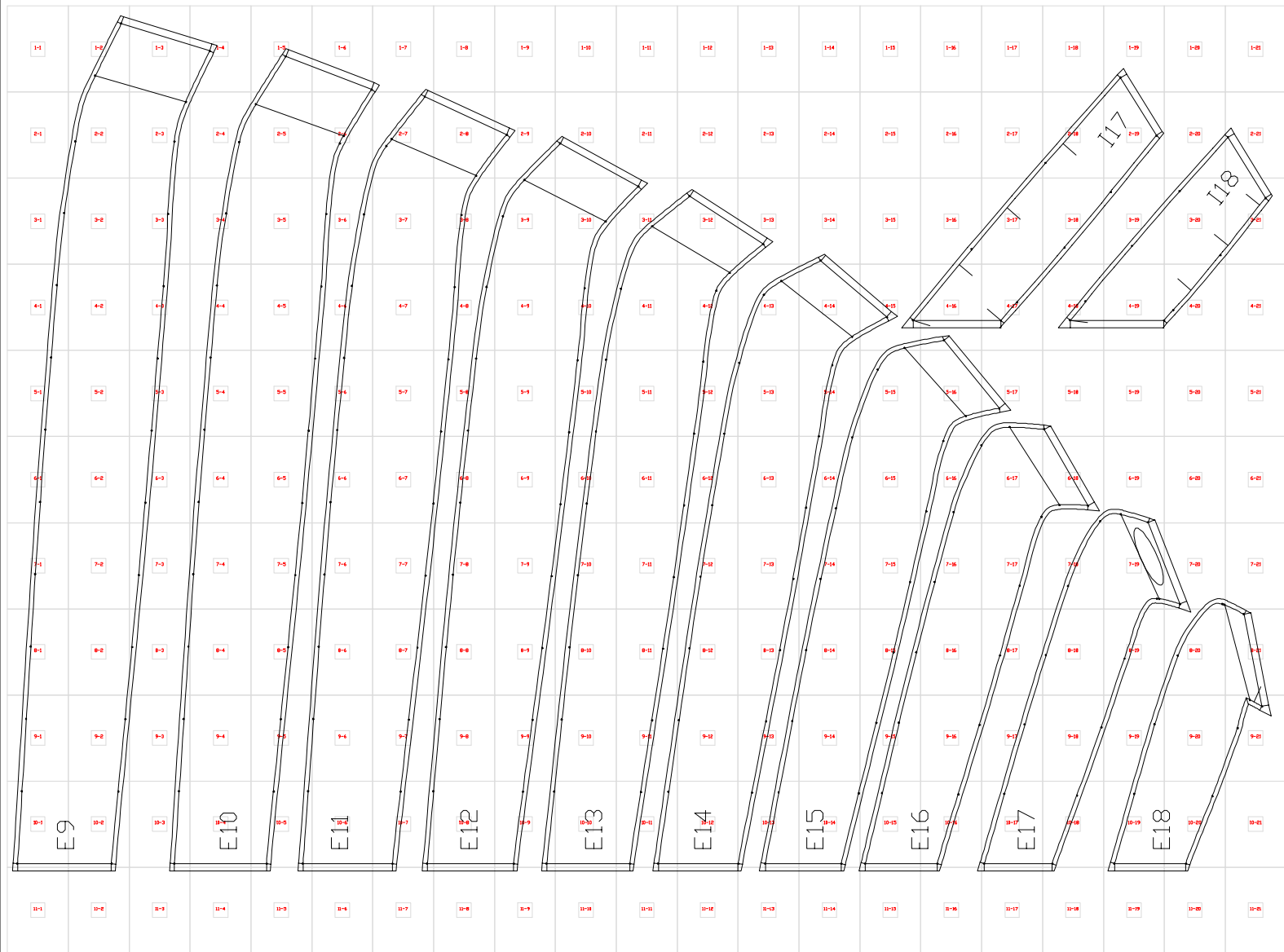

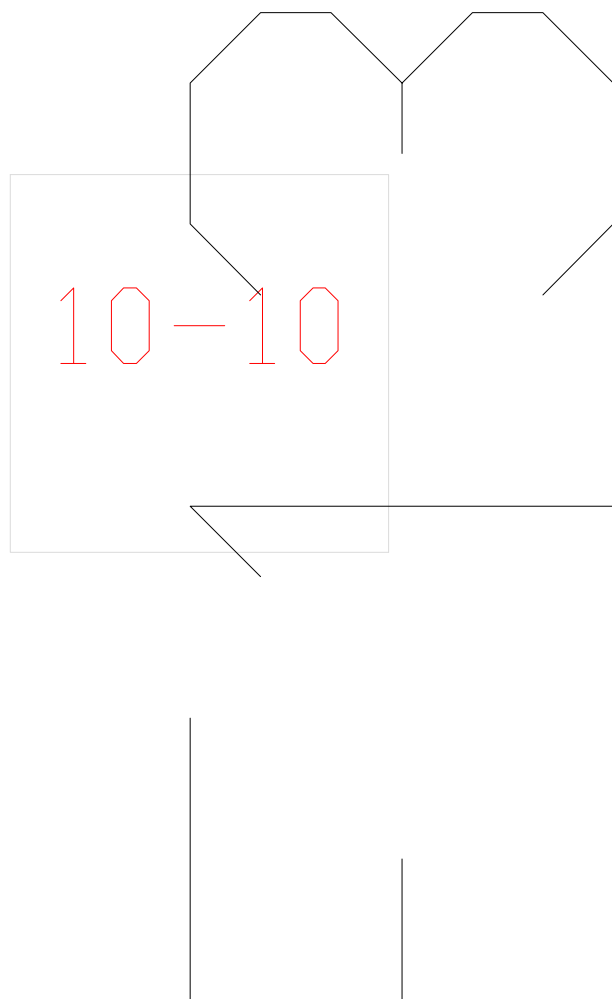

10-11

The image shows a technical drawing of a trapezoidal component. It features four circular holes, one at each corner. The holes are positioned at the intersections of the trapezoid's sides with a horizontal line extending from the bottom edge. A central rectangular box contains the text '10-11' in red. The drawing is composed of thin black lines on a white background.

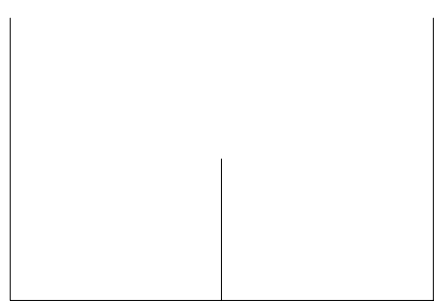
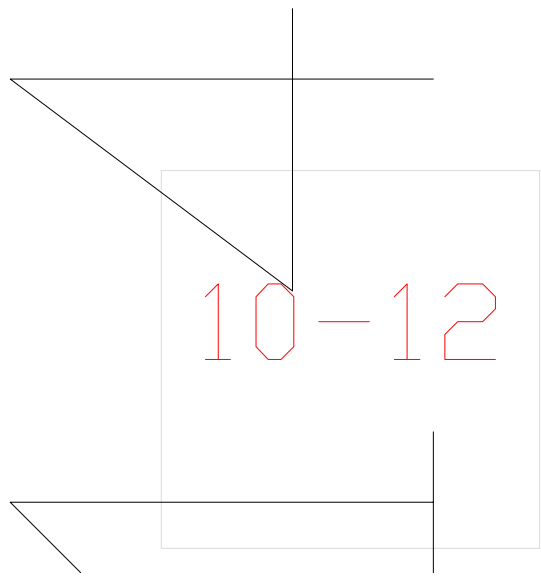

10-13

The image shows a technical drawing of a trapezoidal structure. It consists of two vertical lines on the left and right sides, and two slanted lines connecting them. There are four circular markers, each with a cross inside, located at the corners of the trapezoid. A central rectangular box contains the text '10-13' in red.

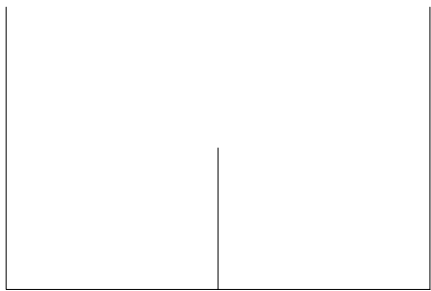
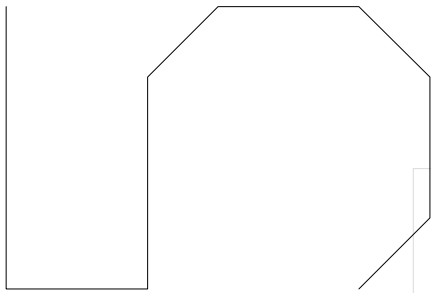

10-14



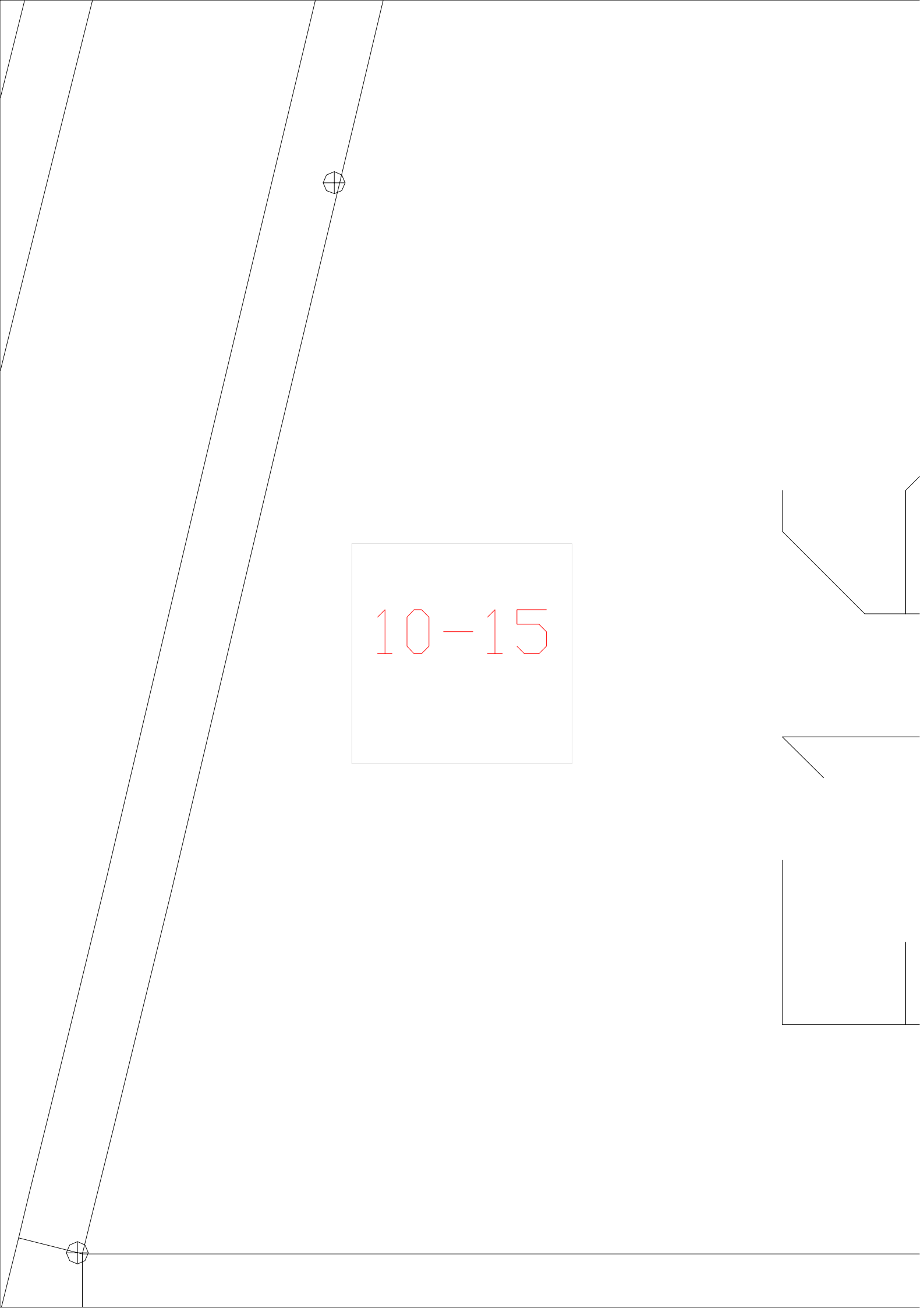

10-15

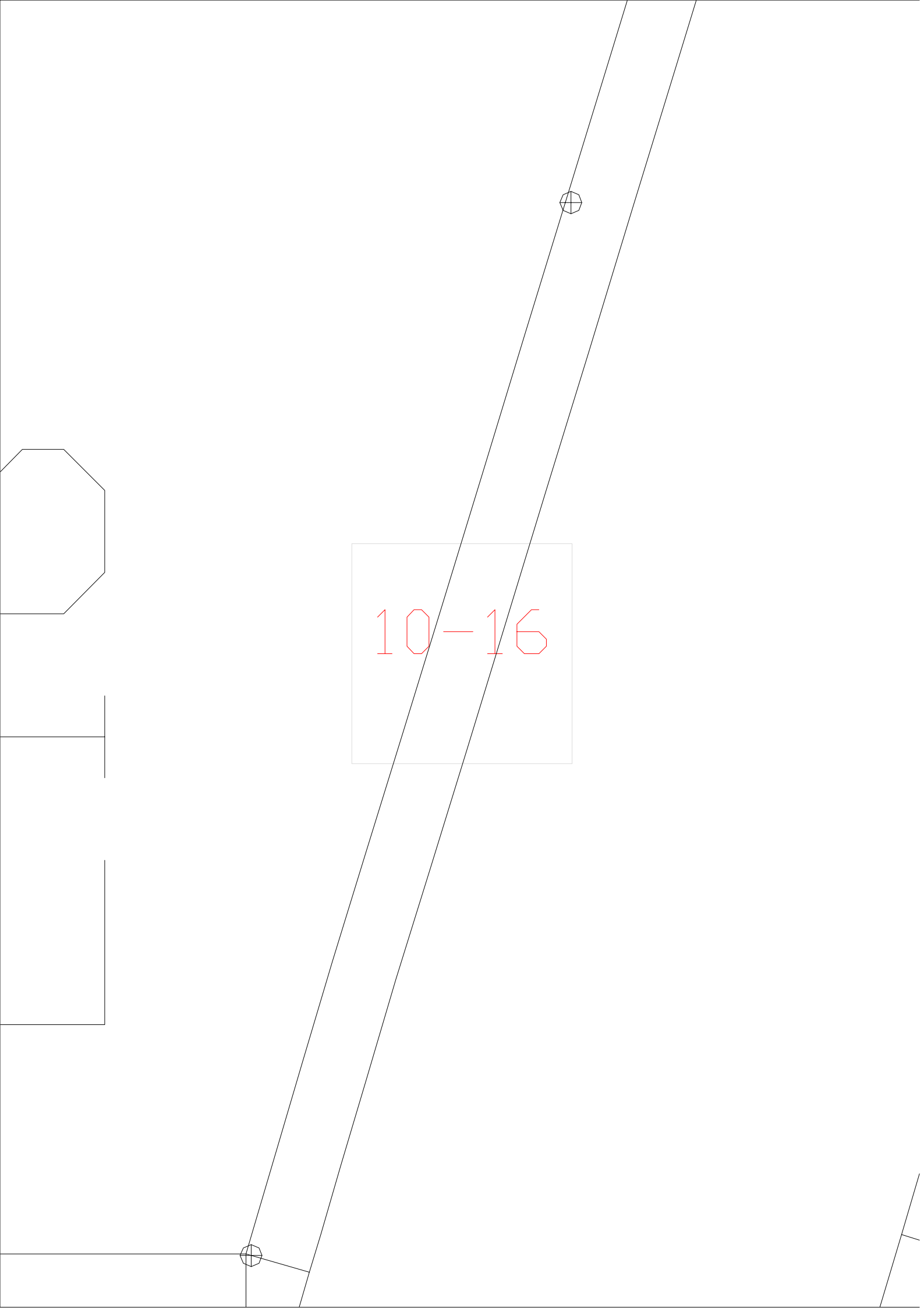

10-16

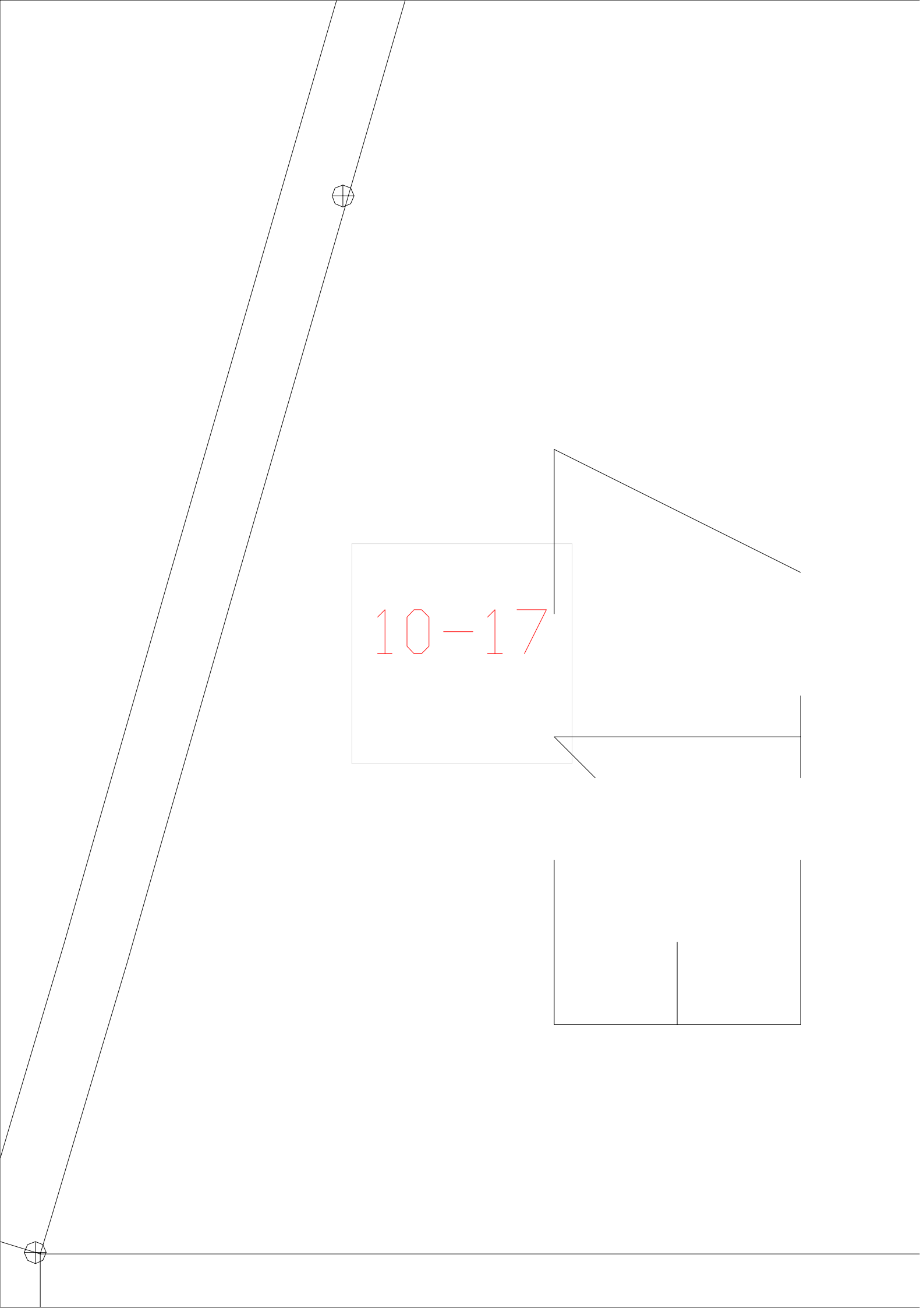

10-17

10-18

The image shows a technical drawing of a tapered shaft. The shaft is represented by two parallel lines that converge towards the right, indicating a taper. There are two circular features on the shaft, one at the bottom left and one higher up. The central part of the shaft is enclosed in a rectangular box containing the text '10-18' in red.

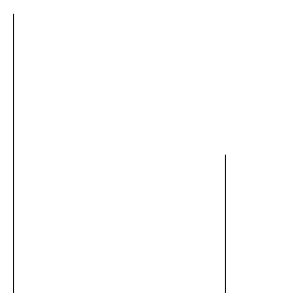
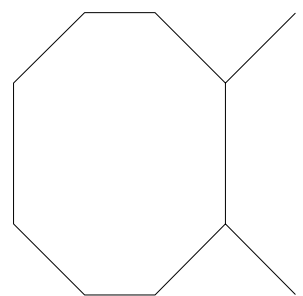

10-19





10-1

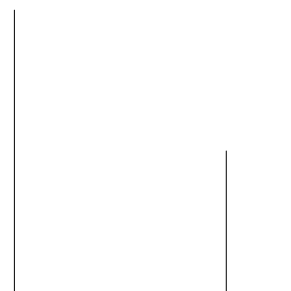
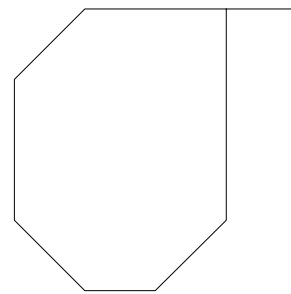

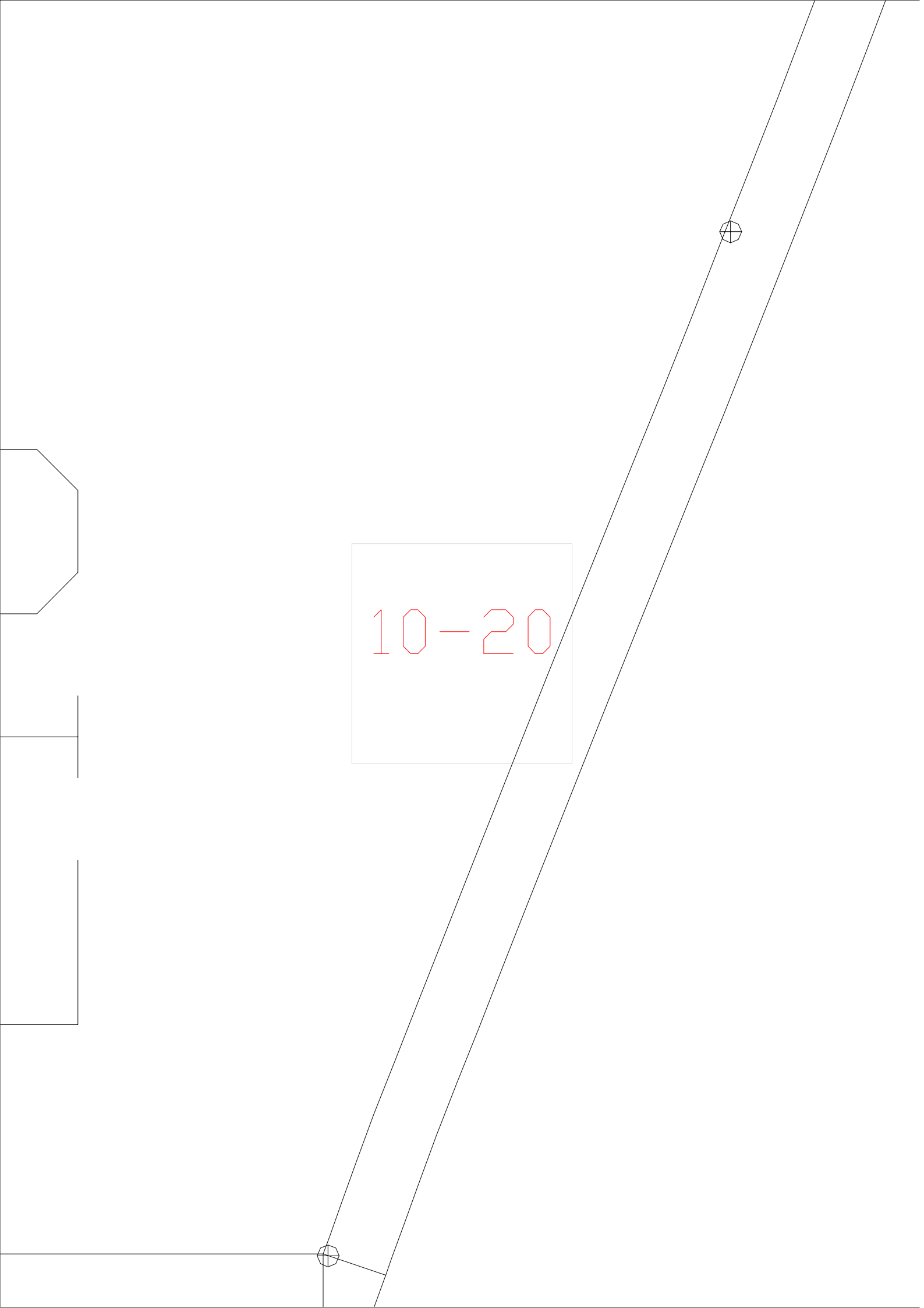

10-20

10-21

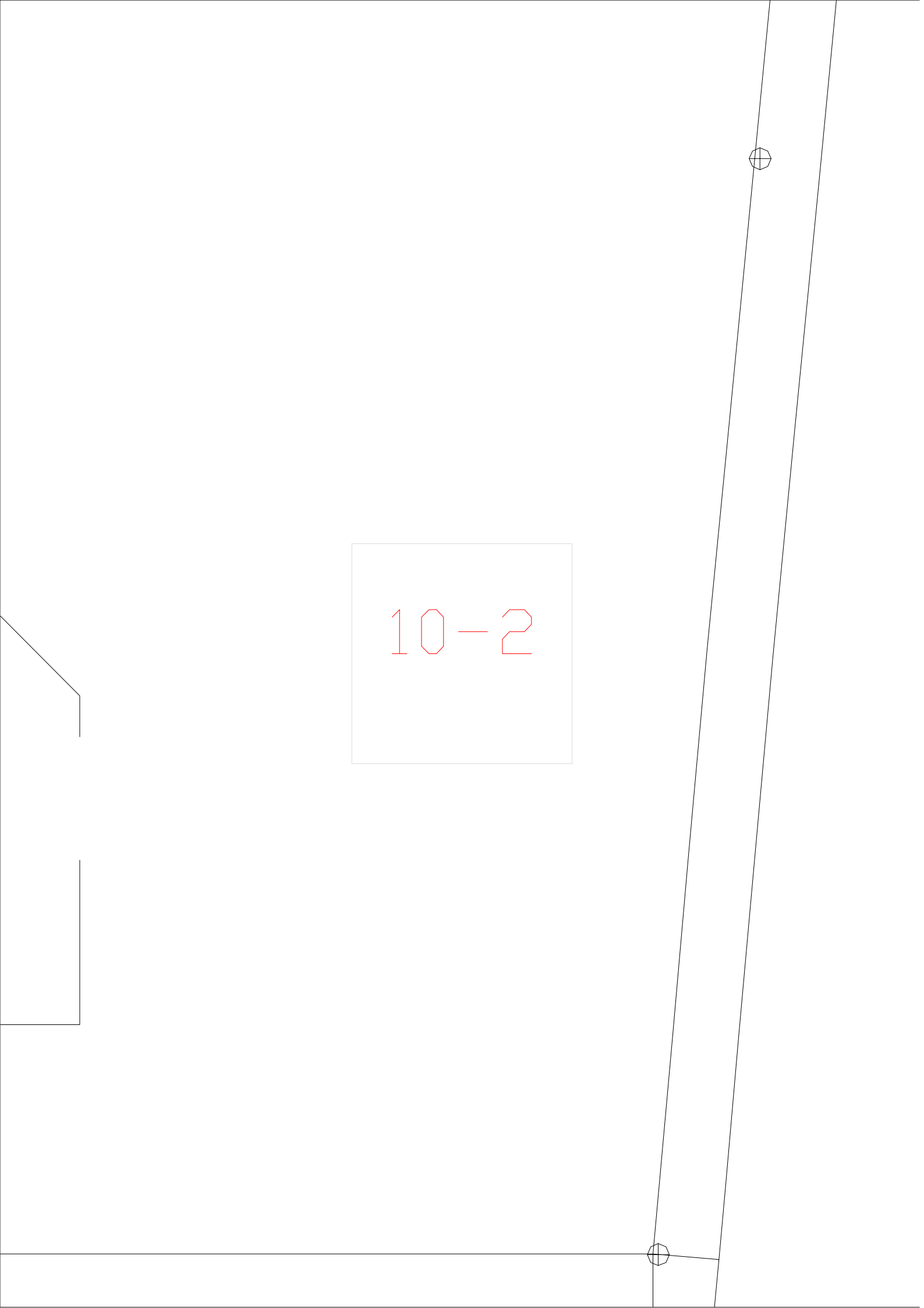

10-2

The image shows a technical drawing of a rectangular plate. The plate has a central rectangular hole. On the right side, there is a slanted edge. Two circular features, possibly representing holes or fasteners, are located on the right side of the plate. The text '10-2' is centered within the plate's outline.

10-3



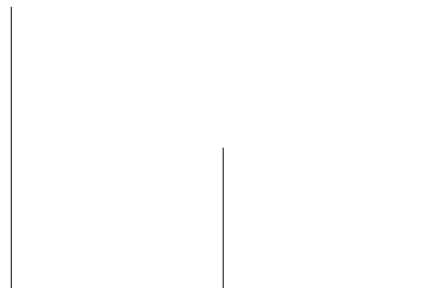
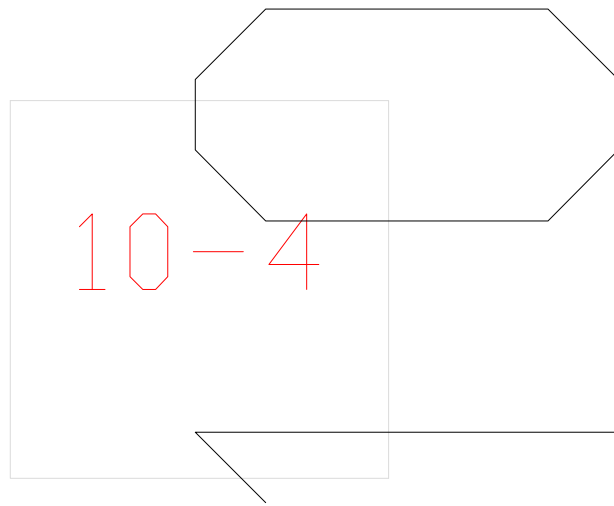

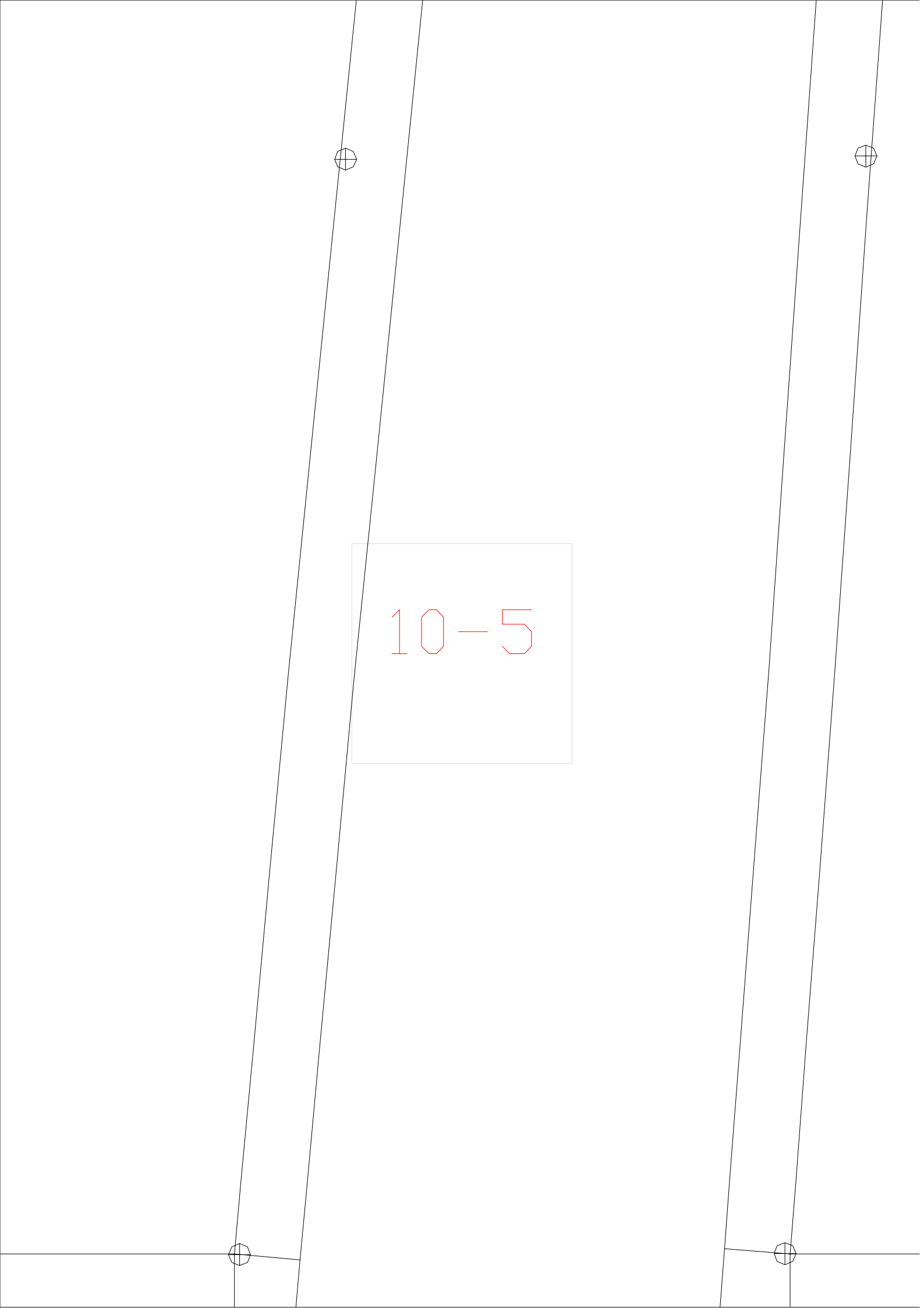

10-5

The image shows a technical drawing of a trapezoidal component. The drawing consists of two parallel vertical lines representing the main body, with a wider top edge and a narrower bottom edge. At the top and bottom corners, there are small circular features with a cross inside, likely representing mounting holes or fasteners. A central rectangular box contains the text '10-5' in red. The drawing is oriented vertically on the page.

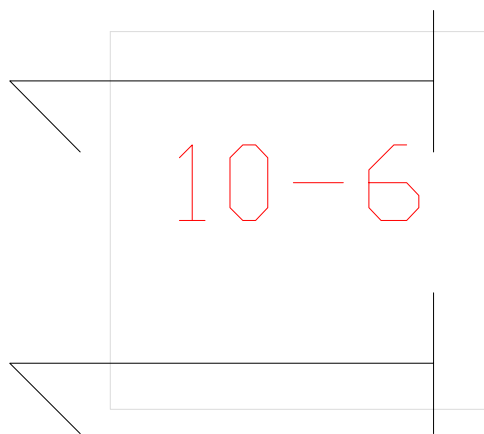

10-6

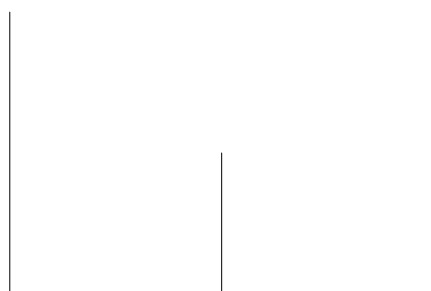

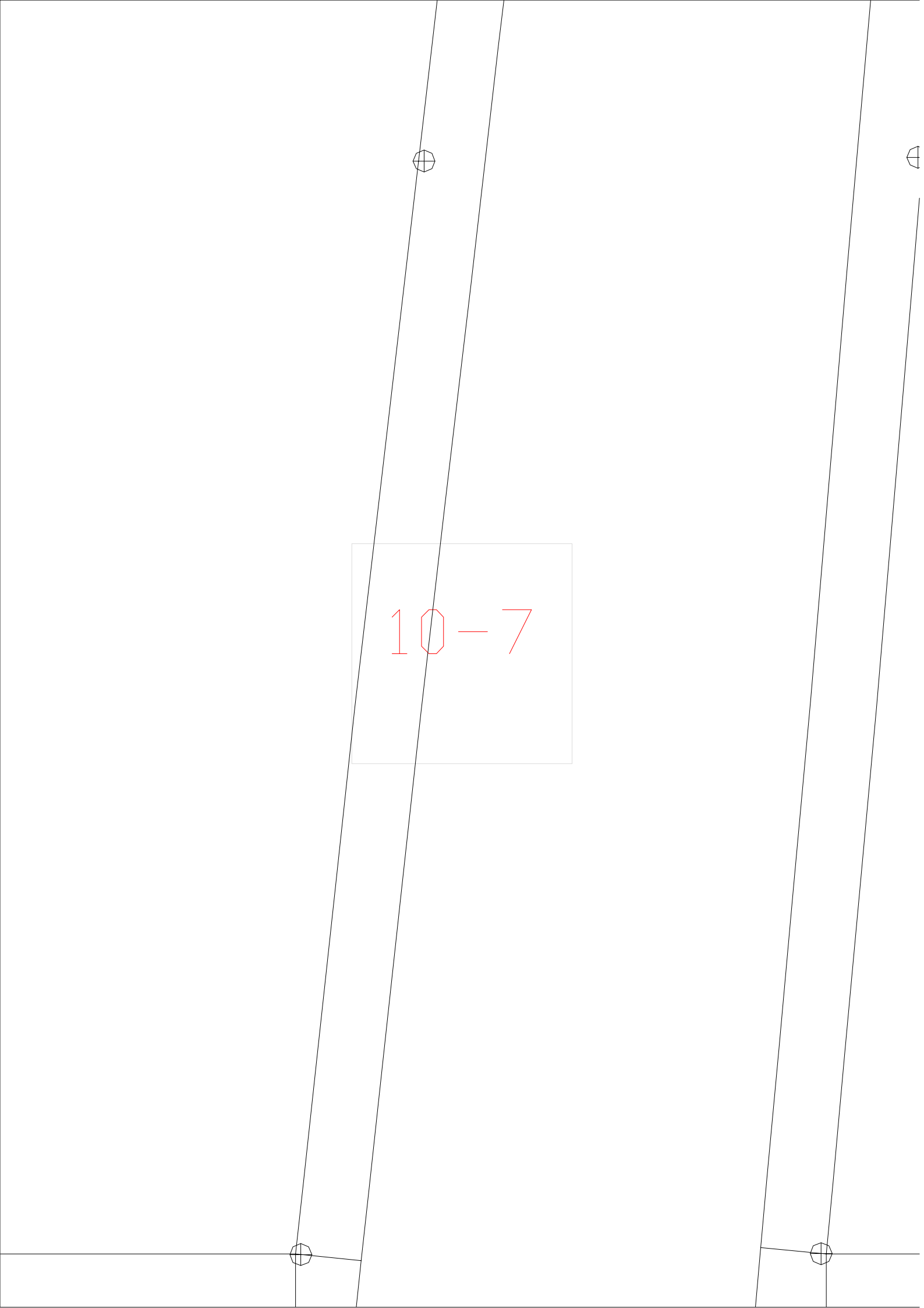

The image shows a technical drawing of a mechanical part, possibly a shaft or a rod, with several features. A central rectangular box contains the text "10-7" in red. The drawing includes several lines representing the geometry of the part, including a central vertical line and two parallel lines on either side. There are four circular features, each with a crosshair, located at the top and bottom of the central vertical line and at the top and bottom of the rightmost parallel line. The text "10-7" is positioned in the center of the drawing, between the two parallel lines.

10-7

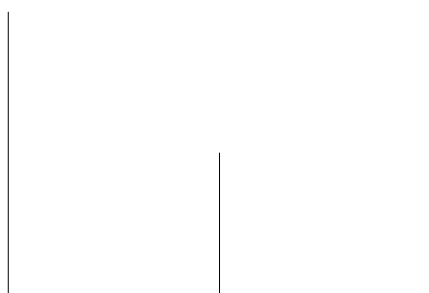
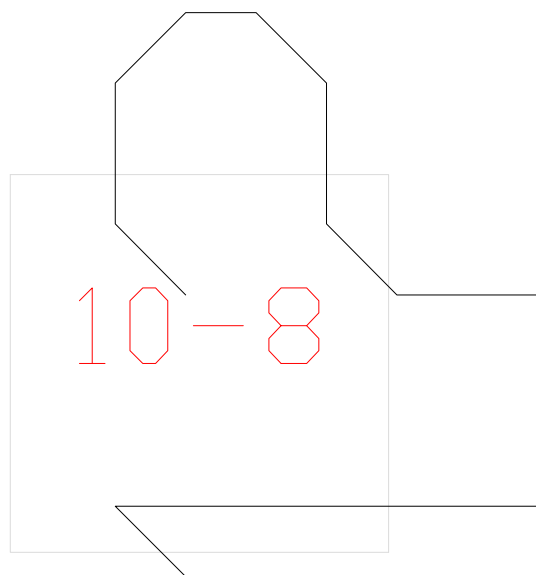

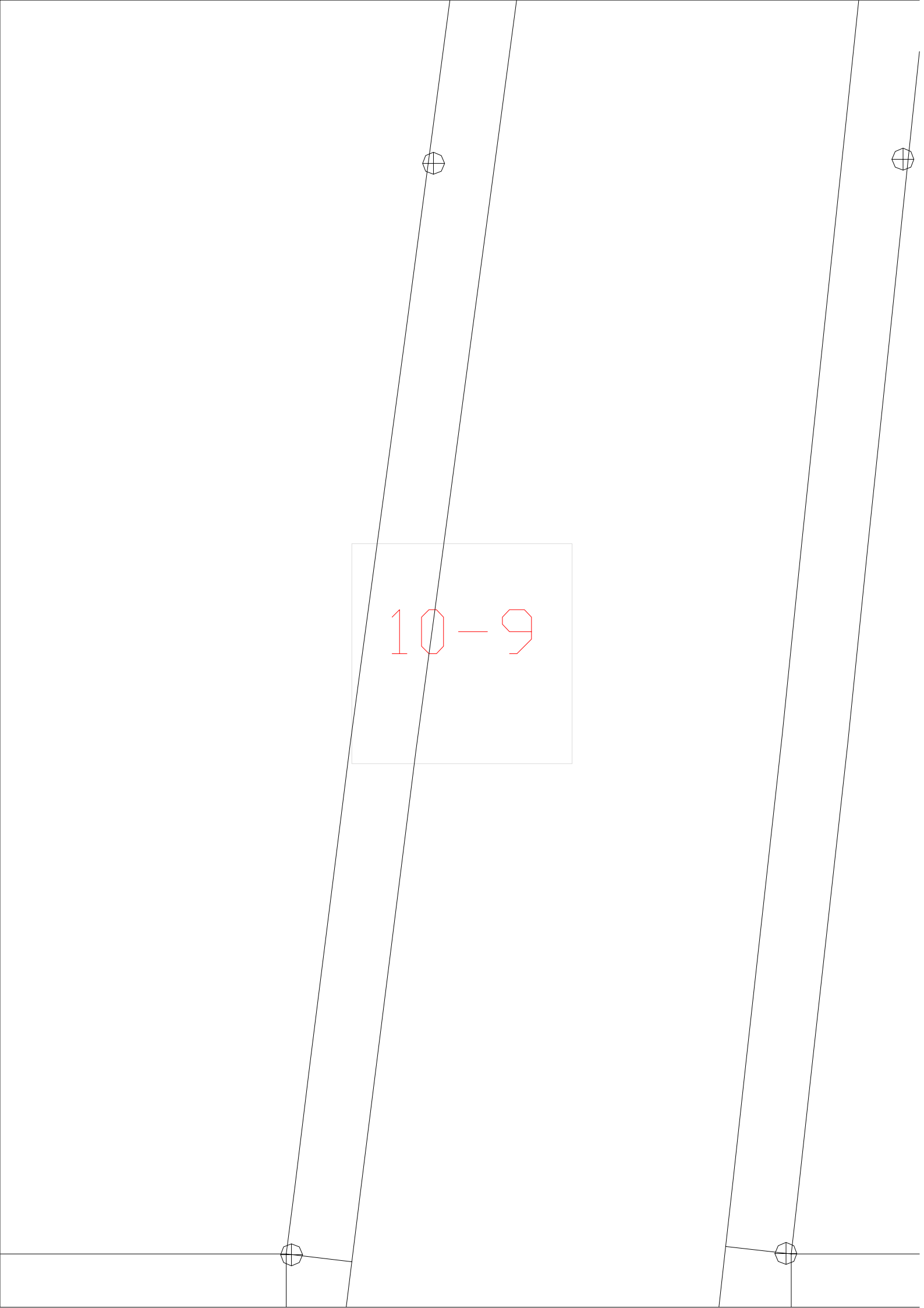

10-9

The image shows a technical drawing of a mechanical part, possibly a shaft or a rod, with a central label '10-9' enclosed in a light blue box. The drawing features two parallel lines representing the main body of the part, with four circular features (likely holes or fasteners) positioned at the top and bottom. The top features are located on the upper lines, and the bottom features are located on the lower lines. The label '10-9' is centered between the two main lines.

1-10

11-10

11-11

11-12

11-13

11-14

11-15

11-16

11-17

11-18

11-19

1 - 11

$$11 - 1$$

11-20

11-21

1-12

11-2

1-13

--	--

11-3

$$11 - 4$$

1-15

11-5

1-16

11-6

$$11 - 7$$

1-18

$$11 - 8$$

1-19

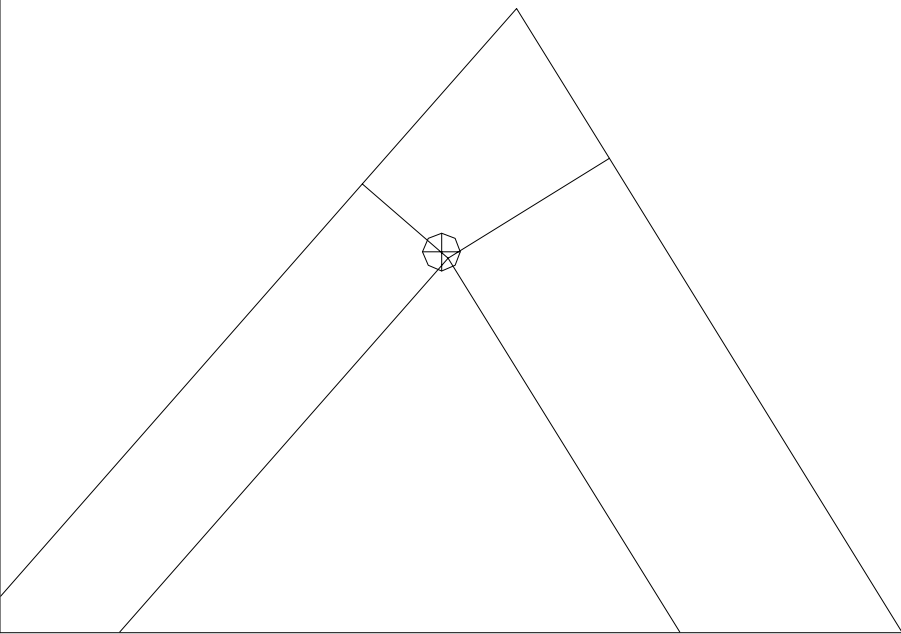

11-9

1 - 1

1-20

1-21

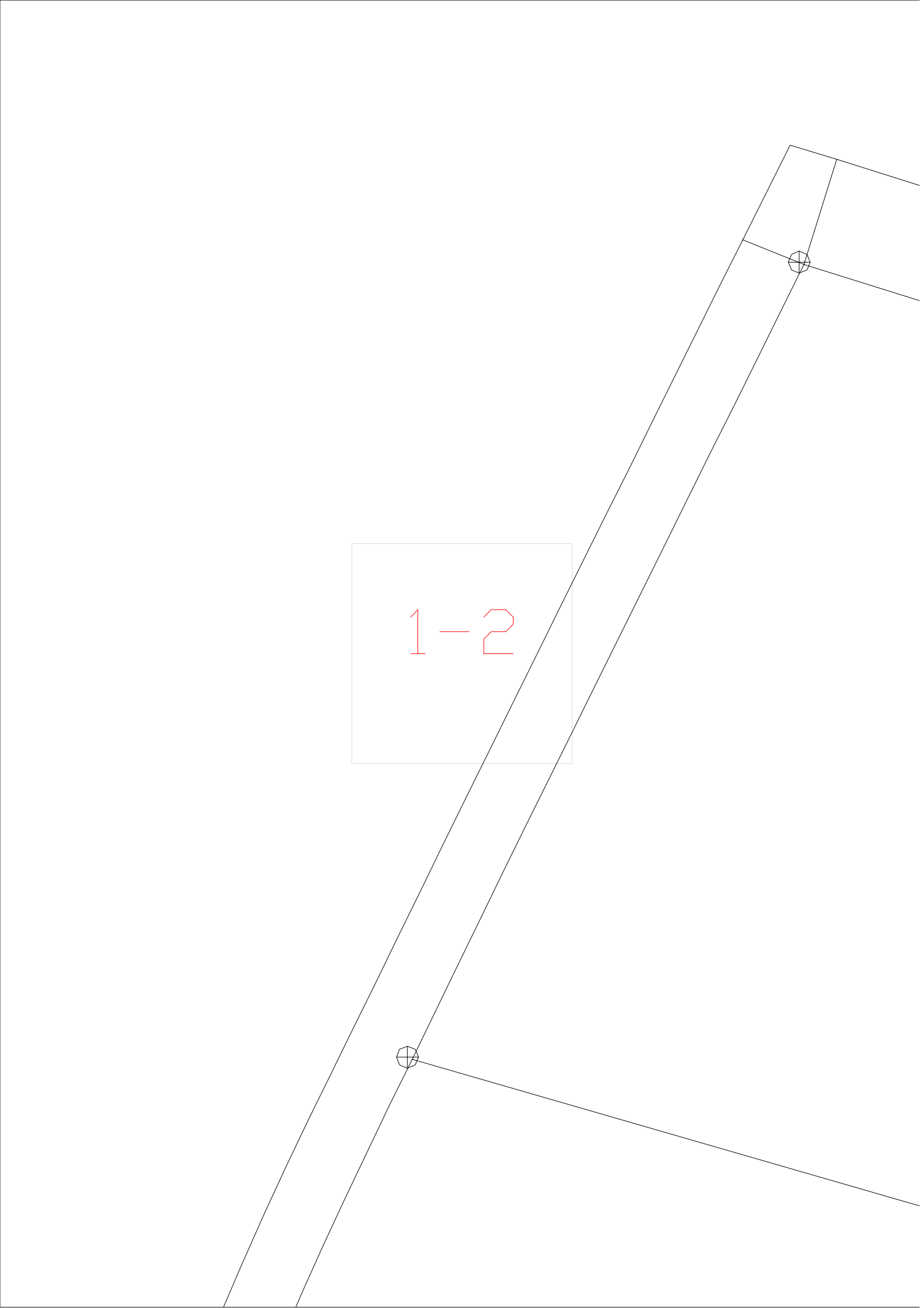

1-2

The image shows a technical drawing of a mechanical part, possibly a shaft or a rod, oriented diagonally. A section line is drawn across the part, with a circular symbol at the top end. A callout box, outlined in light gray, is positioned in the center of the drawing and contains the text "1-2" in red. The drawing is composed of several lines representing the geometry of the part, including a main shaft and a flange-like structure at the top right.

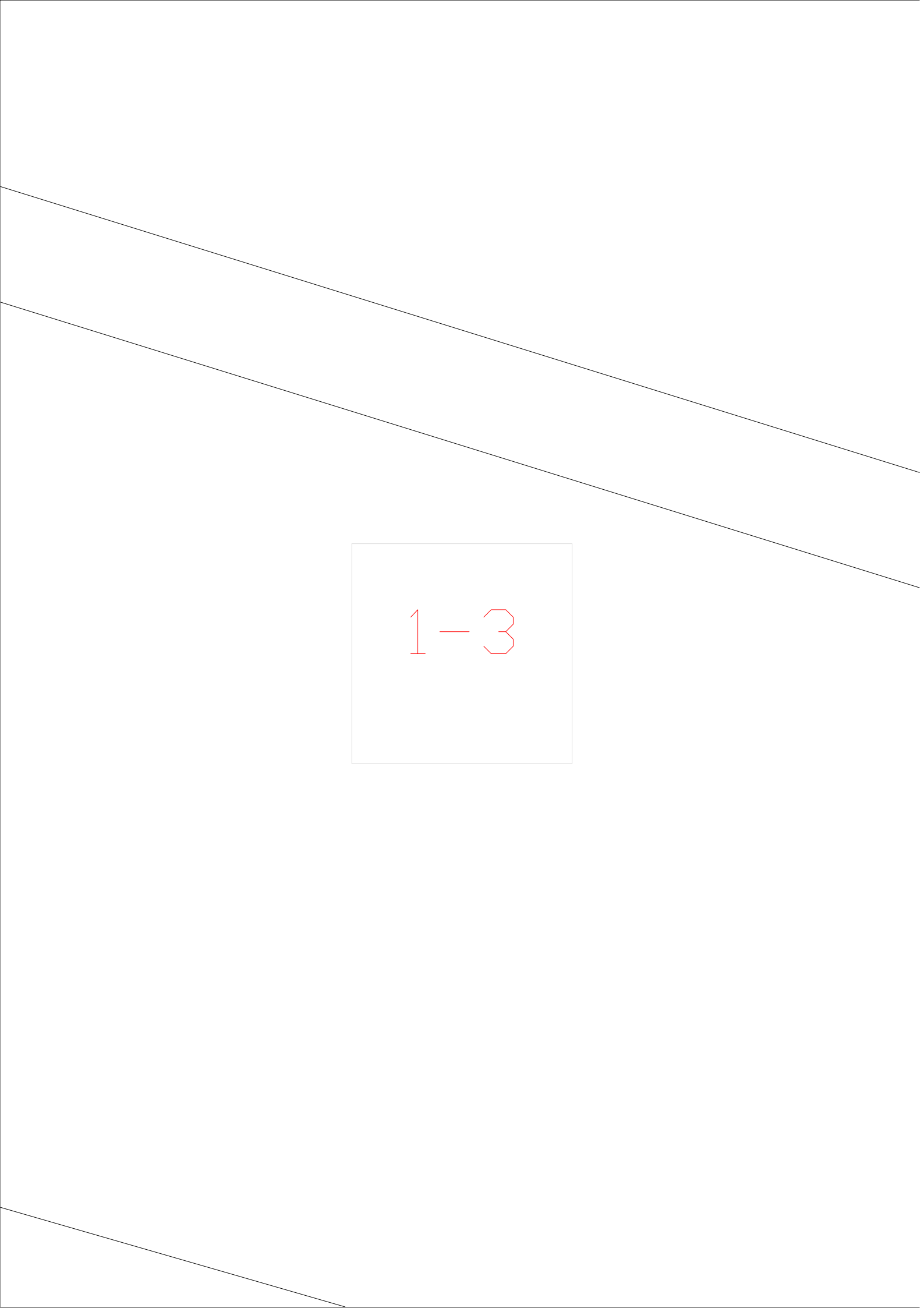

1-3

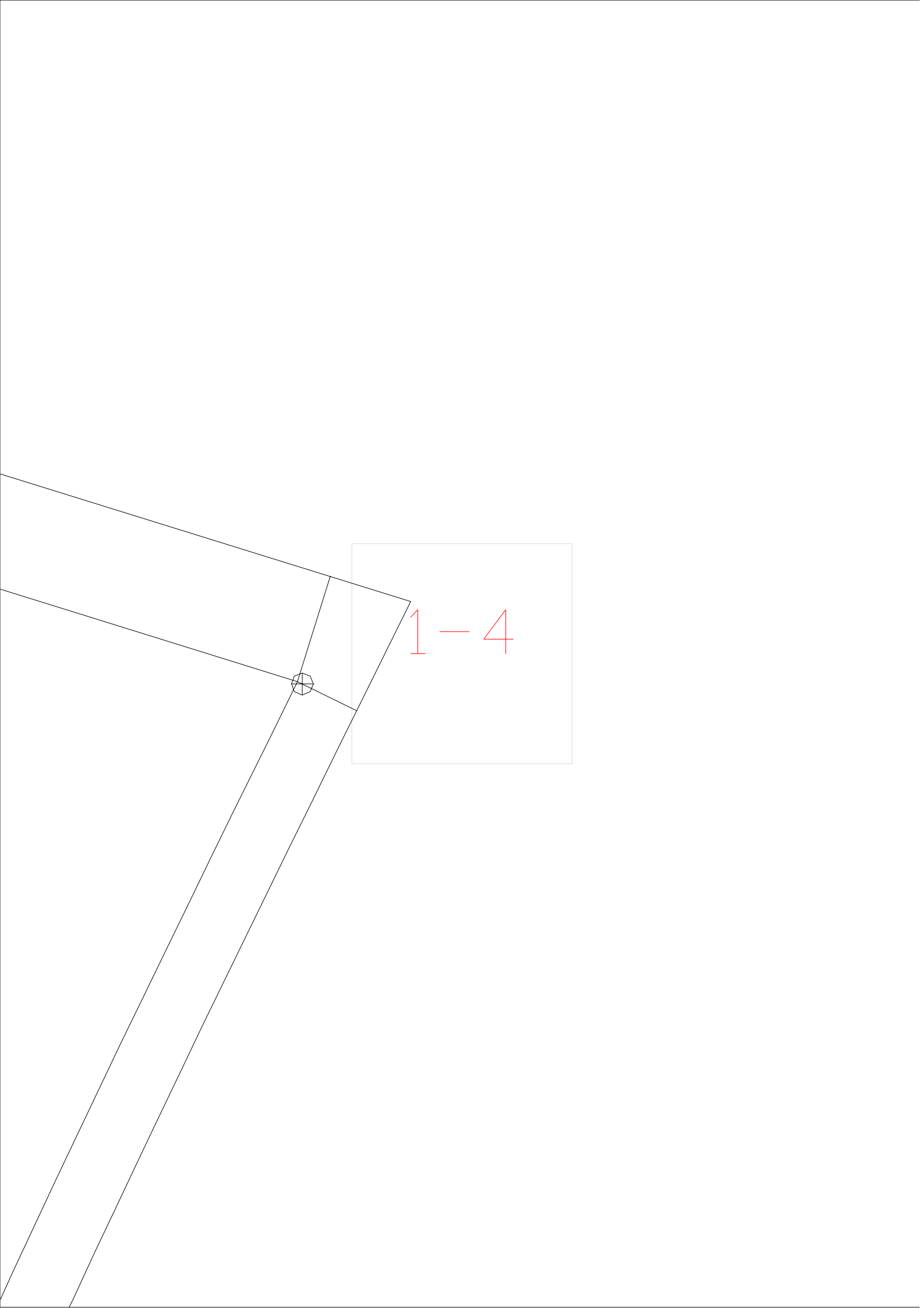

1-4

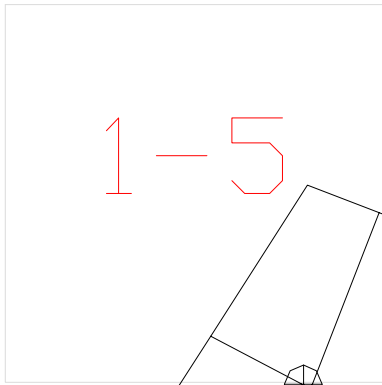

1-6



1-7

1-8

1-9

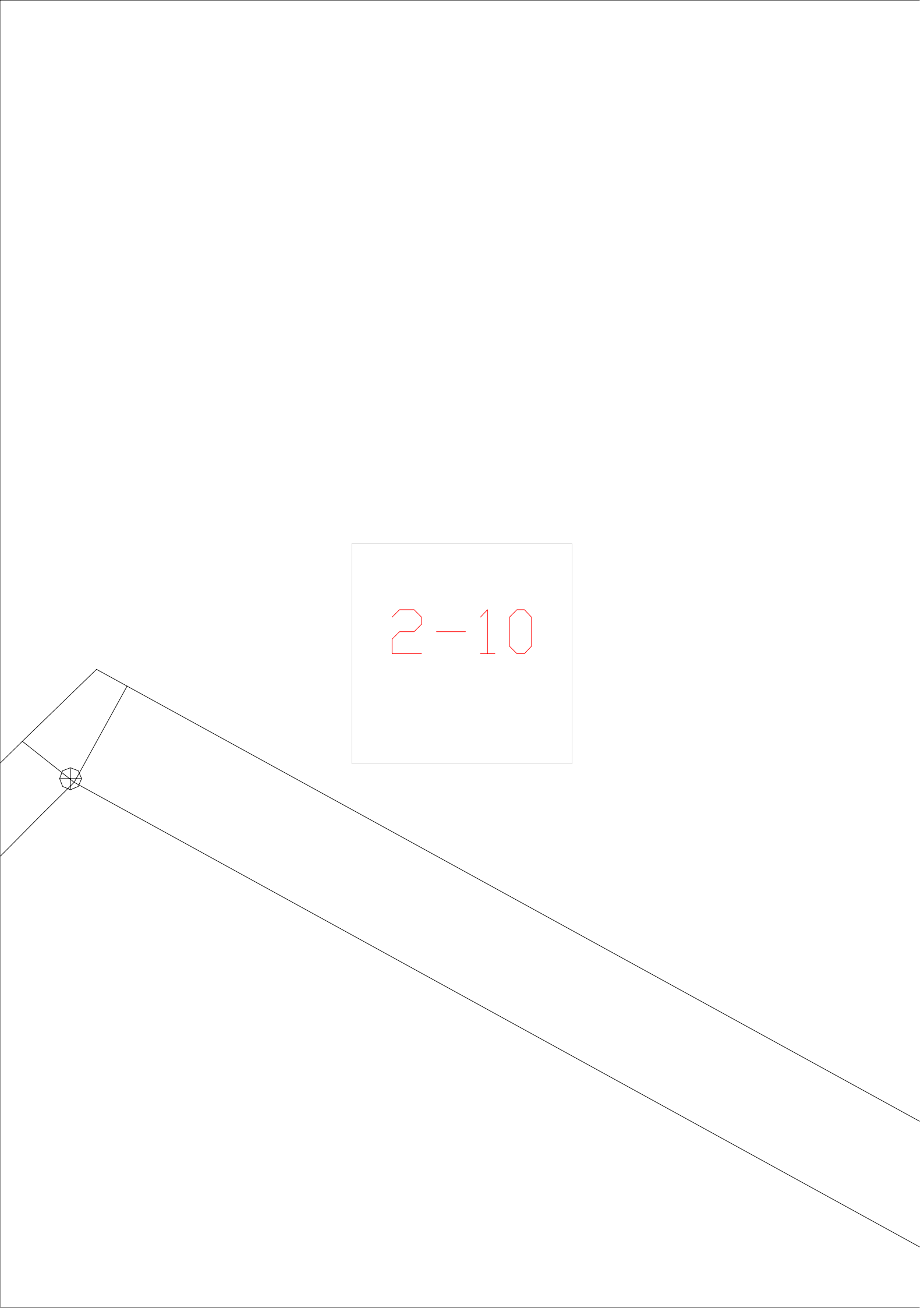

2-10

The image shows a technical drawing of a roof structure. On the left, a circular detail with a crosshair is shown, representing a fastener or joint. Several lines radiate from this point, defining the geometry of the roof. A rectangular callout box with a thin border is positioned in the upper-middle section of the drawing, containing the red text '2-10'.

2-11

2-12

2-13

2-14

2-15

2-16

2-17

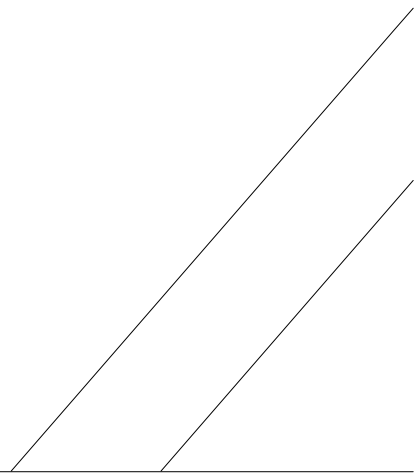

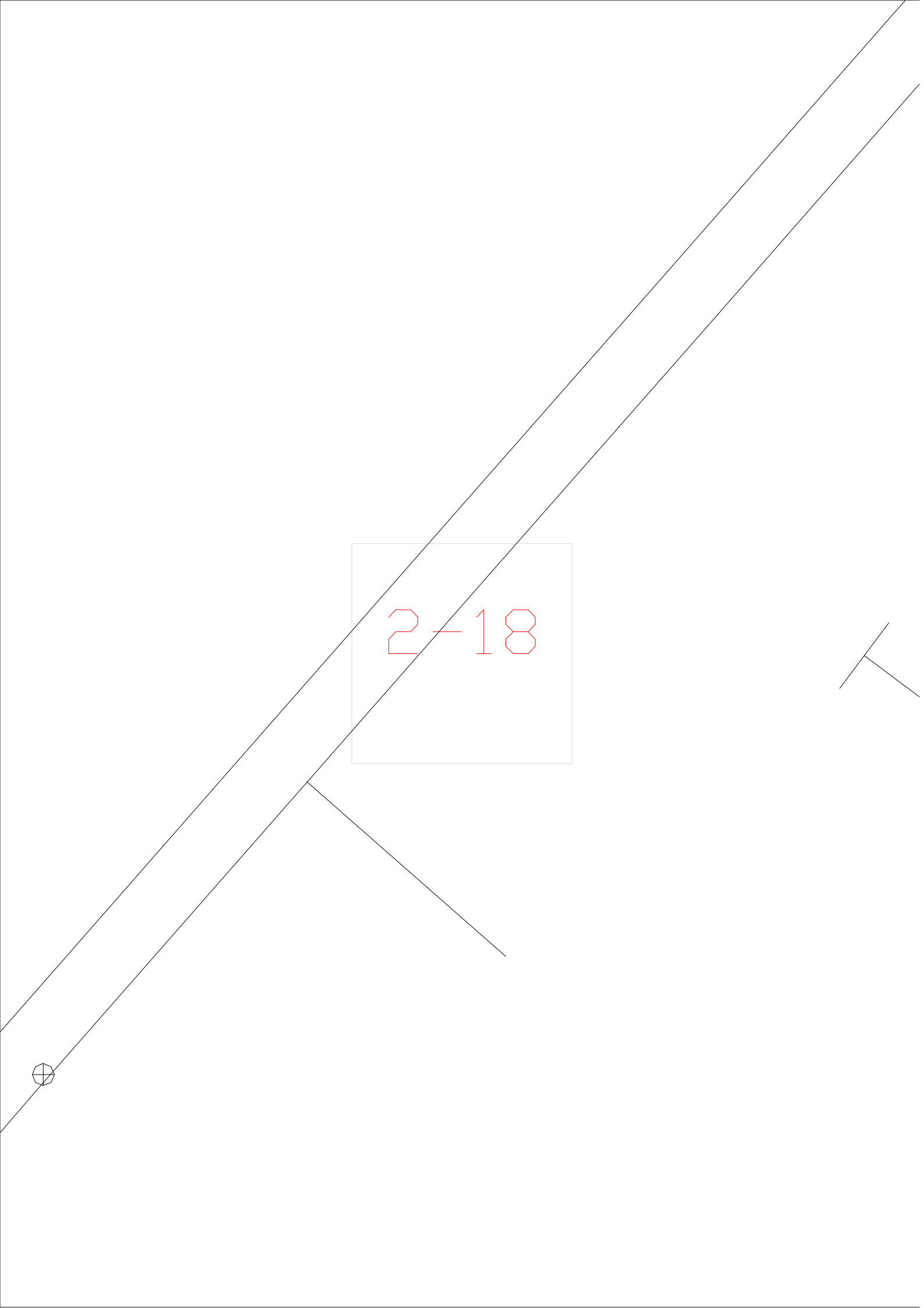

2-18

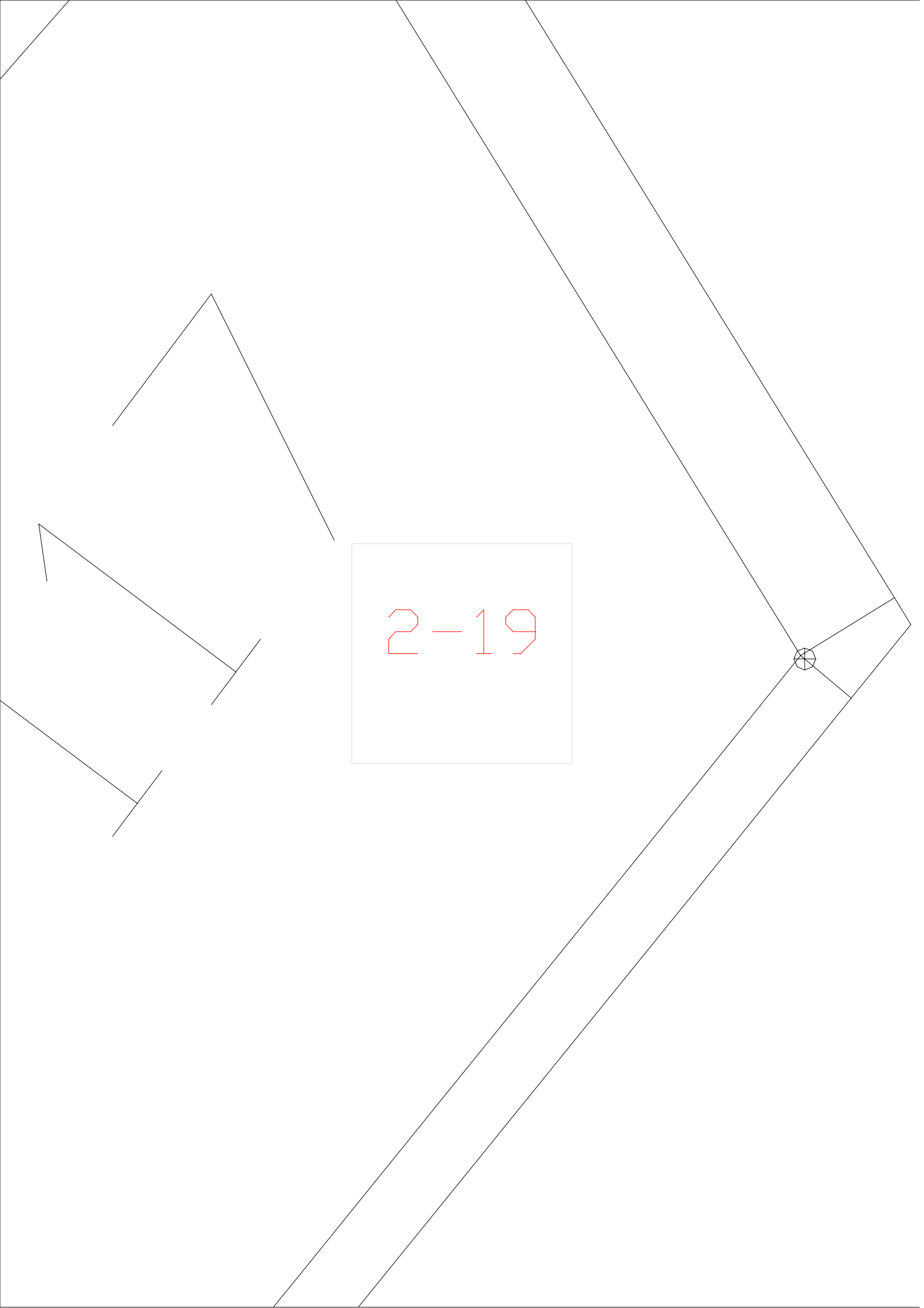

2-19

2-1

2-20

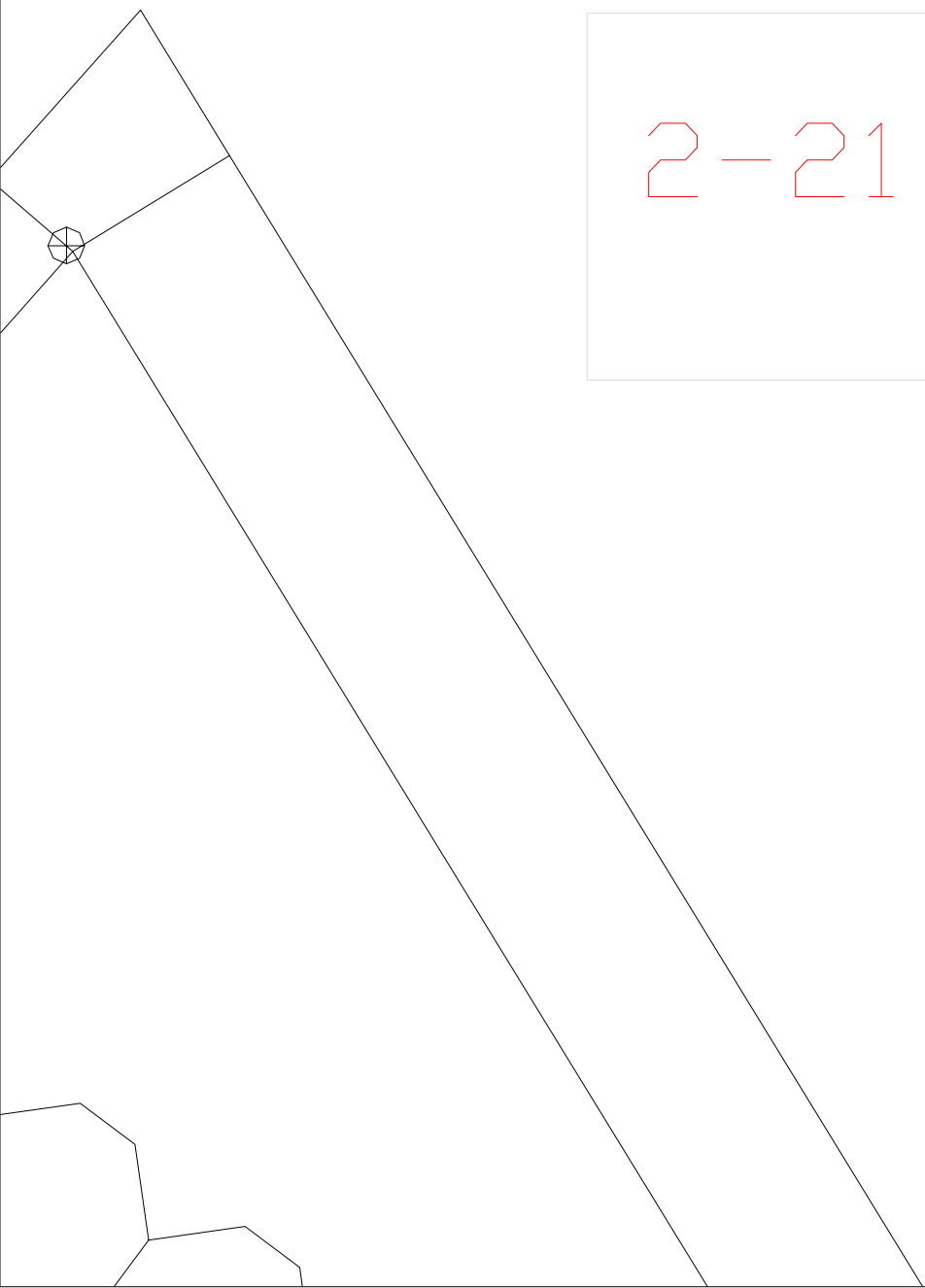

2-21

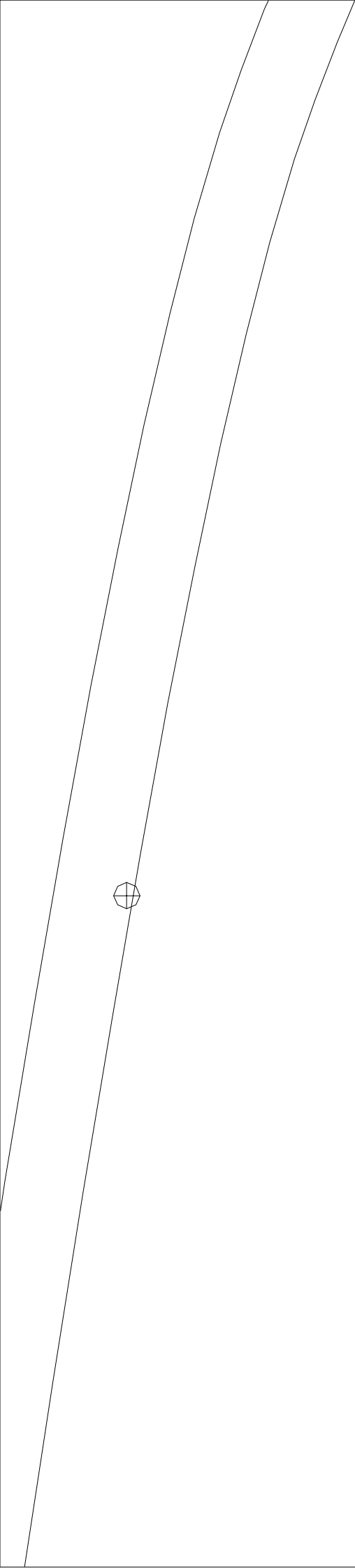

2-2

2-3



2-4





2-5

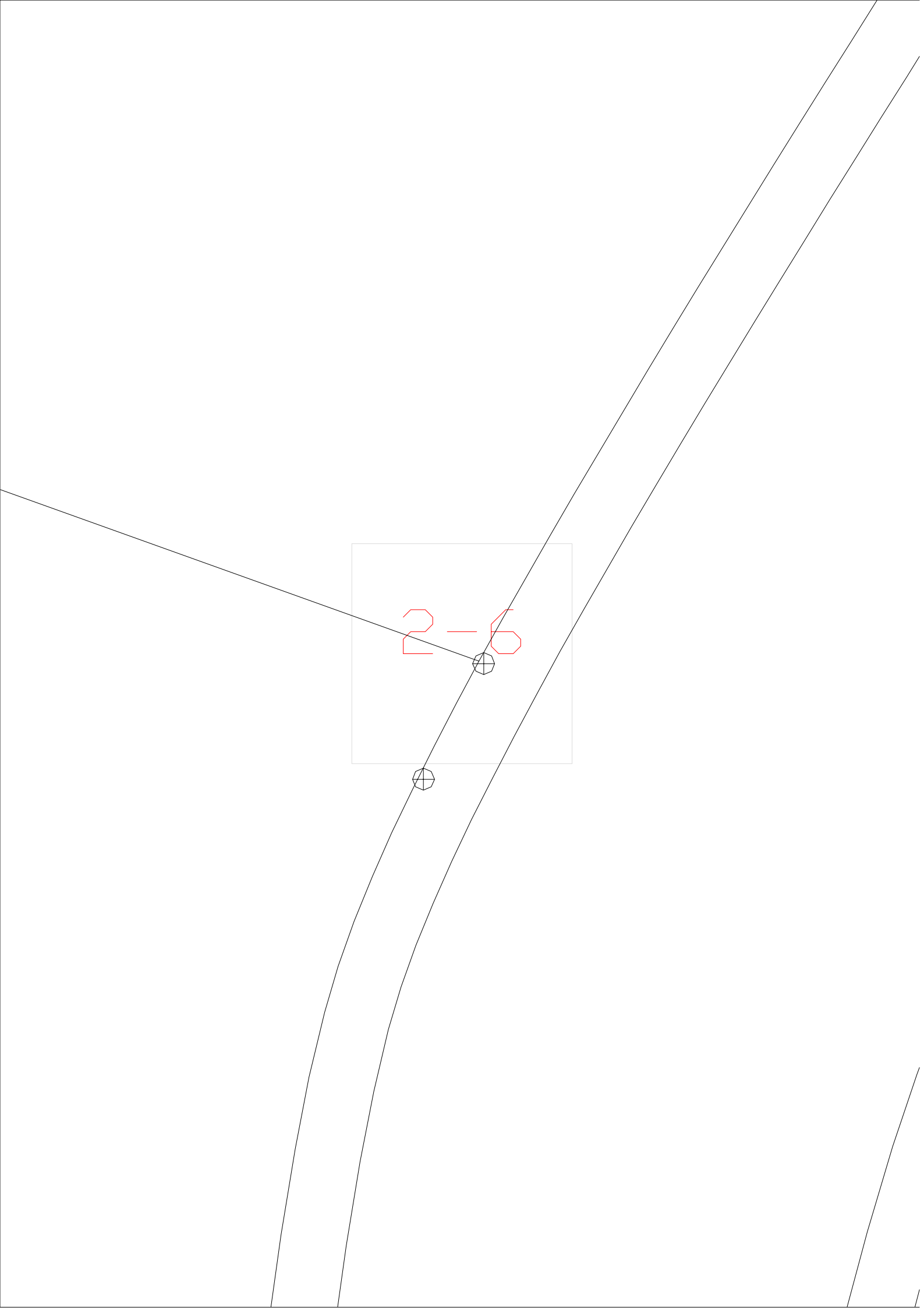

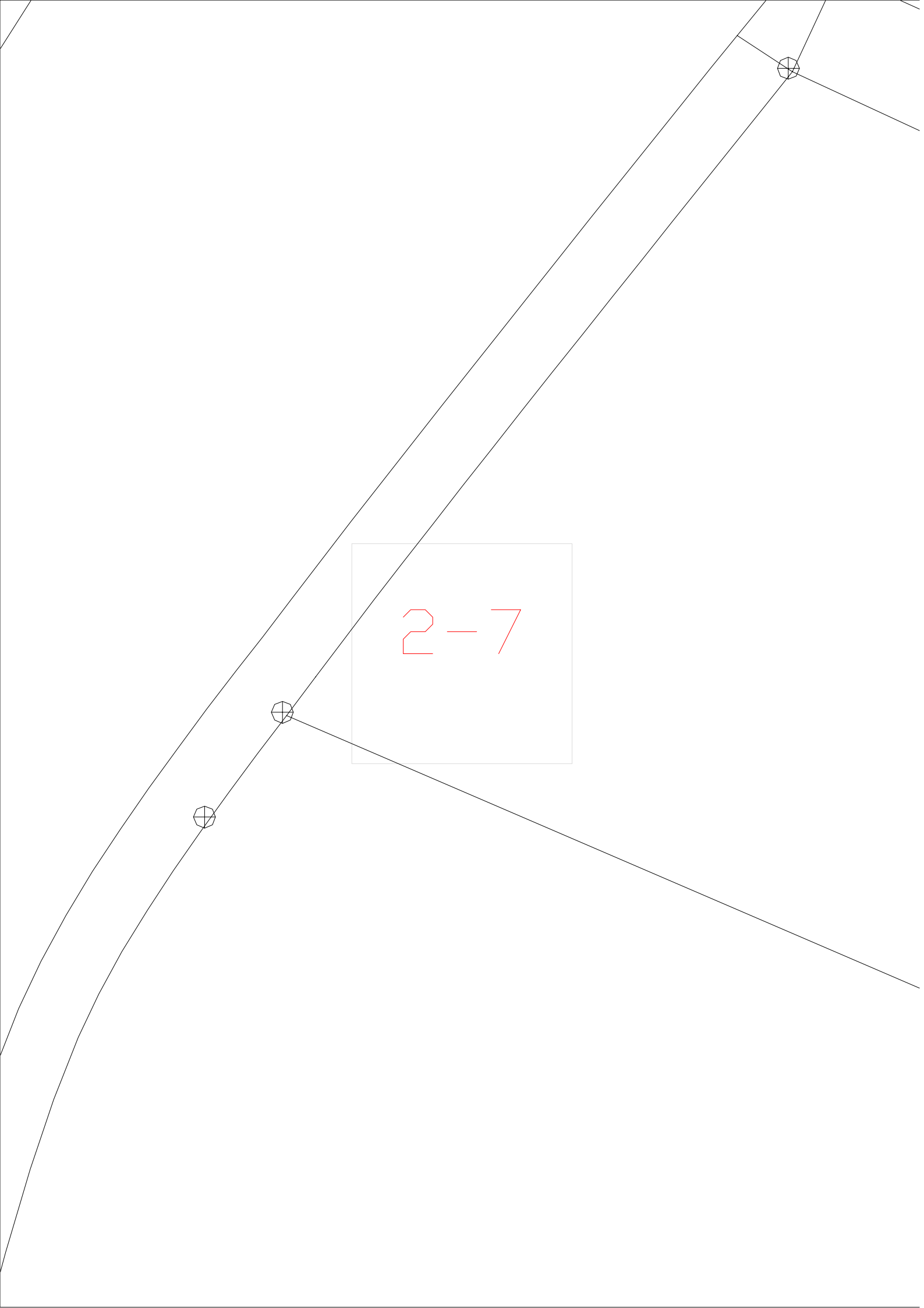

2-7



2-8

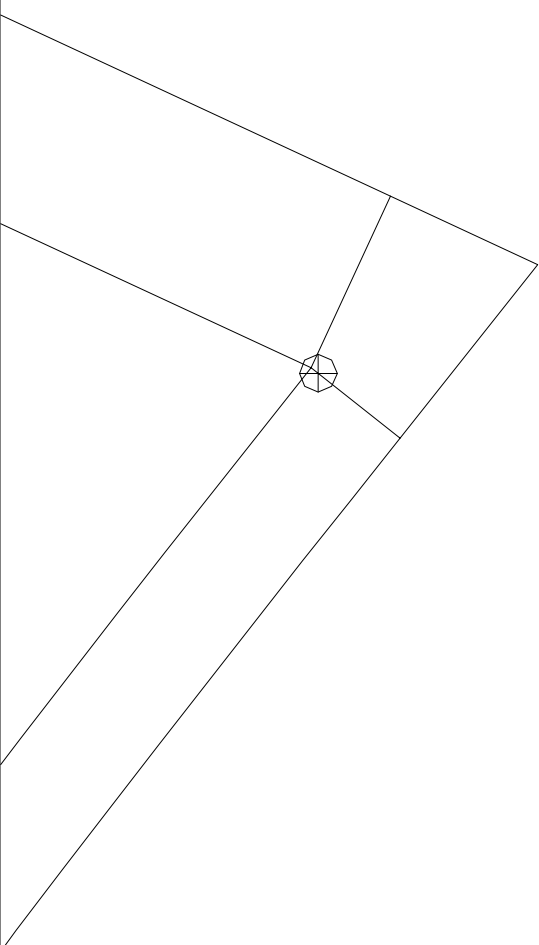

2-9

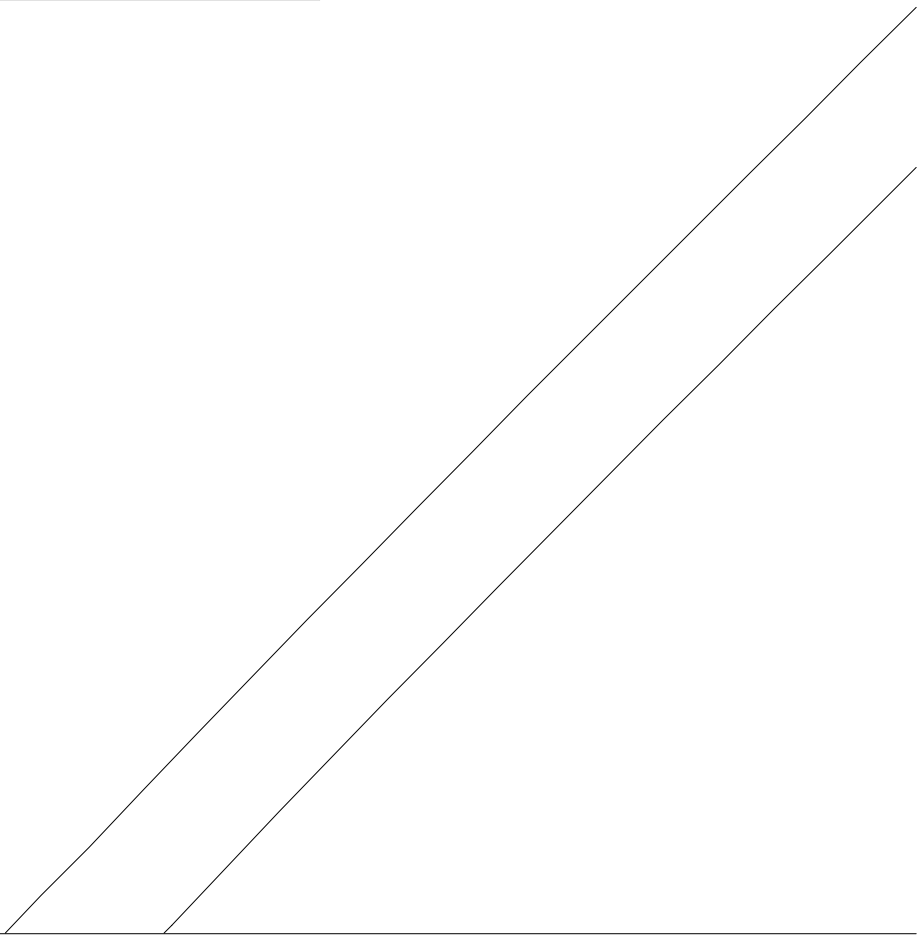

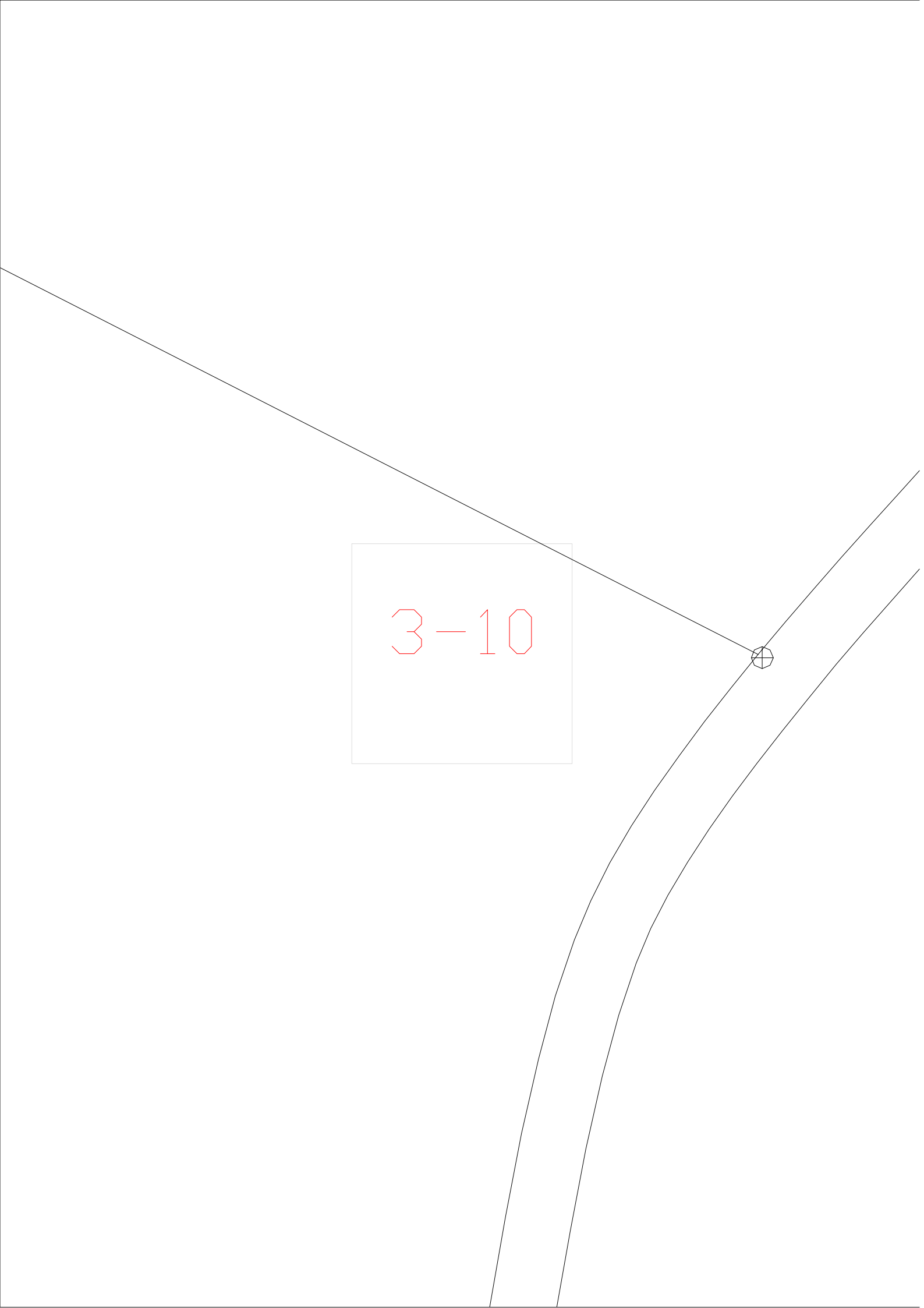

3-10

The image shows a technical drawing on a white background. A thin black line runs diagonally from the top-left towards the center-right. Another thin black line runs diagonally from the bottom-left towards the top-right, intersecting the first line. A small circle with a crosshair inside is located at the intersection point. Two curved lines, one above and one below the intersection, extend from the bottom-left towards the right. A light gray rectangular box is positioned to the left of the intersection, containing the red text '3-10'.

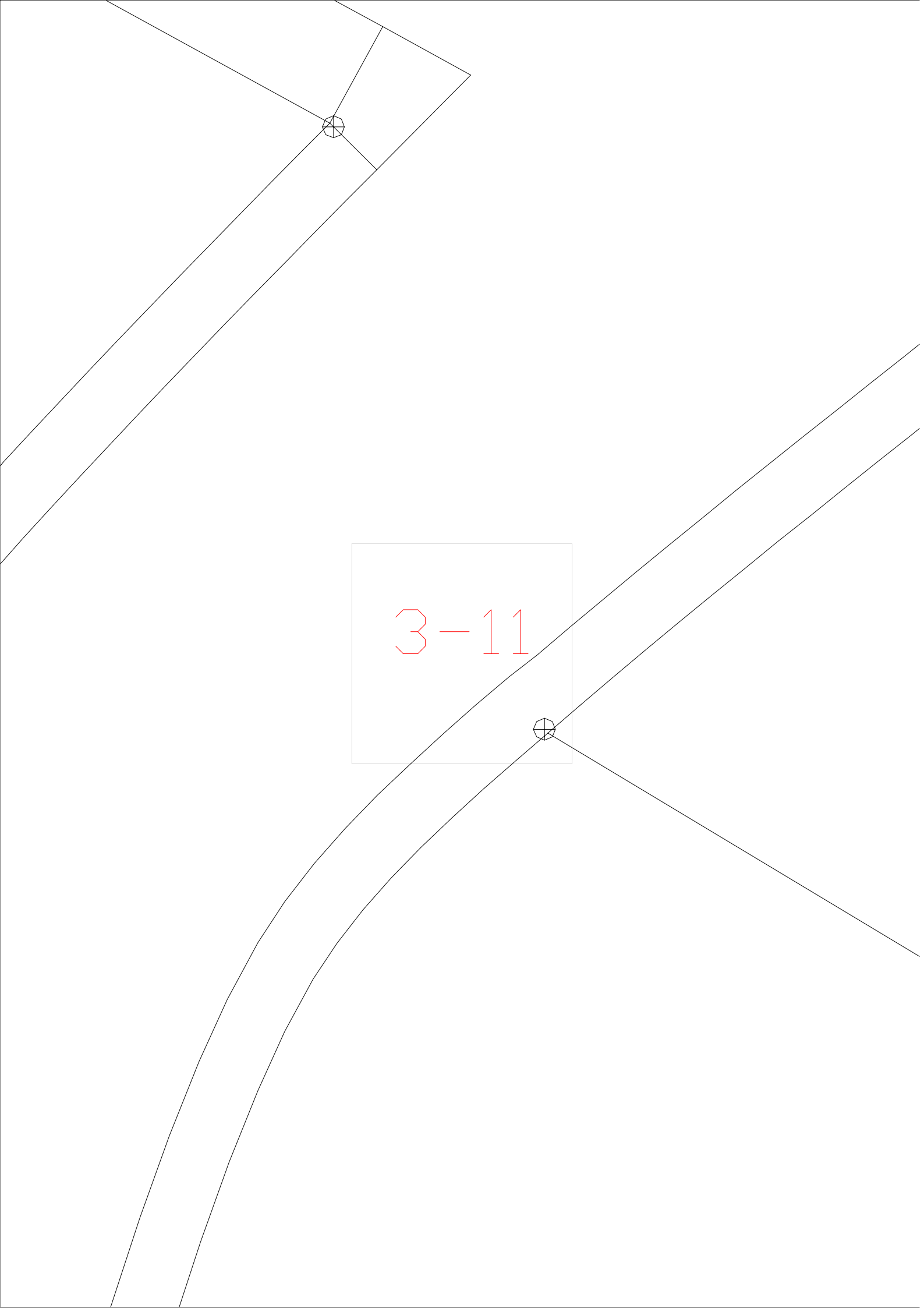

3-11

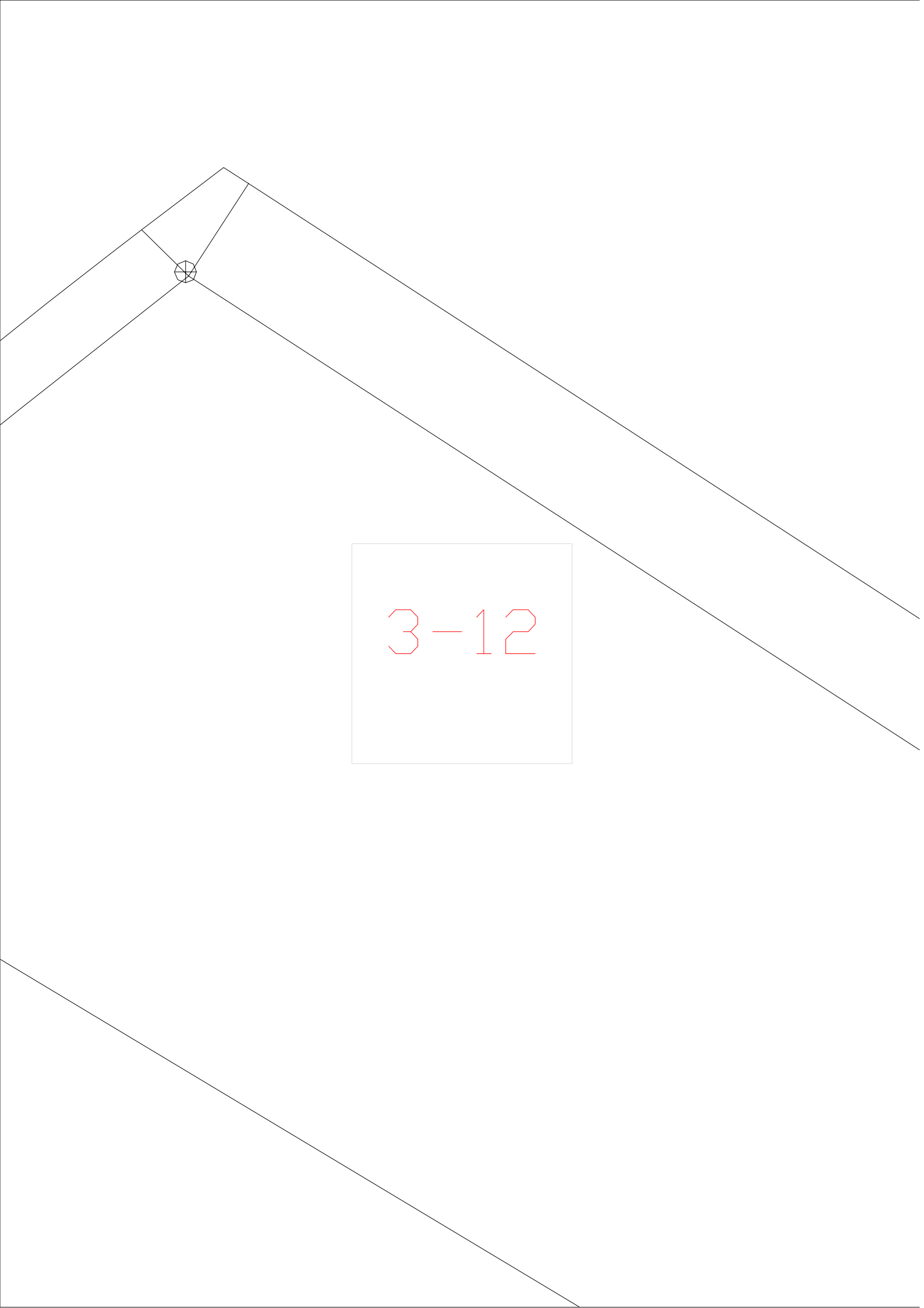

3-12

3-13

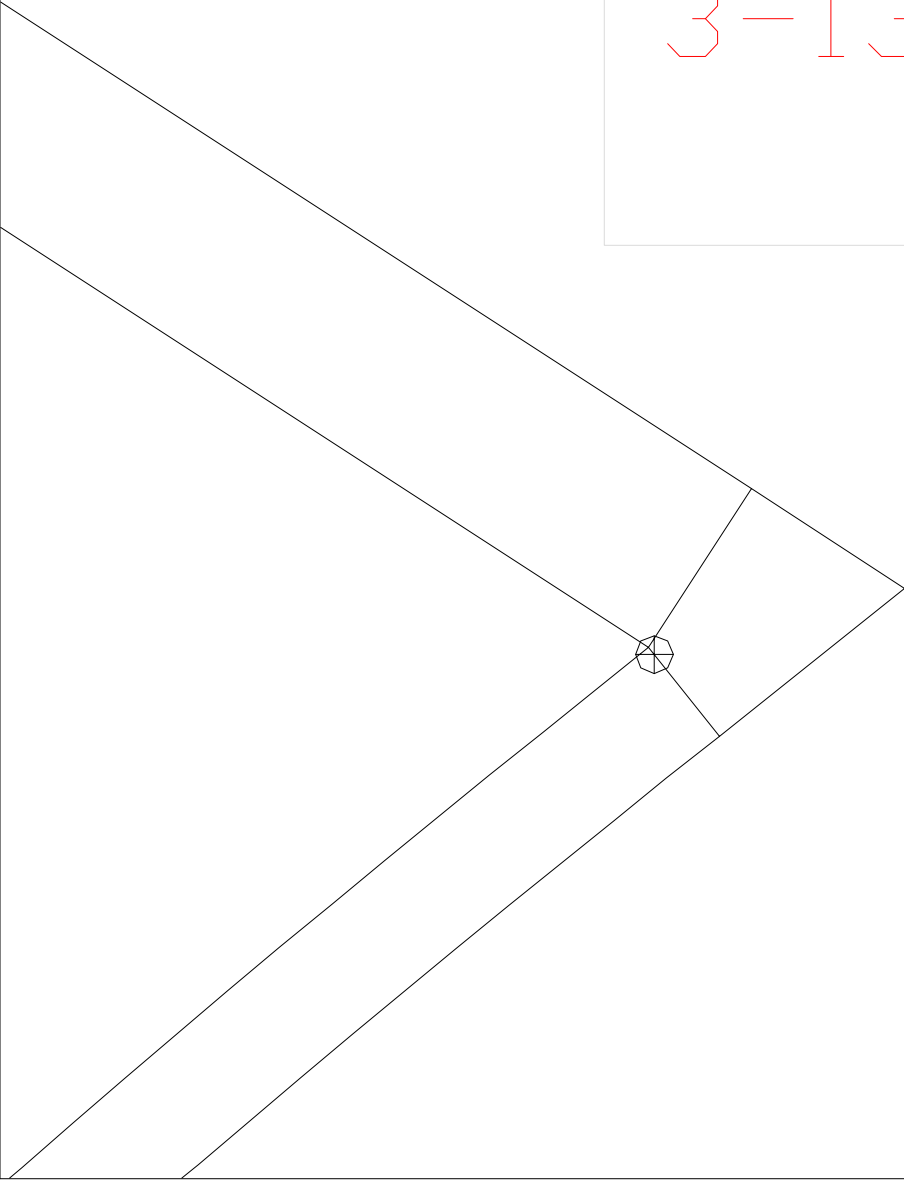

3-14

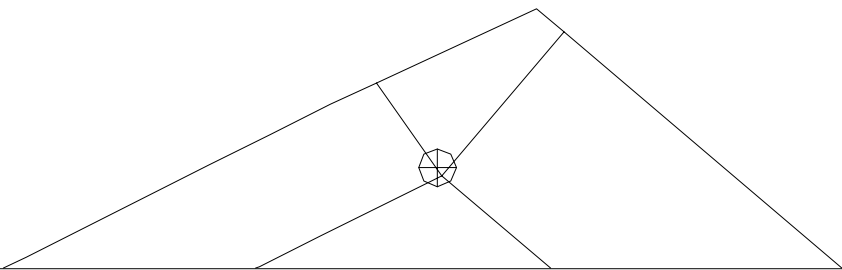

3-15

3-16



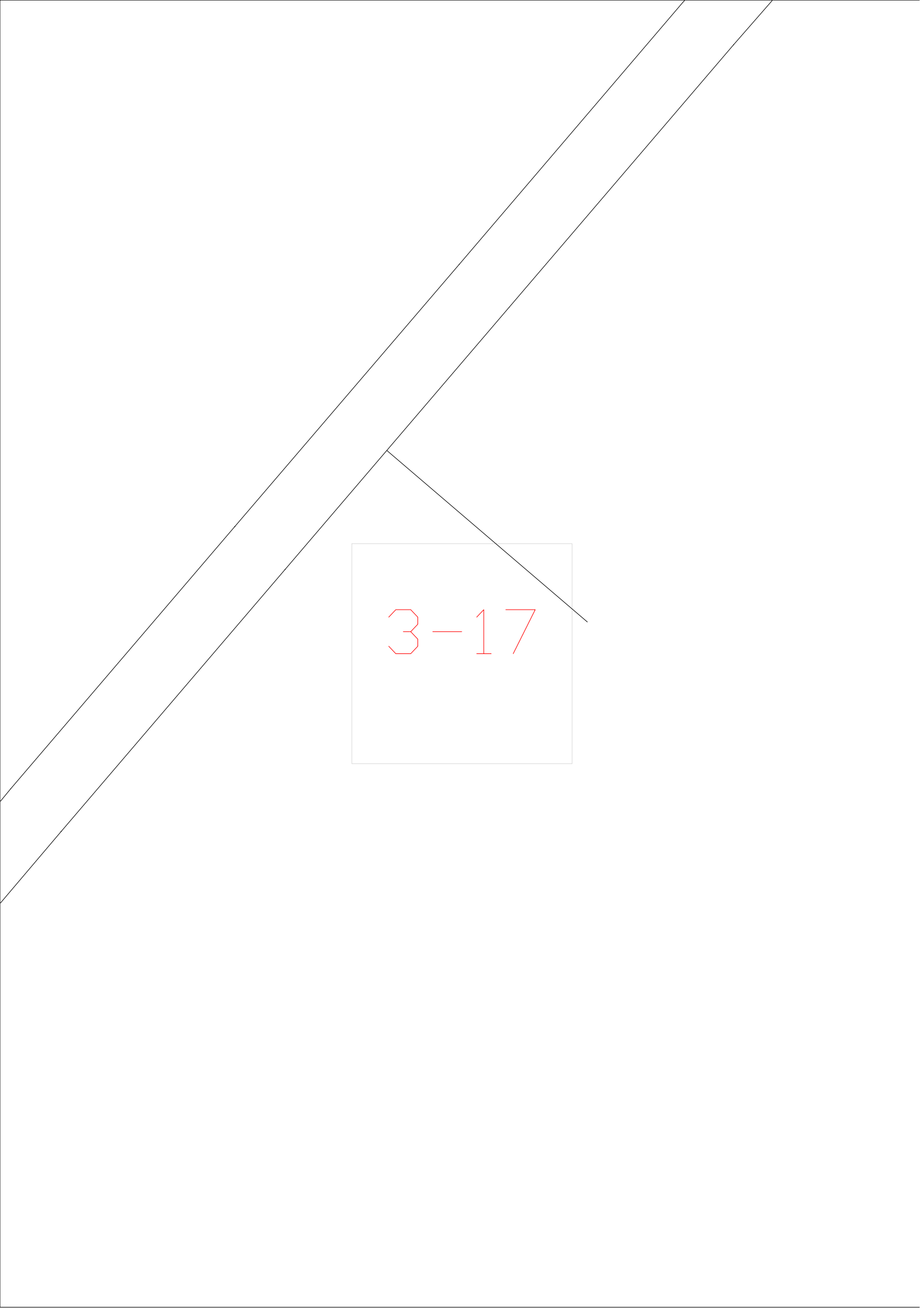

3-17

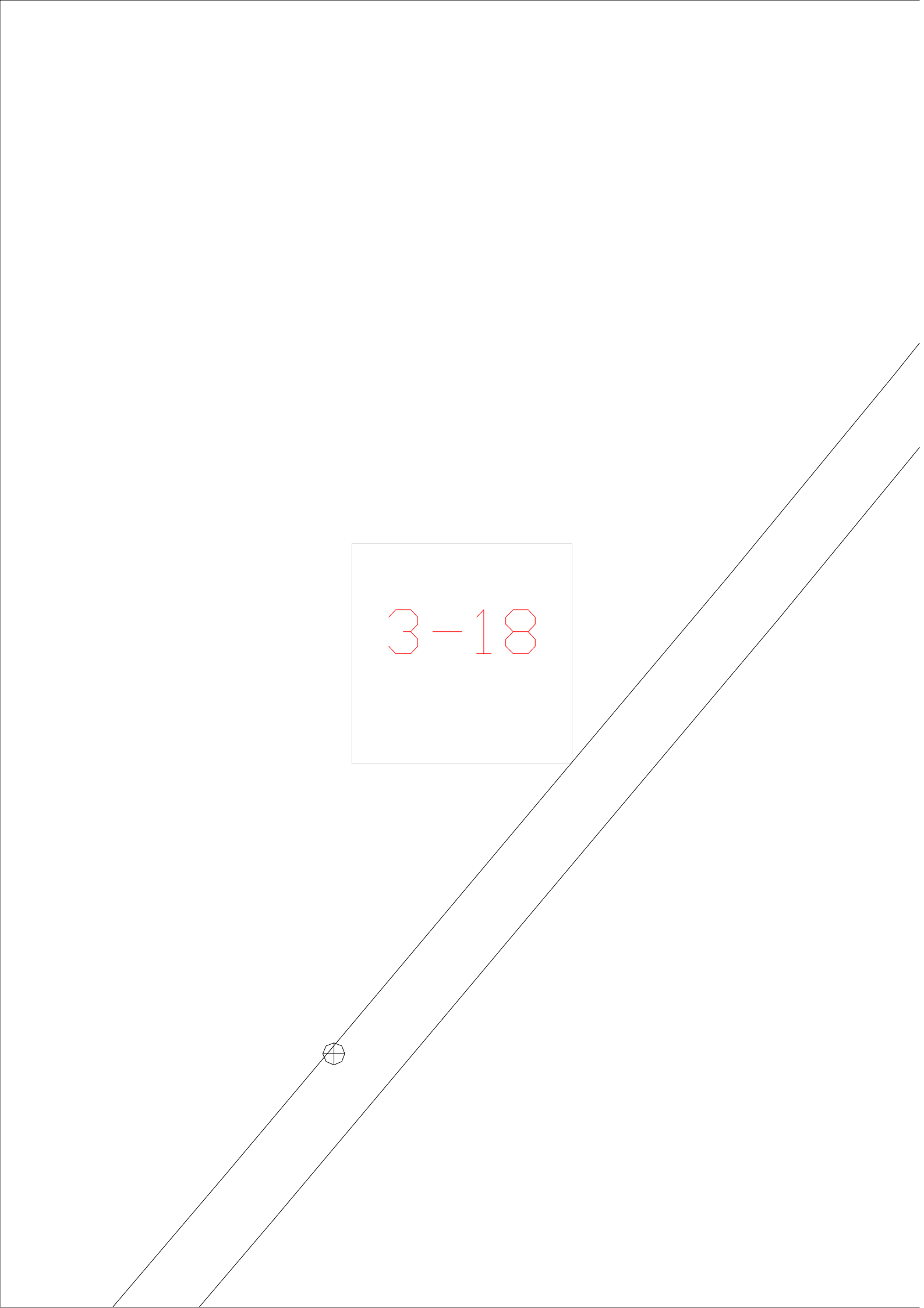

3-18



3-19



3-1



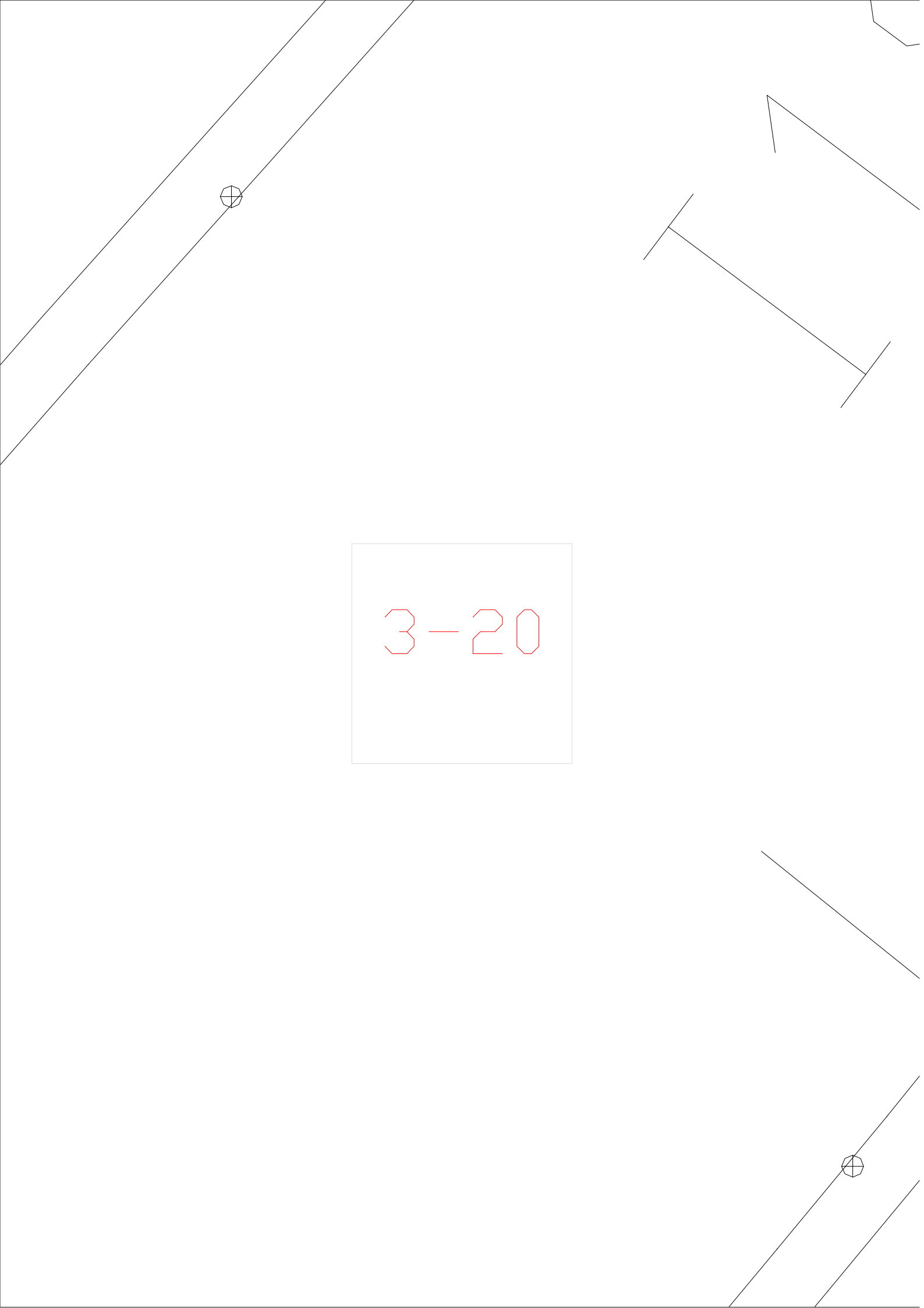

3-20

The image shows a technical drawing of a roof structure. It features a central rectangular box containing the text '3-20' in red. The drawing includes several lines representing the roof's geometry, with two circular symbols (one in the upper left and one in the lower right) indicating specific points or features. The overall layout is clean and technical in style.

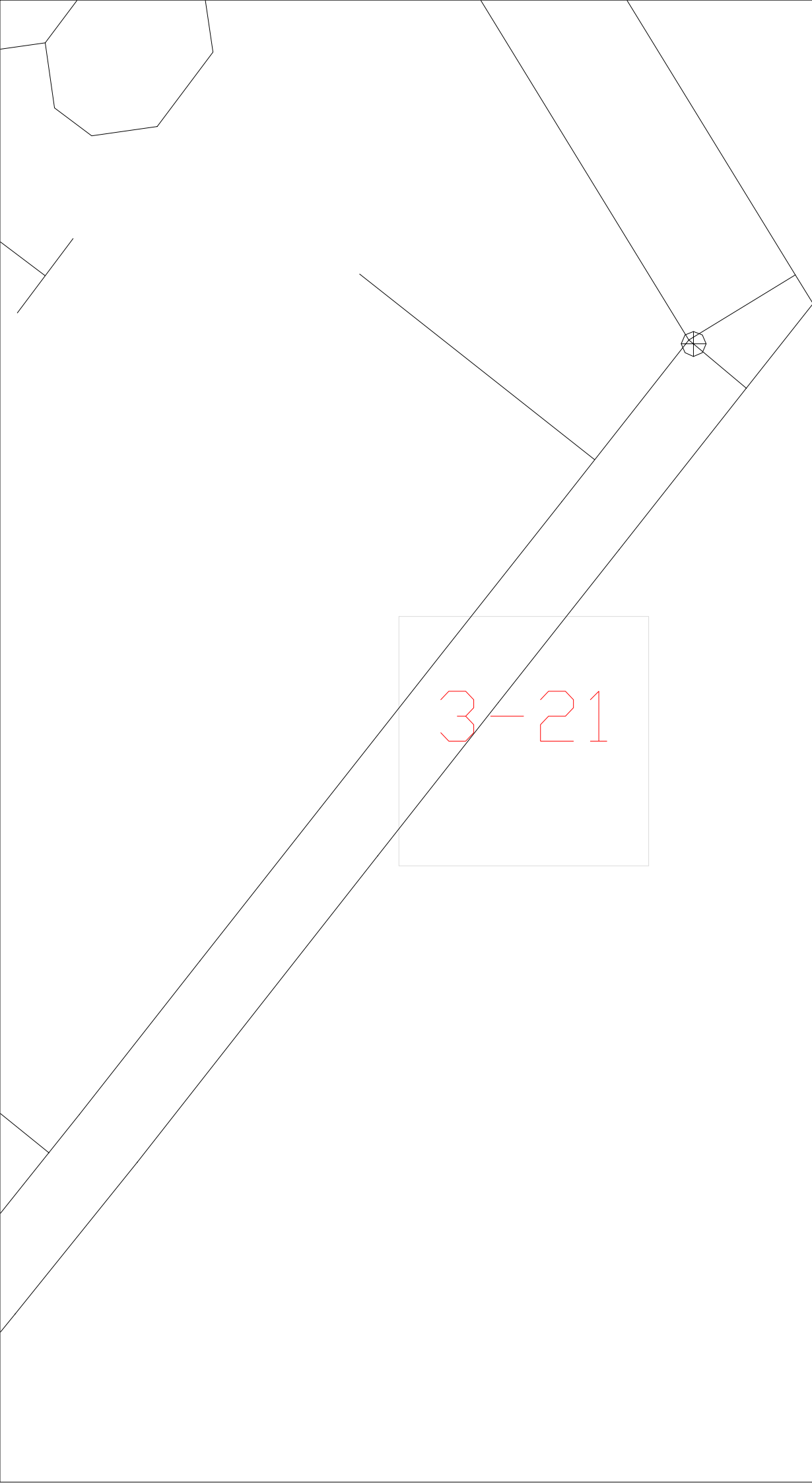

3-21

3-2

3-3



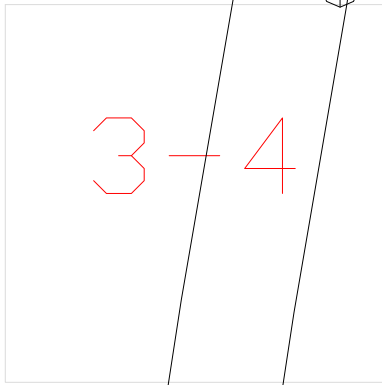

3-5



3-6



3-7

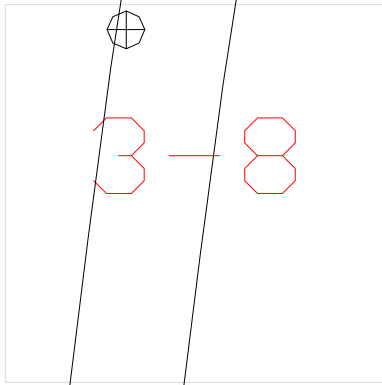

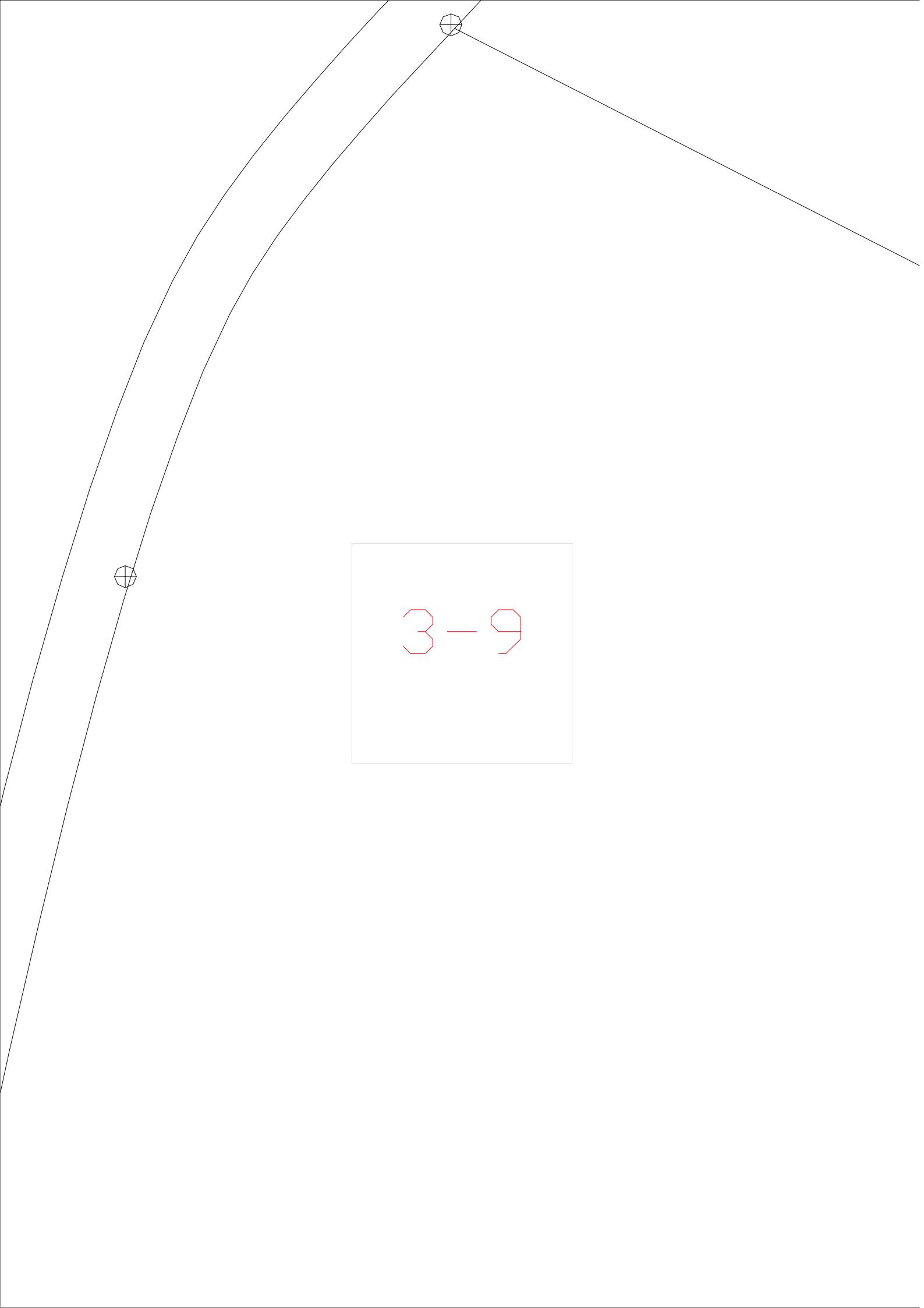

3-9



4-10

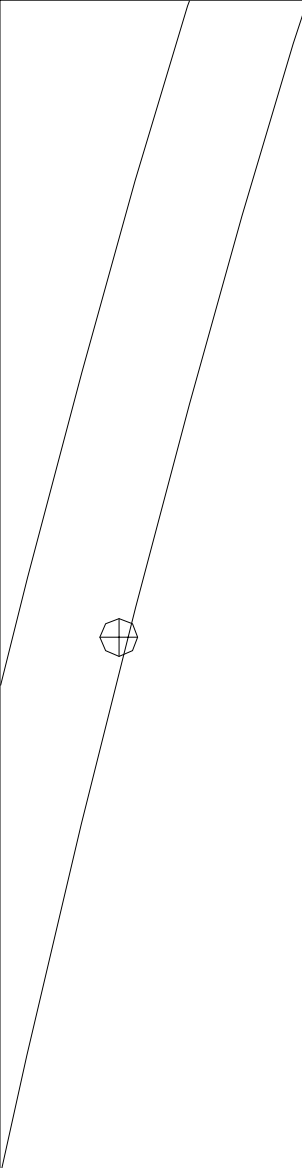

$$4 - 11$$

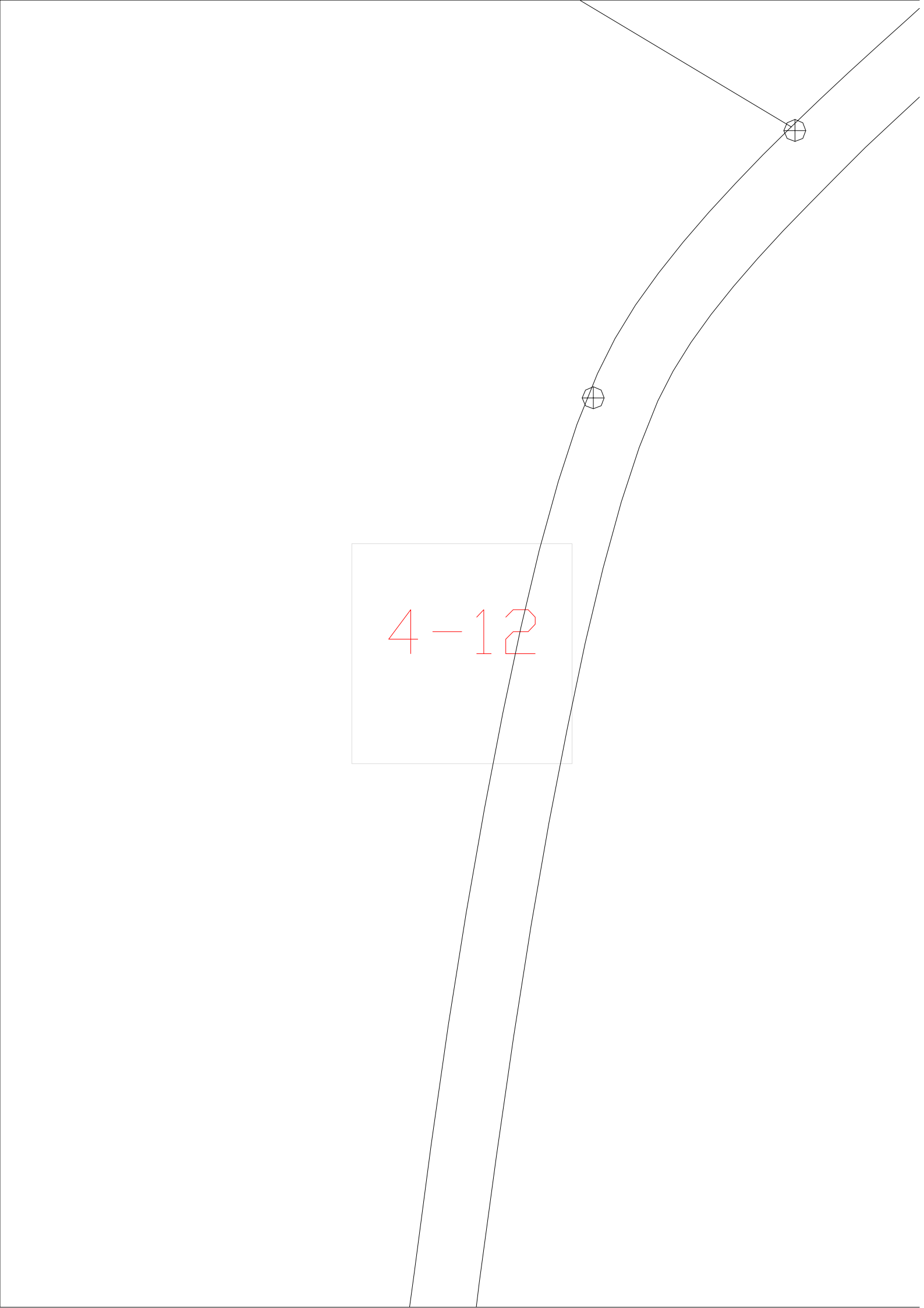

4-12

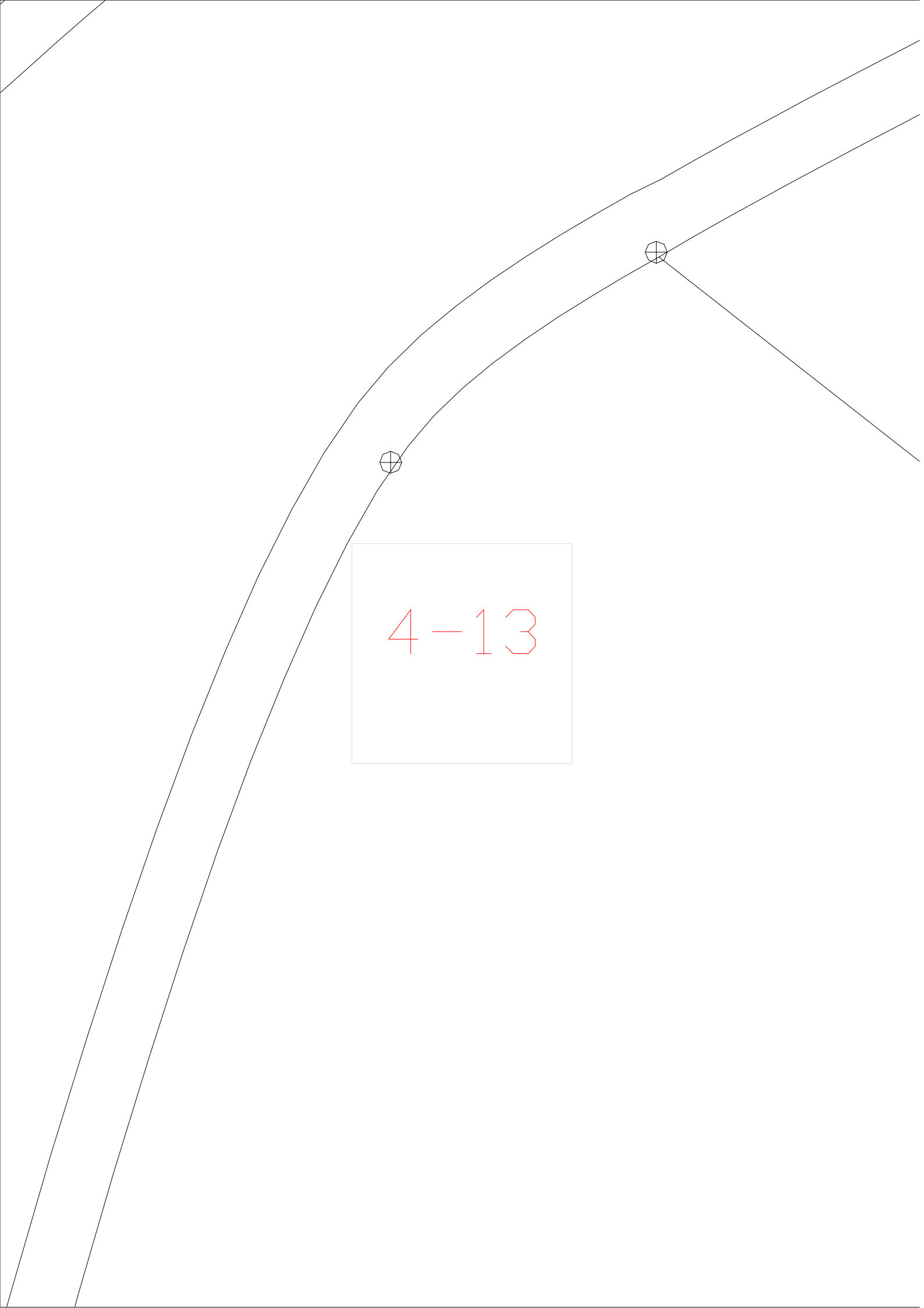

4-13

4-14



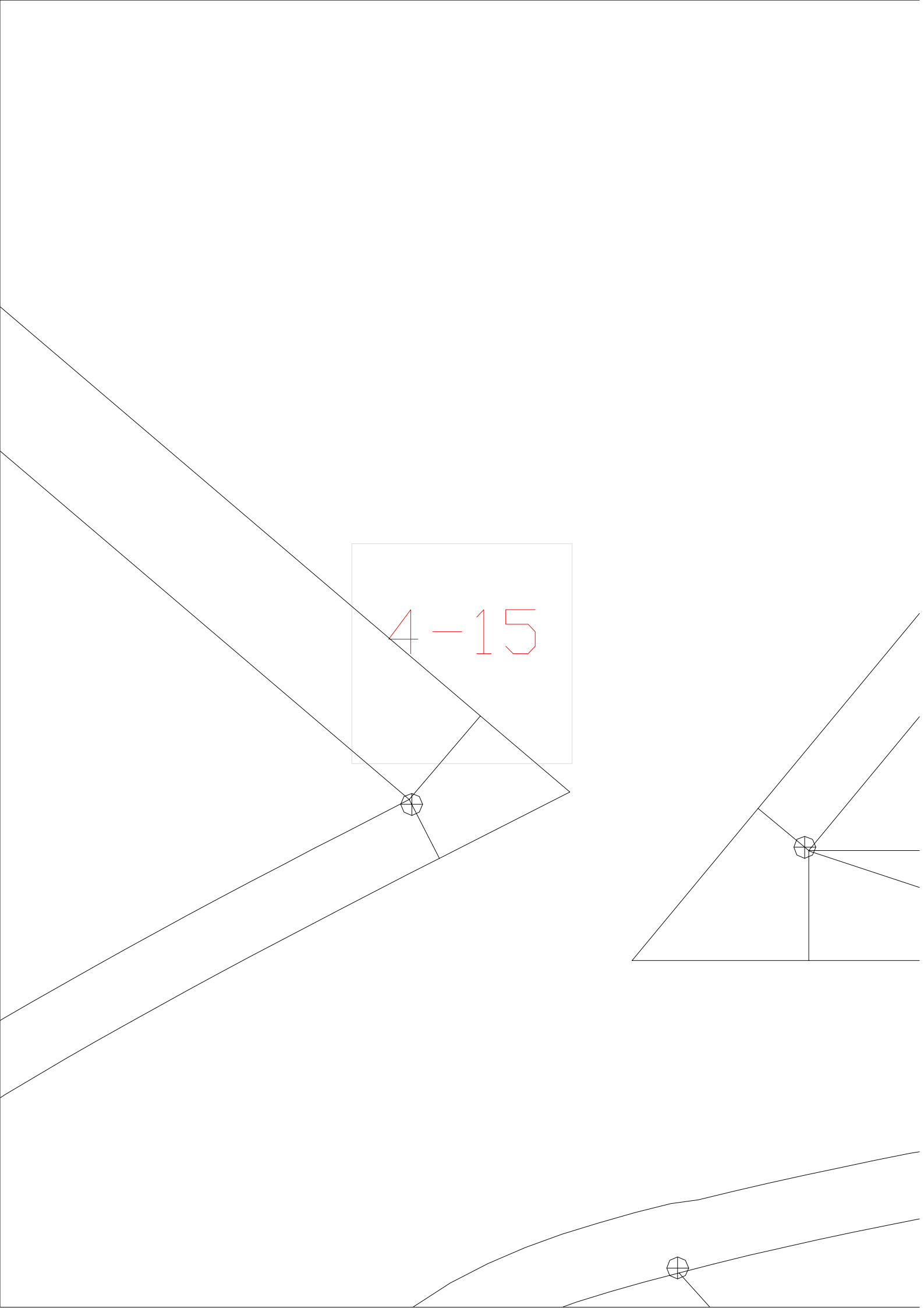

4-15

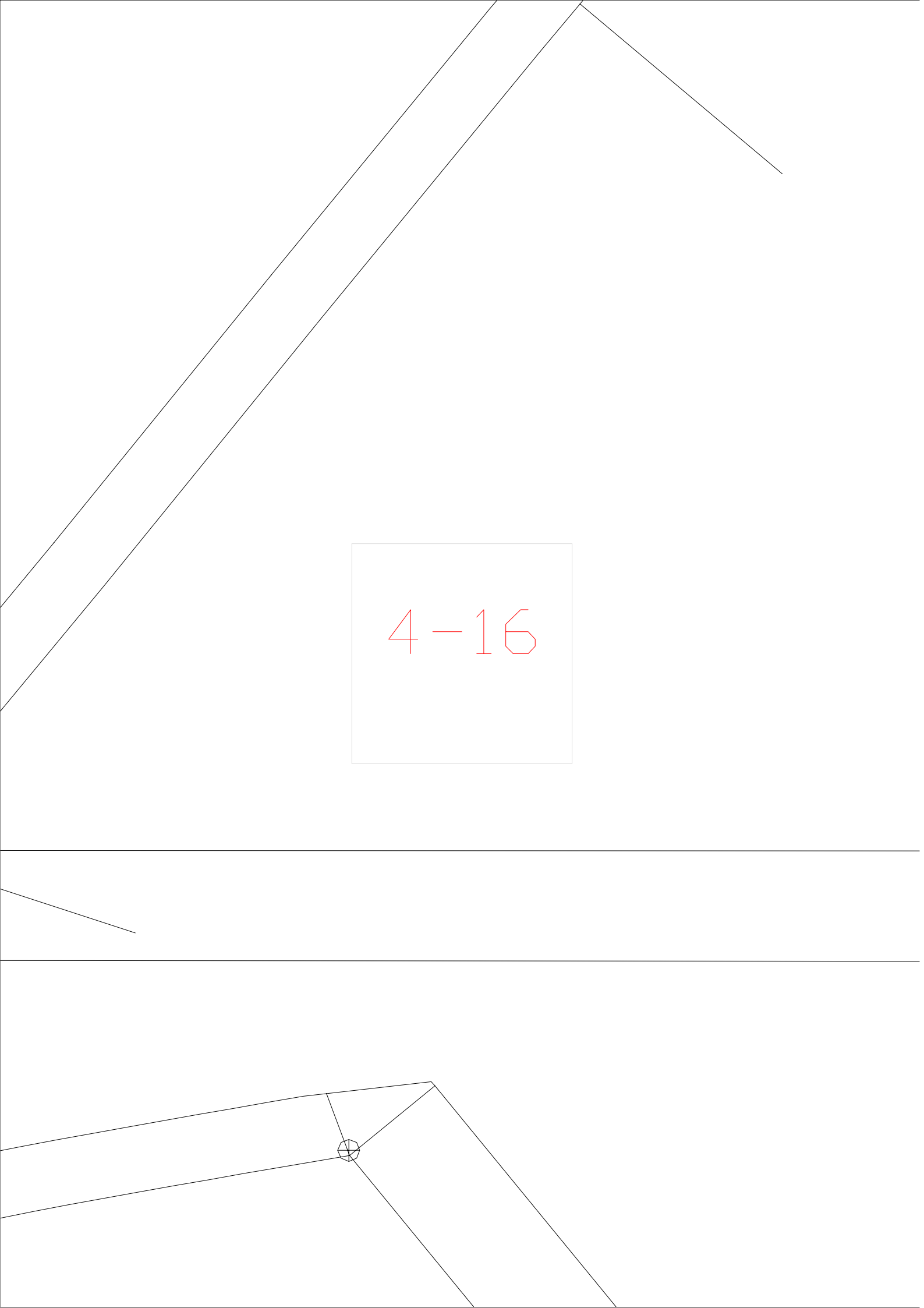

4-16

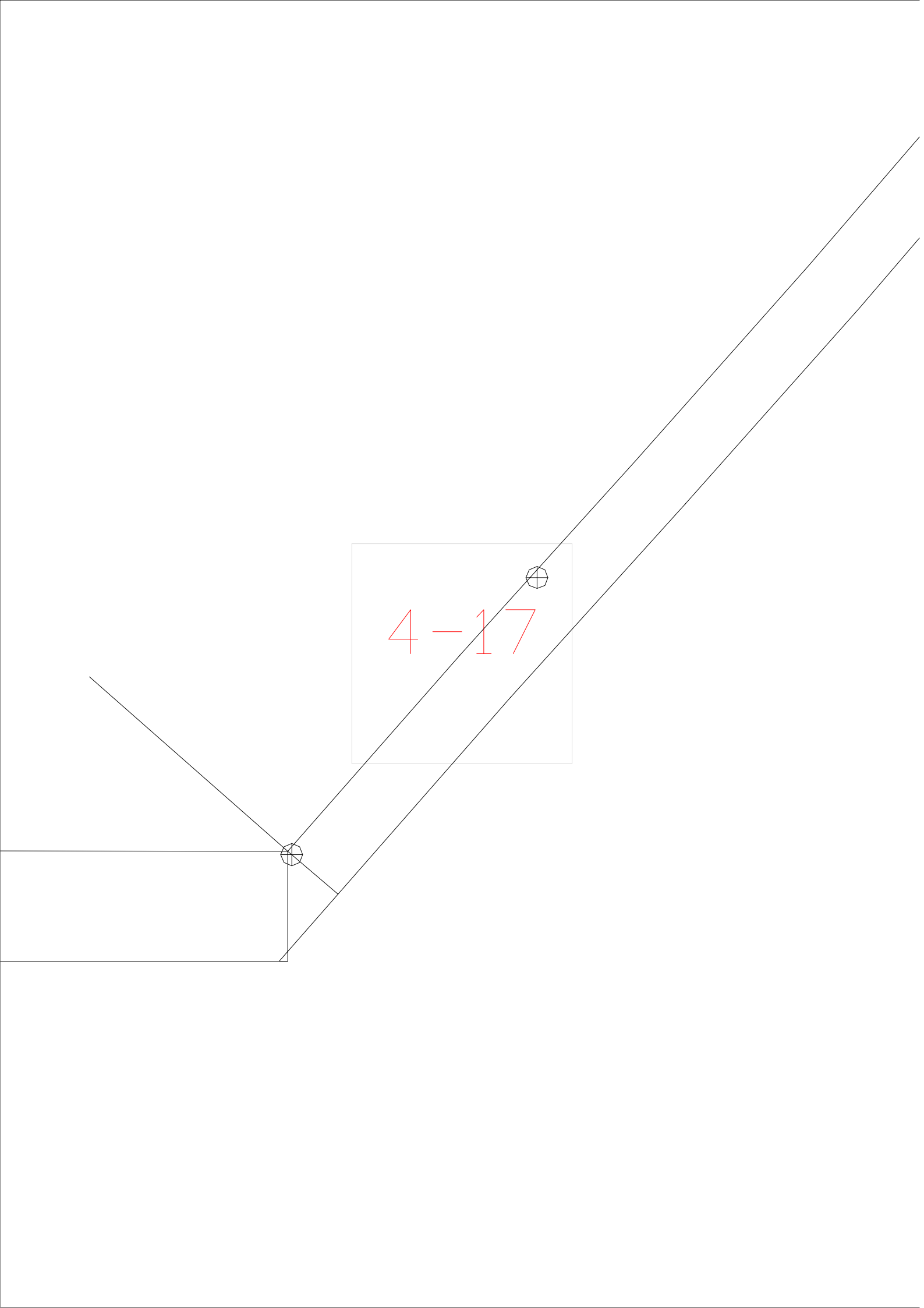

4-17

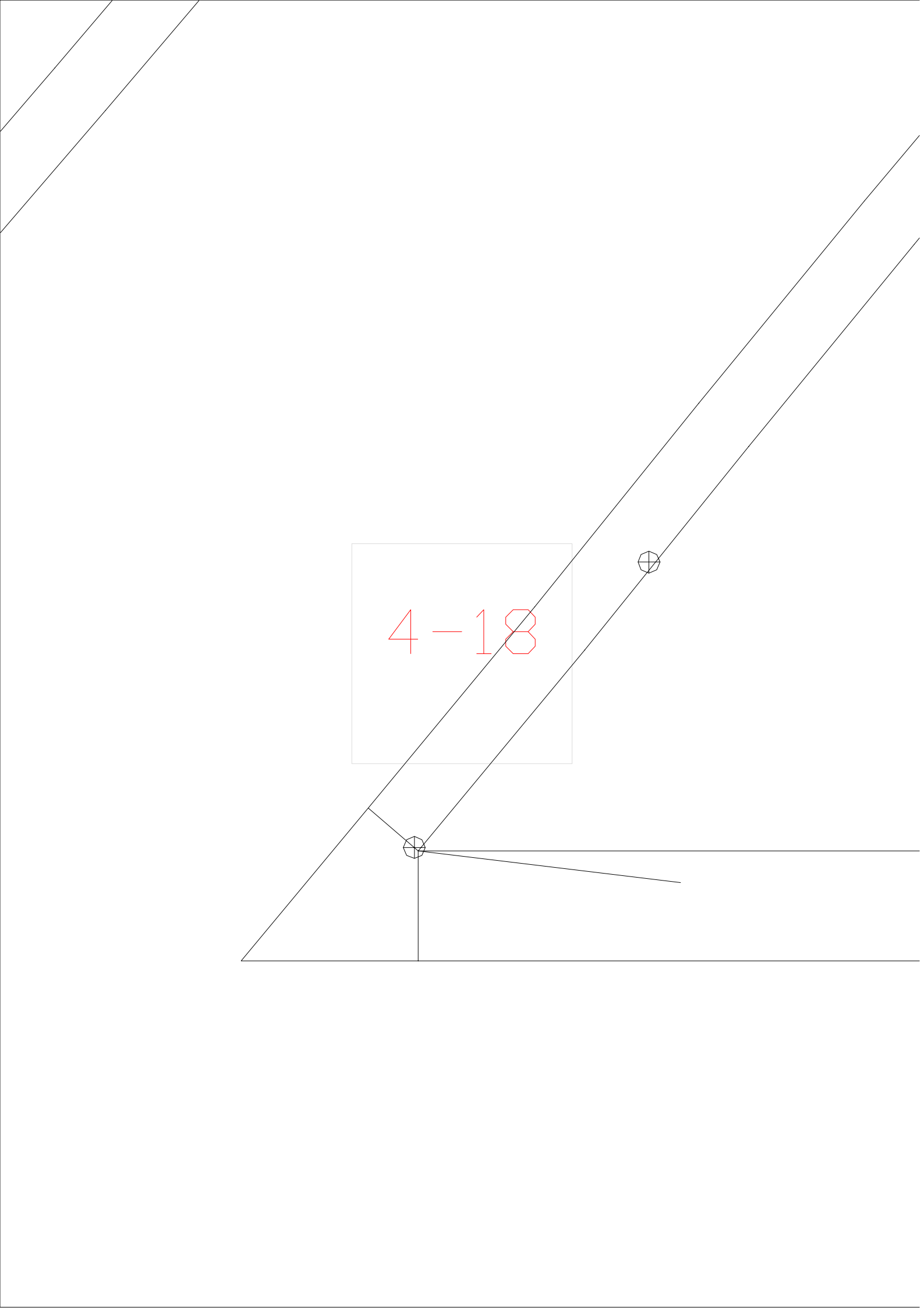

4-18

4-19

$$4 - 1$$



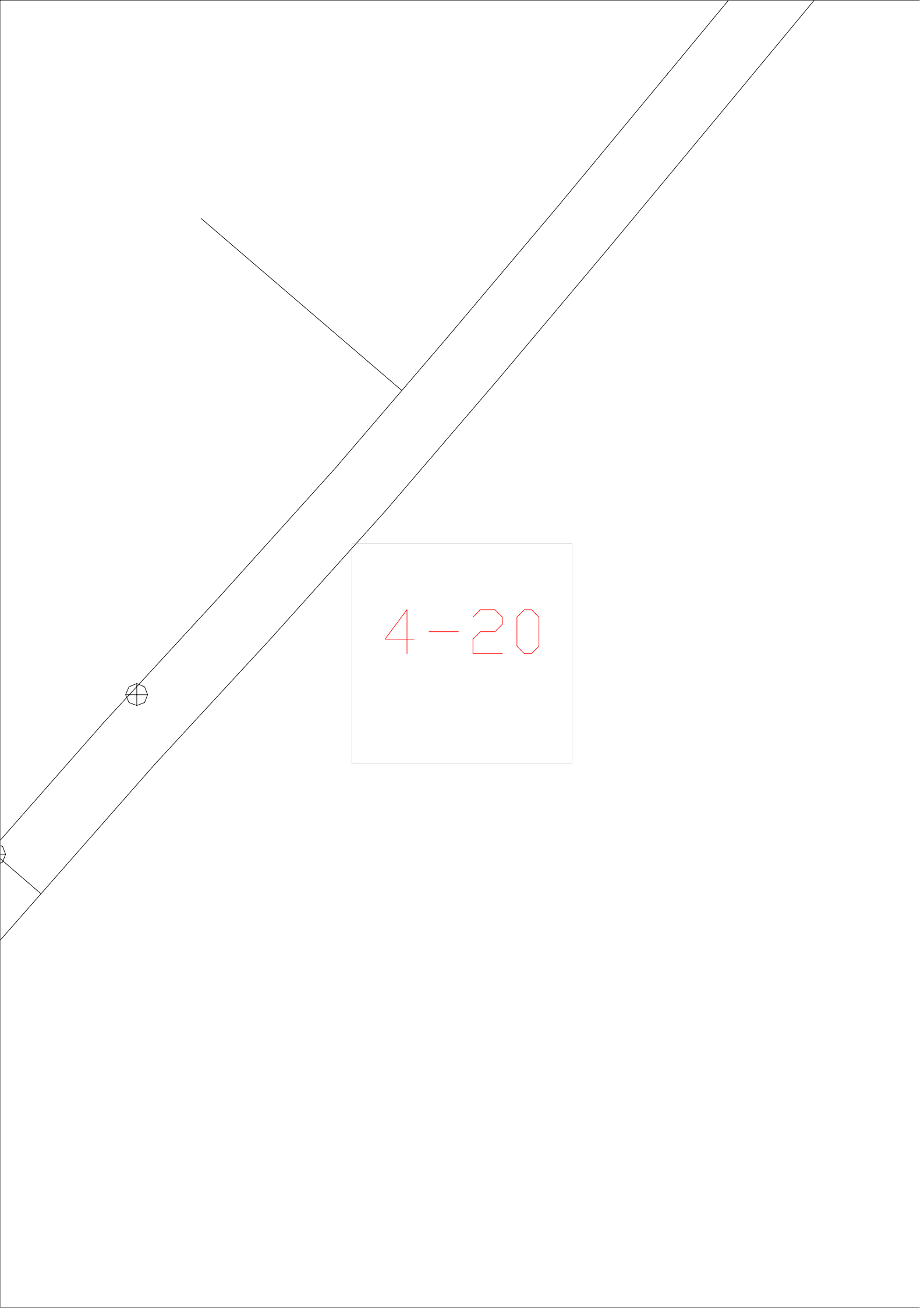

4-20

$$4 - 2$$



4 - 3



$$4 - 4$$

4-5



4 - 6

$$4 - 7$$



4 - 8

4-9

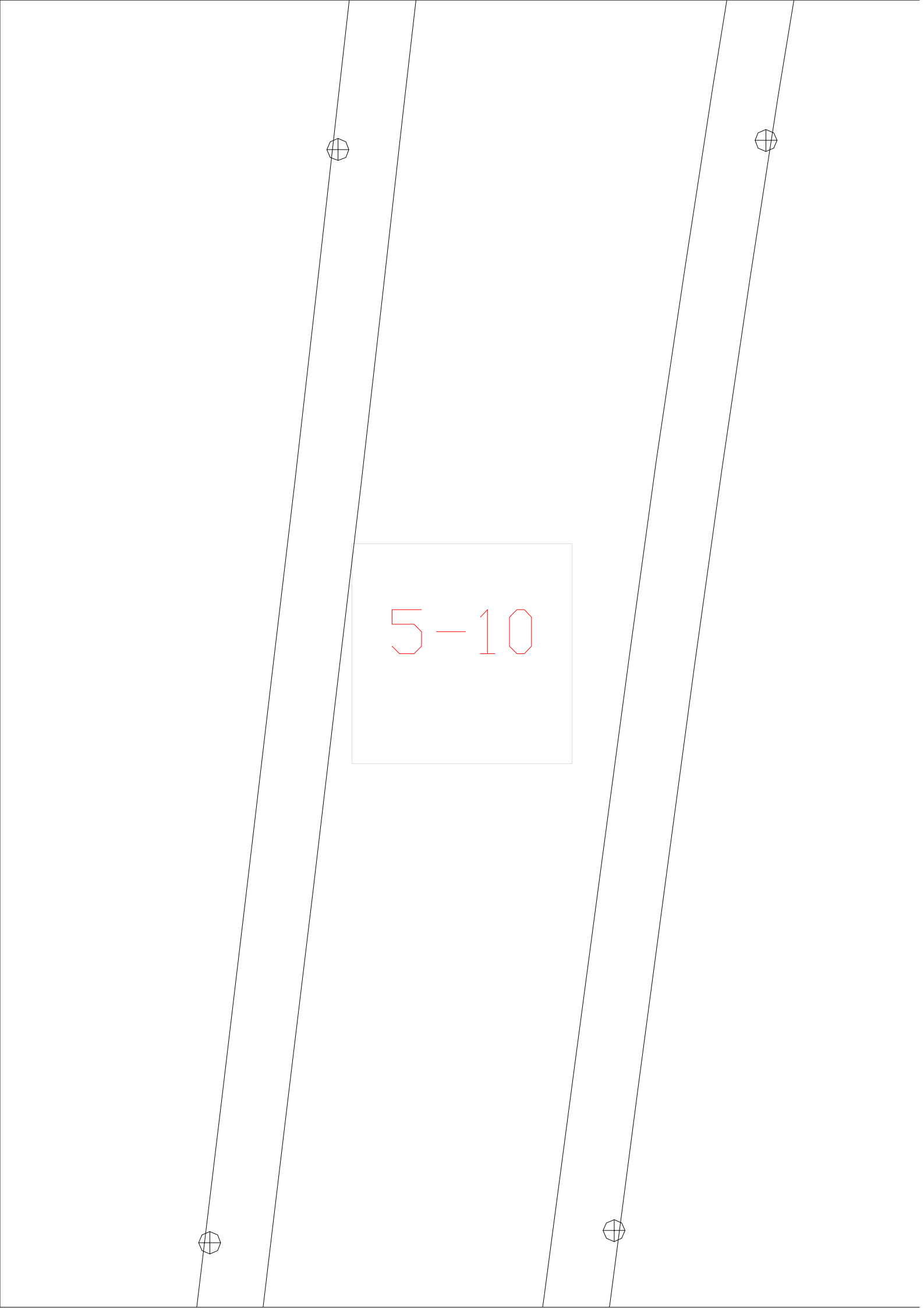

5-10

5-11

5-12



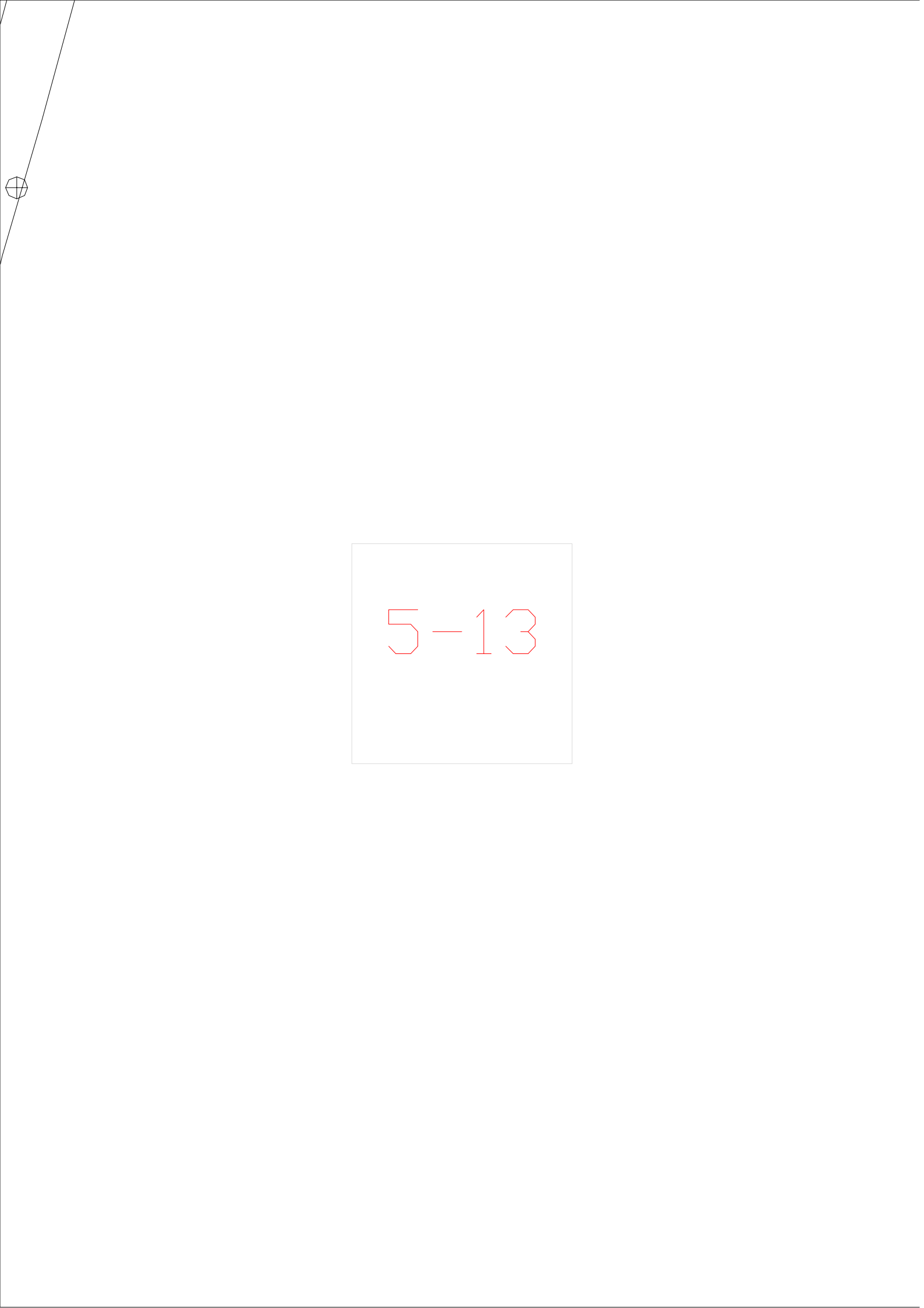

5-13

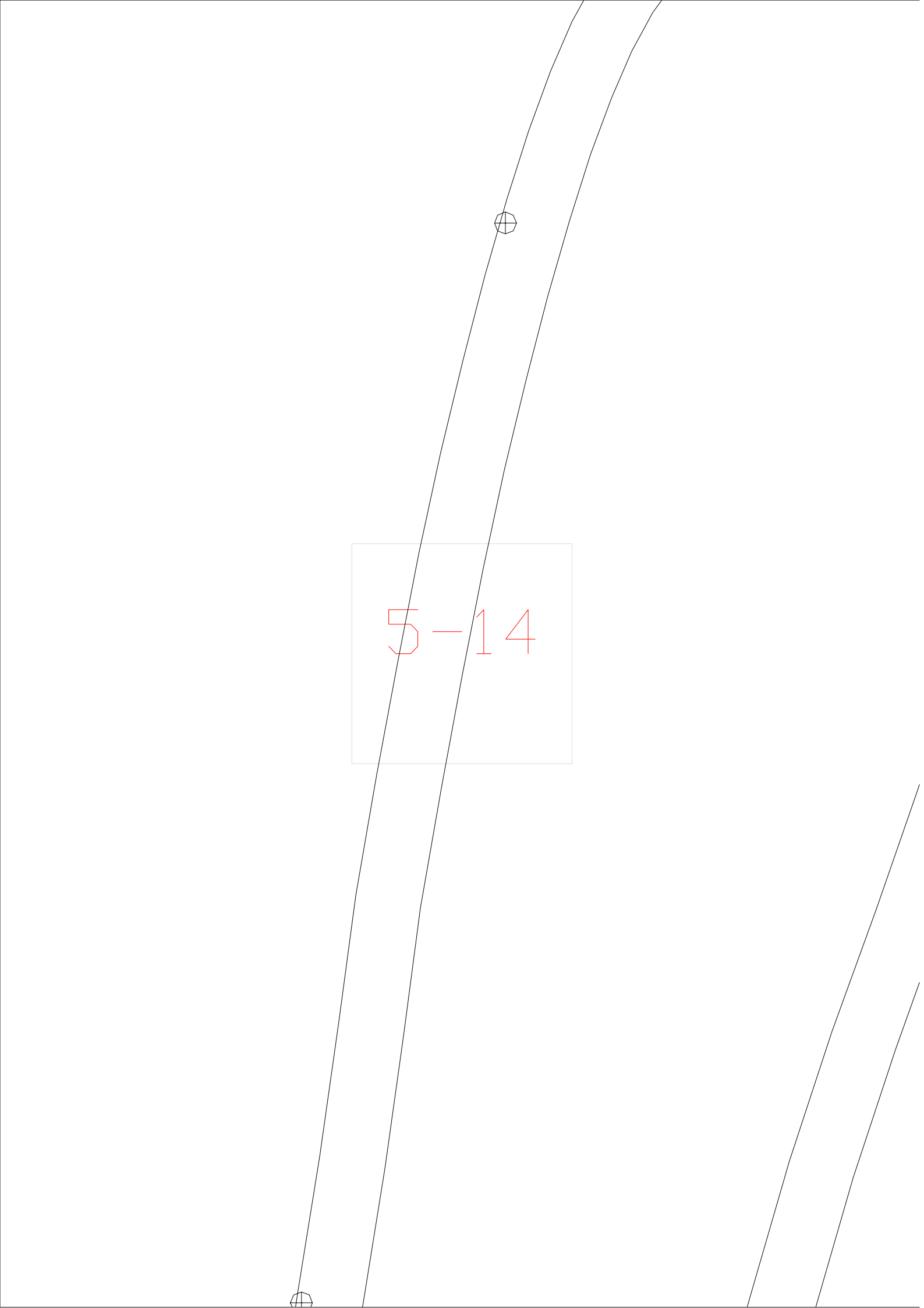

A diagram consisting of several curved lines that sweep upwards from the bottom towards the top. Two circular markers, each divided into four quadrants, are placed on the lines: one at the bottom left and one higher up on the left side. A central rectangular box contains the text '5-14' in red.

5-14

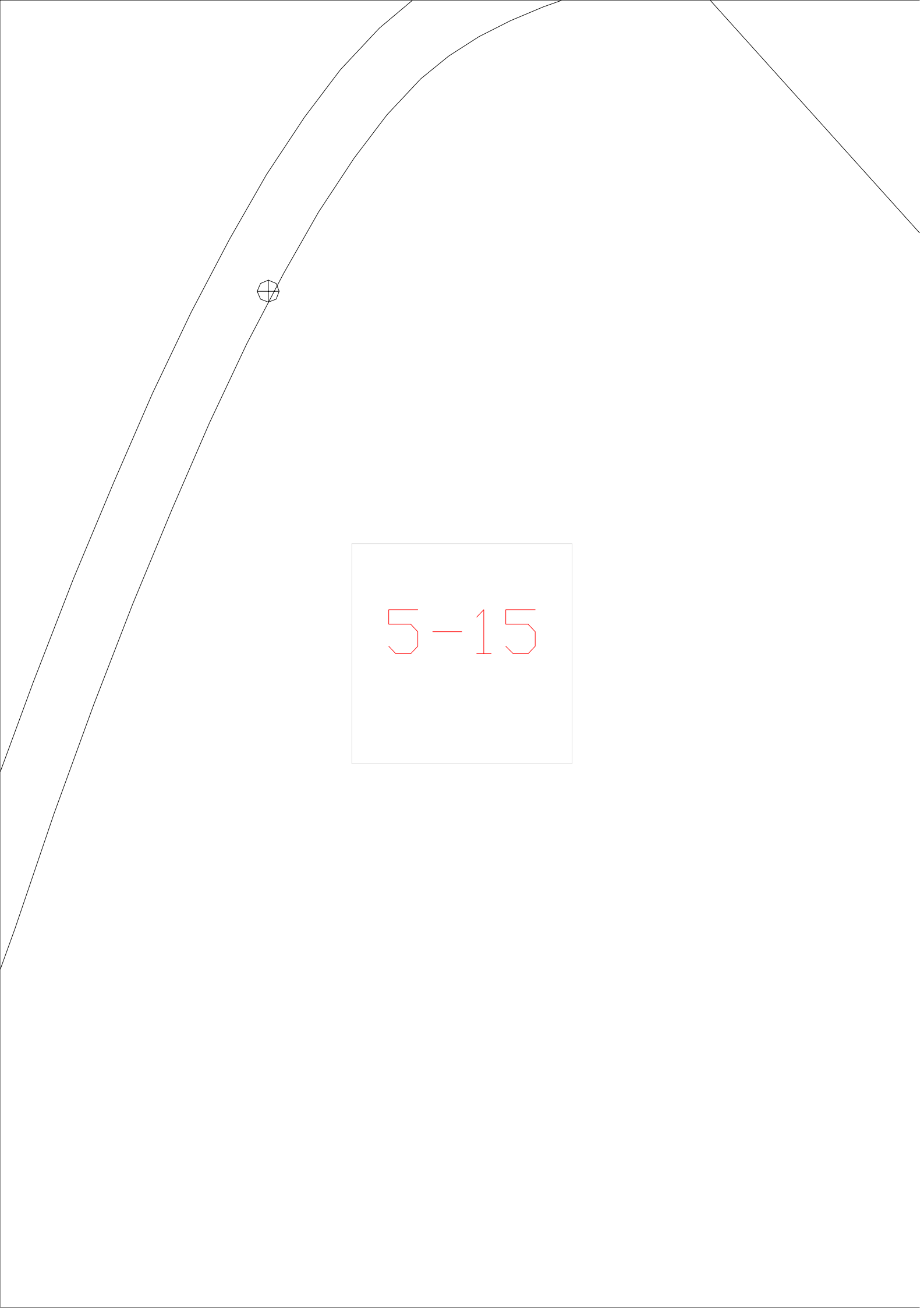

5-15

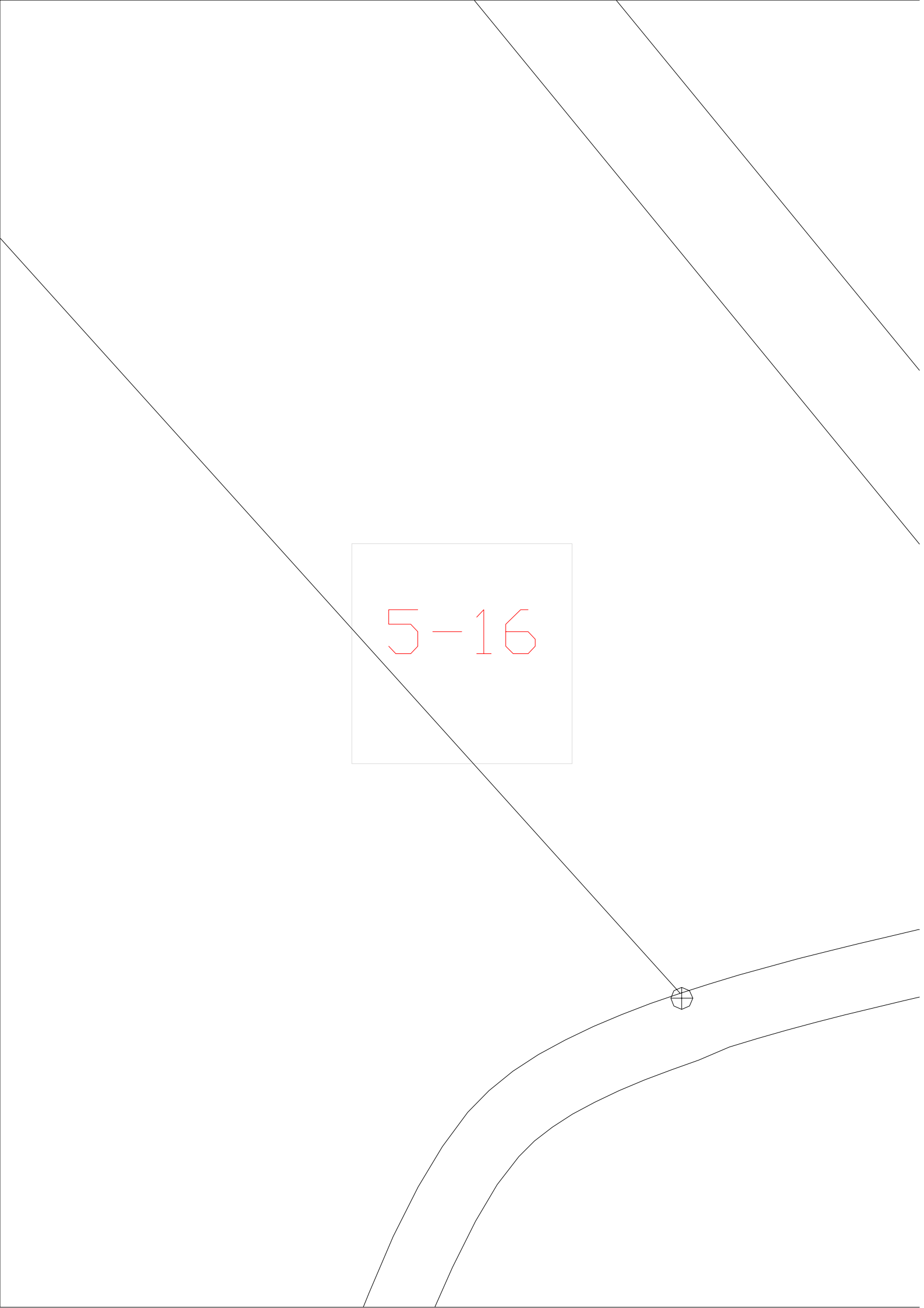

5-16

The image is a technical drawing on a white background. It features several black lines: a vertical line on the left, a horizontal line at the bottom, and two parallel diagonal lines sloping downwards from left to right. A rectangular box with a thin black border is centered in the upper-middle part of the drawing, containing the red text '5-16'. In the lower-right quadrant, there is a small circle with a crosshair inside, which is positioned at the intersection of the two parallel diagonal lines and a curved line that starts from the bottom edge and curves upwards and to the right.

5-17

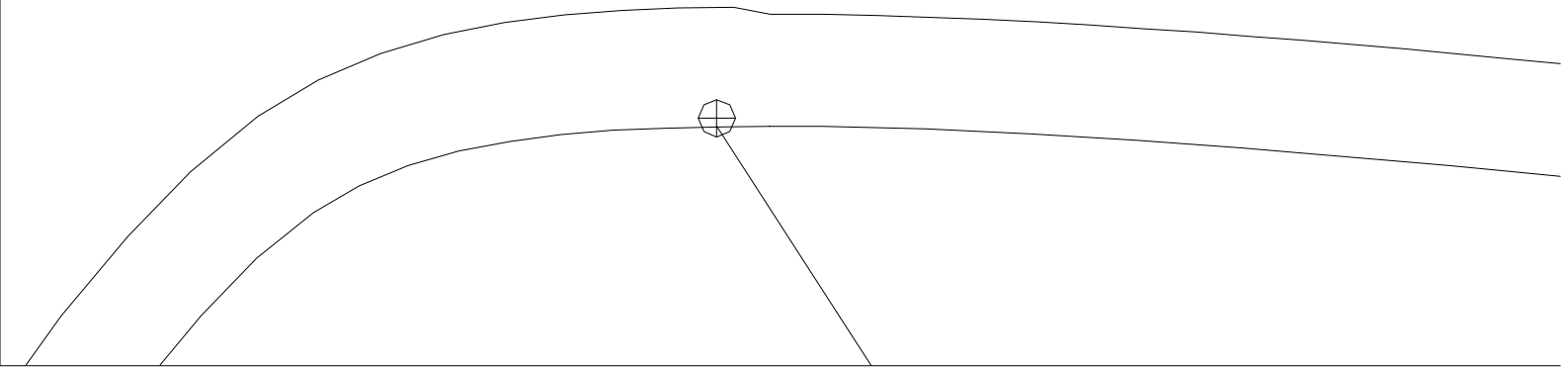
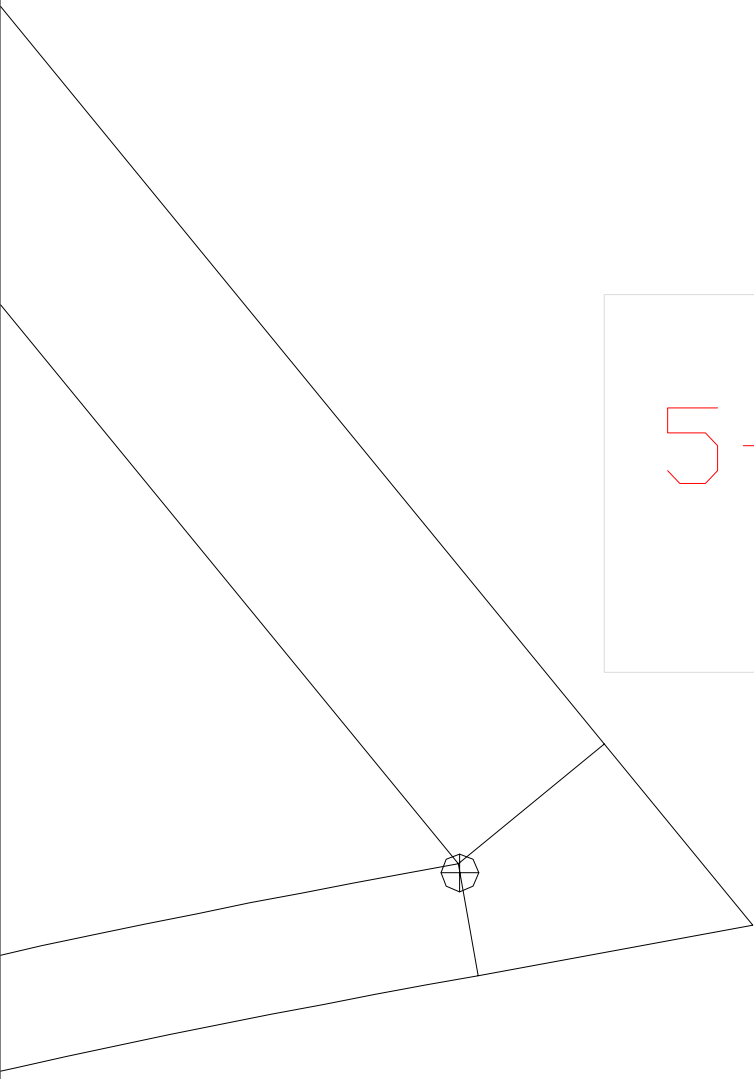

5-18

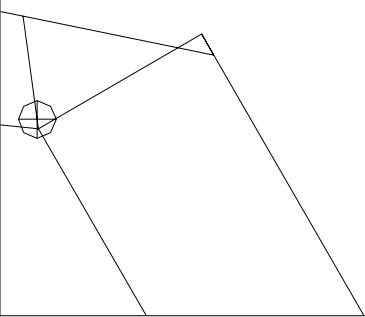

5-19

5-1



5-20

5-21

5-2



5-3



5-4

5-5



5-6

5-7



5-8

5-9

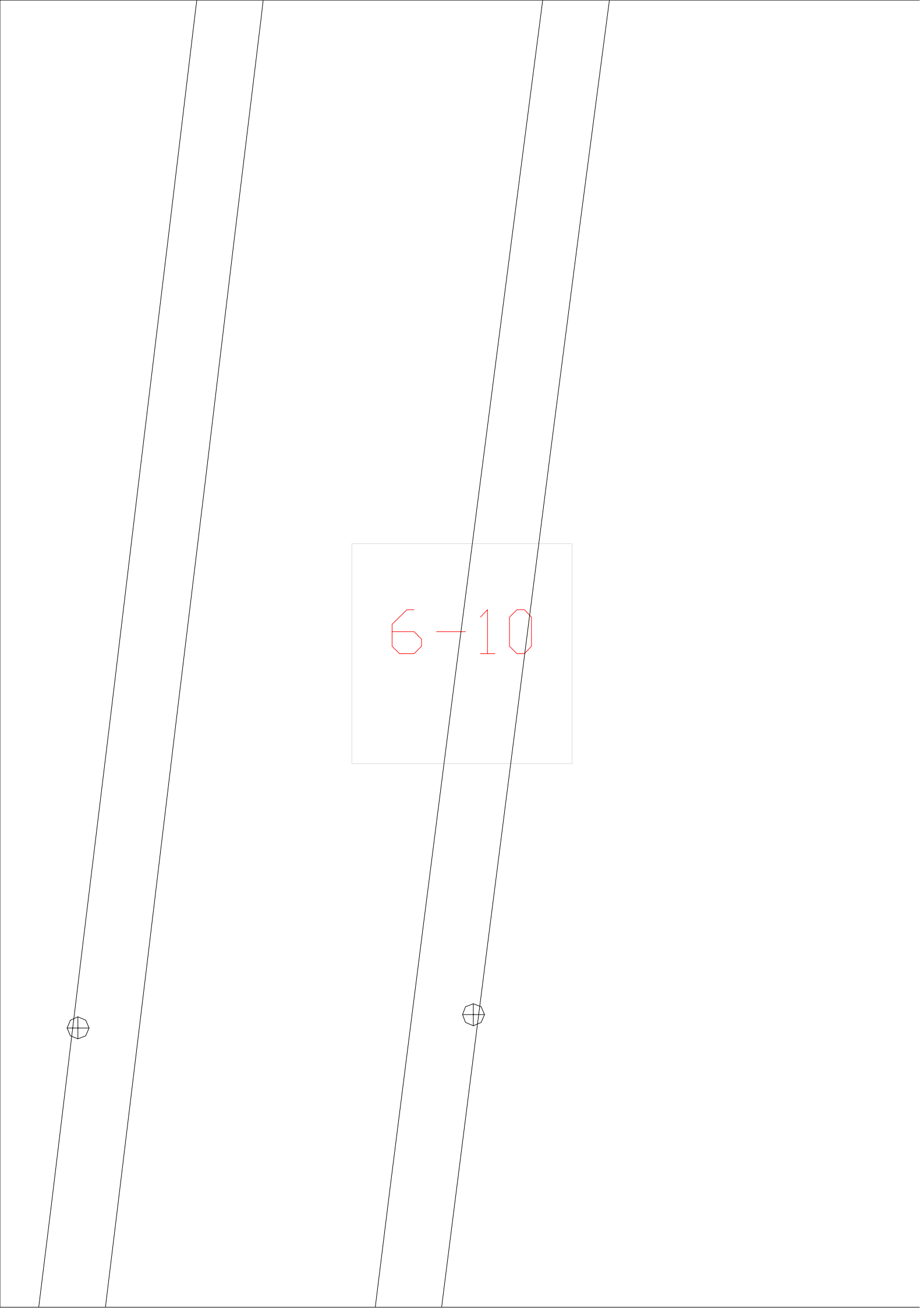

6-10

The image shows a technical drawing of a shaft with a hole. The shaft is represented by two parallel lines that are slightly tapered. A hole is shown as a circle with a cross inside, located on the shaft. The drawing is centered on a white background. A light gray rectangular box is drawn around the text '6-10', which is written in red. The text is positioned in the middle of the shaft's length. The shaft is oriented vertically, and the hole is located on the left side of the shaft. The drawing is a simple line drawing with no shading or color, except for the red text.

6-11

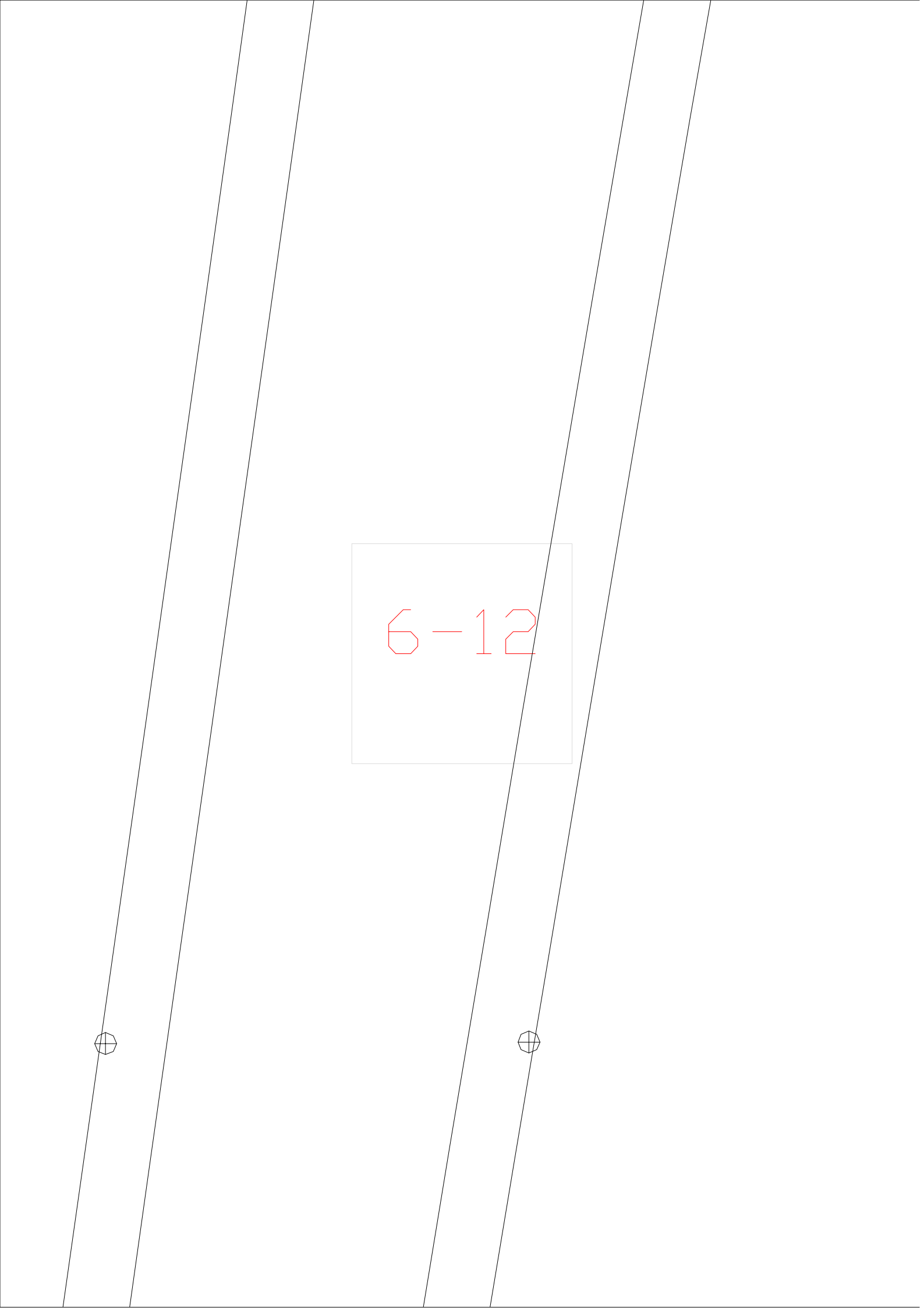

6-12

The image shows a technical drawing of a tapered shaft. The shaft is represented by two parallel lines that converge towards the top, indicating a taper. The shaft is oriented vertically. In the center of the shaft, there is a rectangular box containing the text '6-12' in red. At the bottom of the shaft, there are two circular features, each with a crosshair inside, representing mounting holes or fasteners. The drawing is a simple line drawing with no shading or texture.

6-13

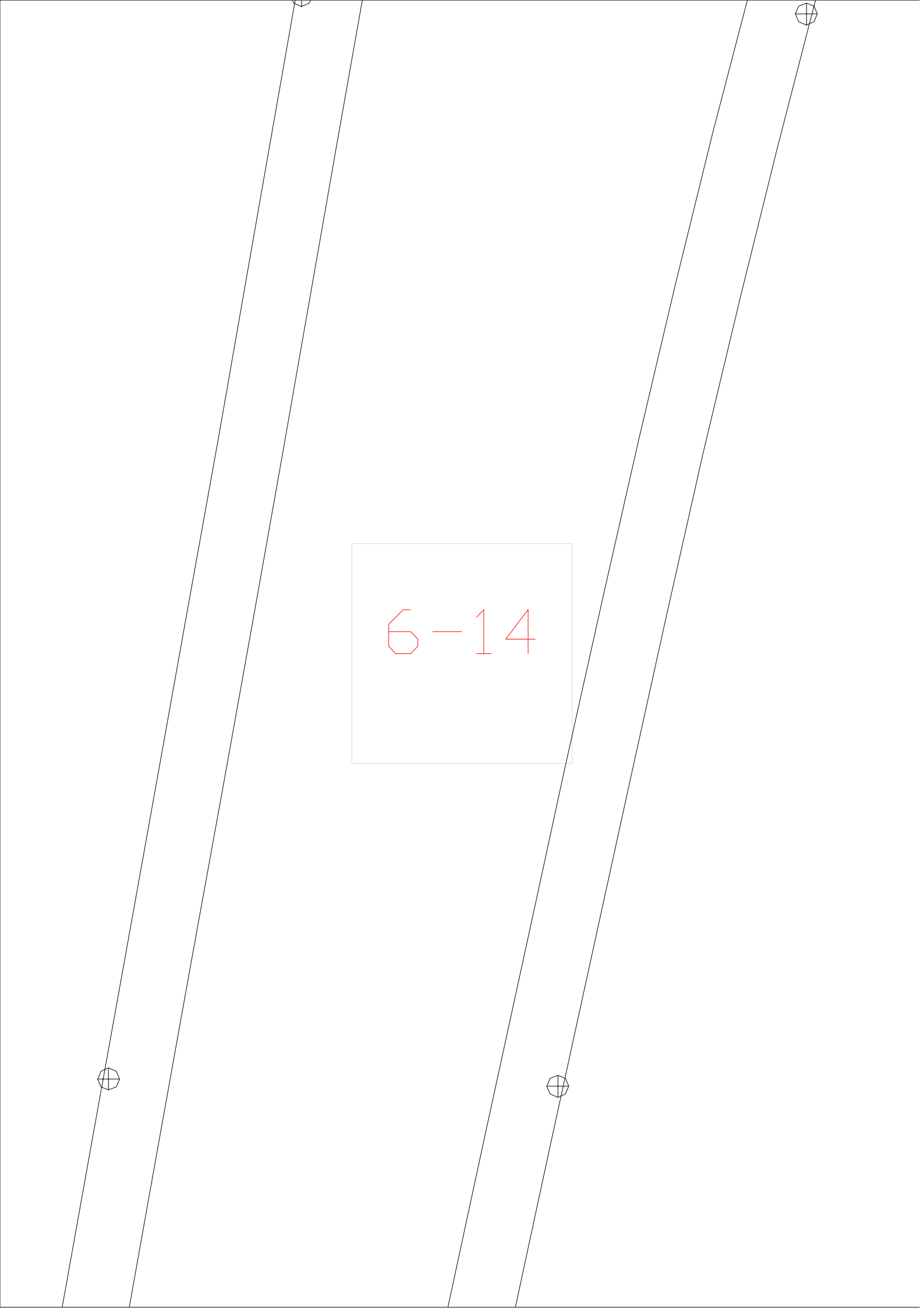

The image shows a technical drawing of a trapezoidal shape, oriented vertically. The shape is defined by two parallel vertical lines and two slanted lines connecting them. The top and bottom edges are horizontal. In the center of the shape, there is a light blue rectangular box containing the text "6-14" in red. There are four small circular symbols, each with a cross inside, located at the corners of the trapezoid: one at the top-left, one at the top-right, one at the bottom-left, and one at the bottom-right.

6-14

6-15

6-16

6-17

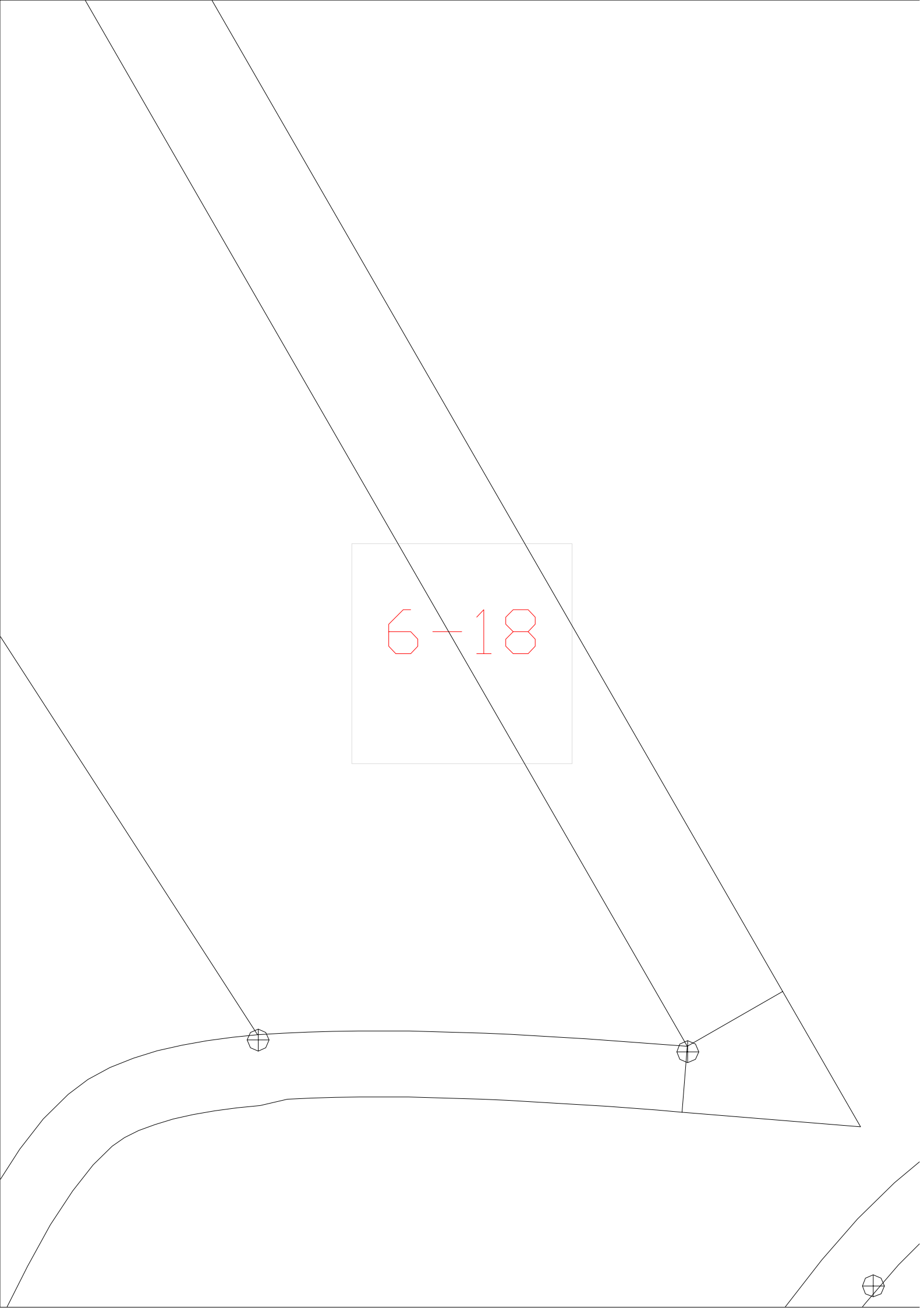

6-18

The image shows a technical drawing of a mechanical part, possibly a bracket or a support. The drawing is composed of several lines: a vertical line on the left, a horizontal line at the bottom, and two diagonal lines forming a large triangle. A curved line runs along the bottom edge of the triangle. Two circular features, each with a crosshair, are located on the lower part of the triangle. A central rectangular box contains the text '6-18' in red.

6-19

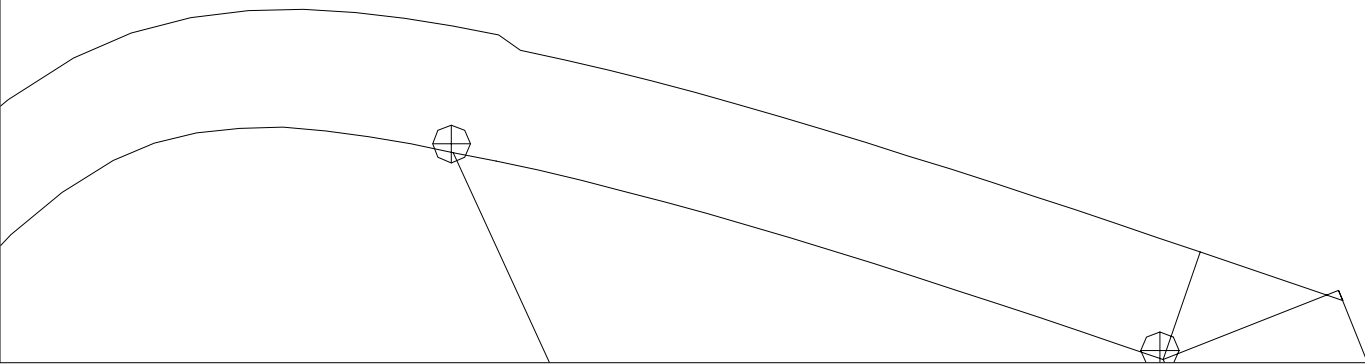

6-1



6-20

6-21

6-2

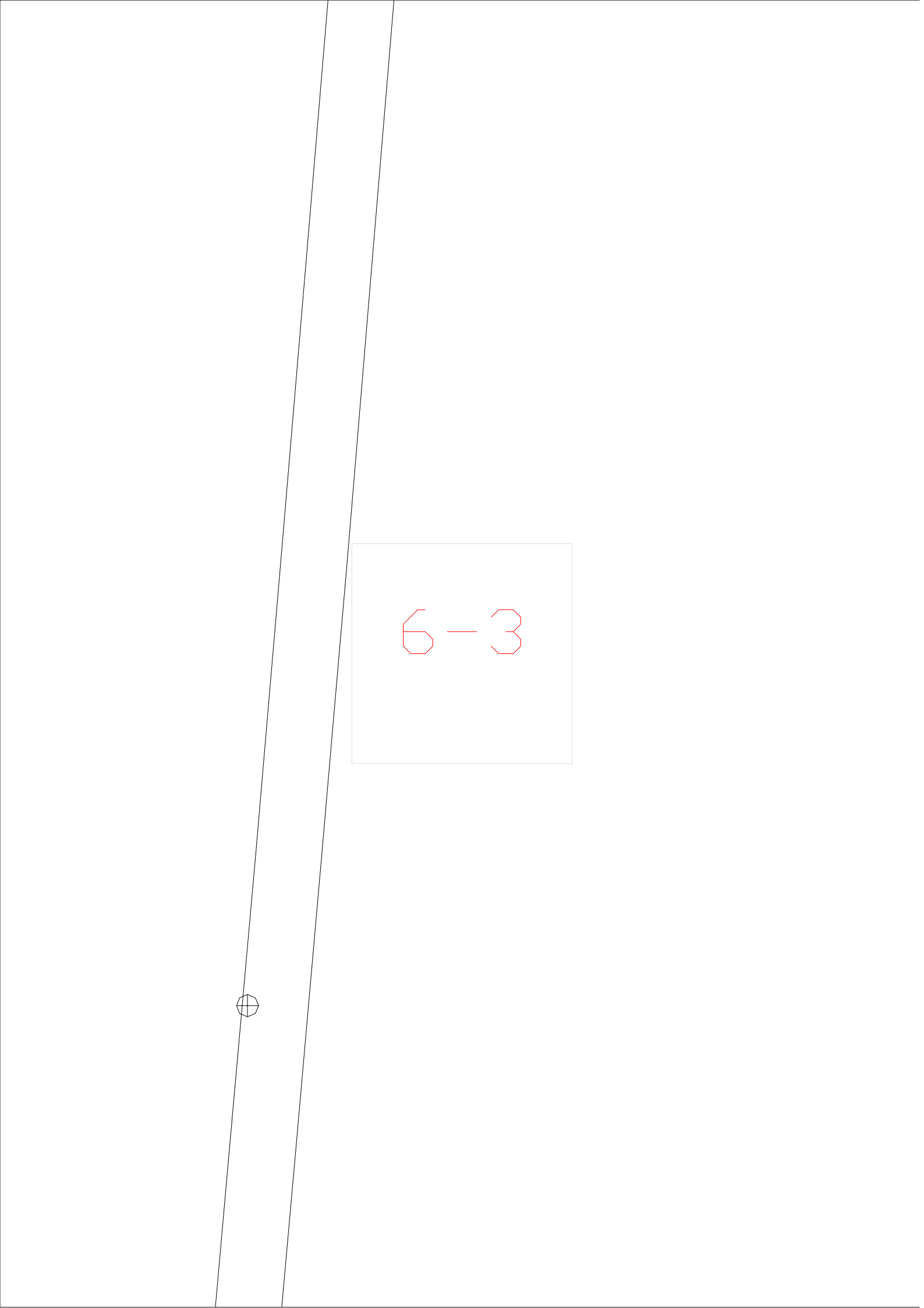

6-3

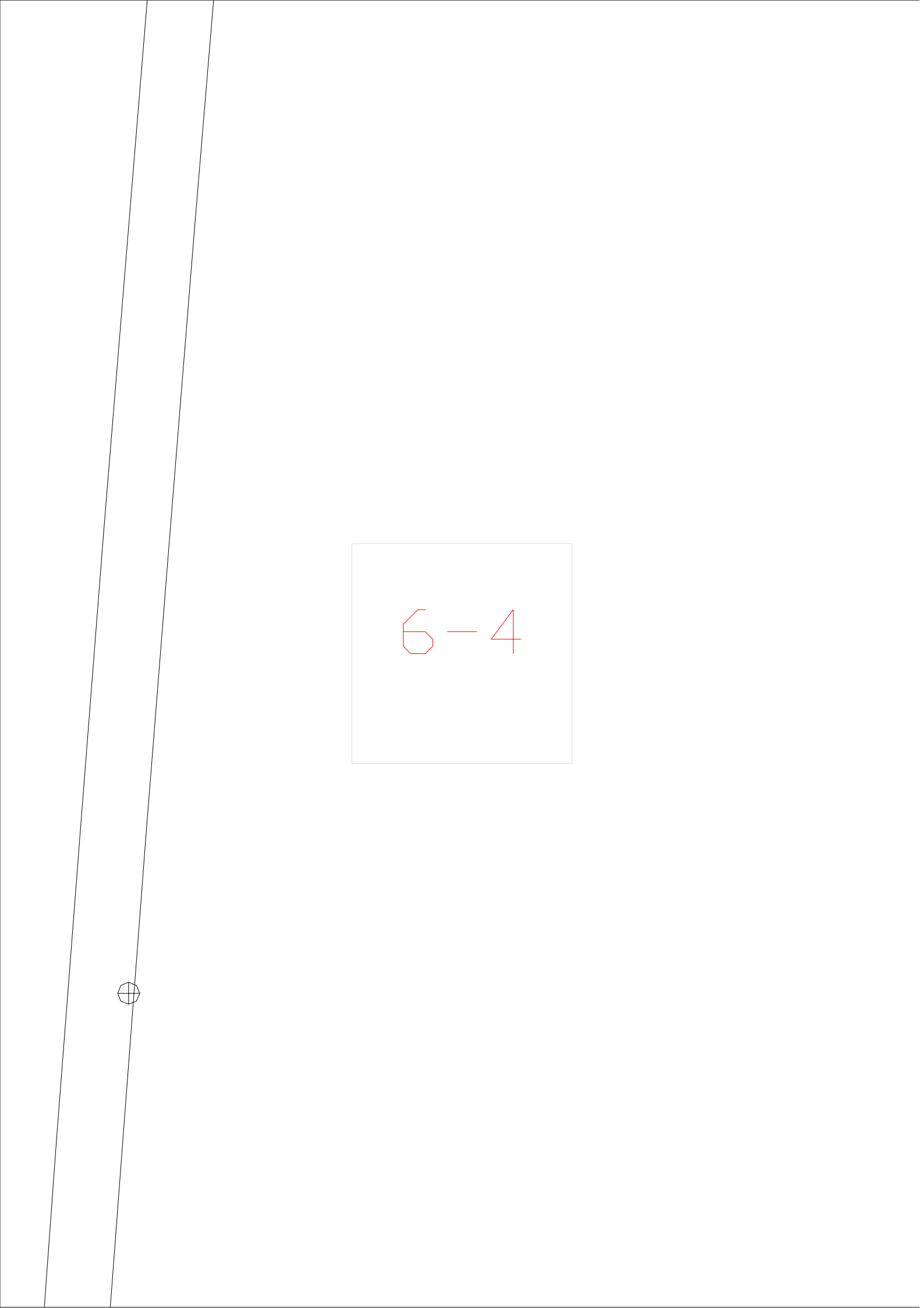

6-4

6-5



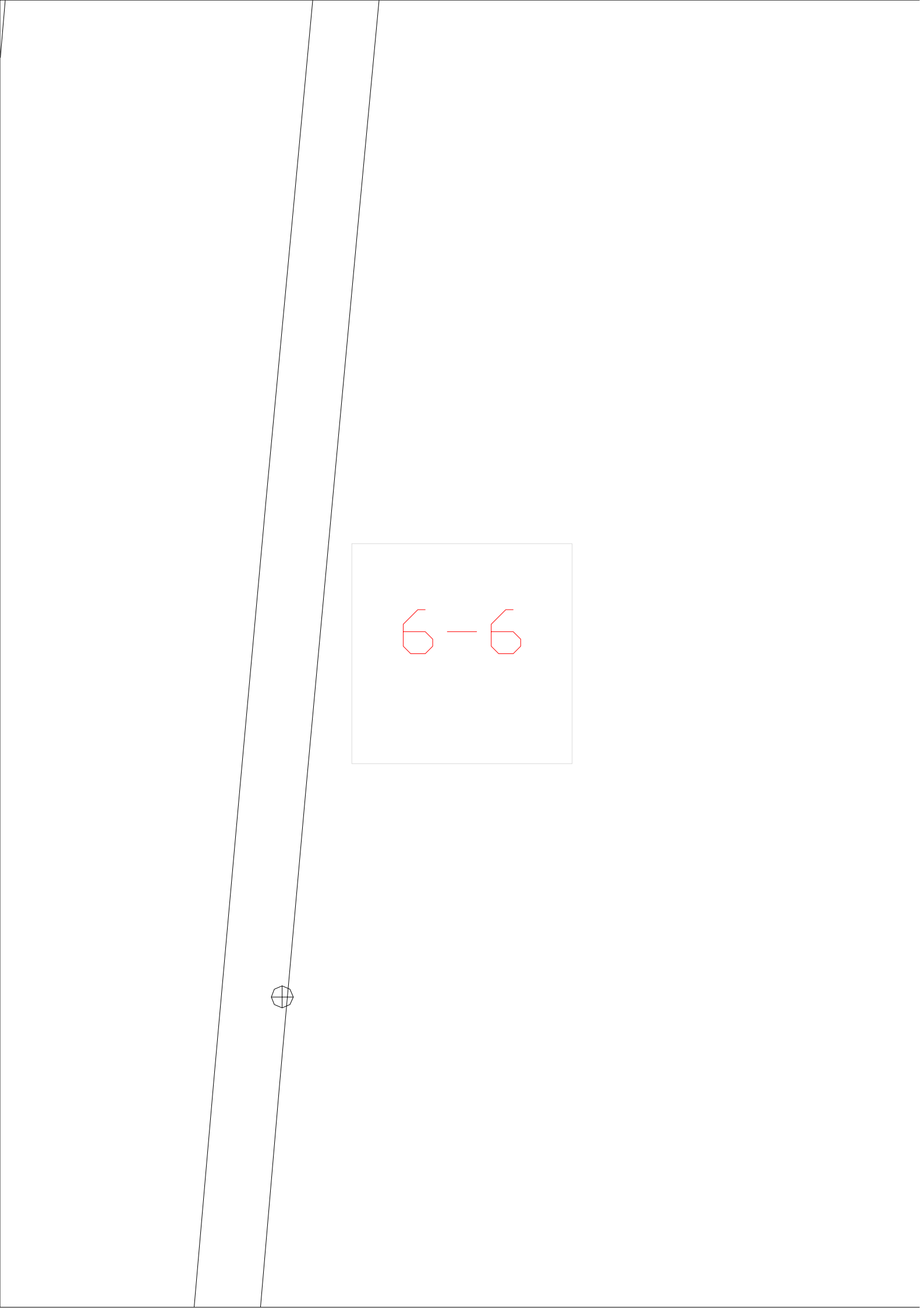

6-6

A technical drawing of a tapered shaft. The shaft is shown in profile, tapering from left to right. A circular hole is located on the shaft, with a cross-section symbol (a circle with a cross) indicating its position. A rectangular callout box is positioned to the right of the shaft, containing the text "6-6" in red, which likely refers to a specific section or feature of the shaft.

6-7

6-8



6-9

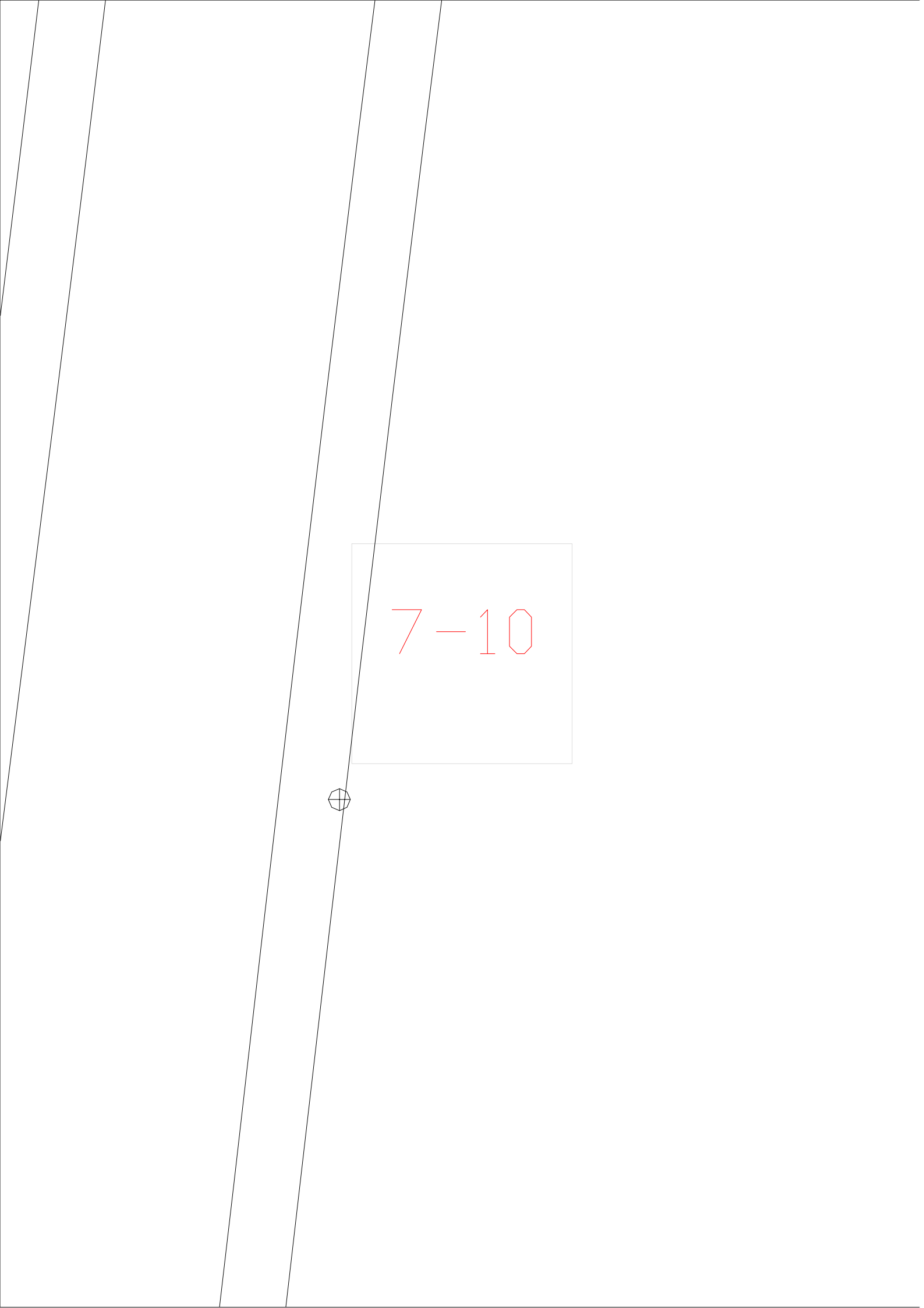

7-10

7-11



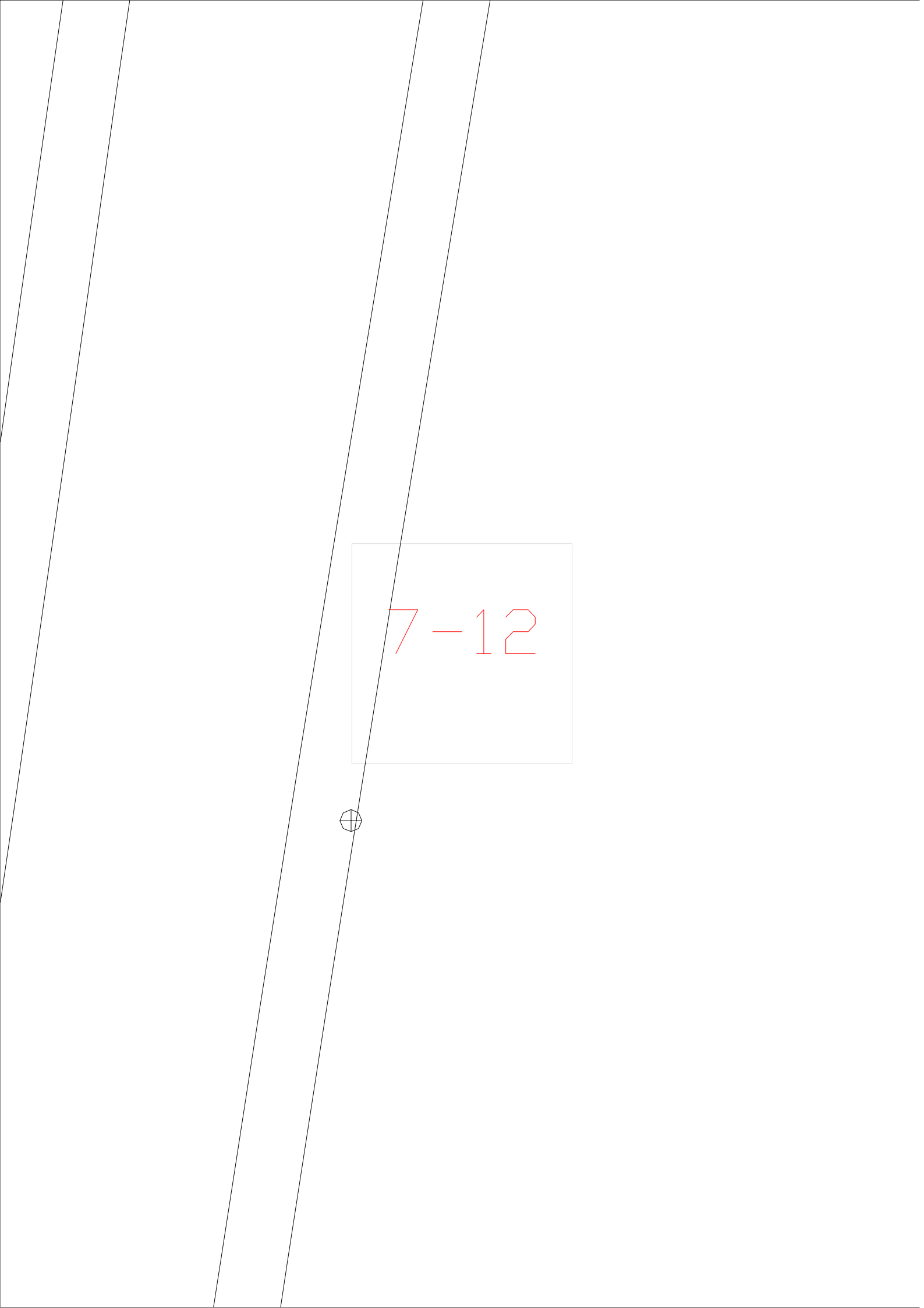

The diagram shows a vertical strip on the left side of the page, bounded by two parallel lines that are slightly slanted. A portion of this strip is shaded in light gray. Within this shaded area, there is a white rectangular box containing the text "7-12" in red. Below the box, on the right boundary line of the strip, there is a small circle with a cross inside it, representing a point.

7-12

7-13



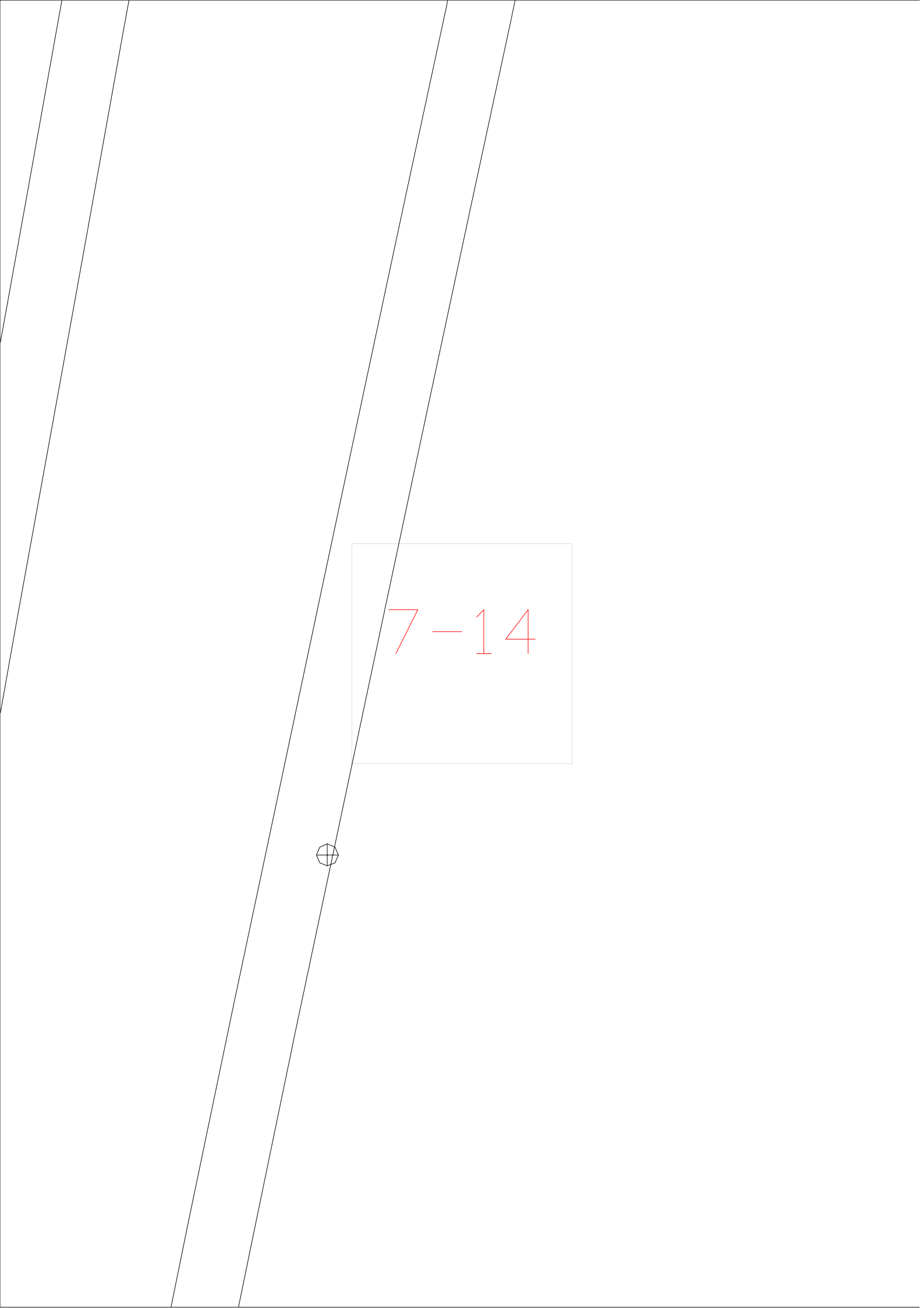

The diagram shows a cylinder with a vertical axis. A section of the cylinder is highlighted in light gray. A small circle with a cross inside is located on the surface of the cylinder, representing a cross-section. A rectangular box highlights the text $7 - 14$.

$$7 - 14$$

7-15



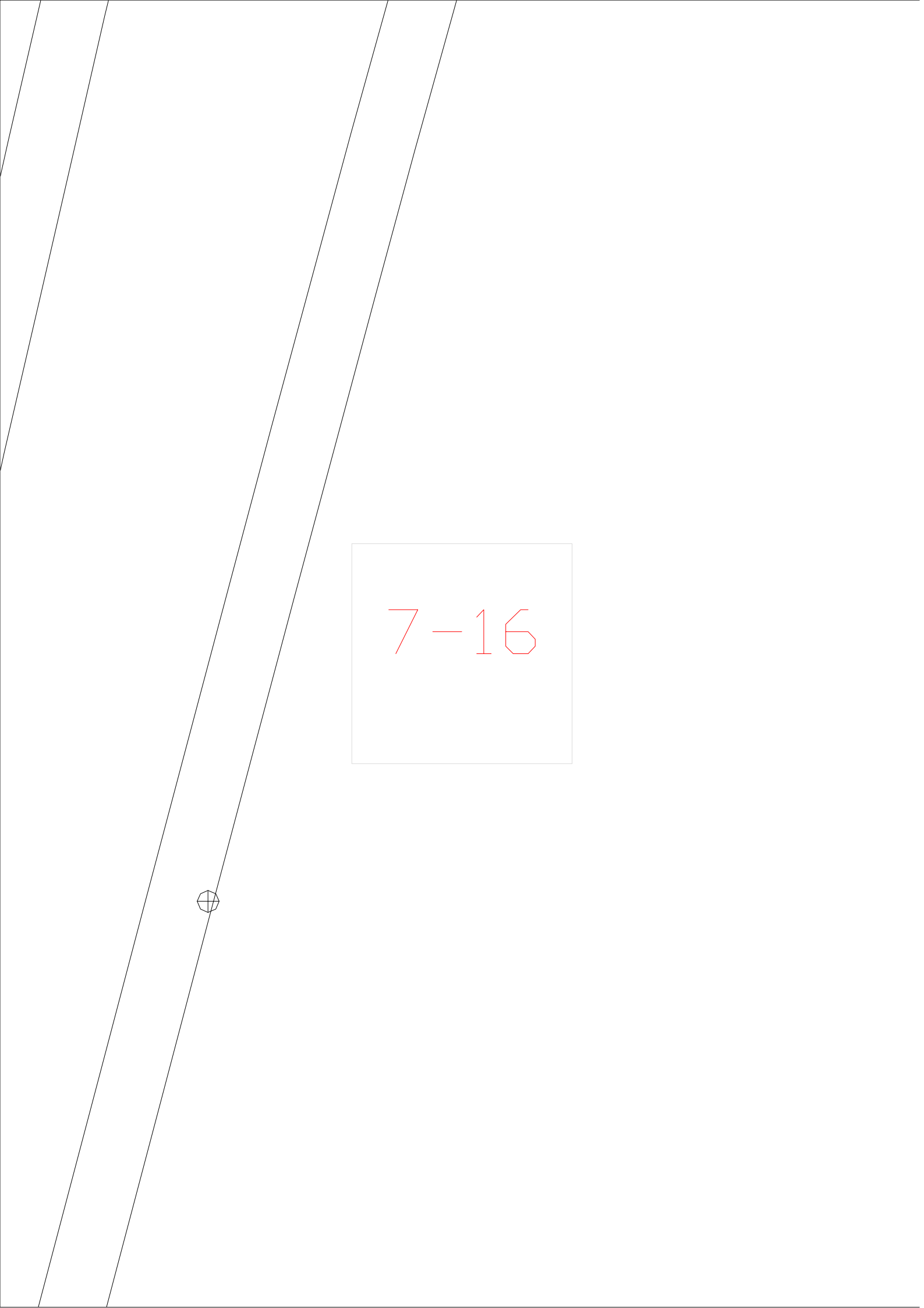

7-16

7-17



7-18





7-19

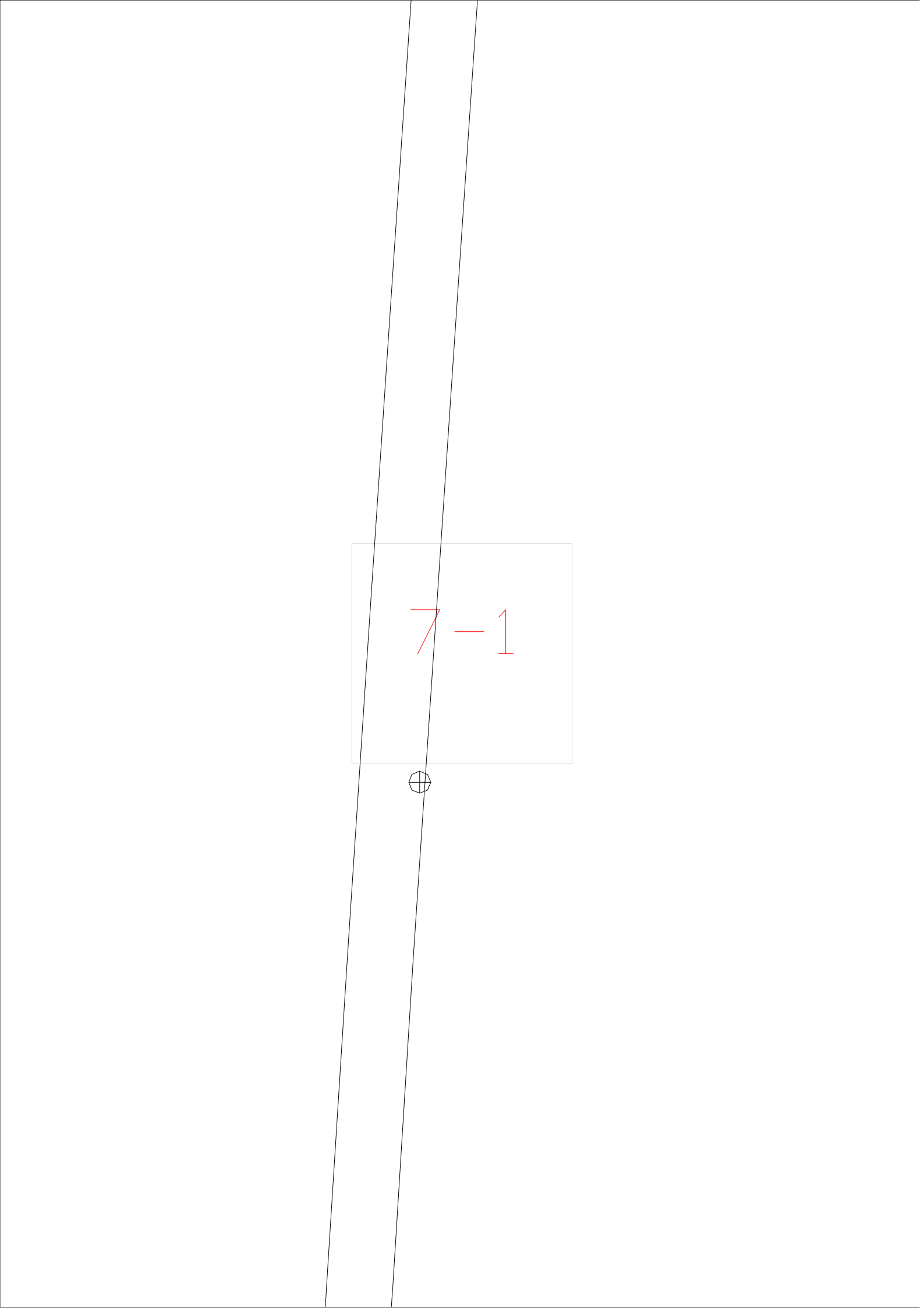

A diagram showing a vertical shaft with a rectangular box containing the equation $7 - 1$ and a bolt symbol below it.

$$7 - 1$$



7-20

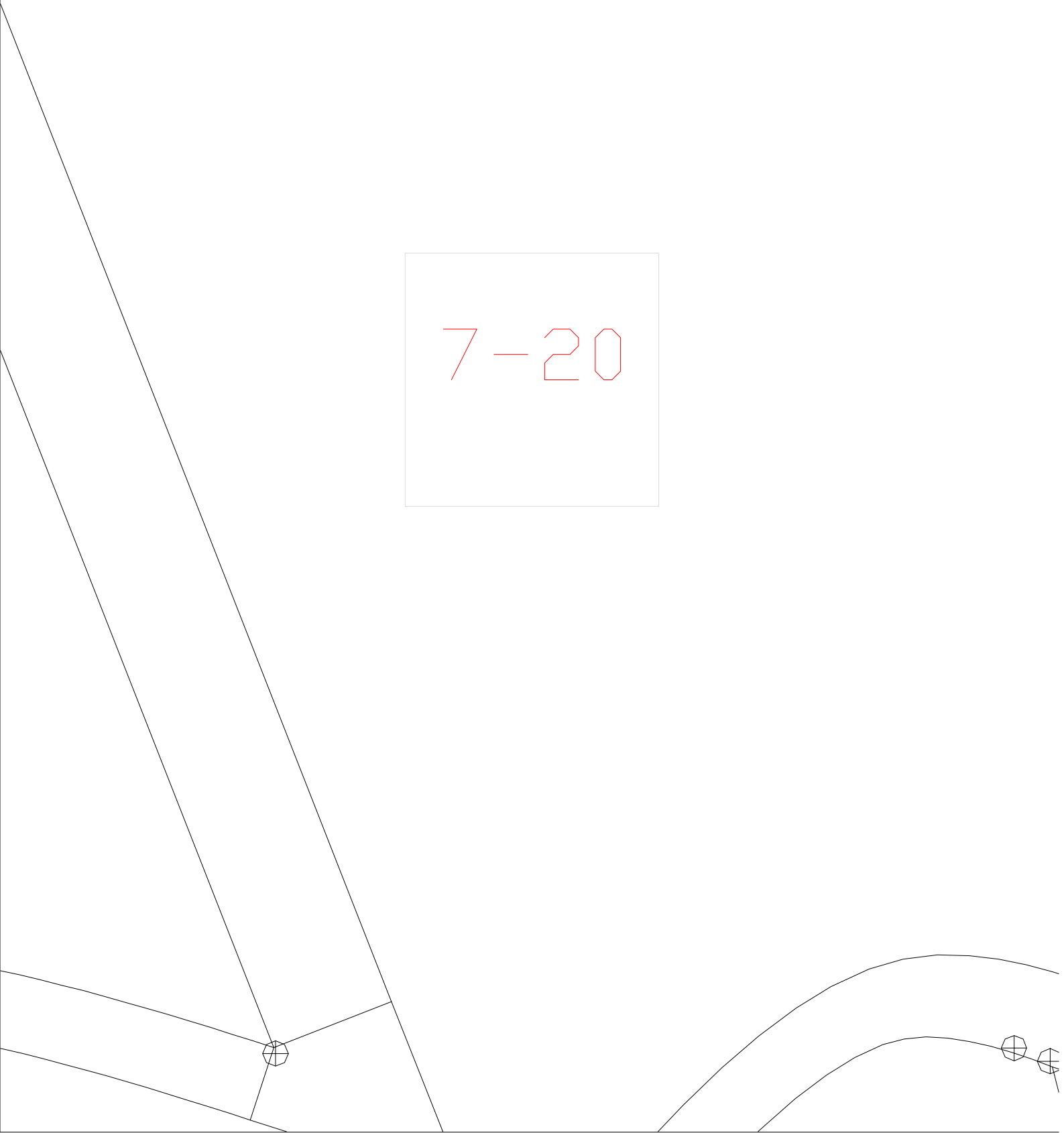

7-21

7-2



The image features a central white square box with a thin black border, containing the red text "7-3". To the left of this box, there is a small black circle with a cross inside, positioned on one of the lines. The background is white and contains several thin, parallel black lines that are slightly slanted, creating a sense of depth or perspective.

$$7-3$$

$$7 - 4$$

$$7 - 5$$





7-6

7-7





7-8

7-9





8-10

8-11





8-12

8-13



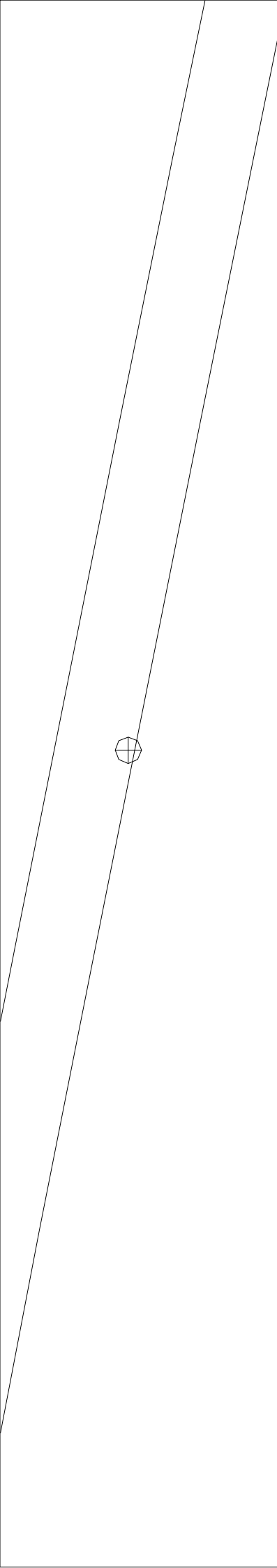

$$8 - 14$$

8-15



8-16

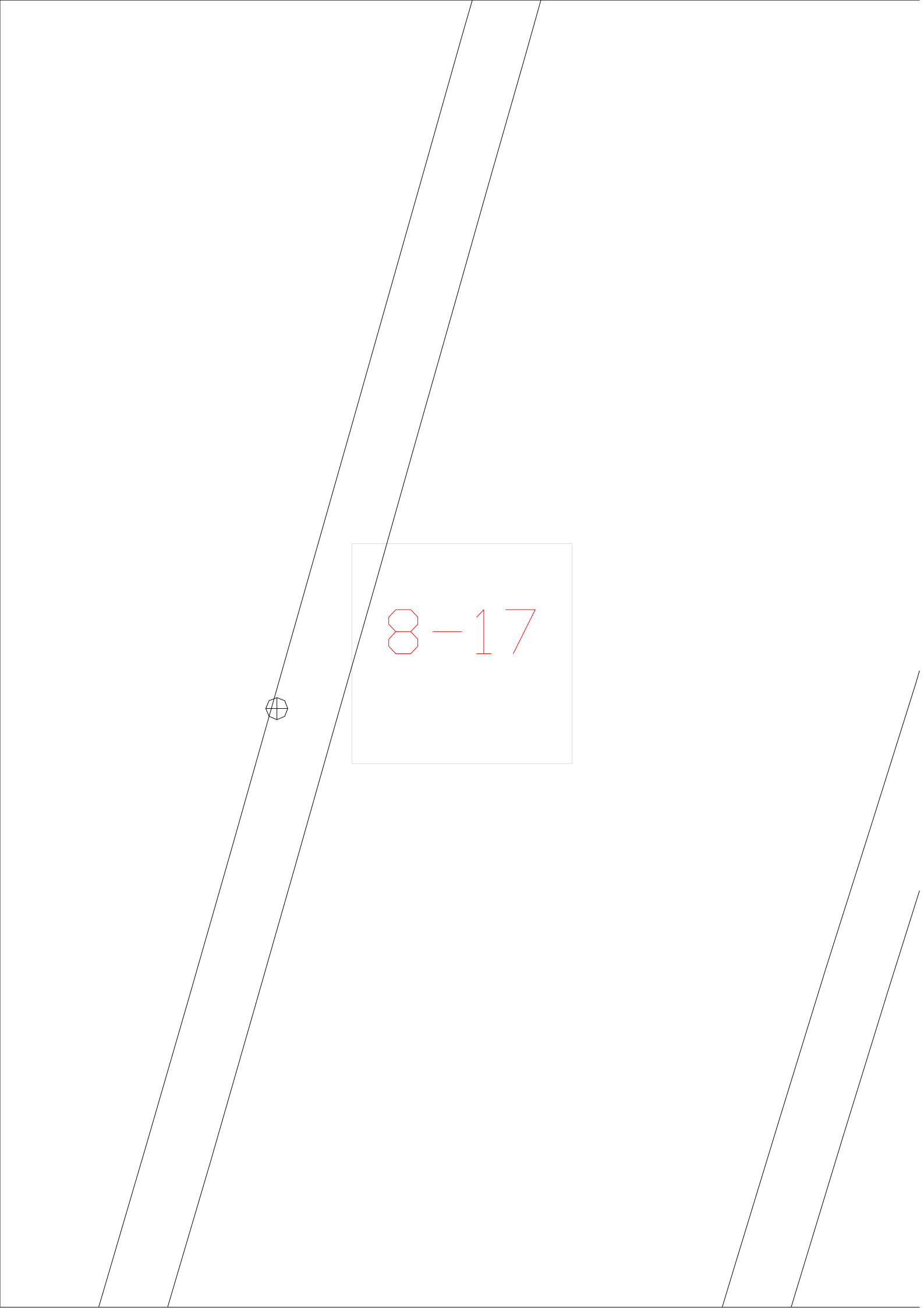

8-17

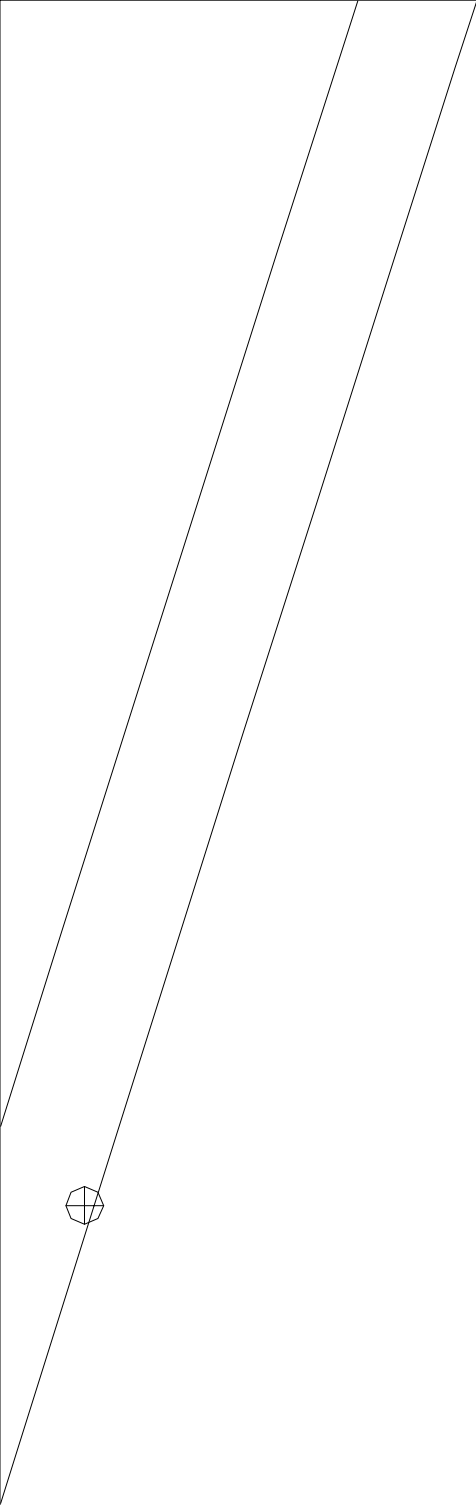

$$8 - 18$$



8-19



8-1

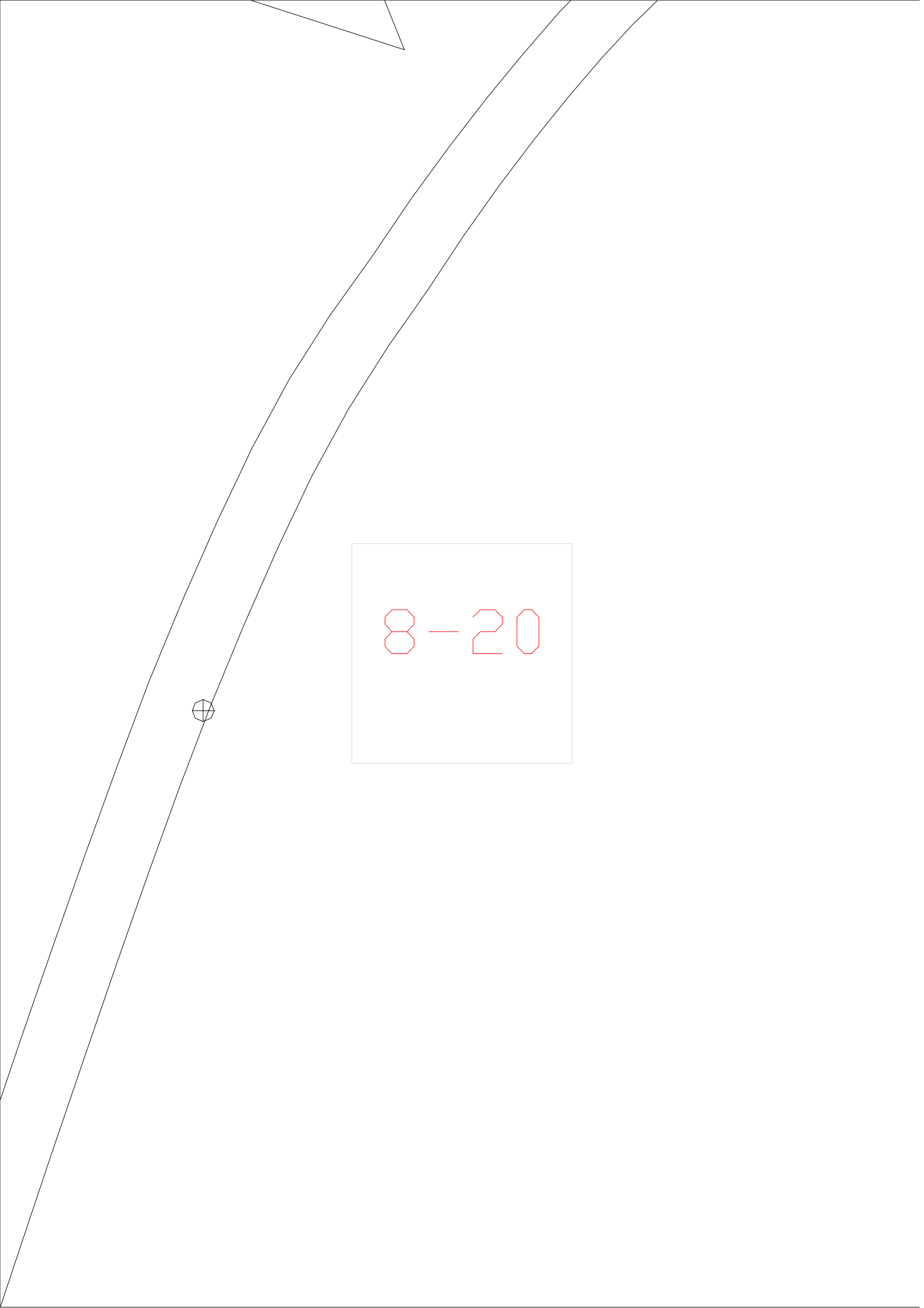

8-20

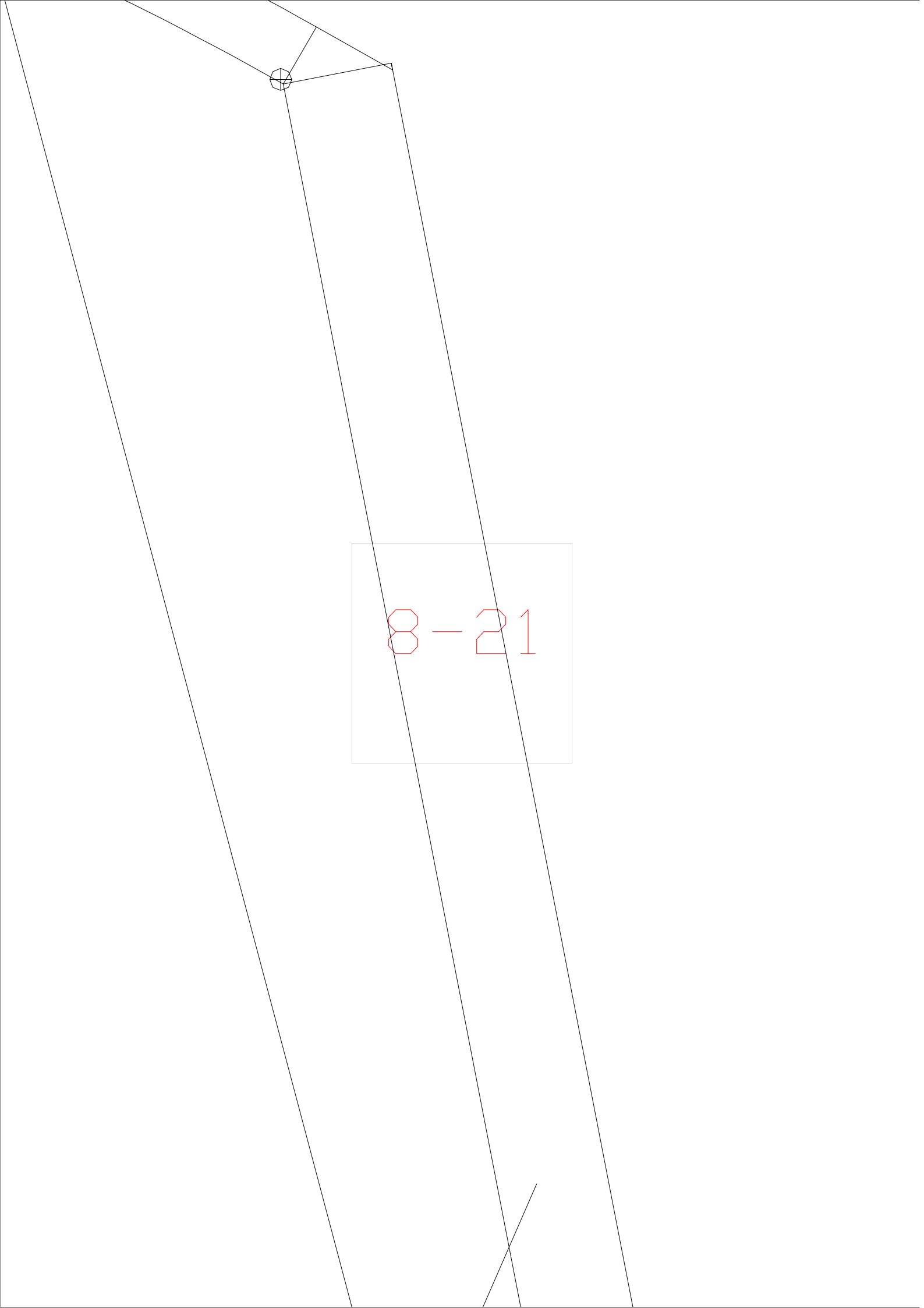

8-21

8-2

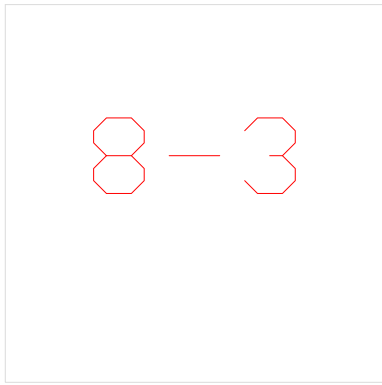
$$8-3$$



$$8 - 4$$

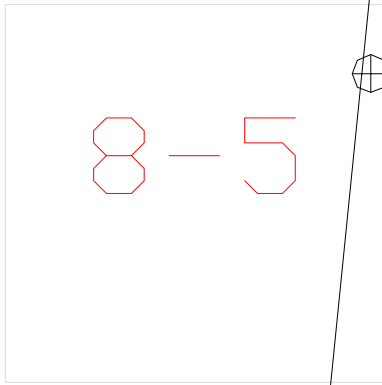



8-6

$$8 - 7$$





8-9





9-10



9-11

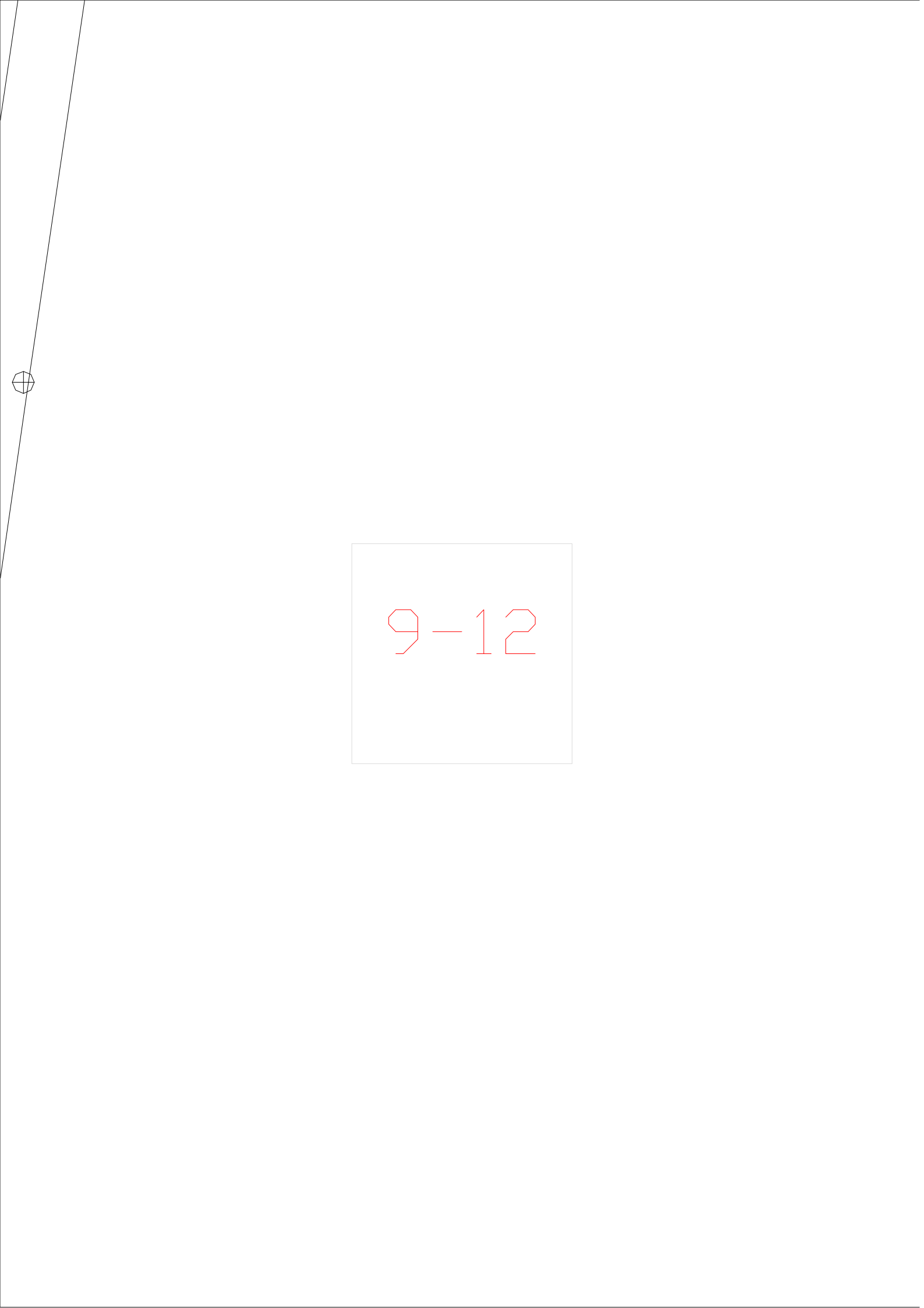

9-12

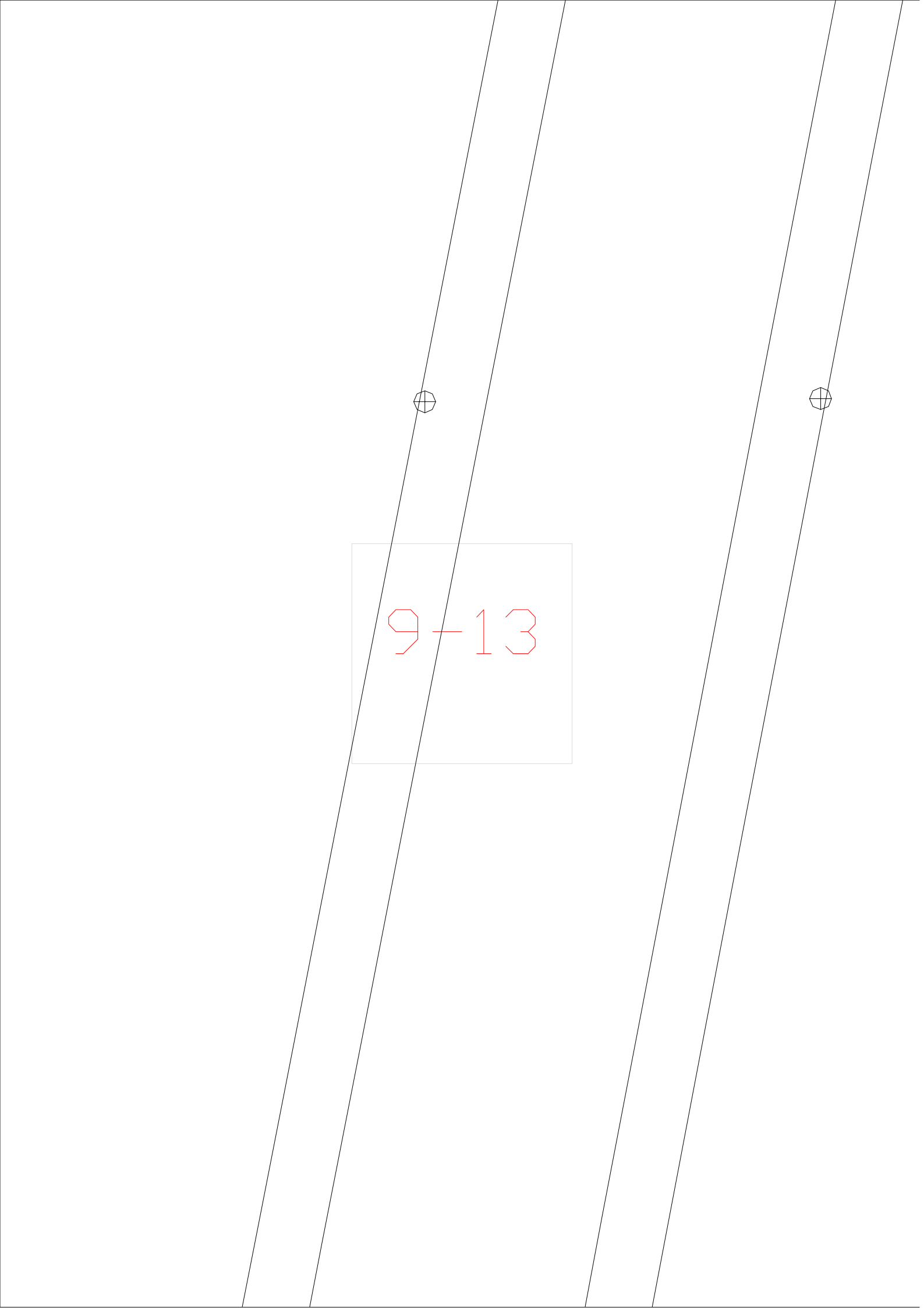

The diagram features two pairs of parallel lines slanted at an angle. Each line in both pairs has a small circle with a cross inside, positioned at the top. A light gray rectangular box is centered between the two pairs of lines, containing the text "9-13" in red.

9-13

9-14



9-15

9-16



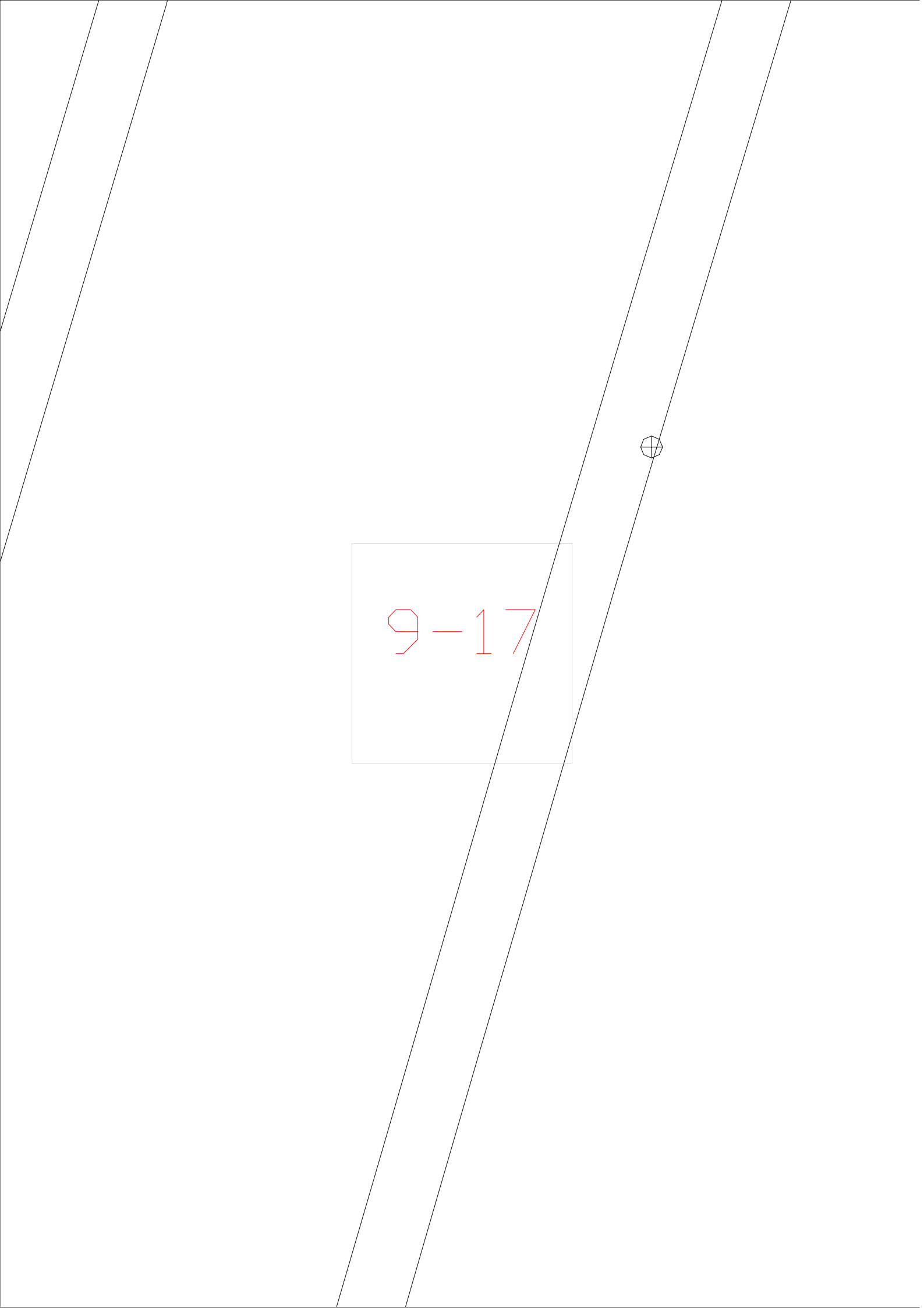

9-17

$$9 - 18$$



9-19





9-1

9-20

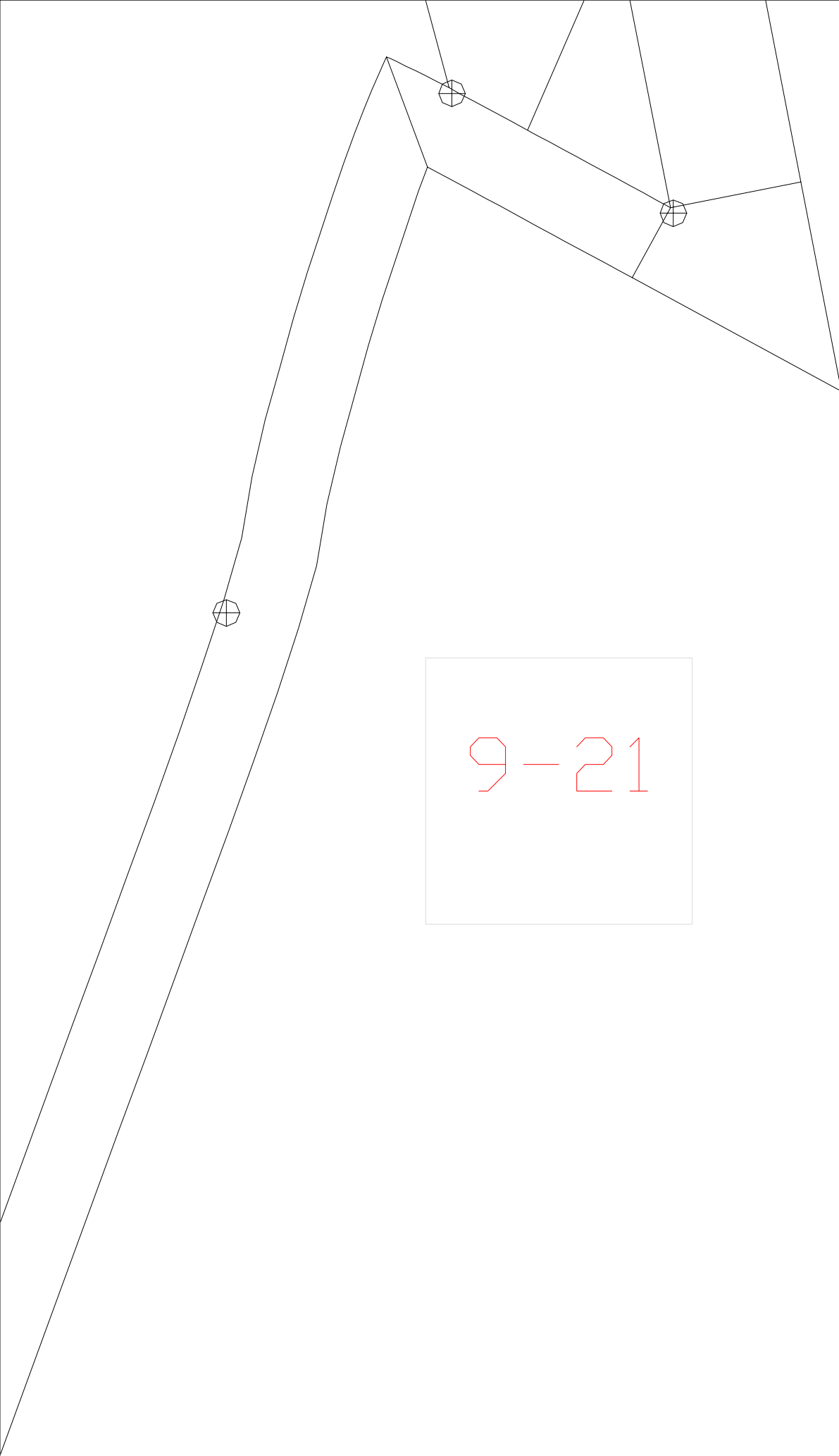

9-21

9-2



9-3



$$9 - 4$$

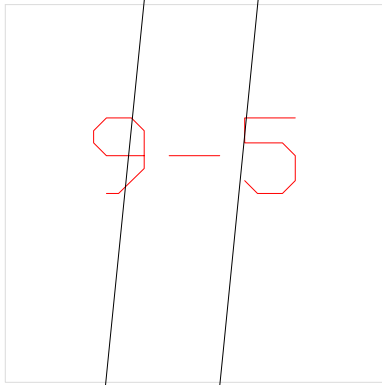



9-6



9-7



9 - 8

9-9



PRIMARY ROD

SECONDARY ROD

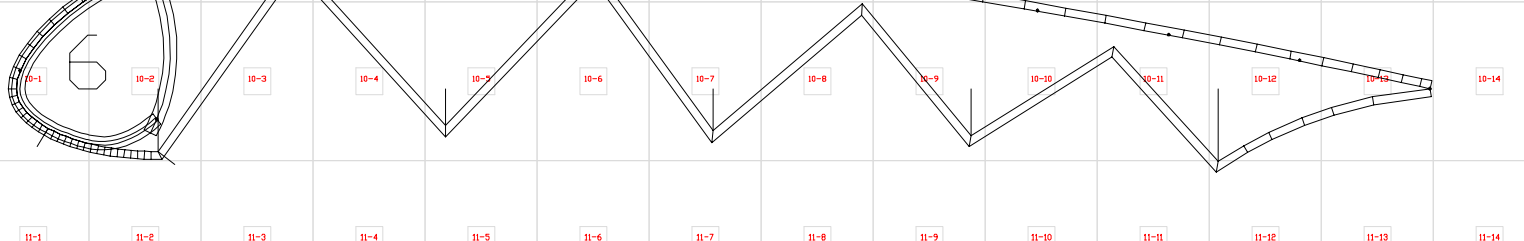
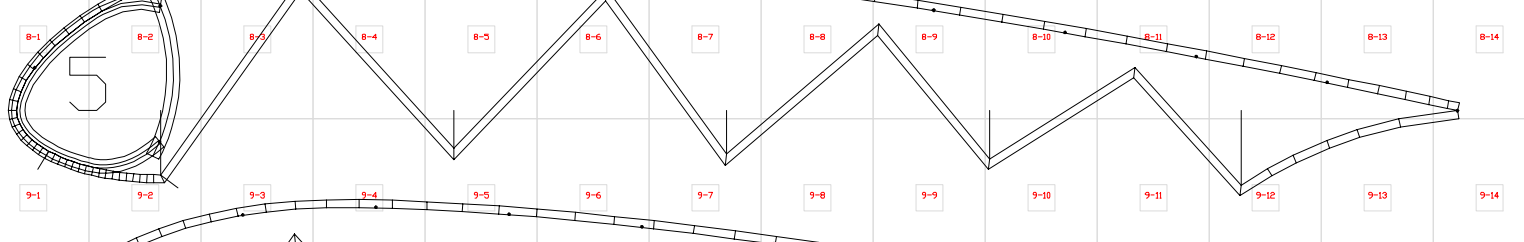
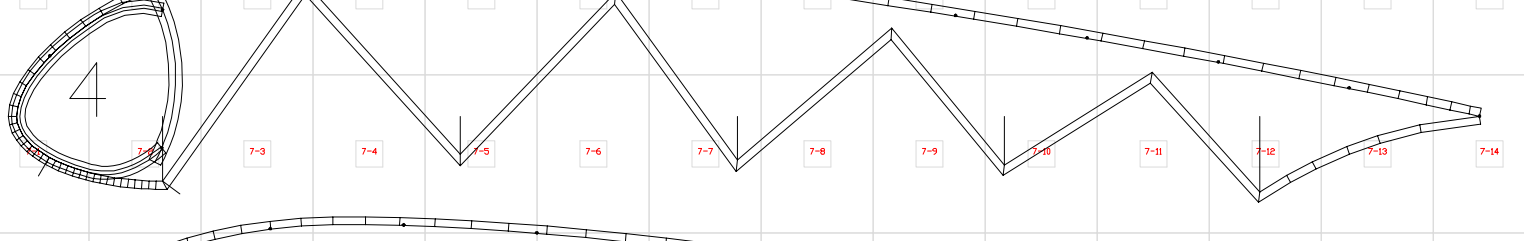
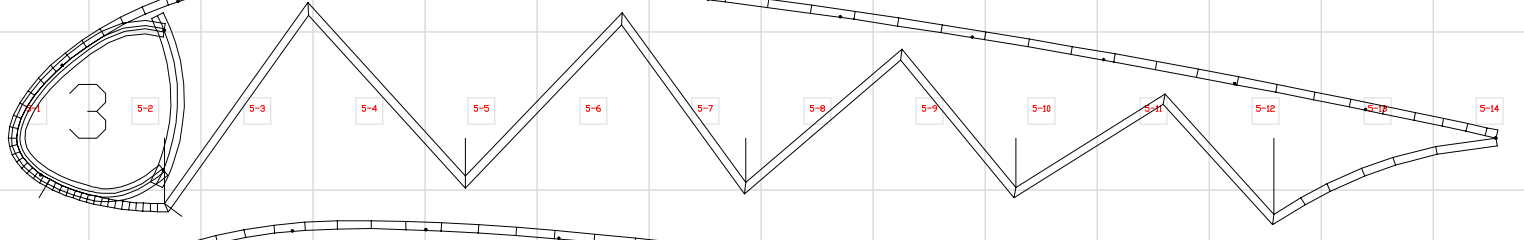
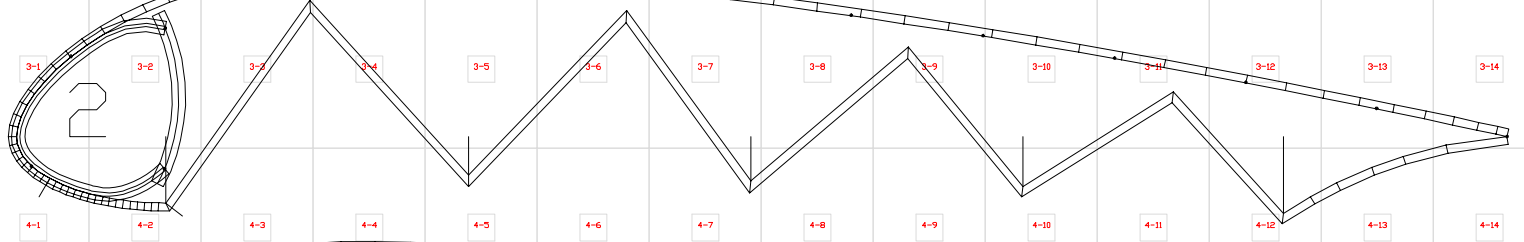
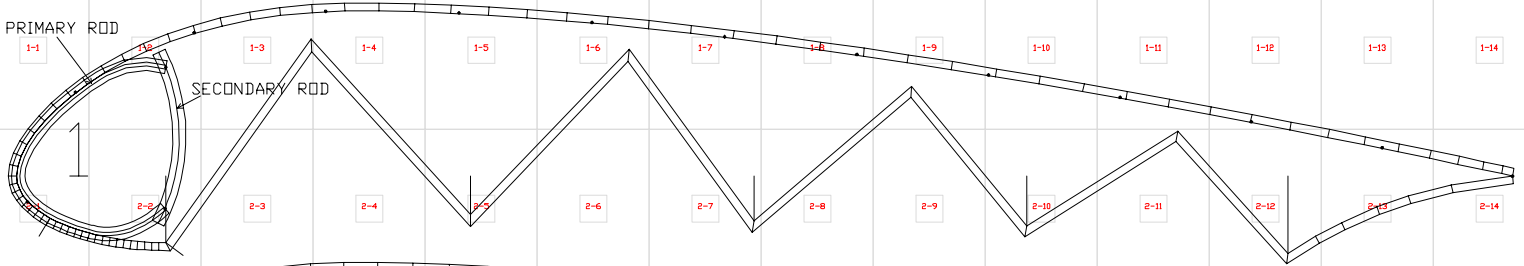



10-10

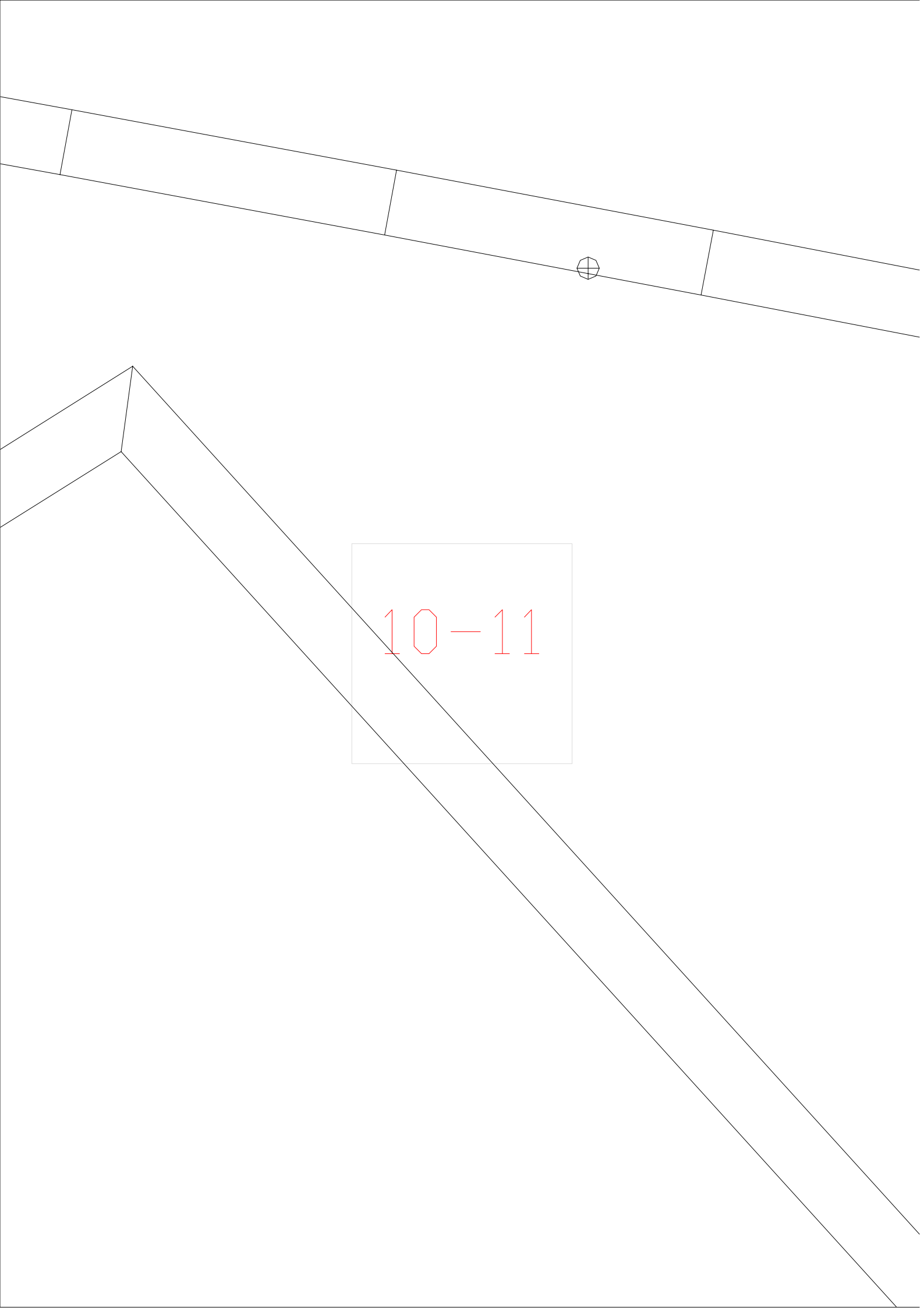

10-11

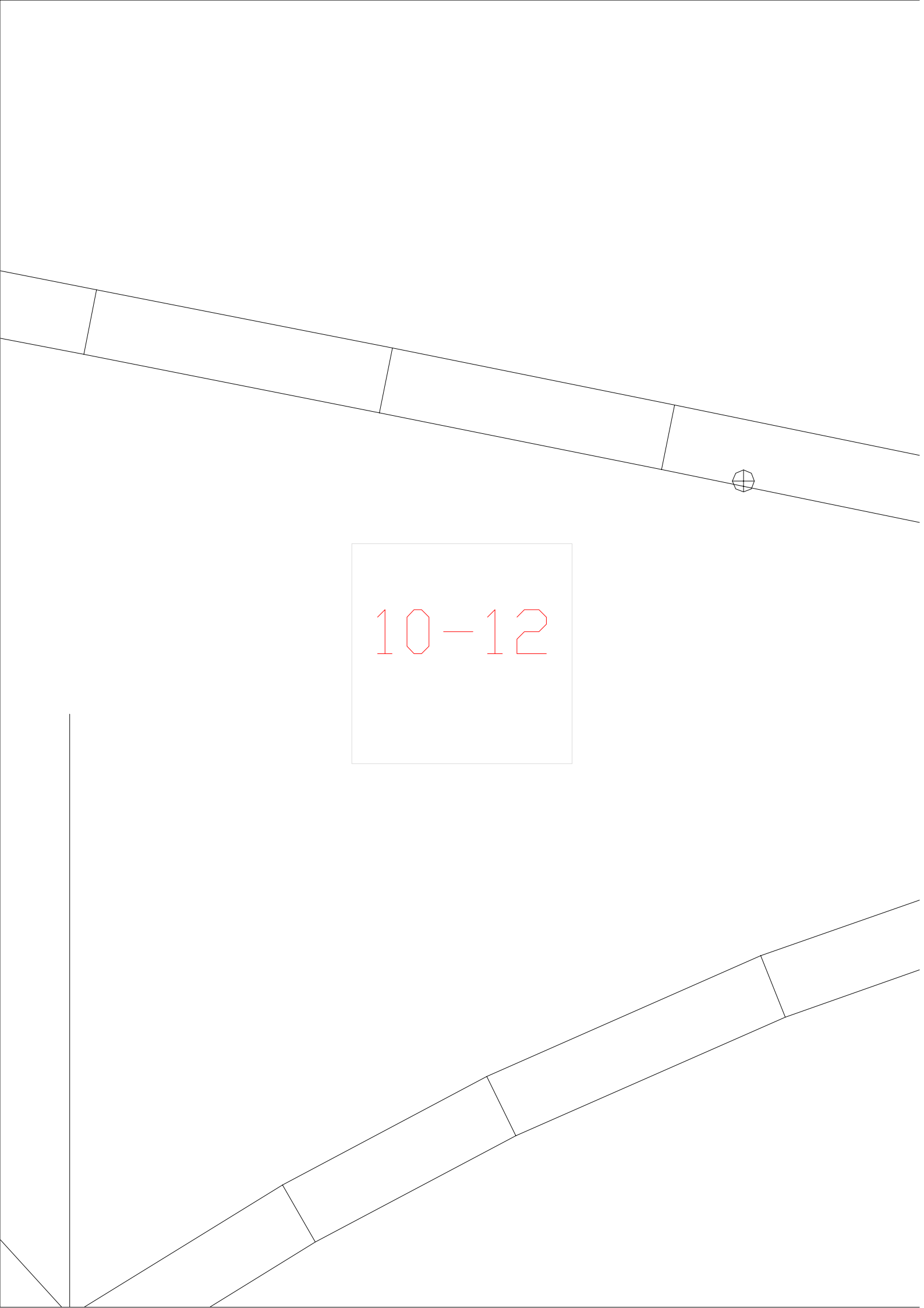

10-12

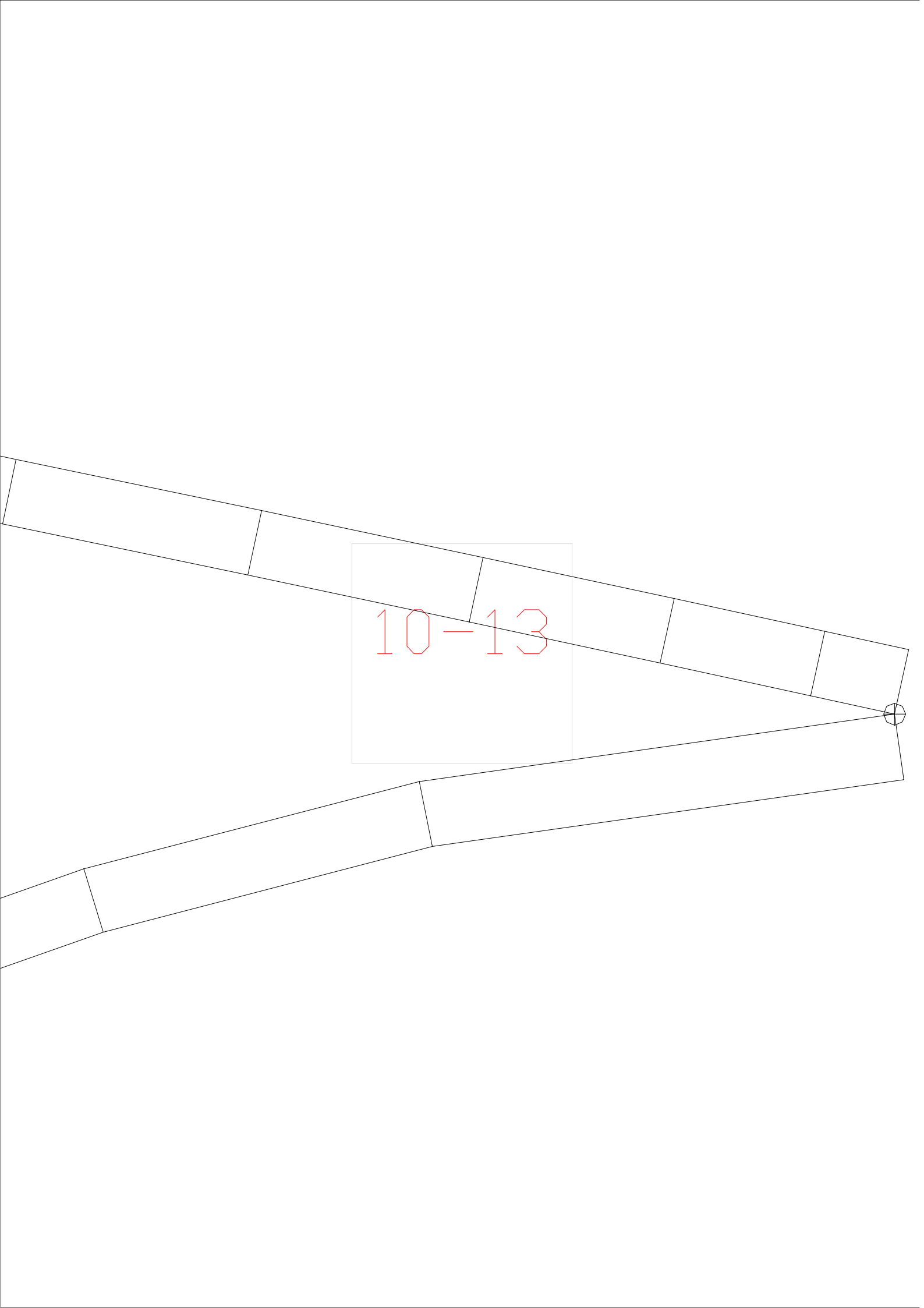

10-13

10-14

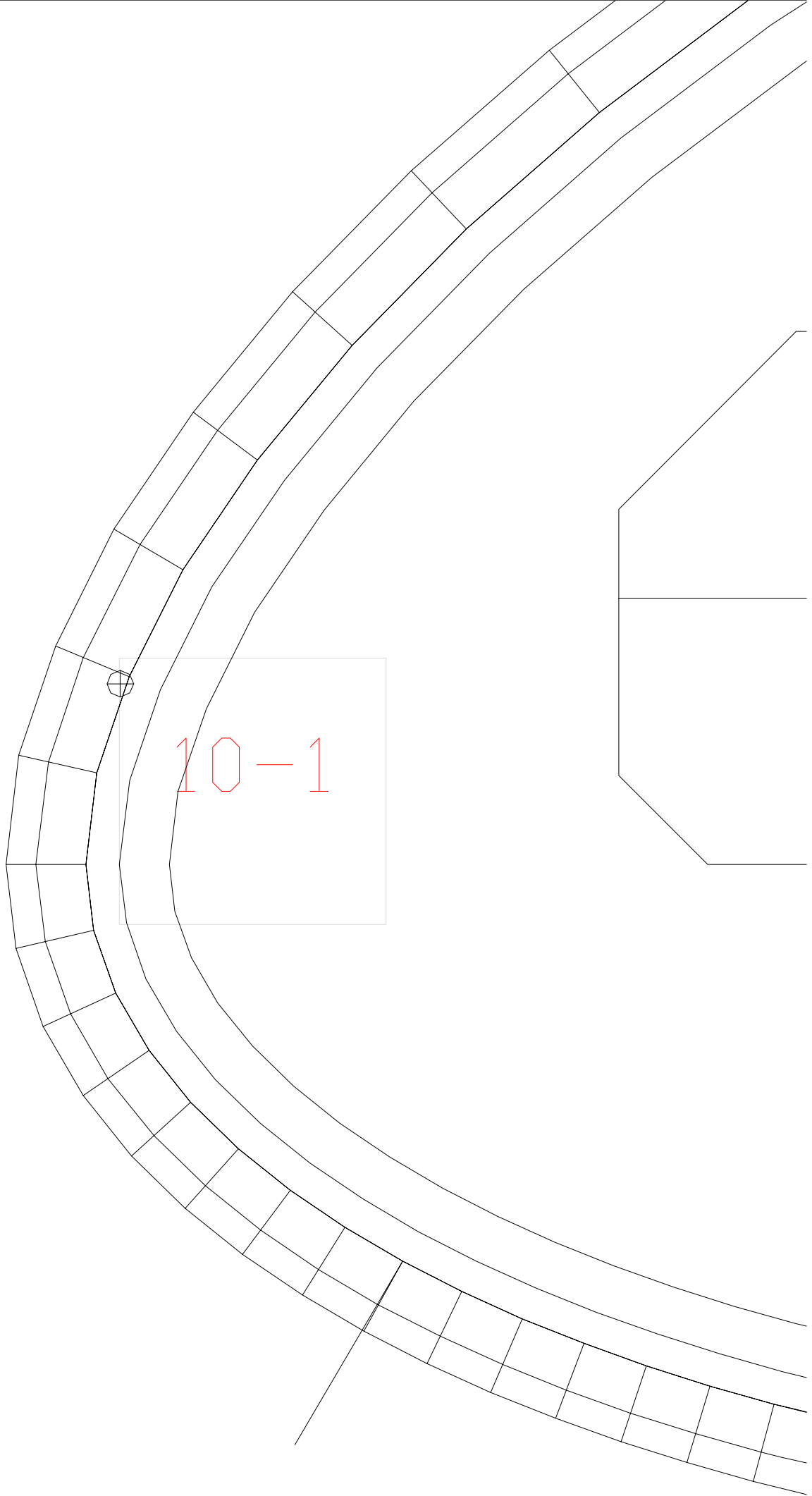

10-1

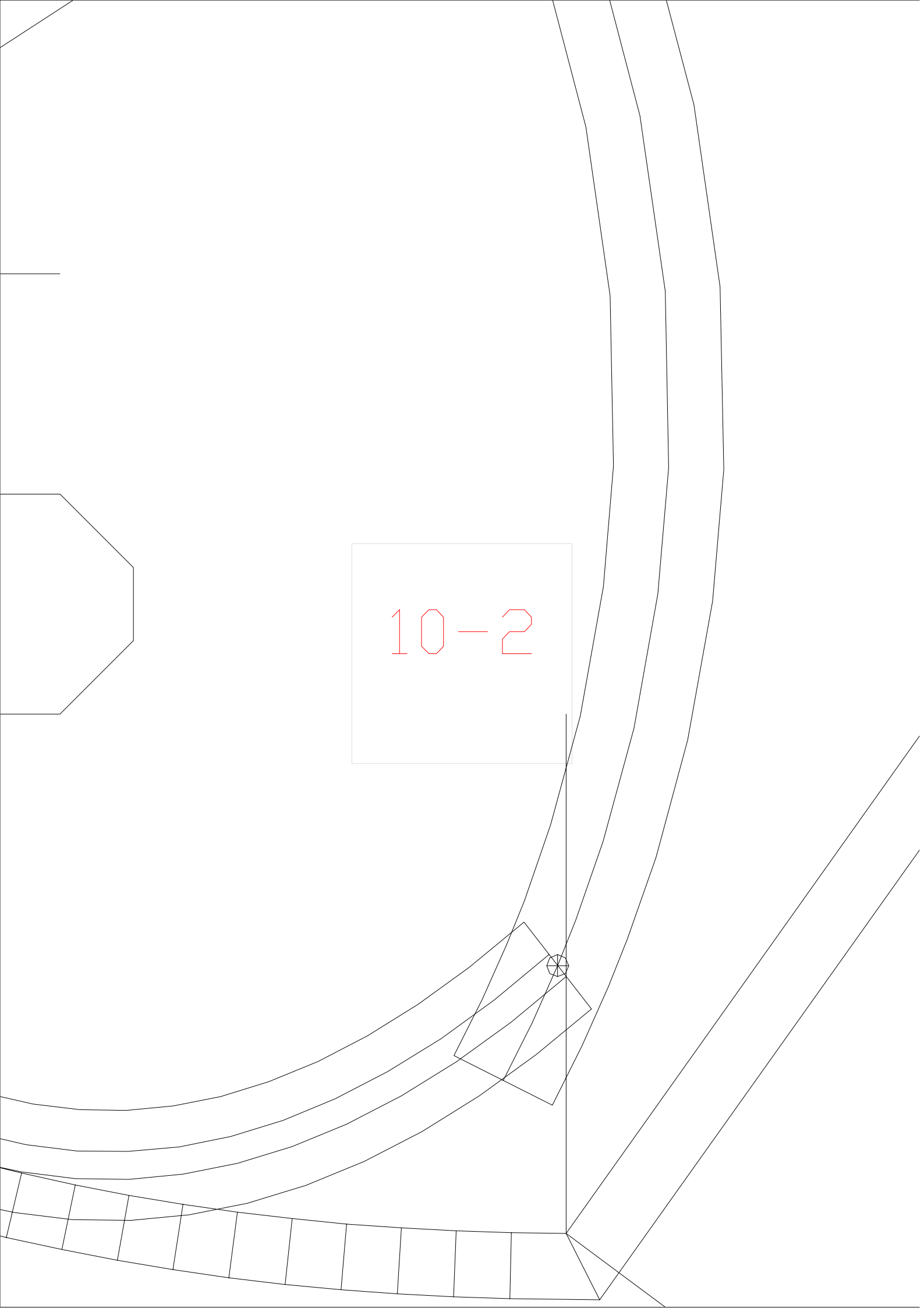

10-2

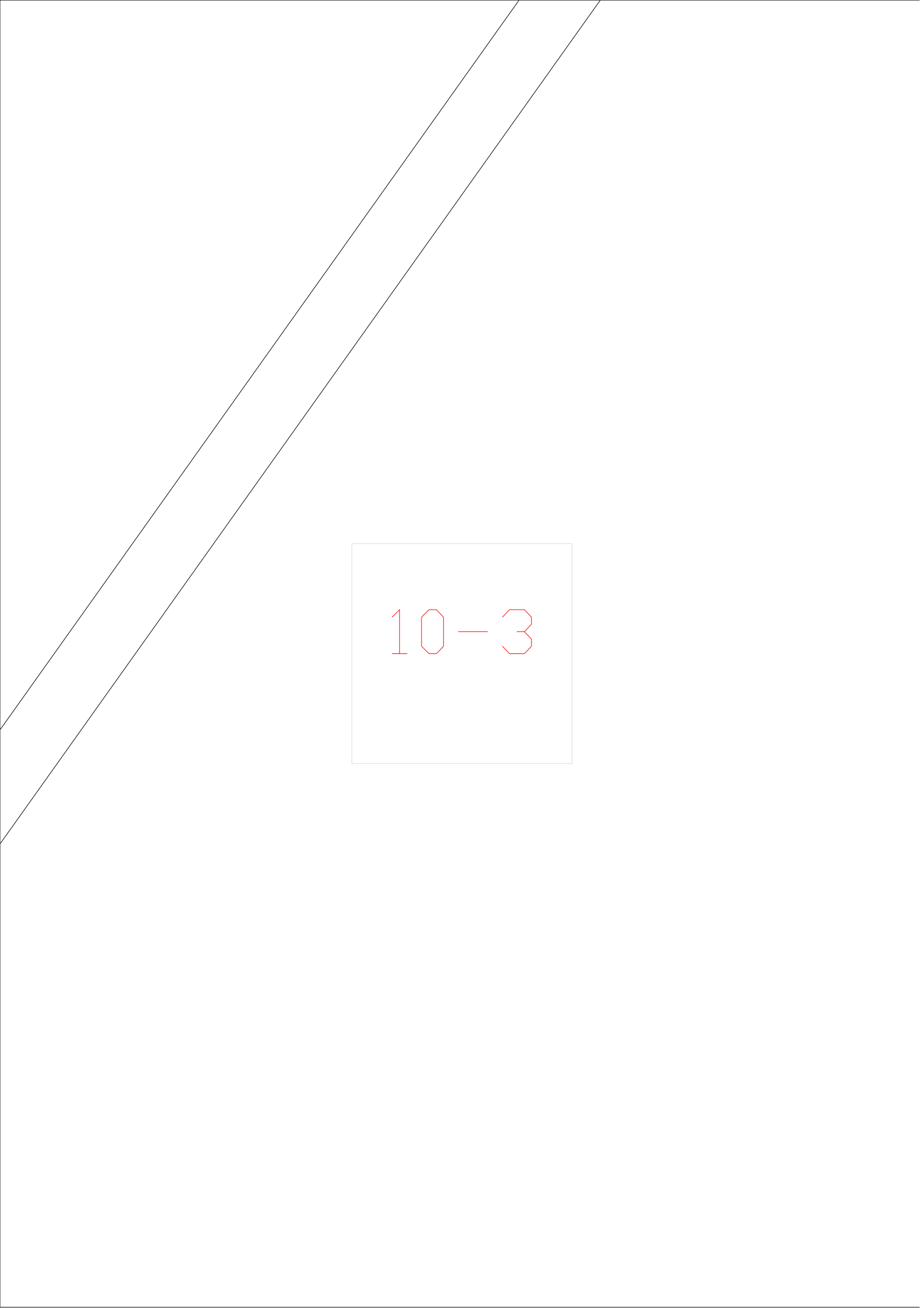

10-3

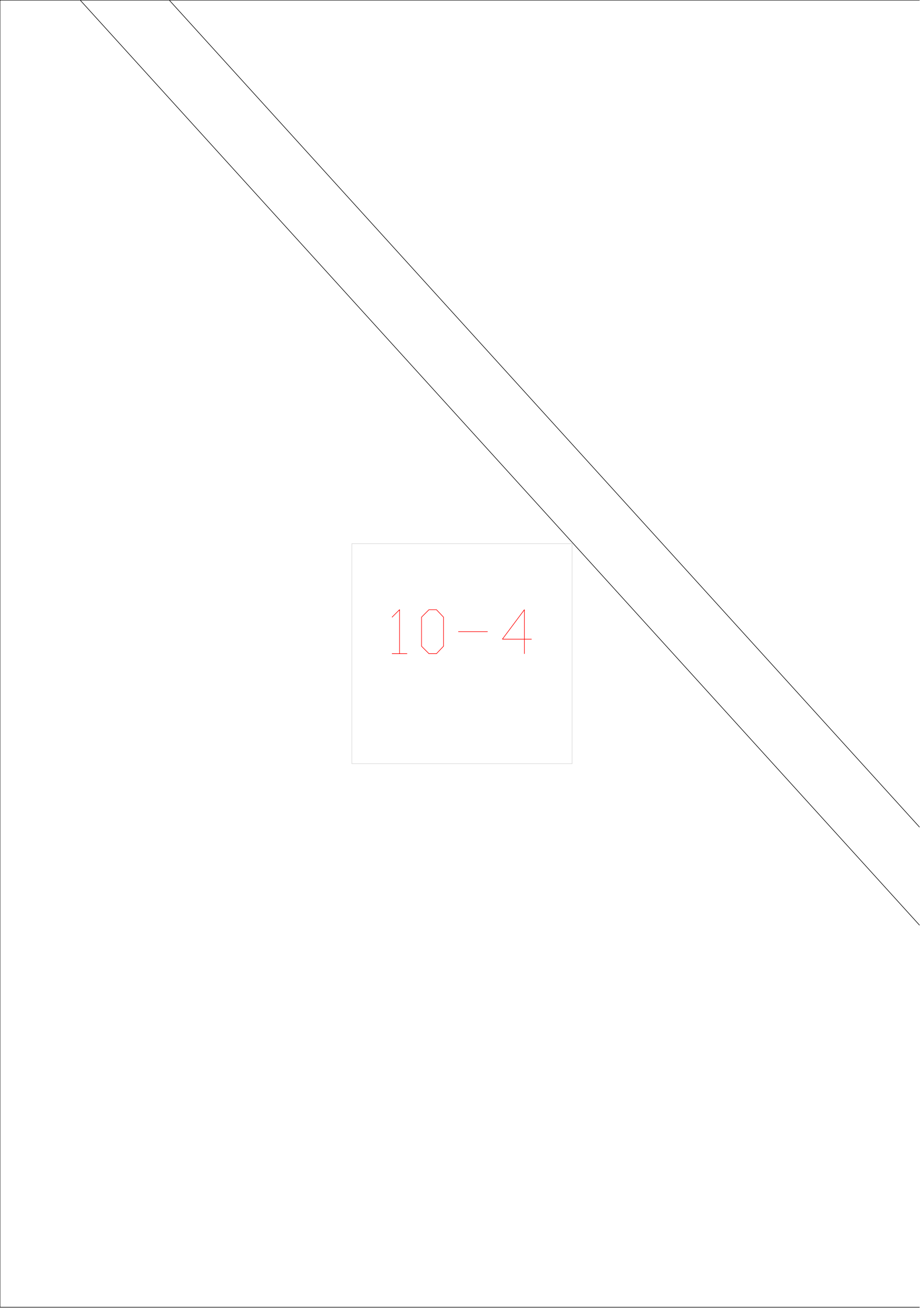

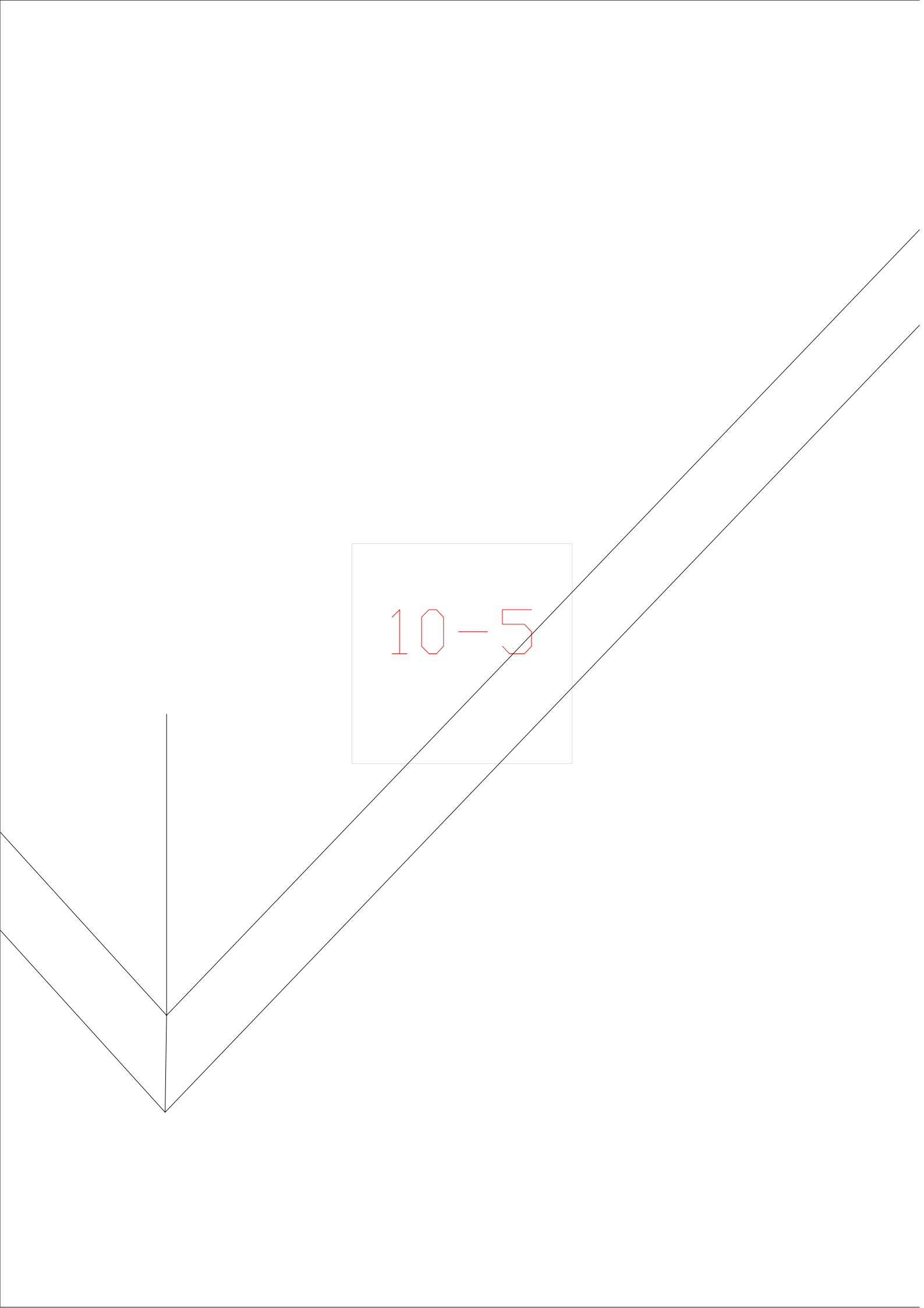
$$10 - 4$$

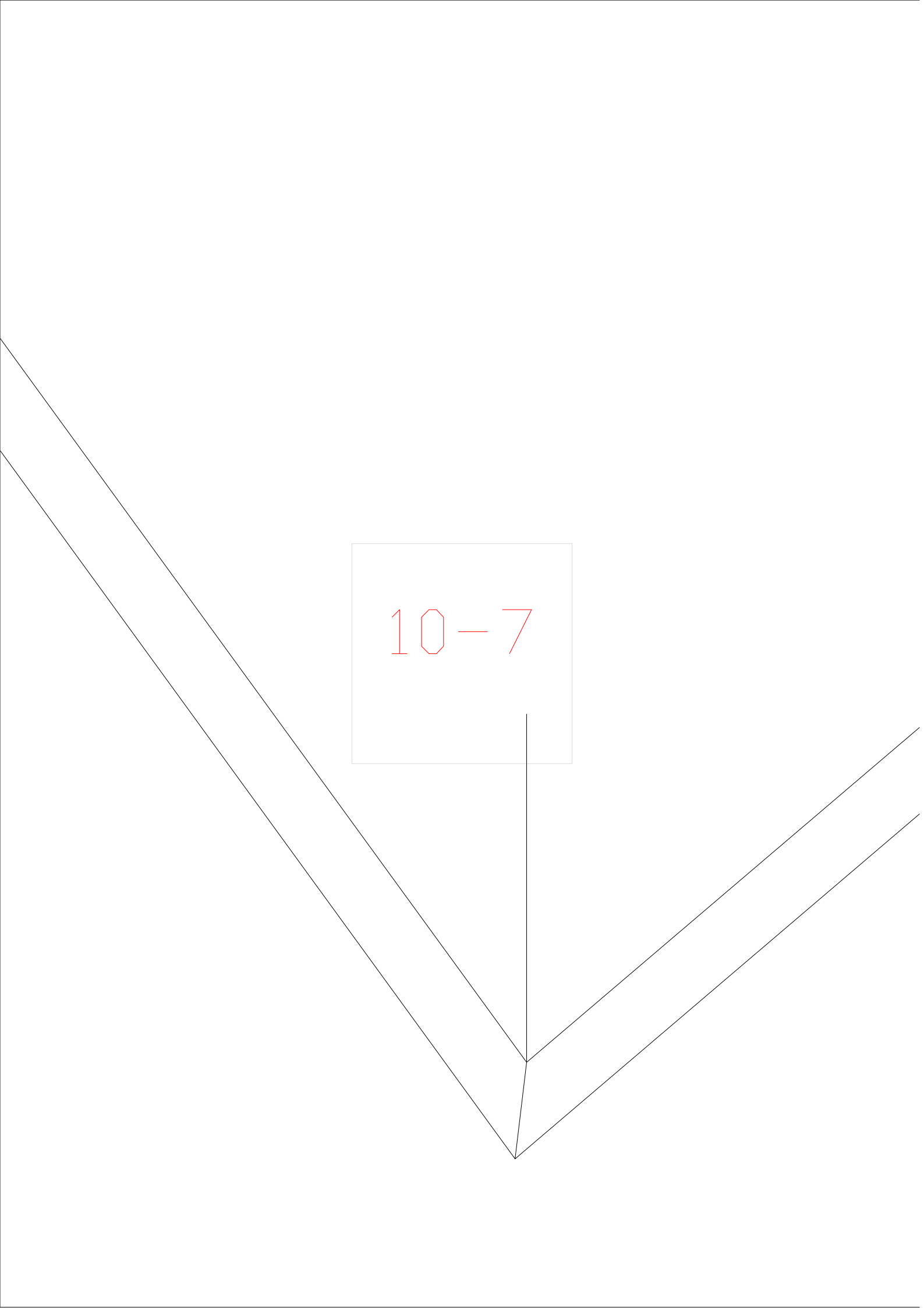

10-5

10-6

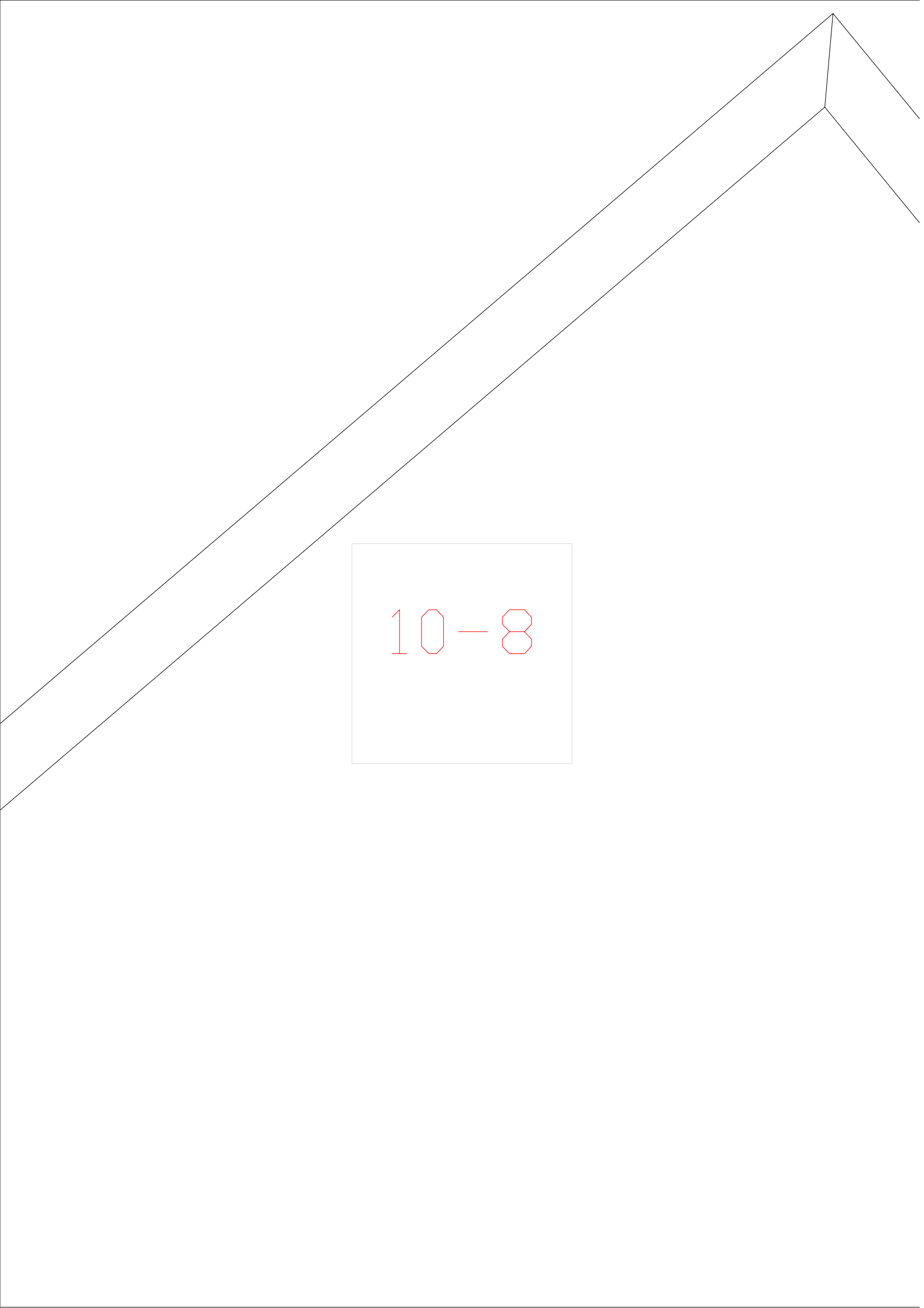
A diagram illustrating a V-shaped structure. The structure is formed by two lines meeting at a vertex at the bottom center. A vertical line extends upwards from this vertex. A rectangular box is positioned above the vertex, containing the equation $10 - 7$ in red text. The box is centered horizontally relative to the vertical line.
$$10 - 7$$

$$10 - 8$$

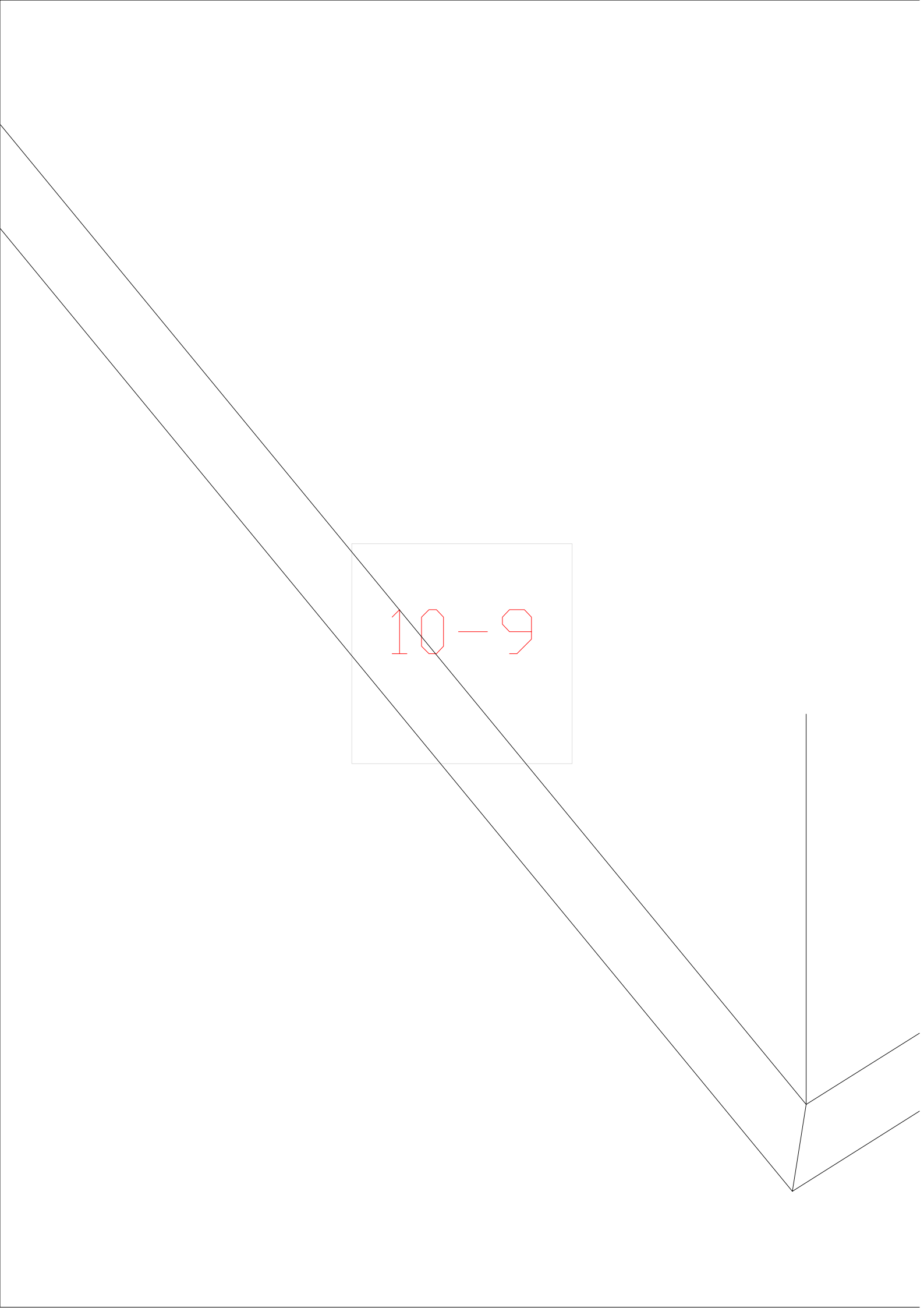

10-9

1-10

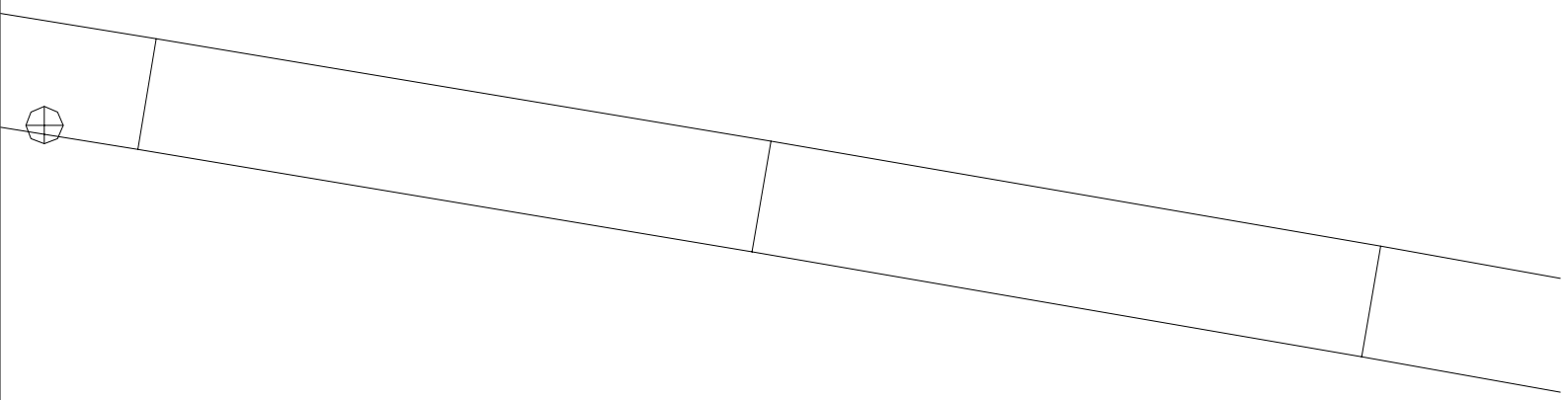

11-10

11 - 11

11-12

11-13

11-14

1-11



1-12

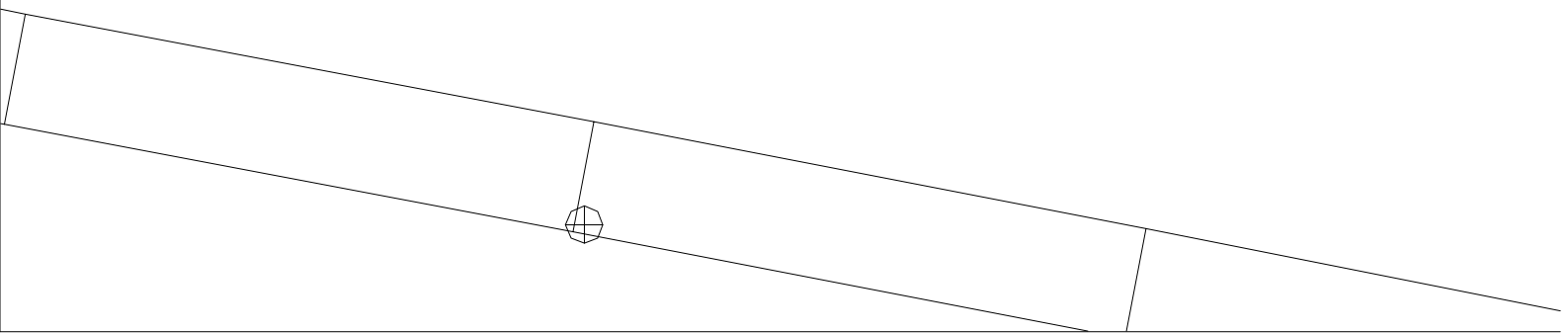

11-2

1-13

11-3

$$11 - 4$$

$$11 - 5$$

11-6

$$11 - 7$$

$$11 - 8$$

11-9

PRIMARY

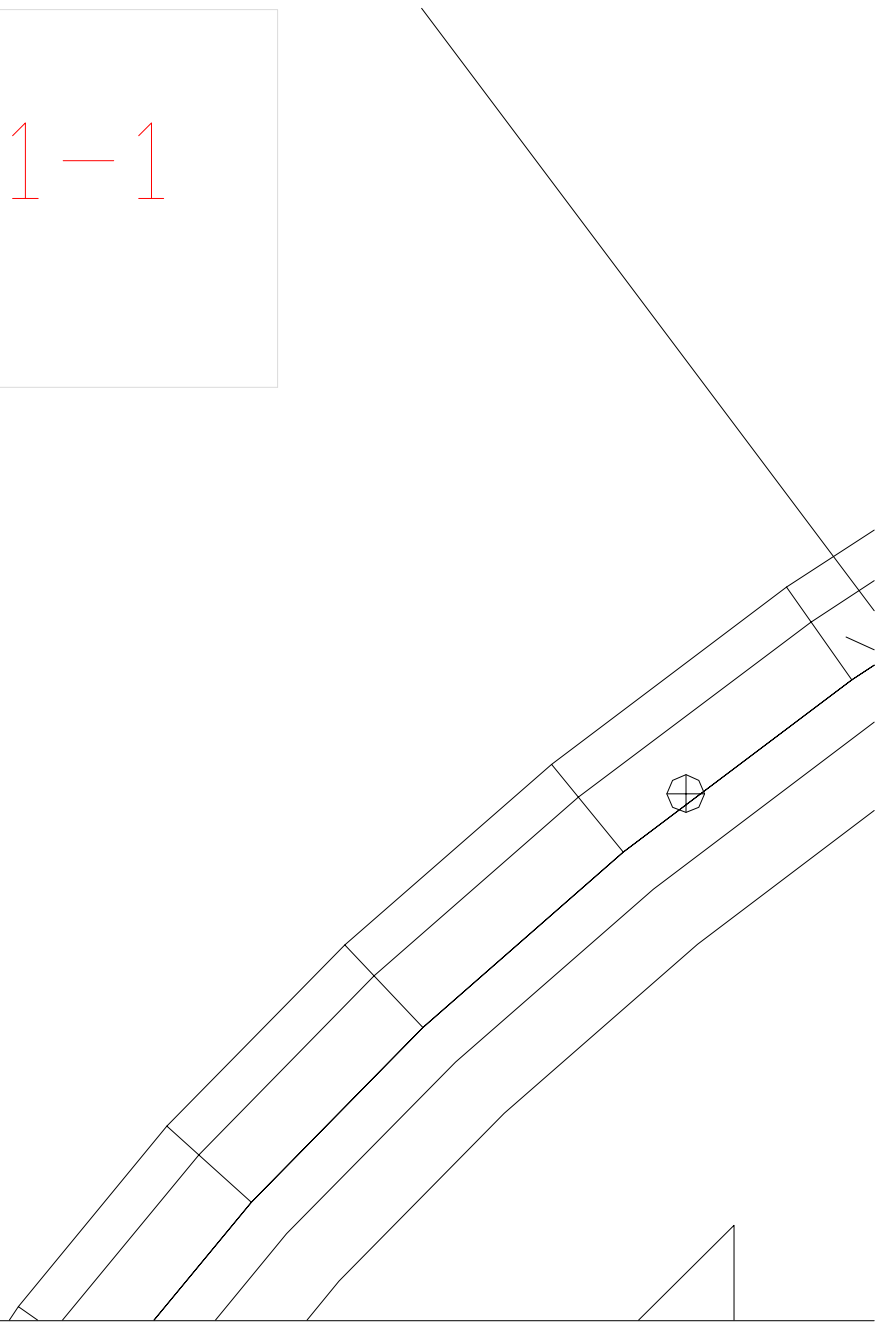
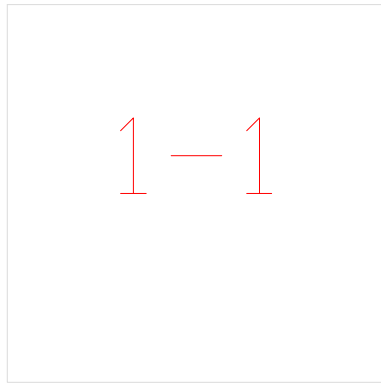

R O O D

1-2

S

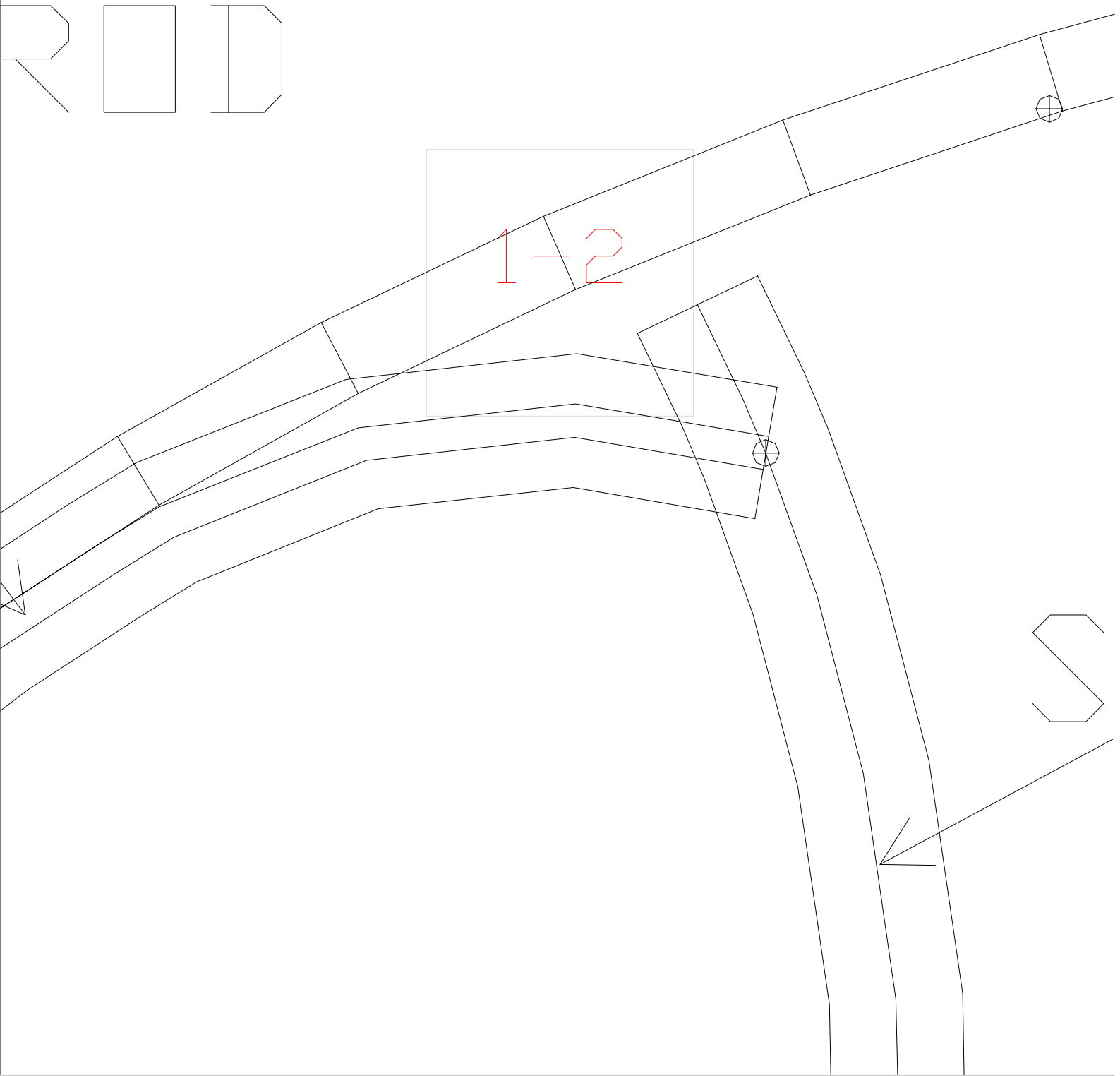

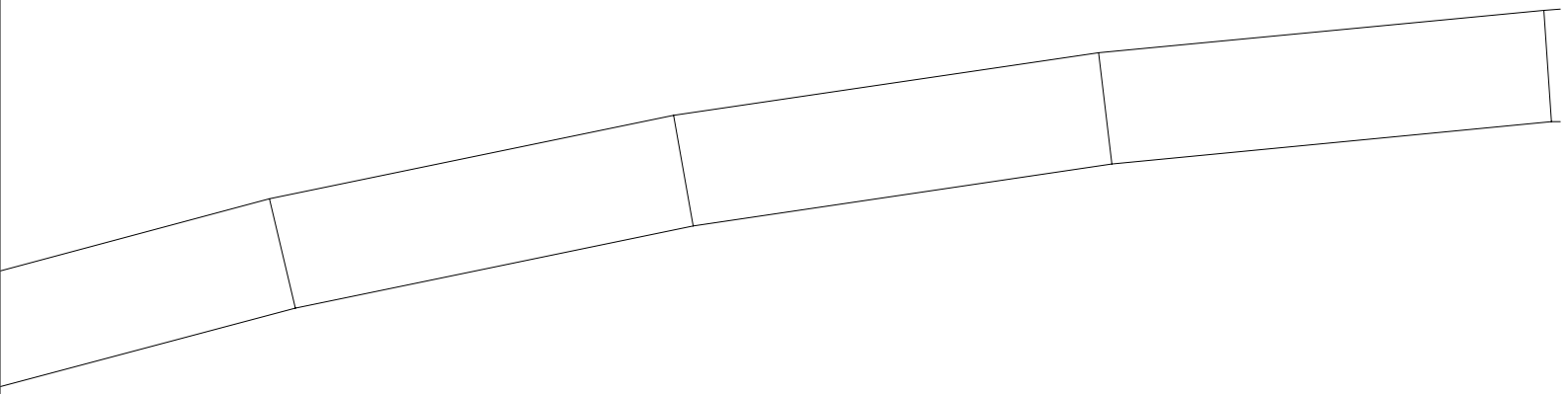

1-3

ECONDAARY RC



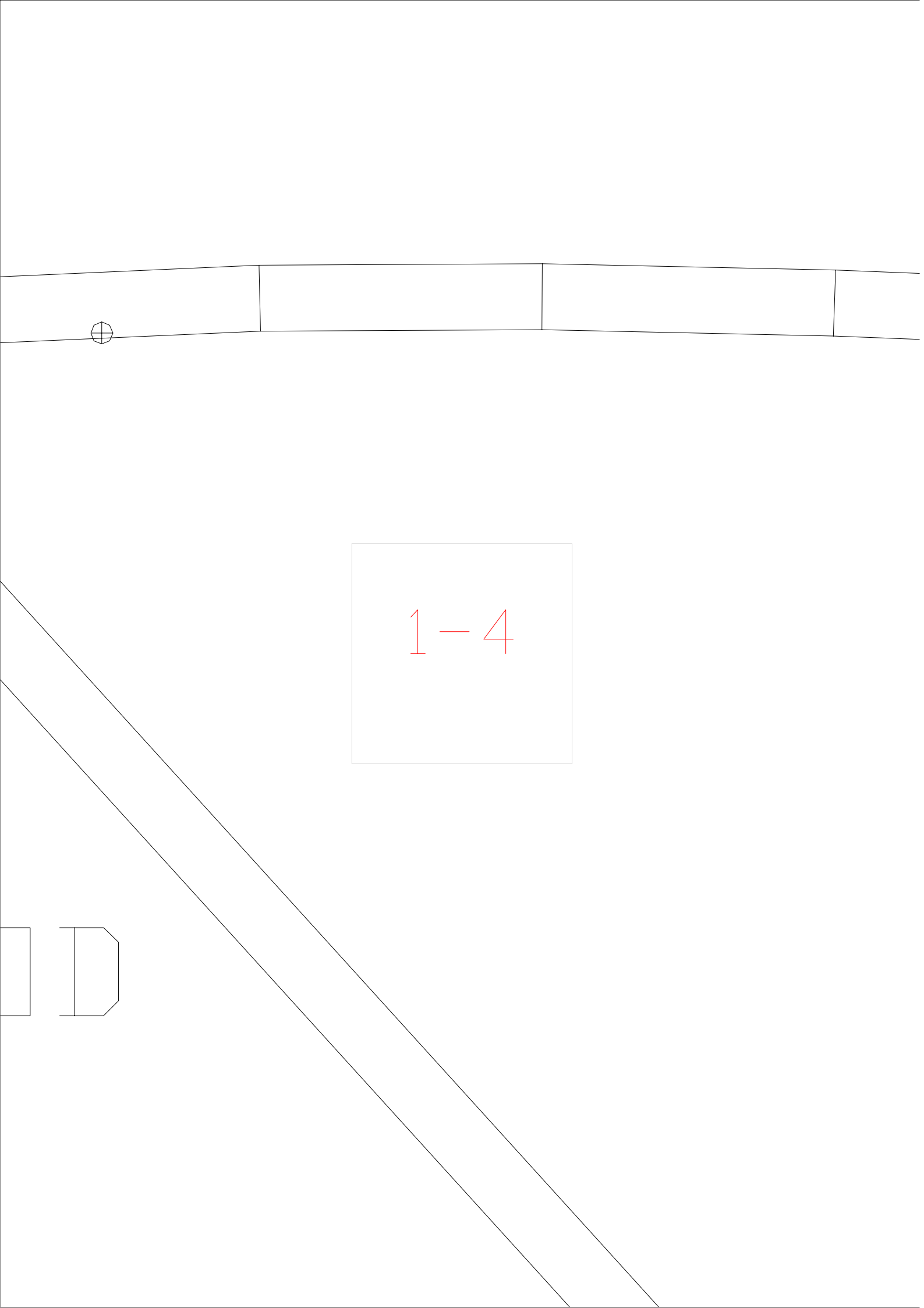

1-4

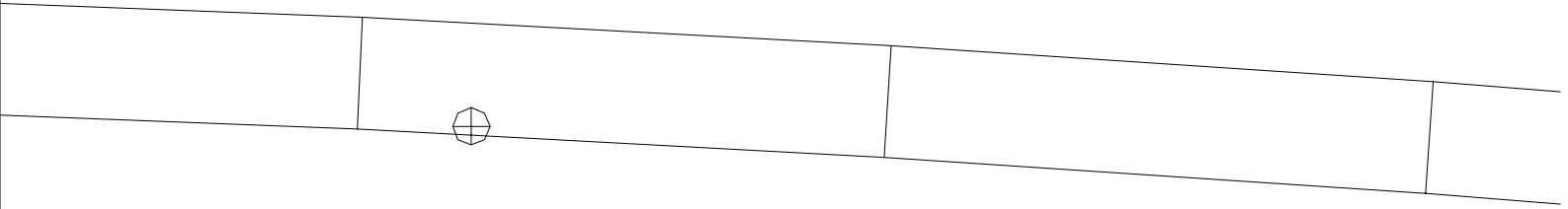

1-5

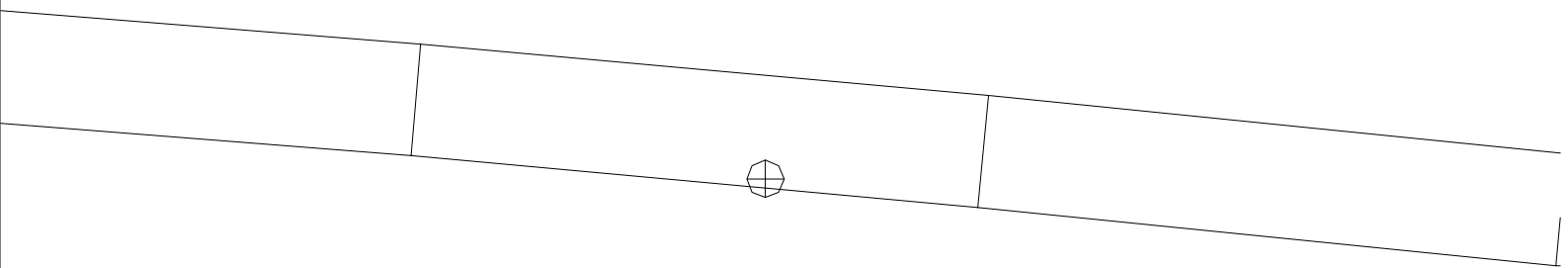

1-6

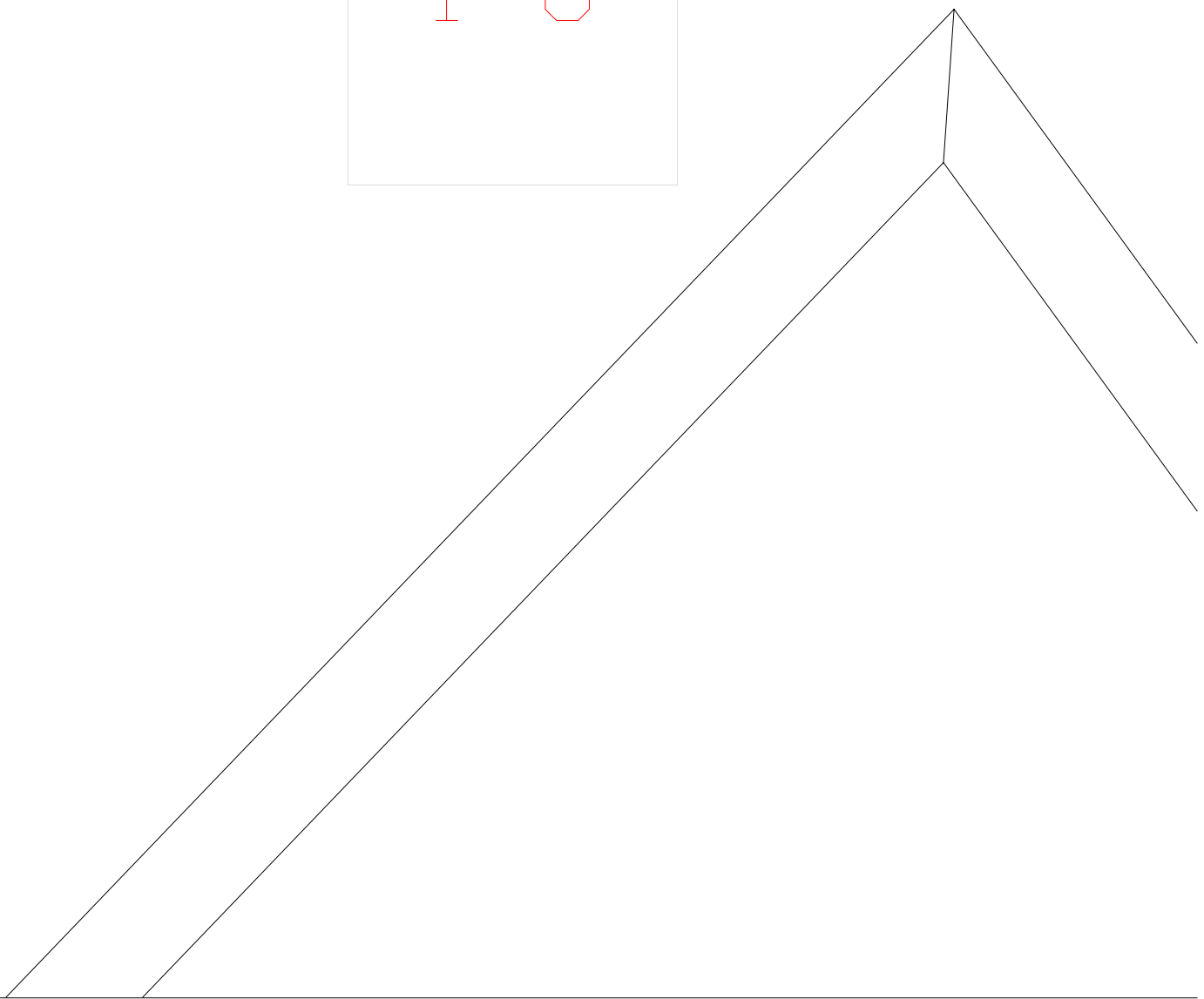

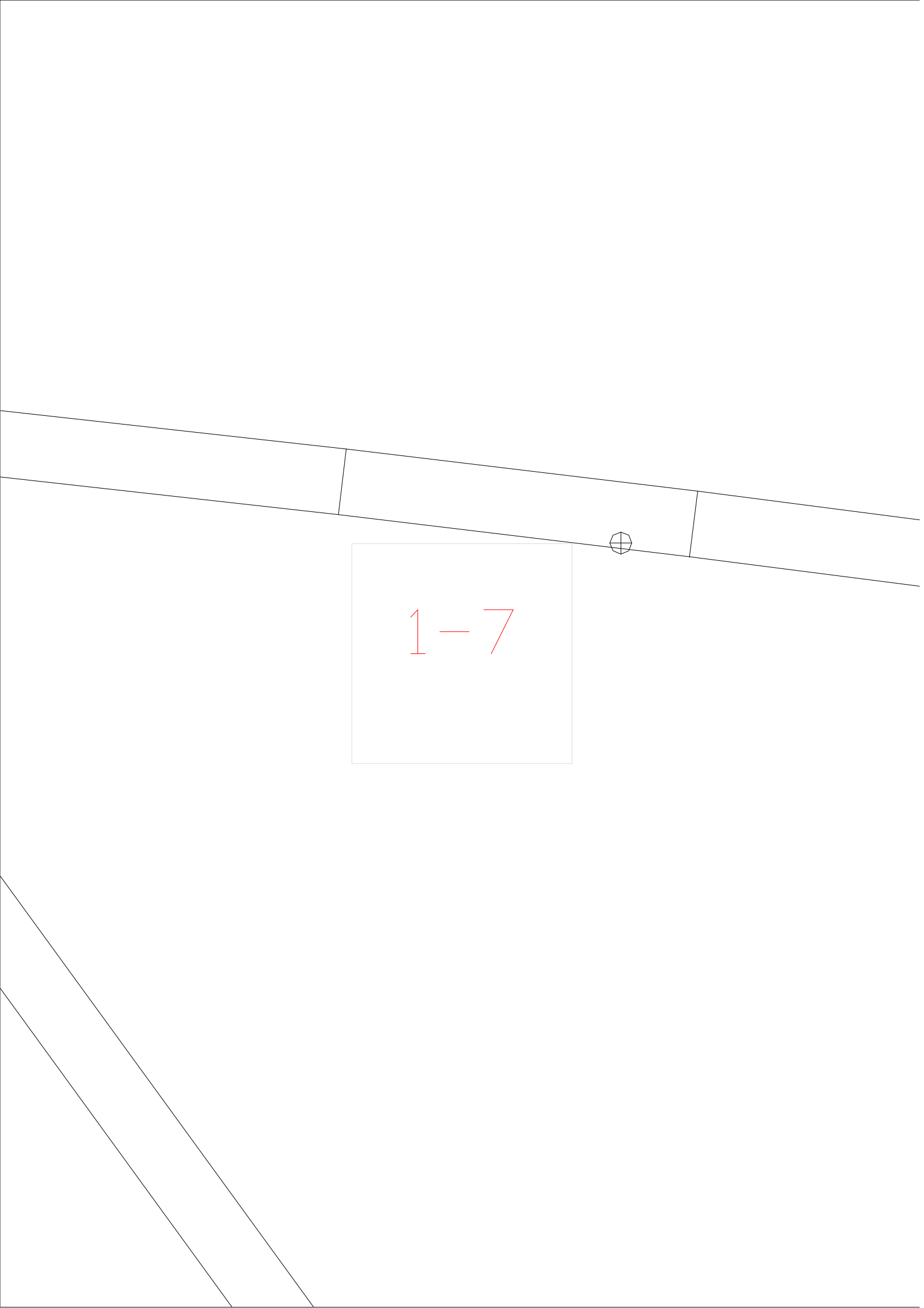

1-7

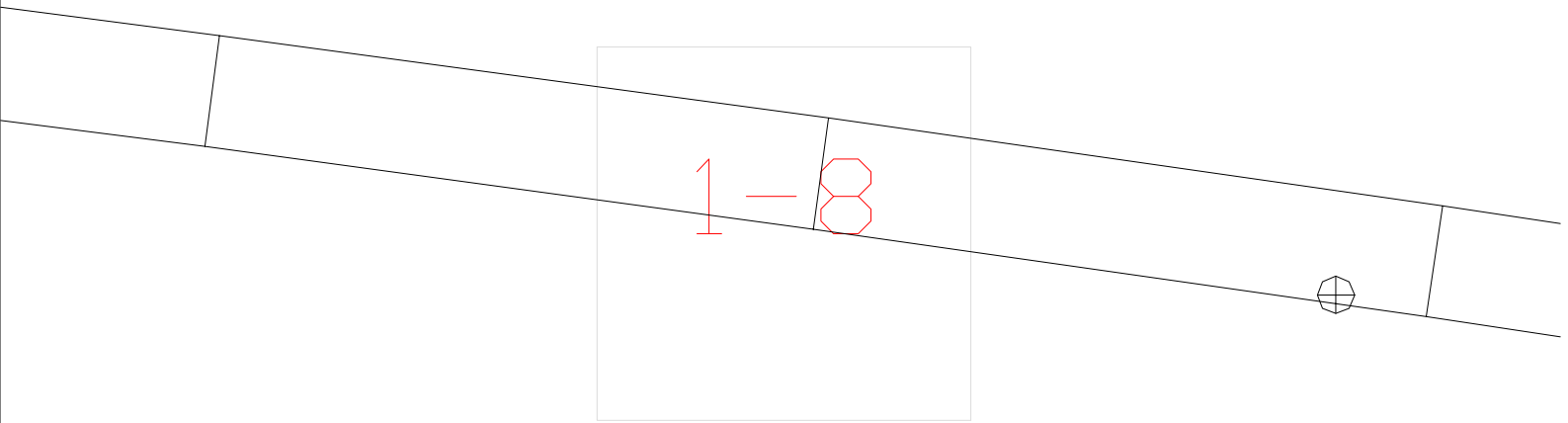

1-8



1-9

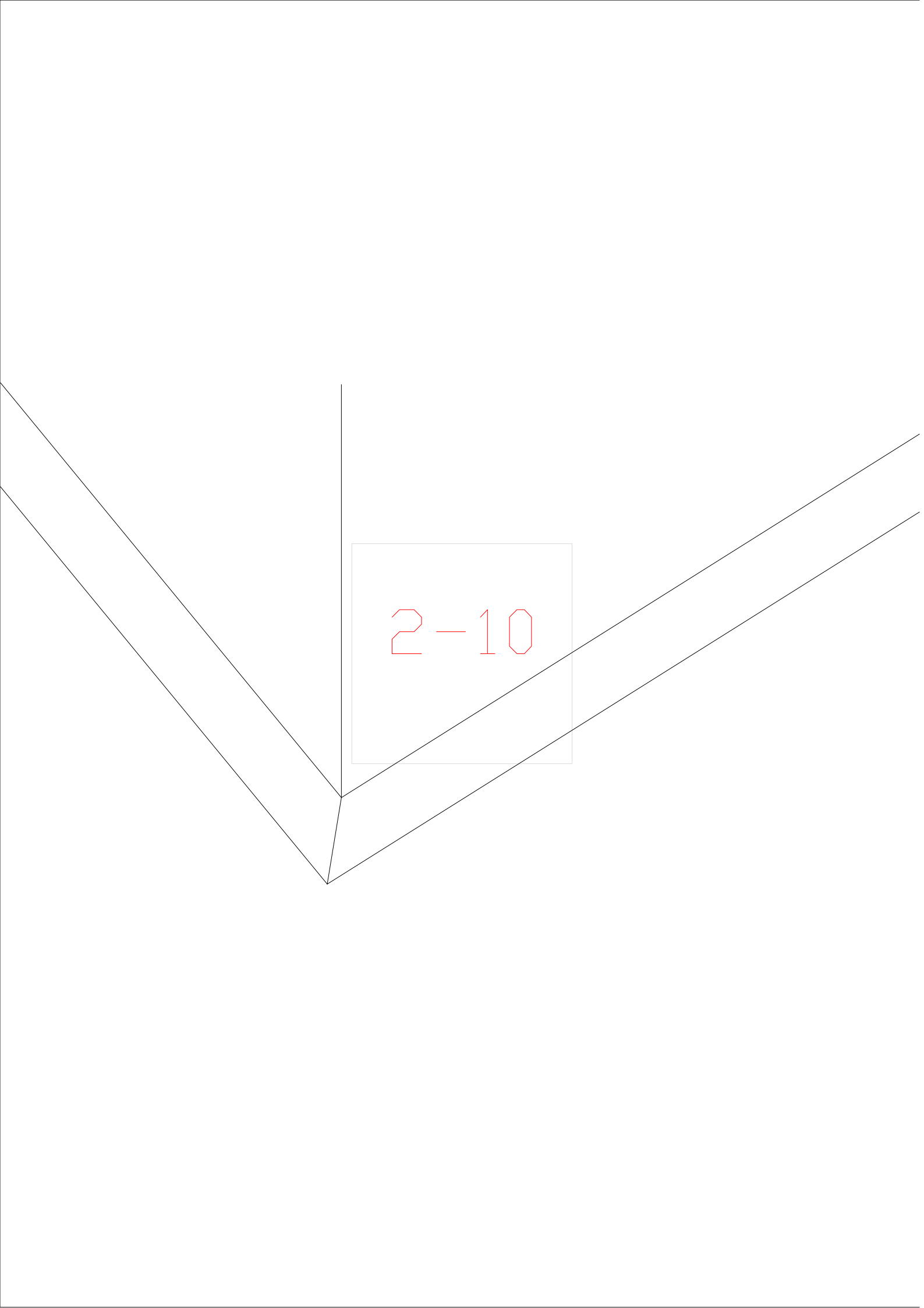

2-10

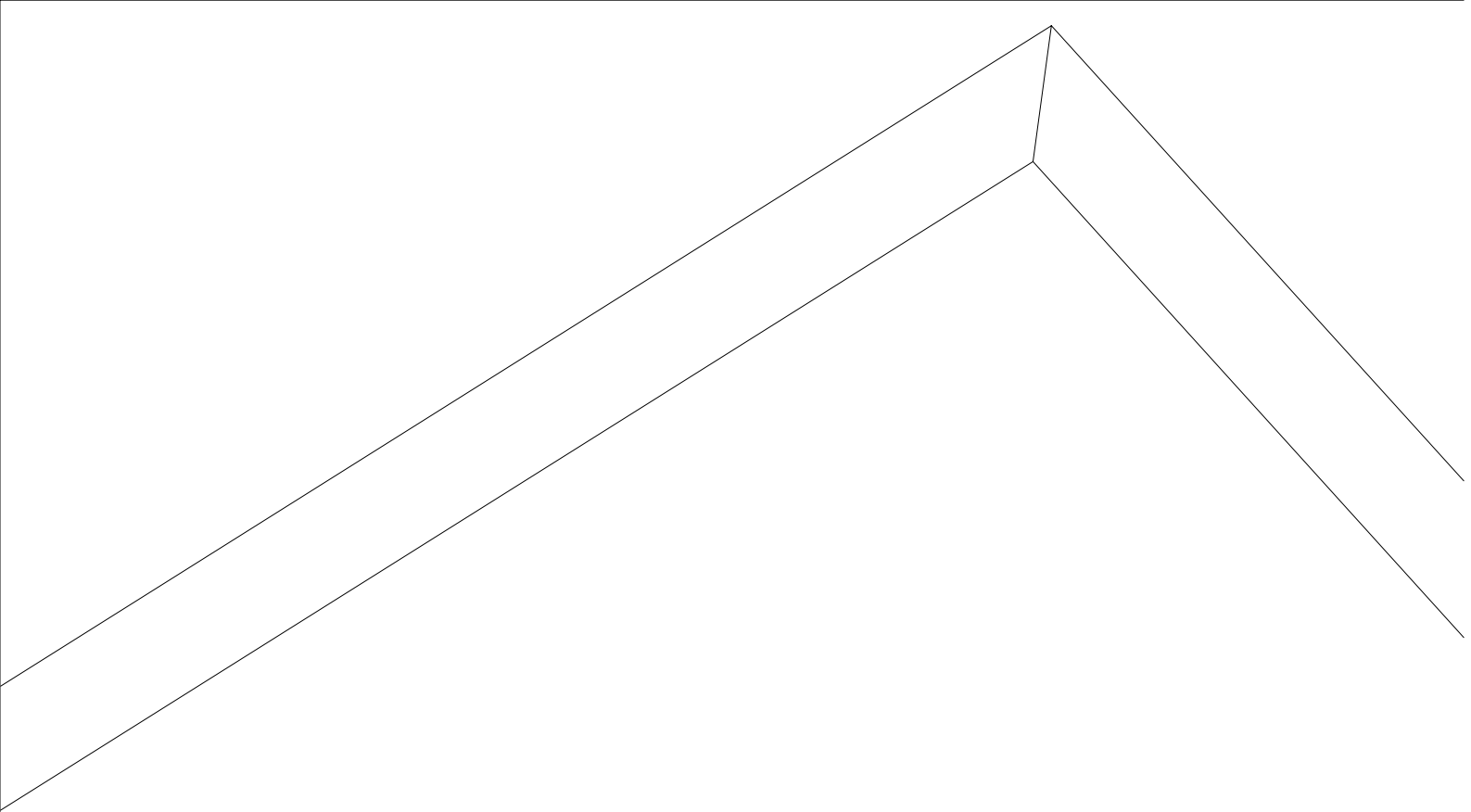

2-11

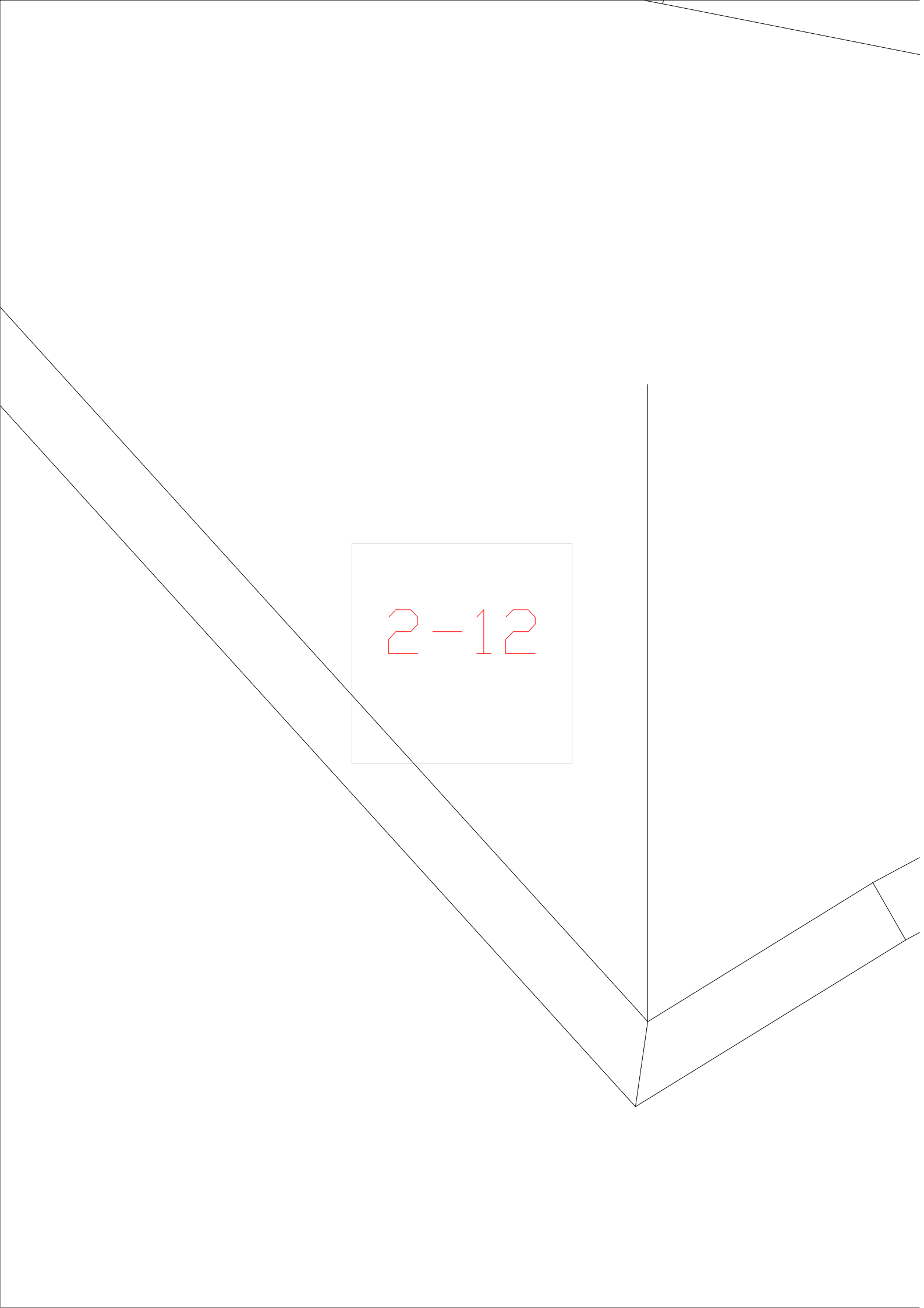

2-12

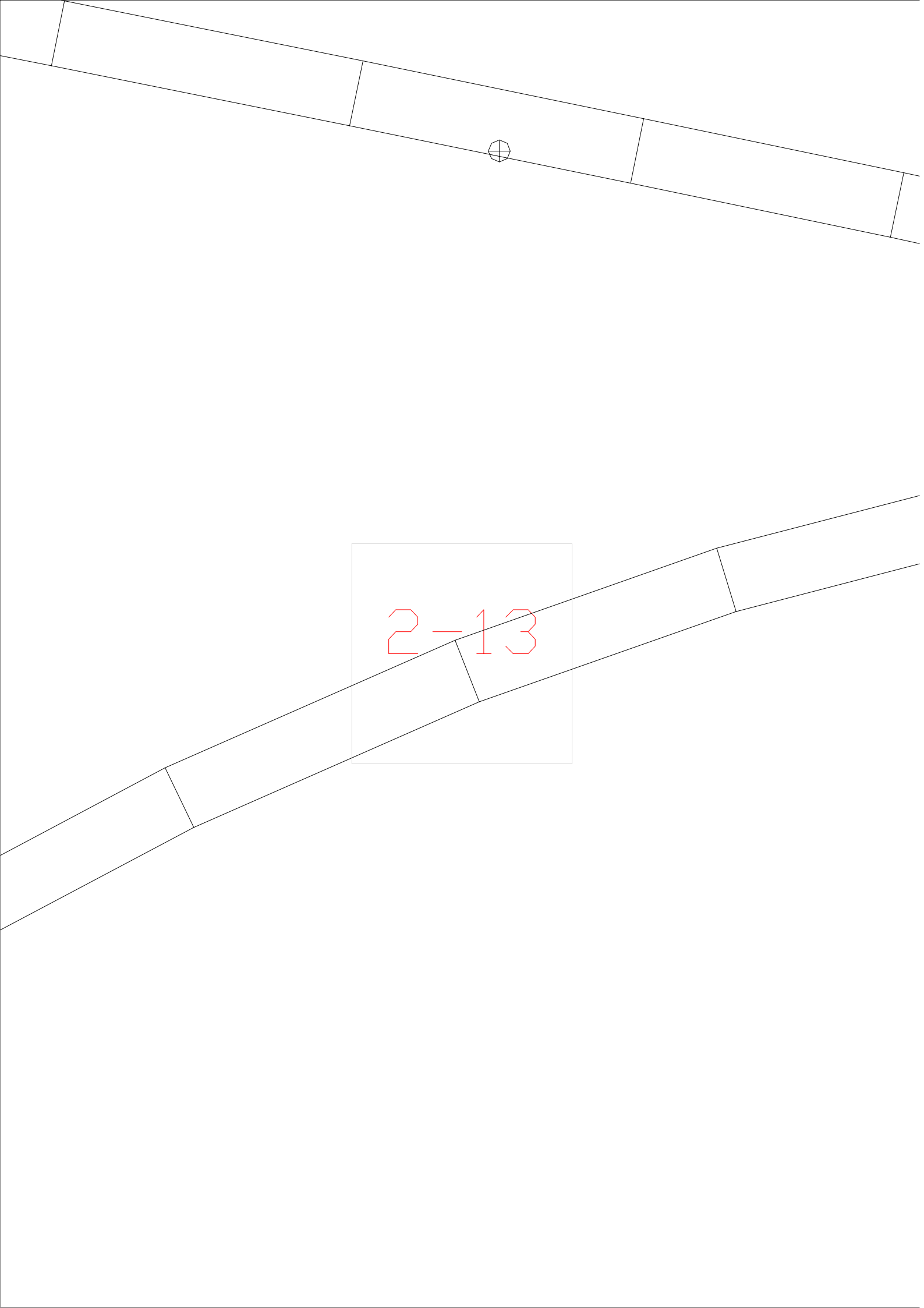

2-13

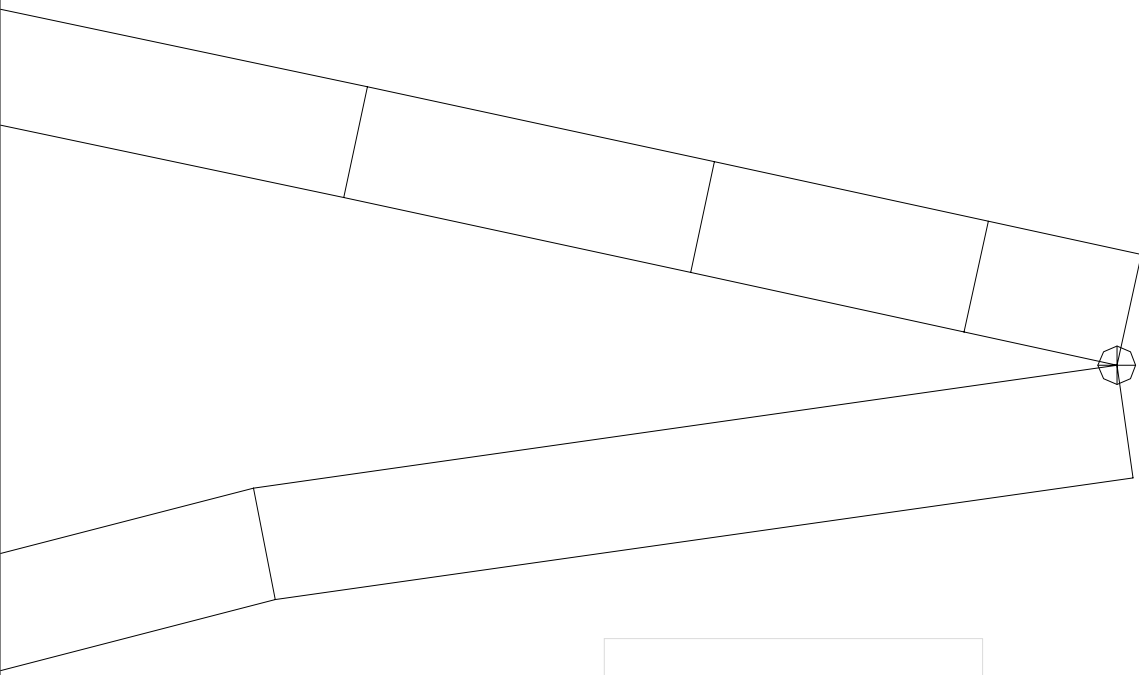

2-14

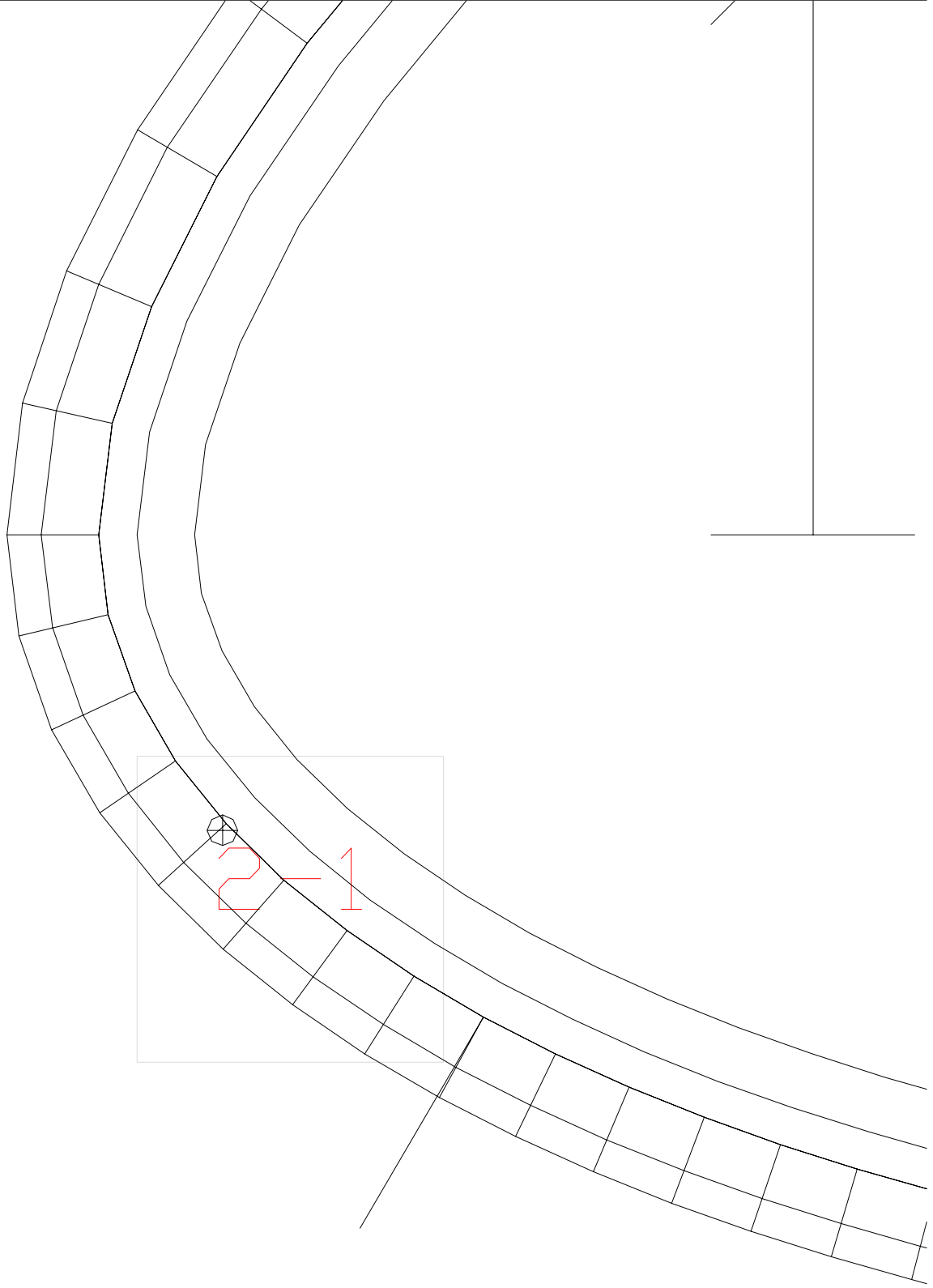

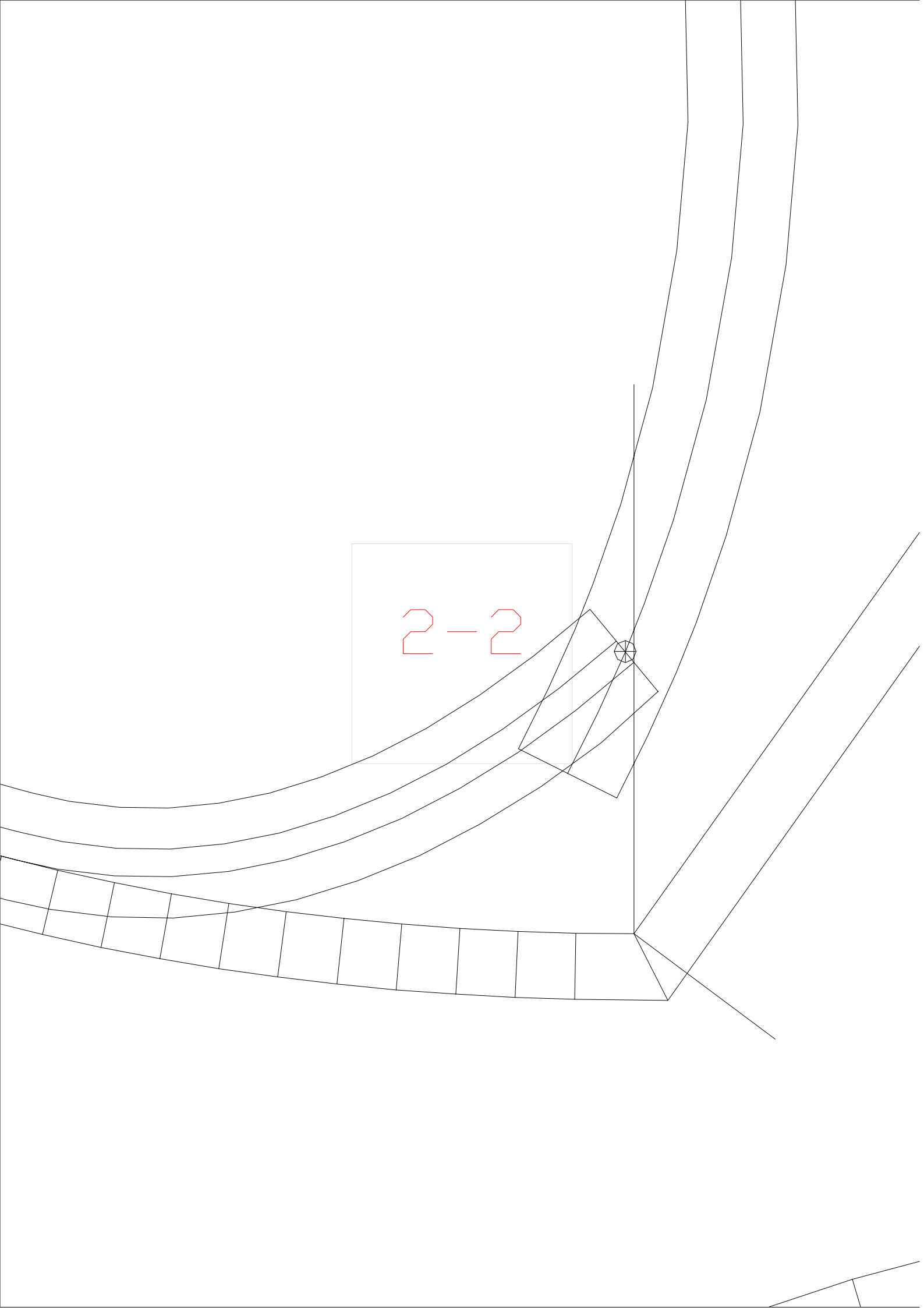

2-2



2-3

2-4



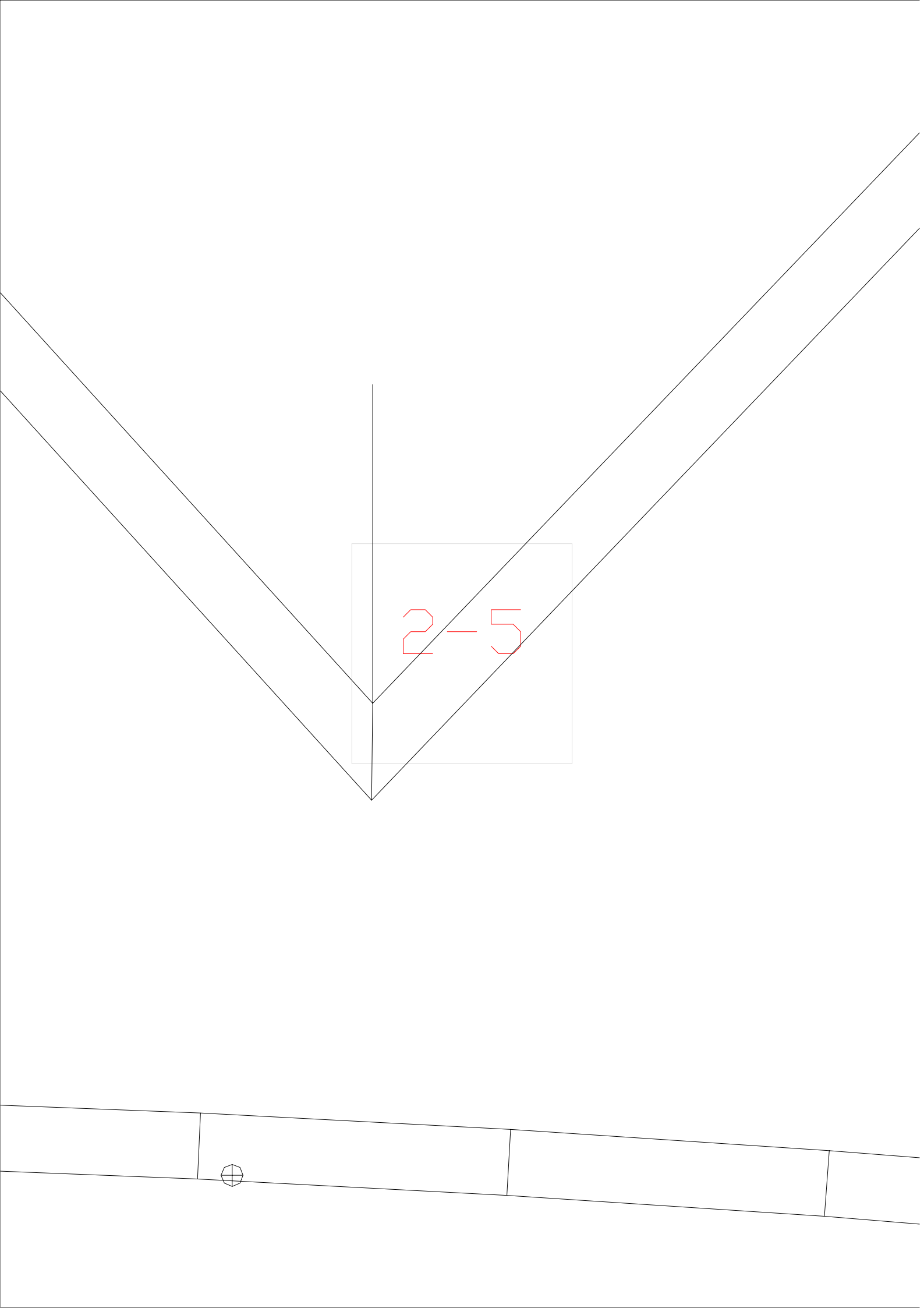

2-5



2-6



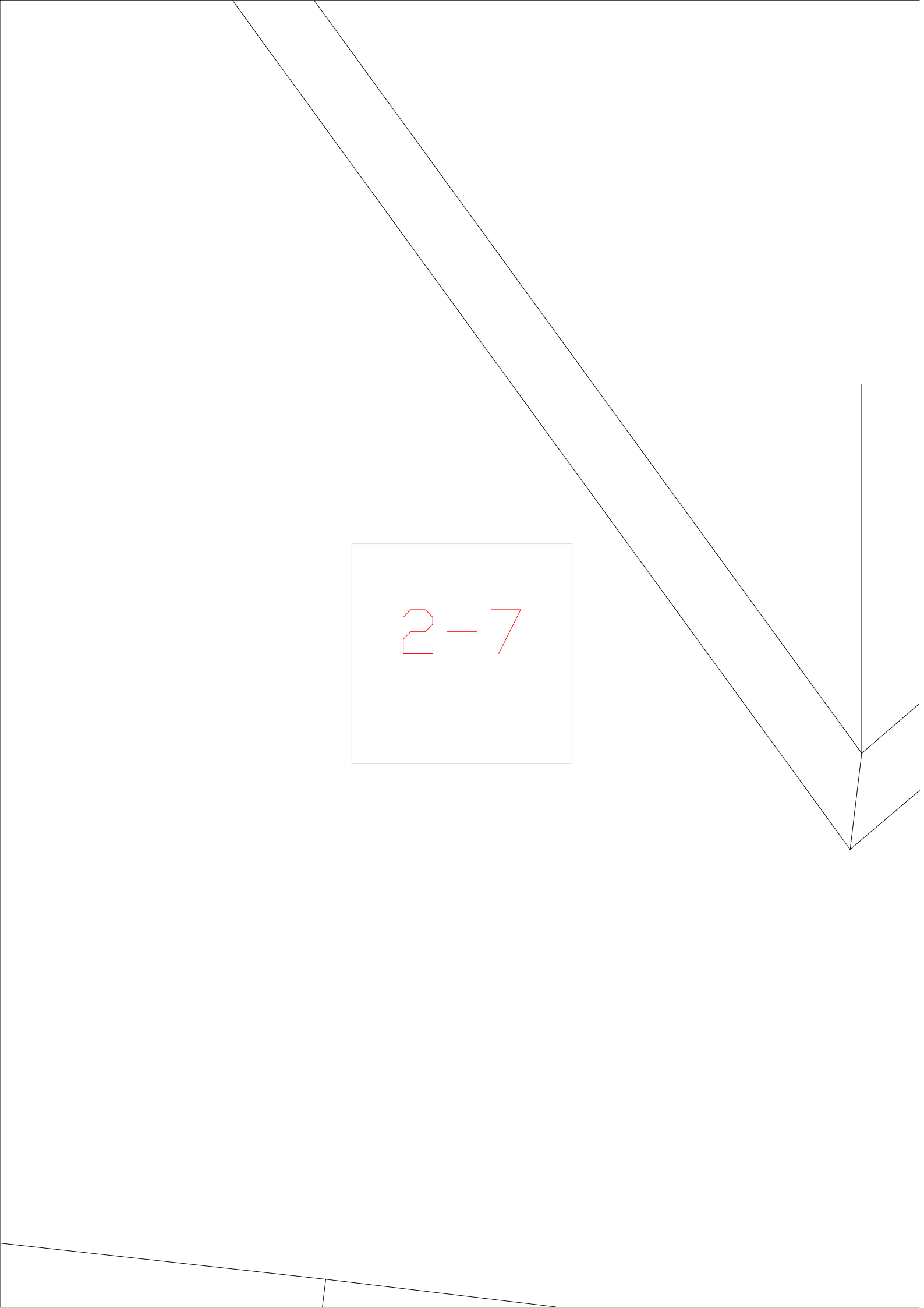

2-7

A diagram showing a rectangular area with a diagonal line running from the top-left to the bottom-right. A light blue box is positioned in the lower-right quadrant of the area, containing the number 28 in red. The number 2 is on the left, followed by a minus sign, and the number 8 is on the right.

2-8



2-9

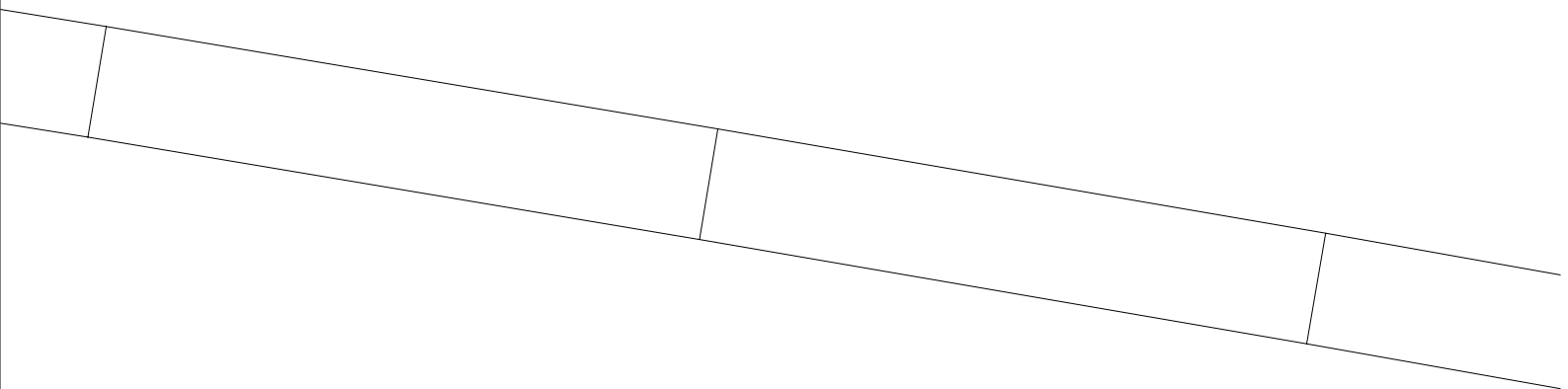

3-10

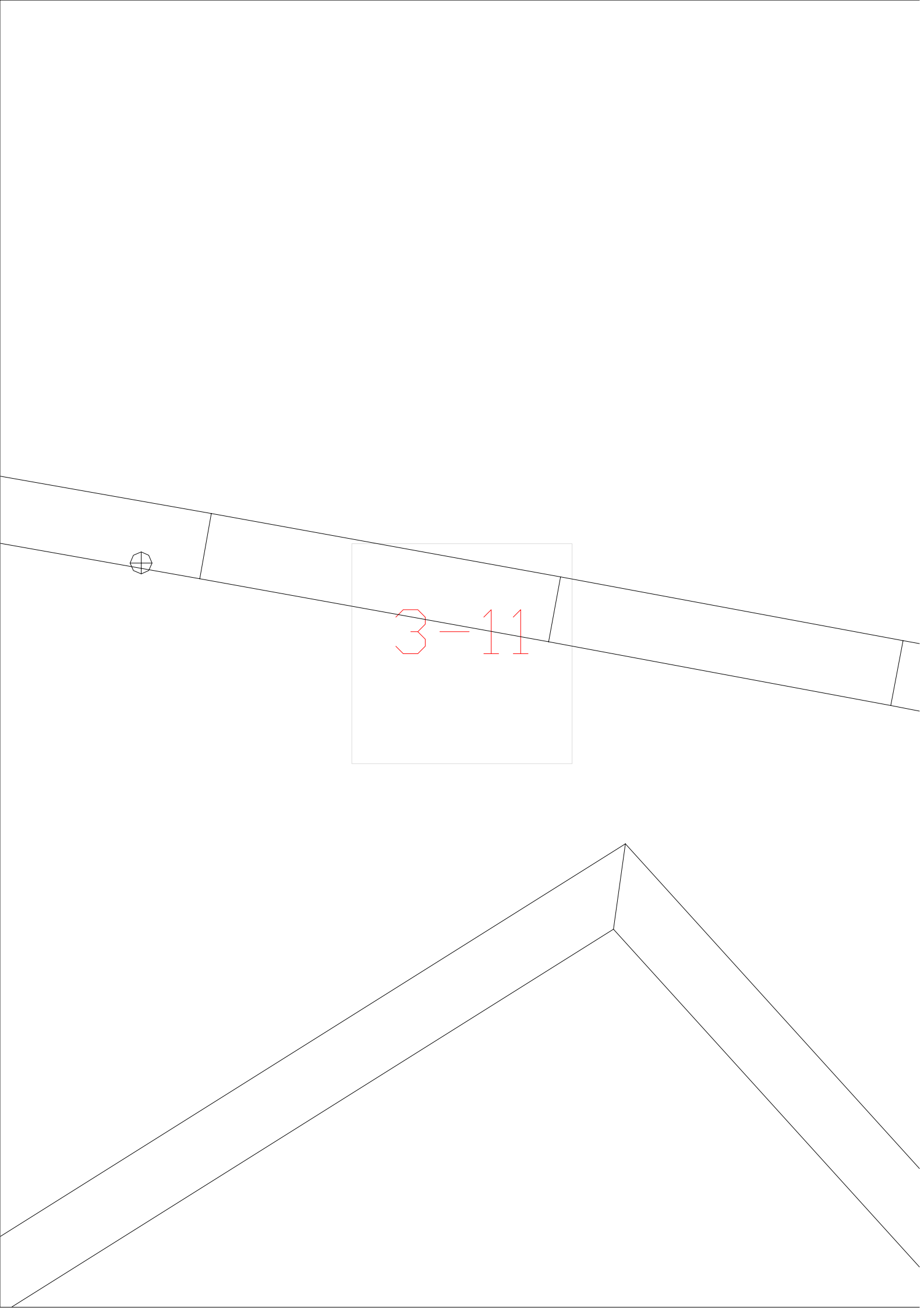

3-11

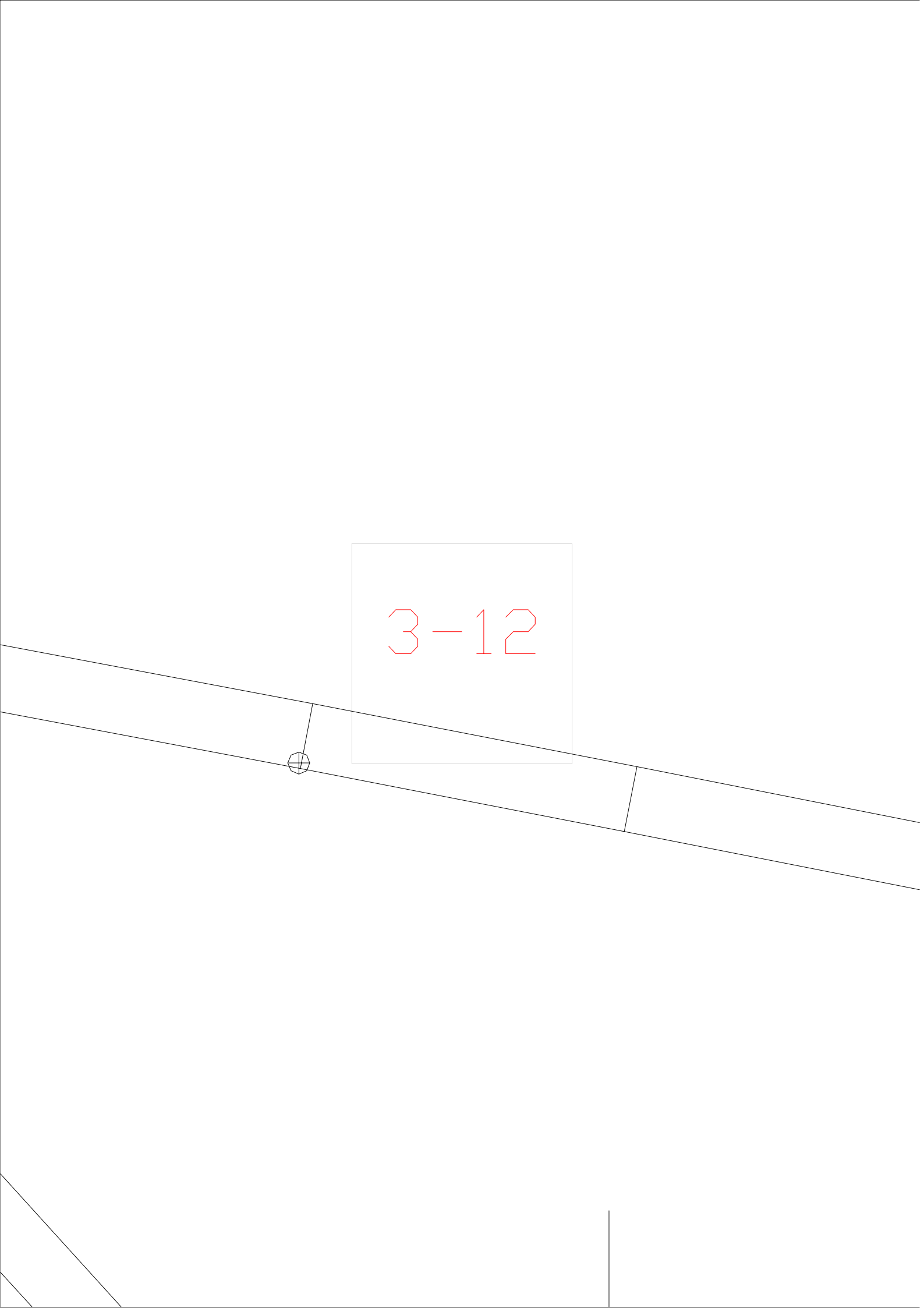

3-12

The image shows a technical drawing of a tapered shaft. The shaft is represented by two parallel lines that converge from left to right. A circular hole is shown on the shaft, with a vertical line extending from its center to a rectangular callout box. The callout box contains the text '3-12' in red. The drawing is set against a white background with a light gray grid.

3-13

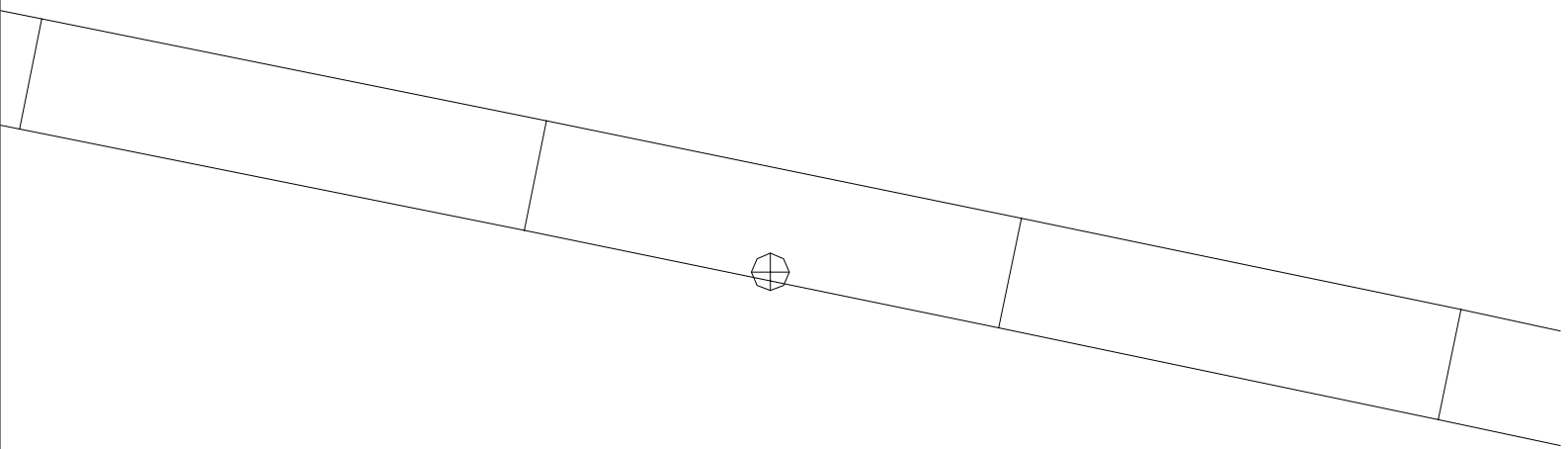

3-14

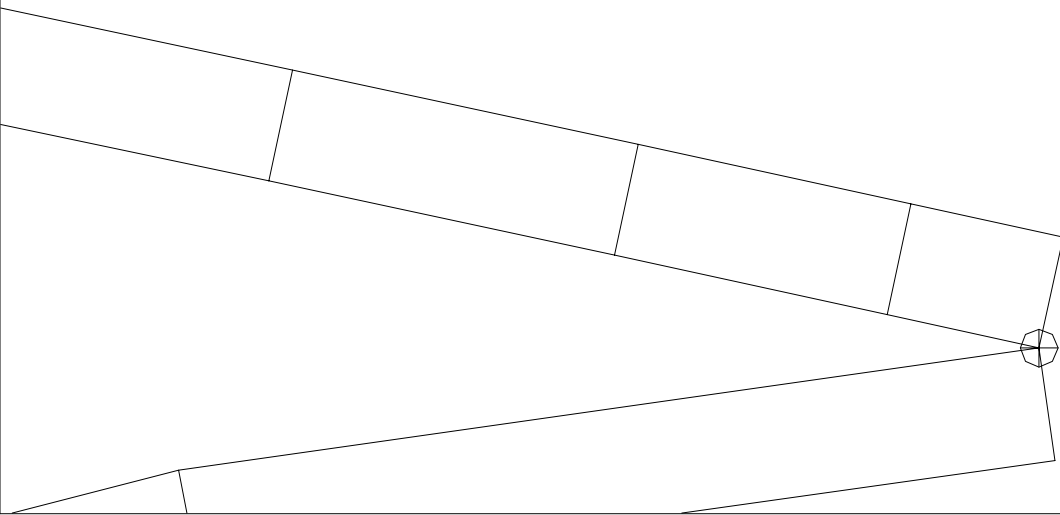

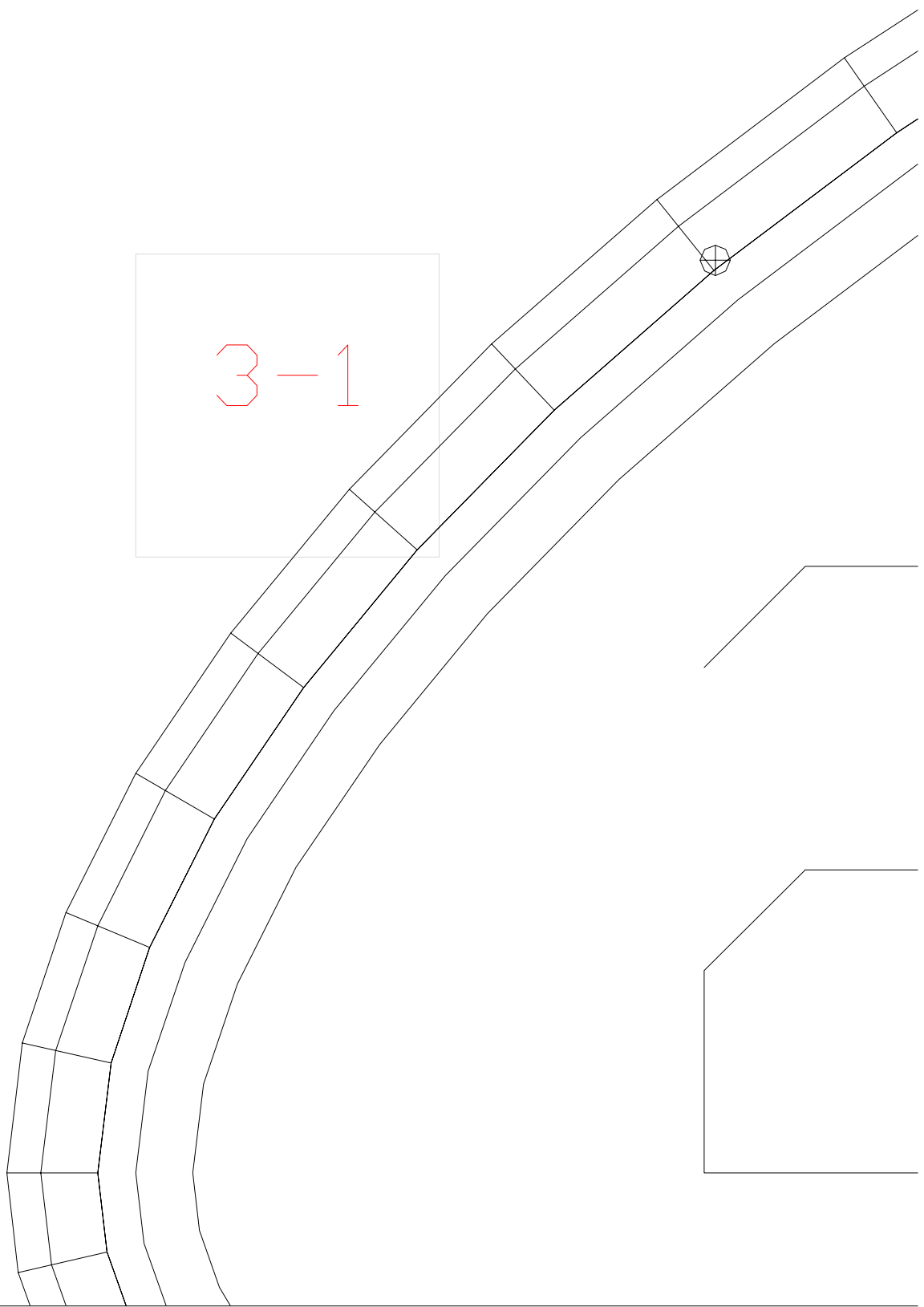

3-1

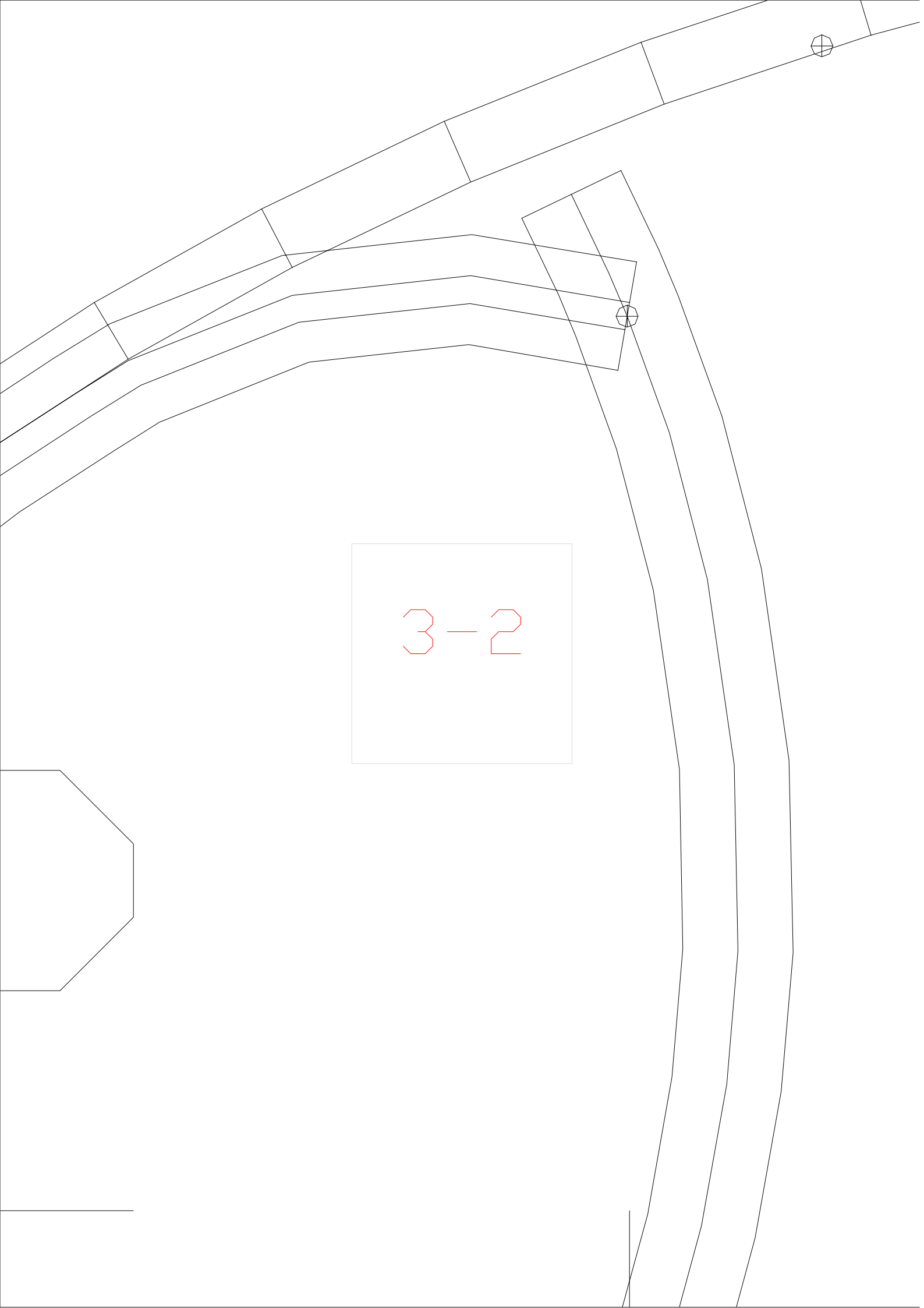

3-2

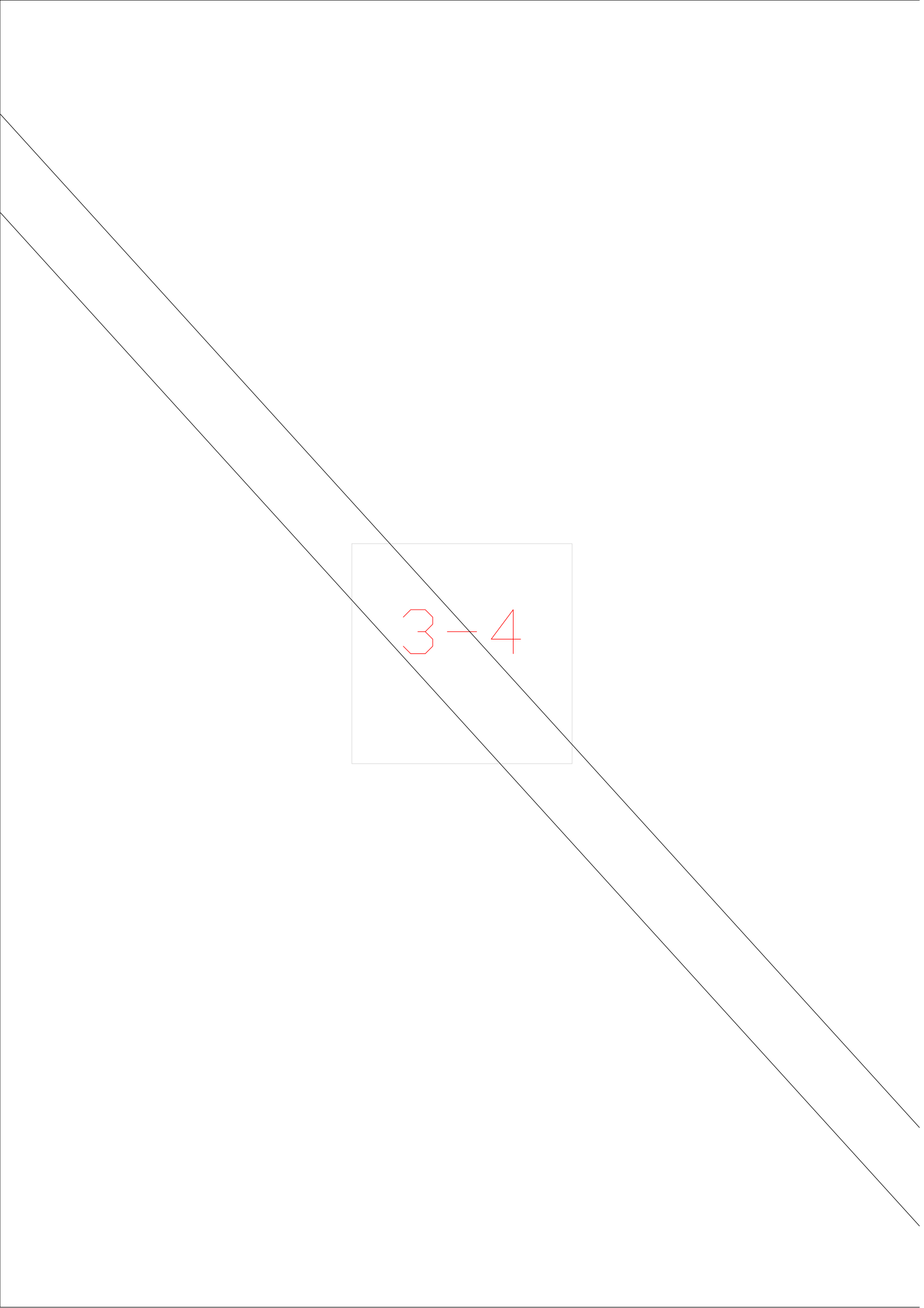

3-3

A diagram consisting of a rectangular area with a diagonal line running from the top-left to the bottom-right. The diagonal line is drawn with two parallel lines, creating a narrow channel. Inside the rectangular area, the text "3-4" is written in red. The number "3" is on the left, followed by a horizontal line, and the number "4" is on the right. The entire diagram is set against a white background.

3-4

3-5

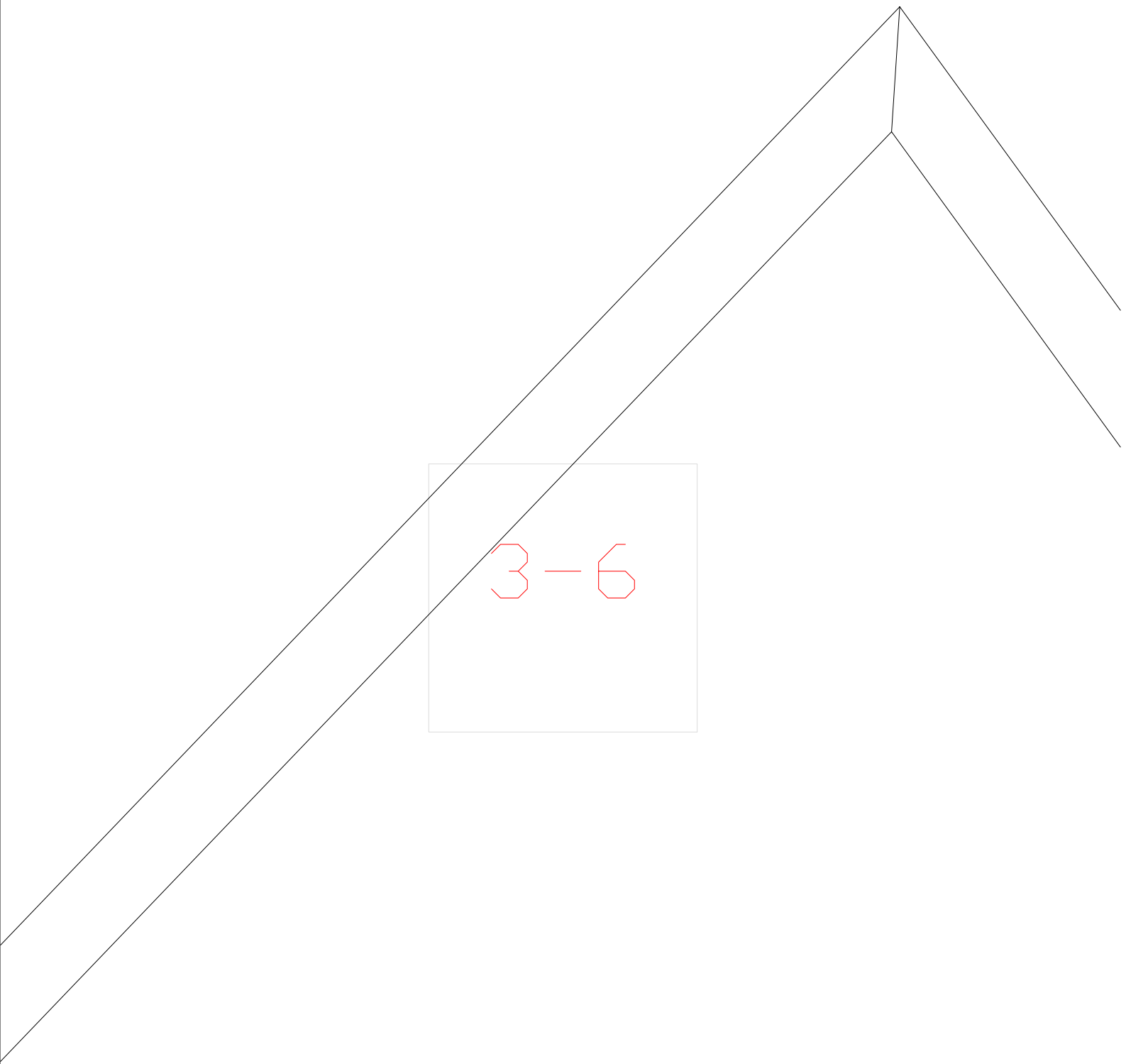

3-6



3-7

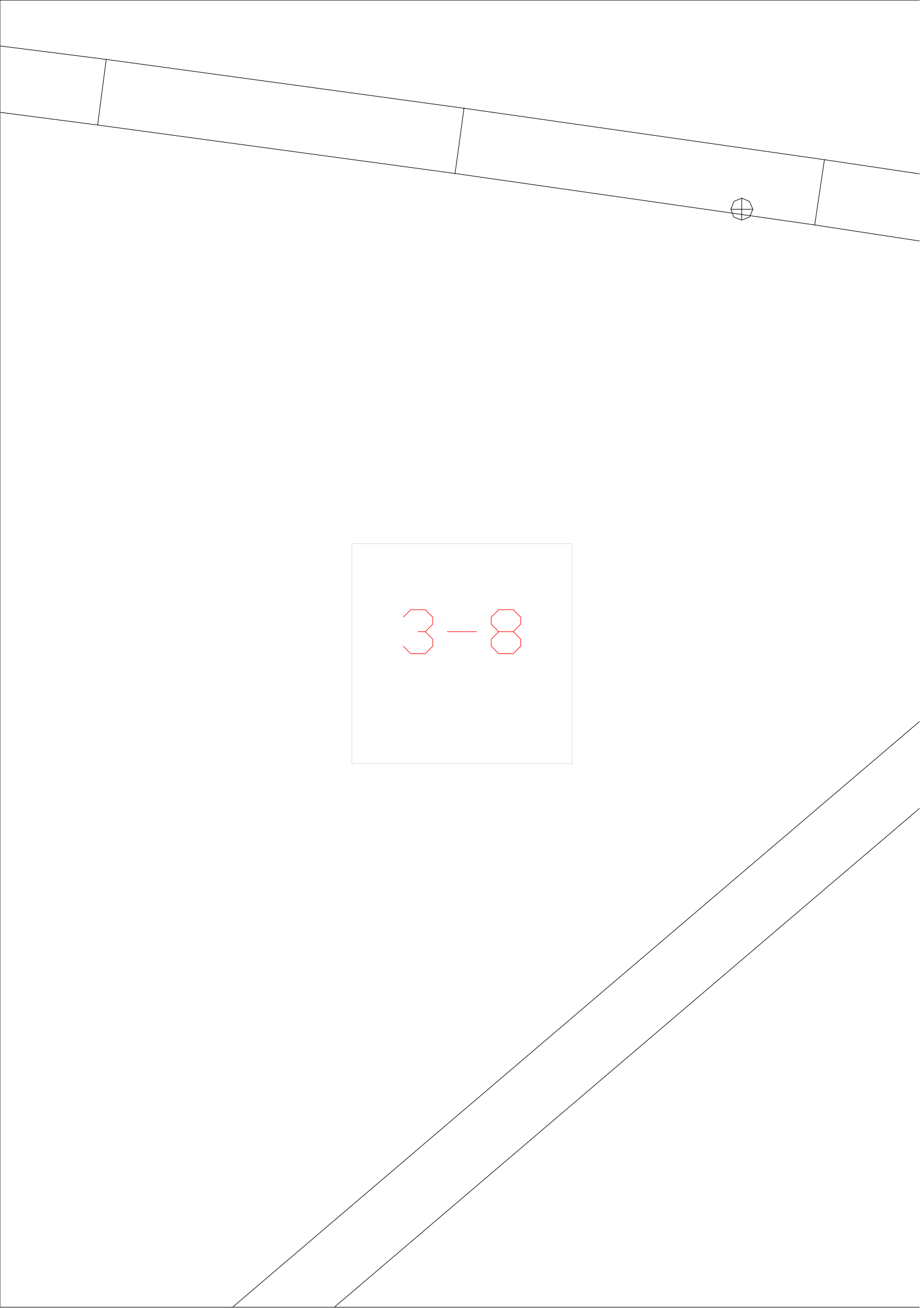

3-8

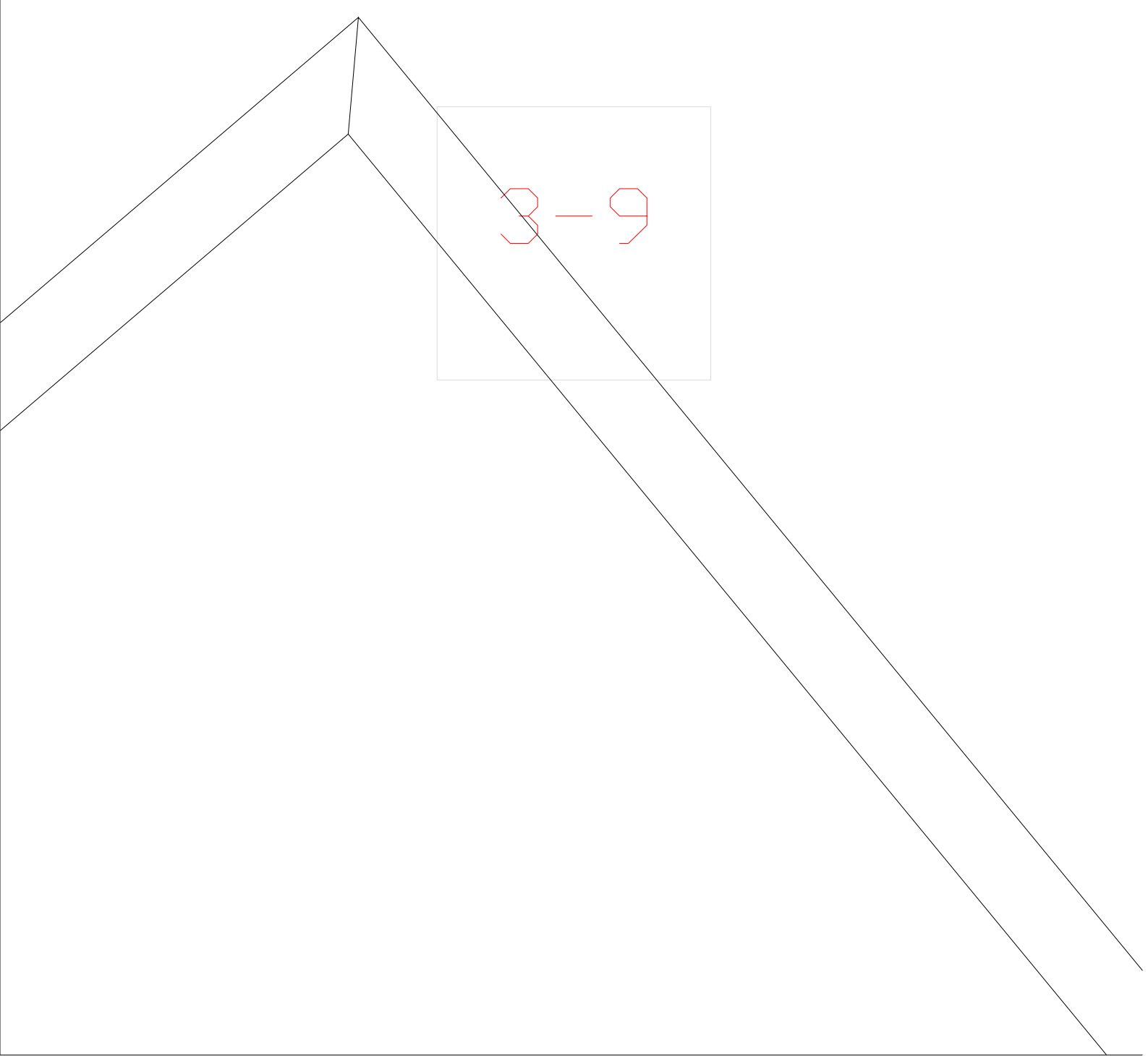
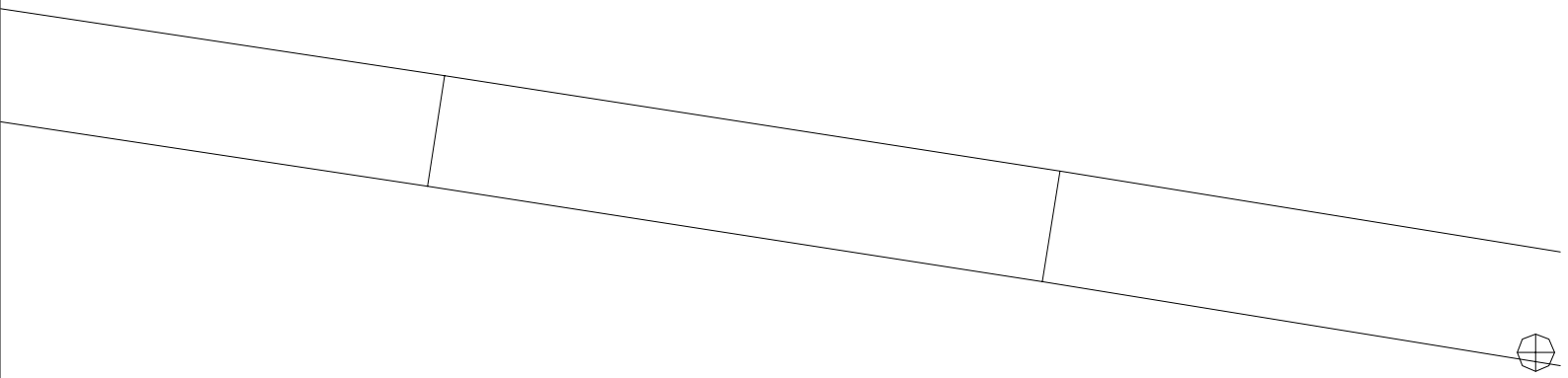

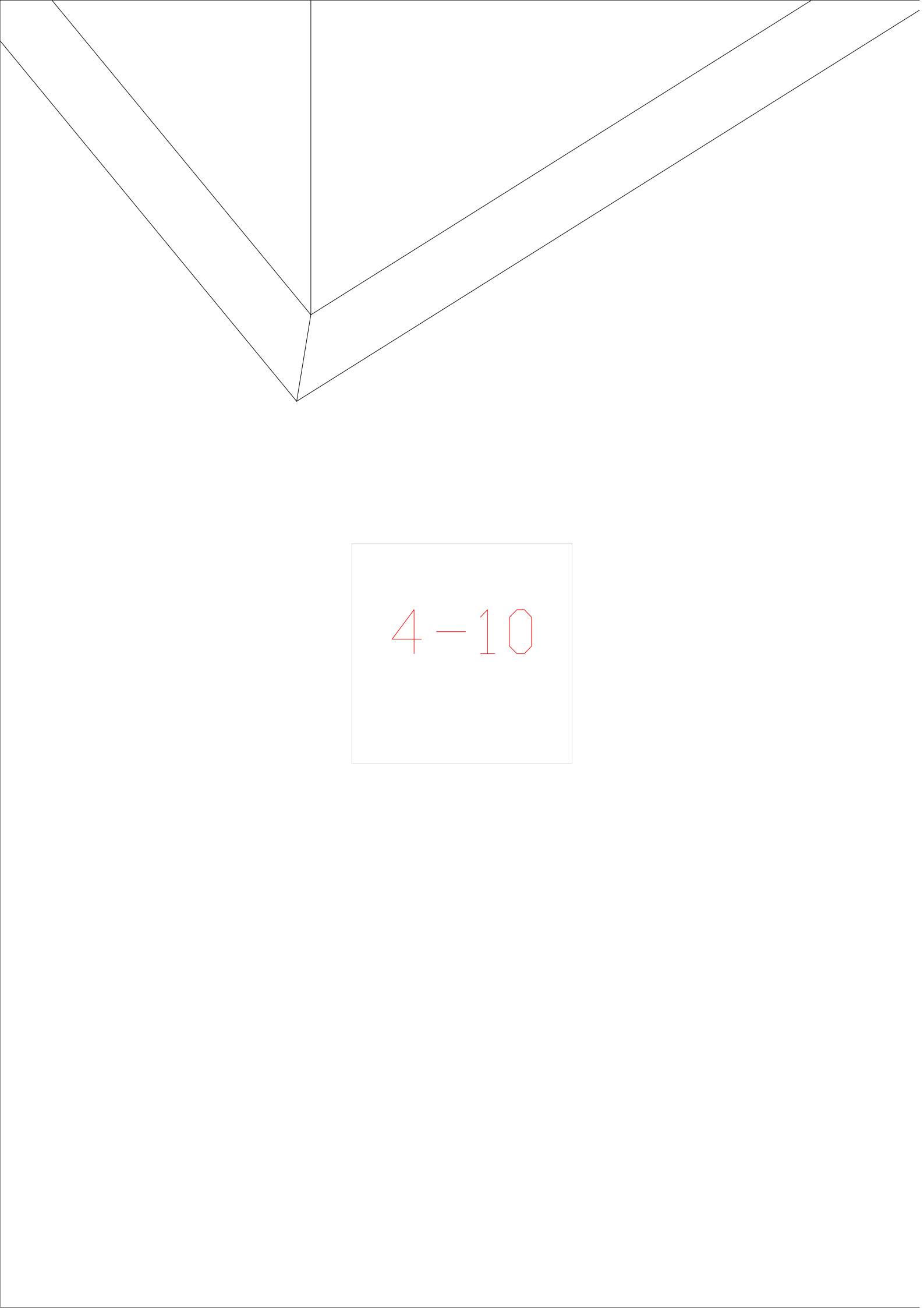

A diagram showing a V-shaped notch. A vertical line descends from the top center of the notch. A rectangular box is positioned below the notch, containing the text "4-10".

4-10

$$4 - 11$$

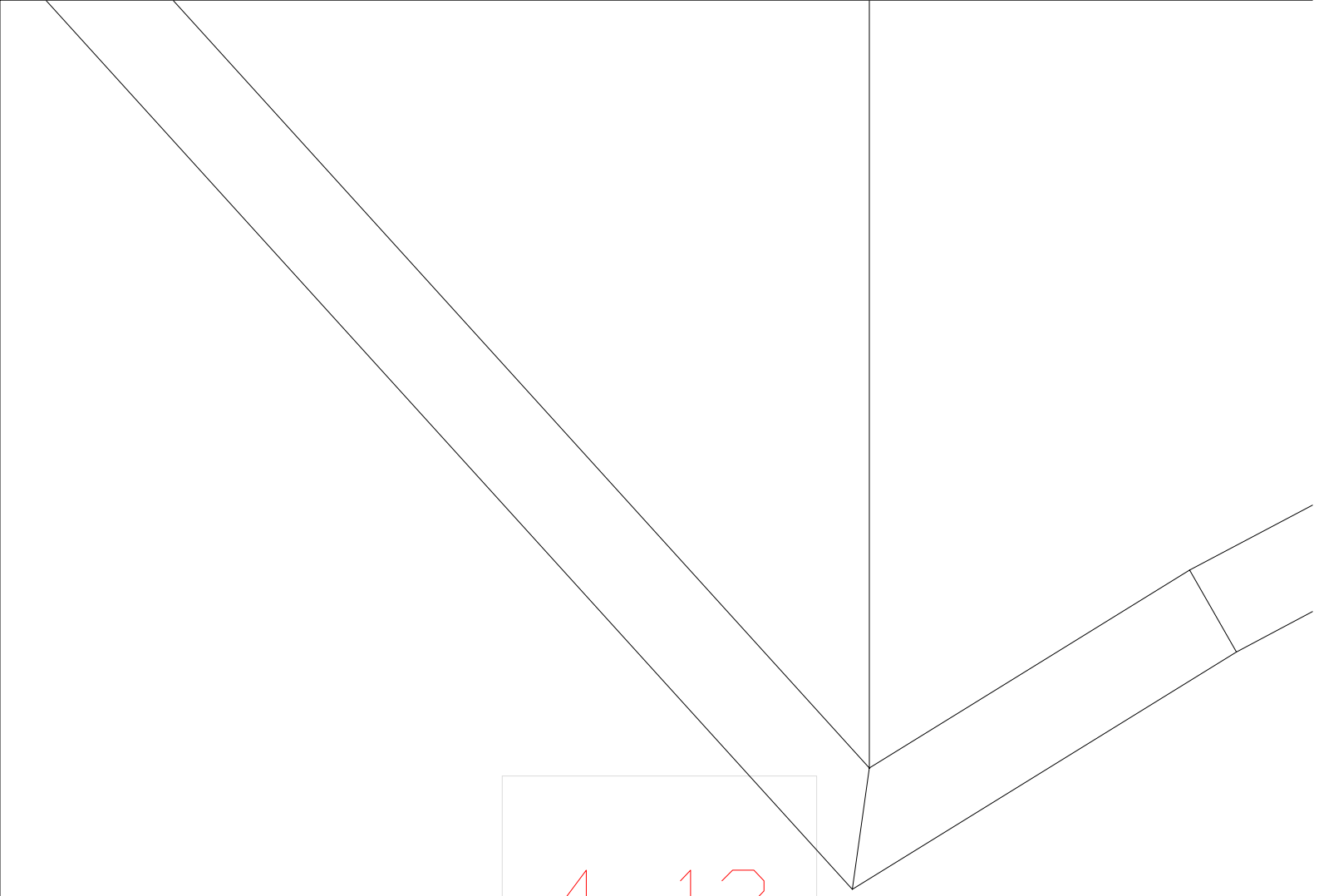

4-12

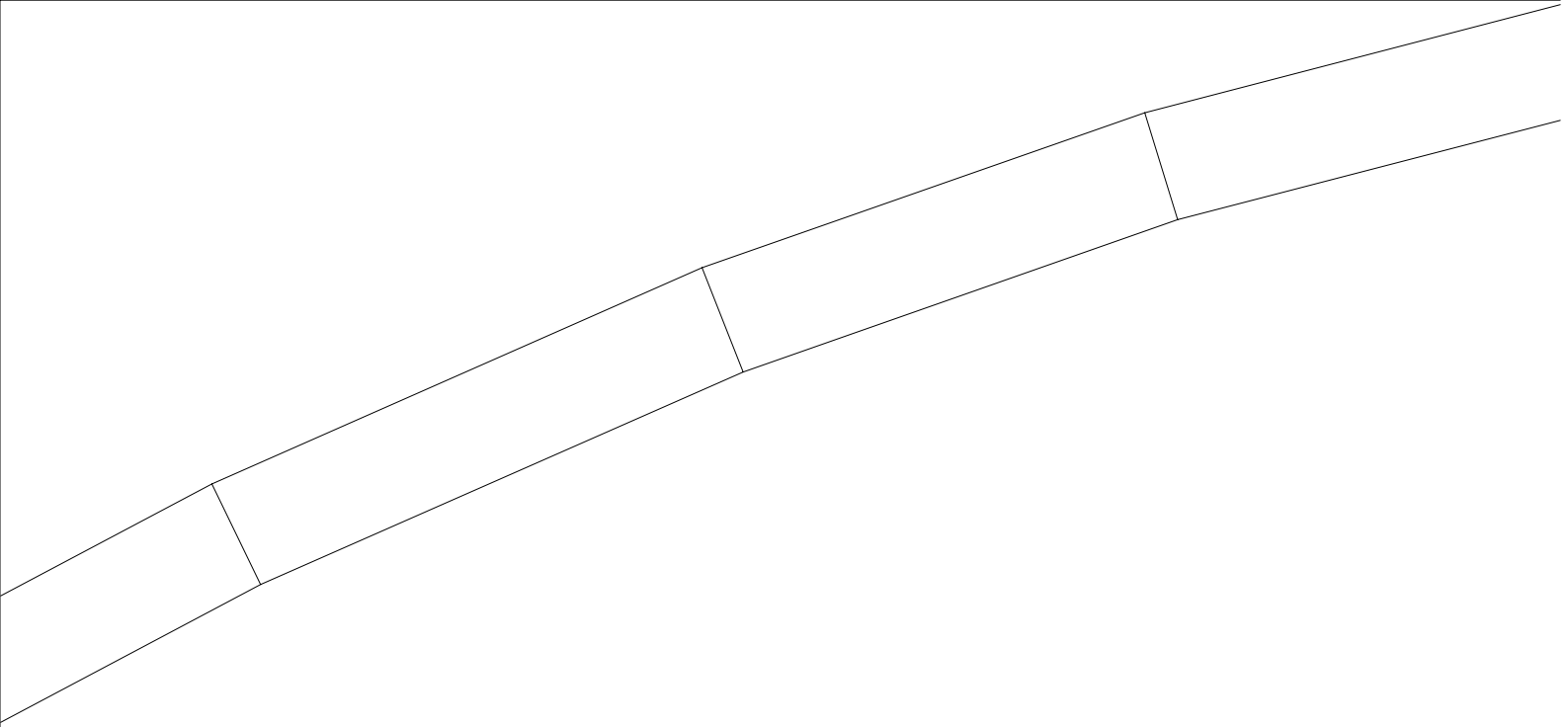

4-13

4-14

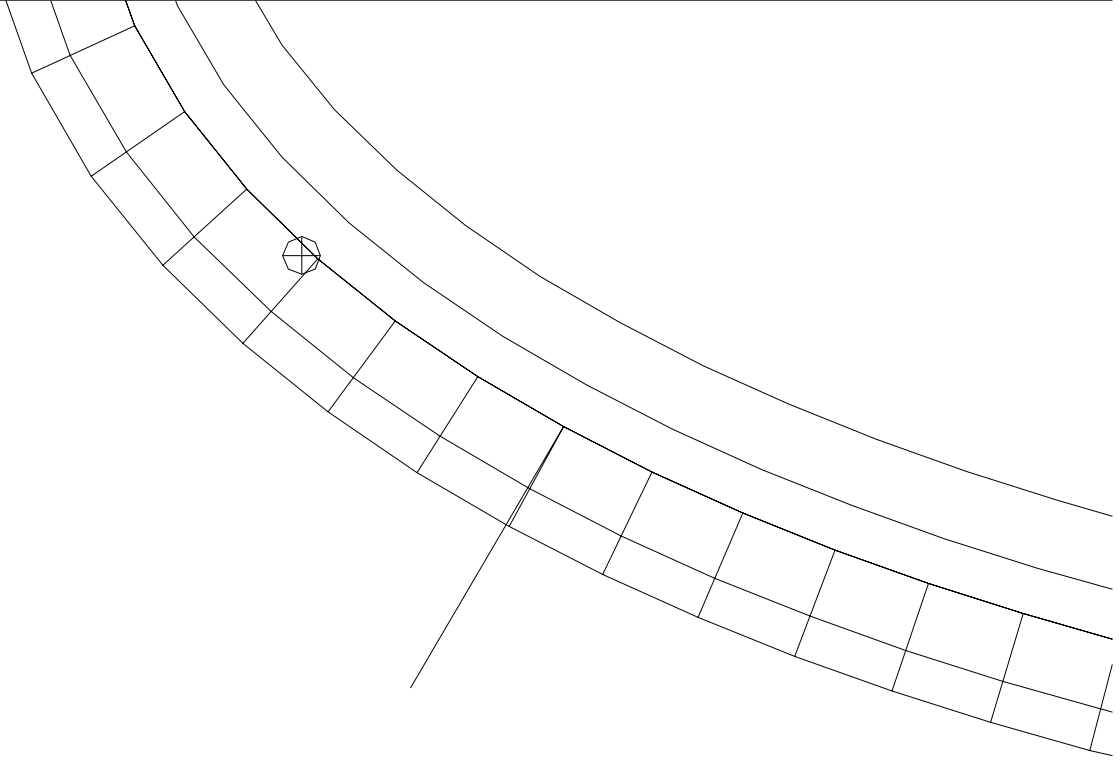

$$4 - 1$$

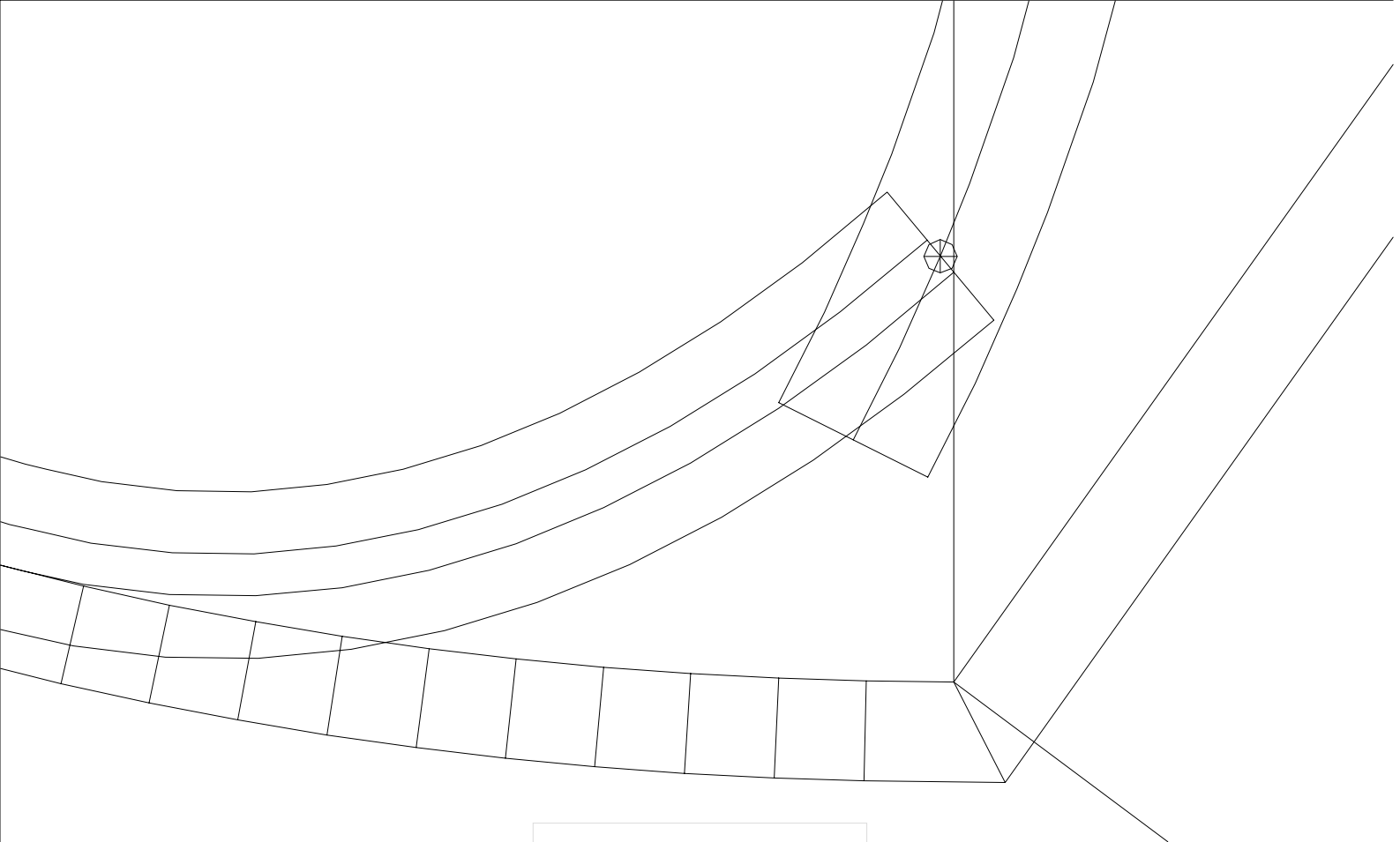

4-2

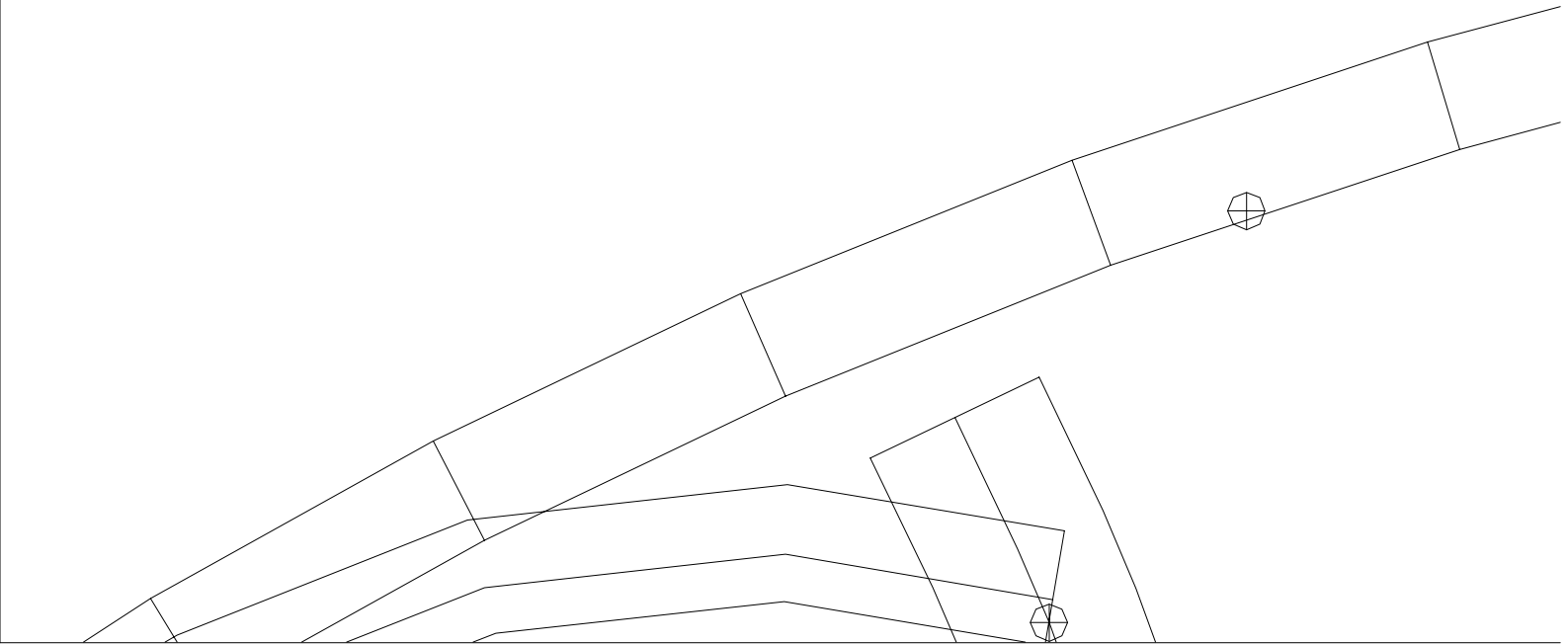

4-3

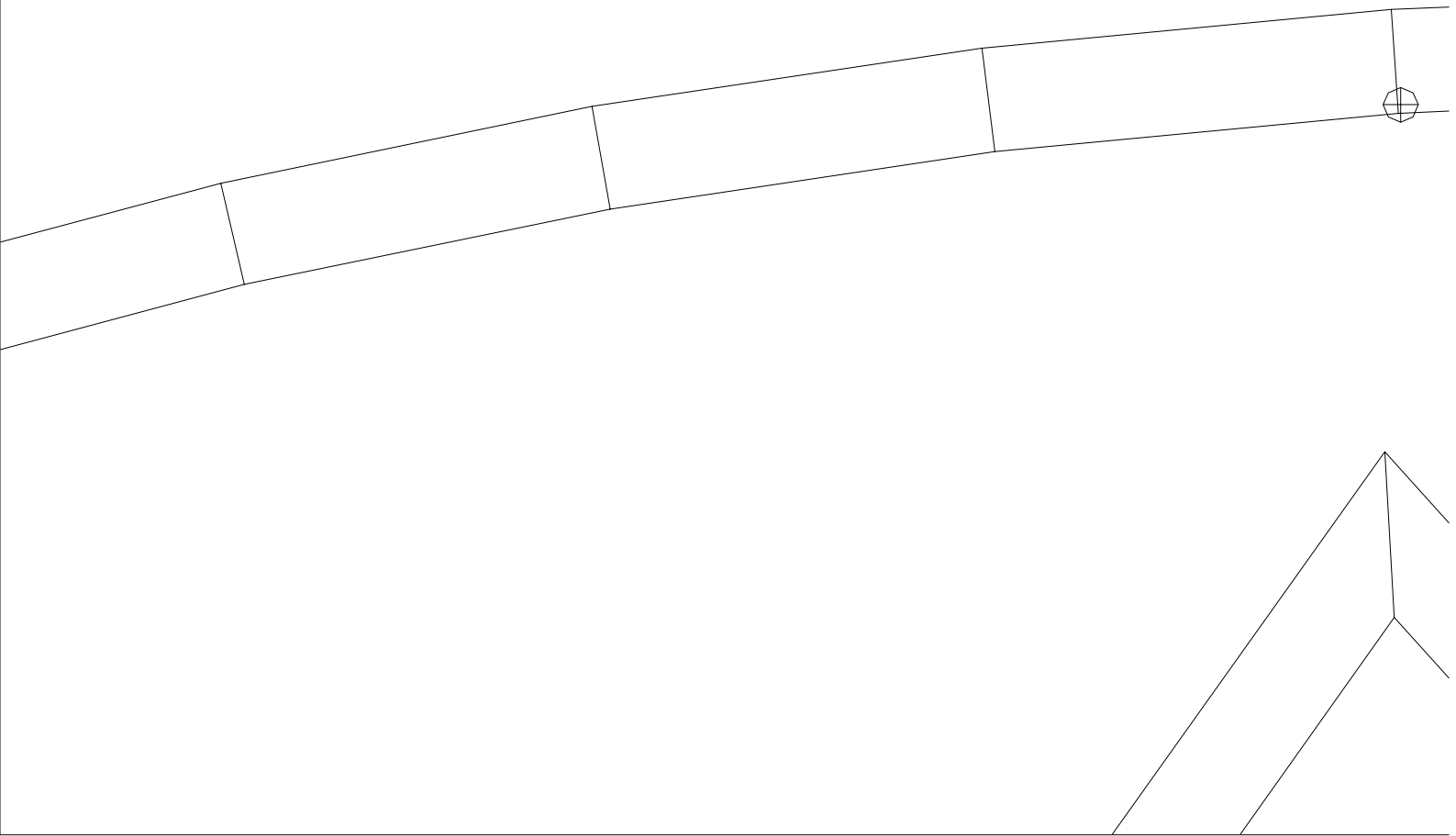

$$4 - 4$$

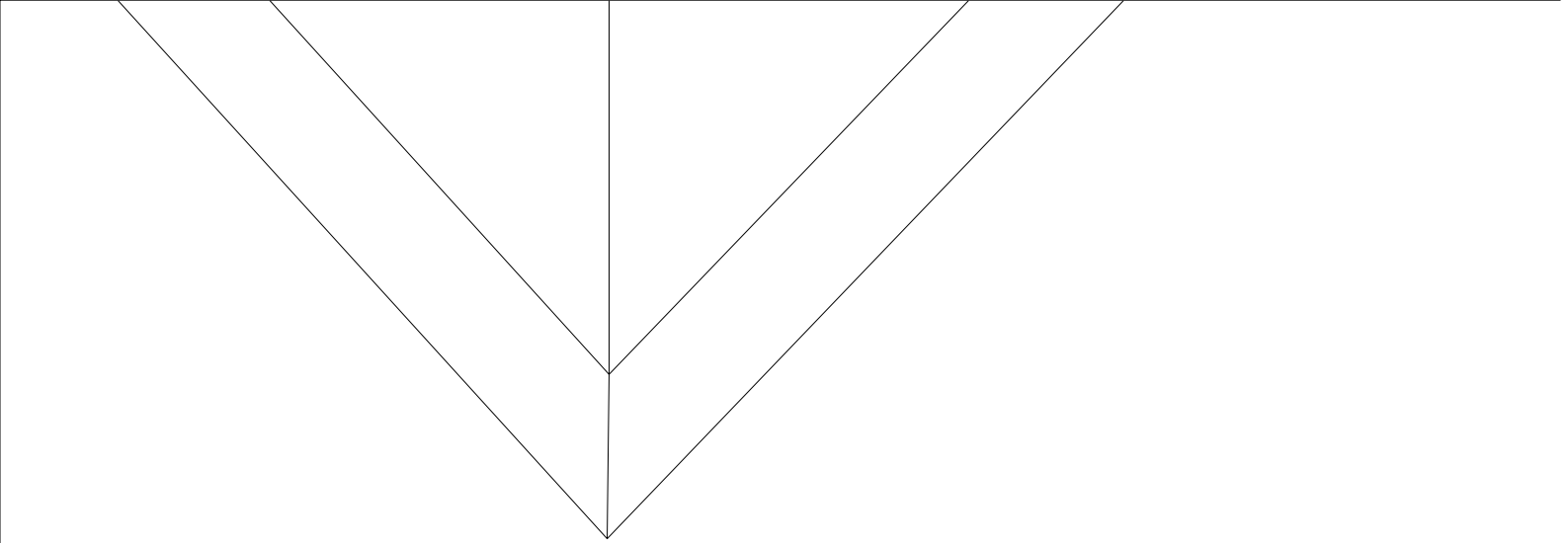

4-5

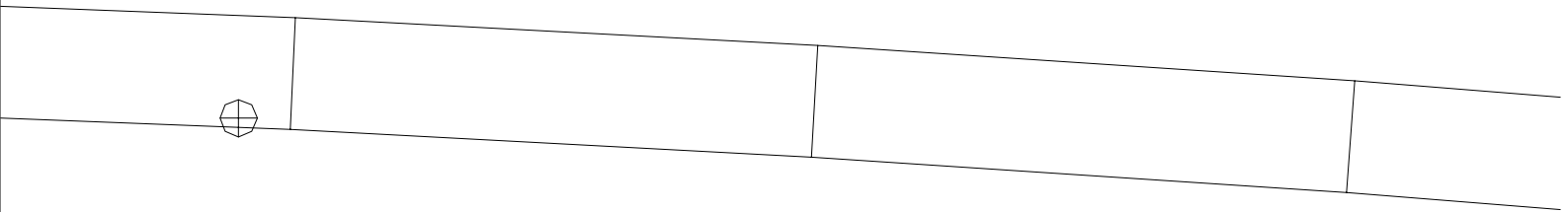

4-6

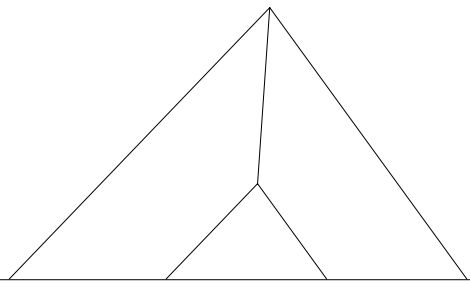

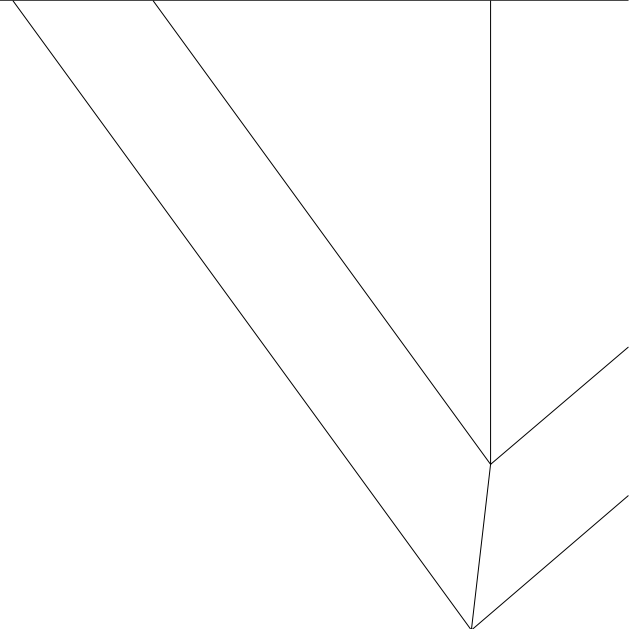

4-7

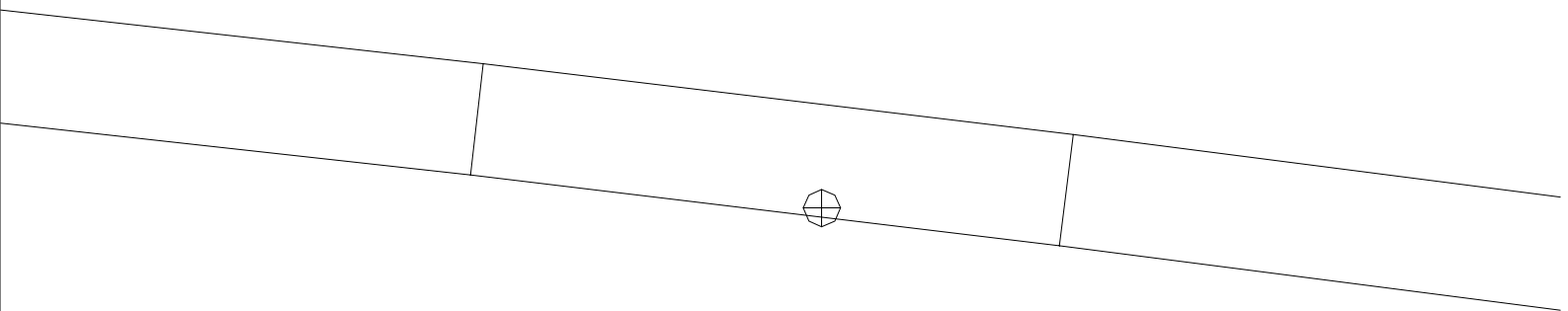

4-8



4-9

5-10

The image shows a technical drawing of a rectangular object, possibly a component or a part of a machine. The object is shown in a perspective view, with the top surface and two side surfaces visible. The top surface is divided into three sections by two vertical lines. The central section is the largest, and the two side sections are smaller. The object is positioned on a flat surface, and the drawing is rendered in black lines on a white background. A central label '5-10' is placed on the top surface of the object.

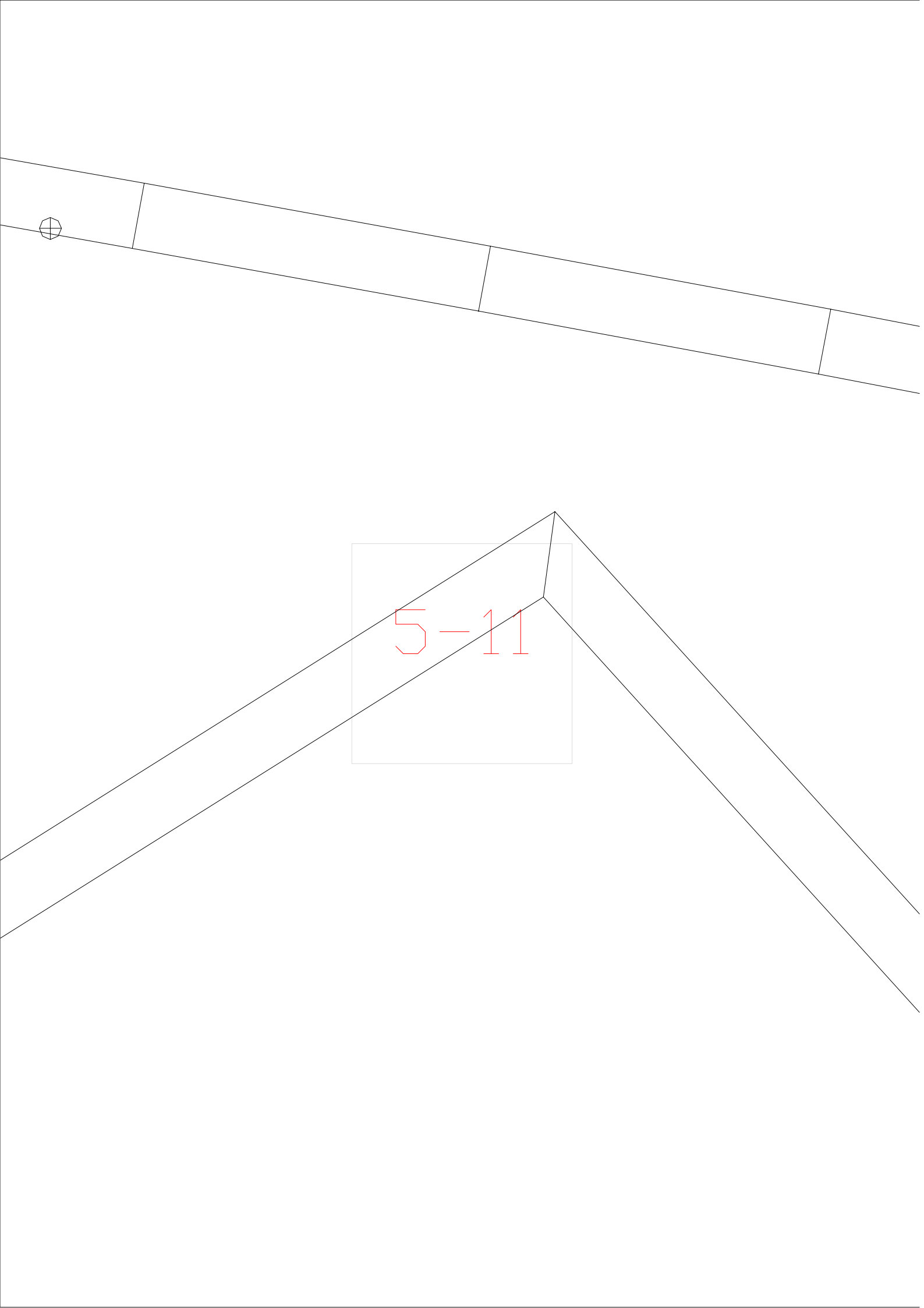

5-11

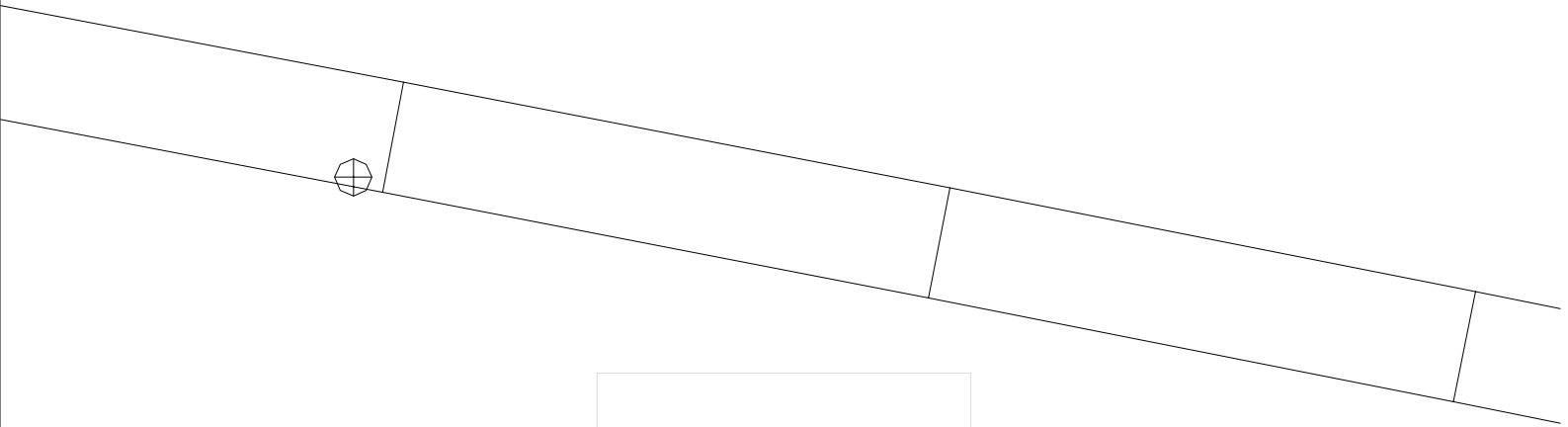

5-12

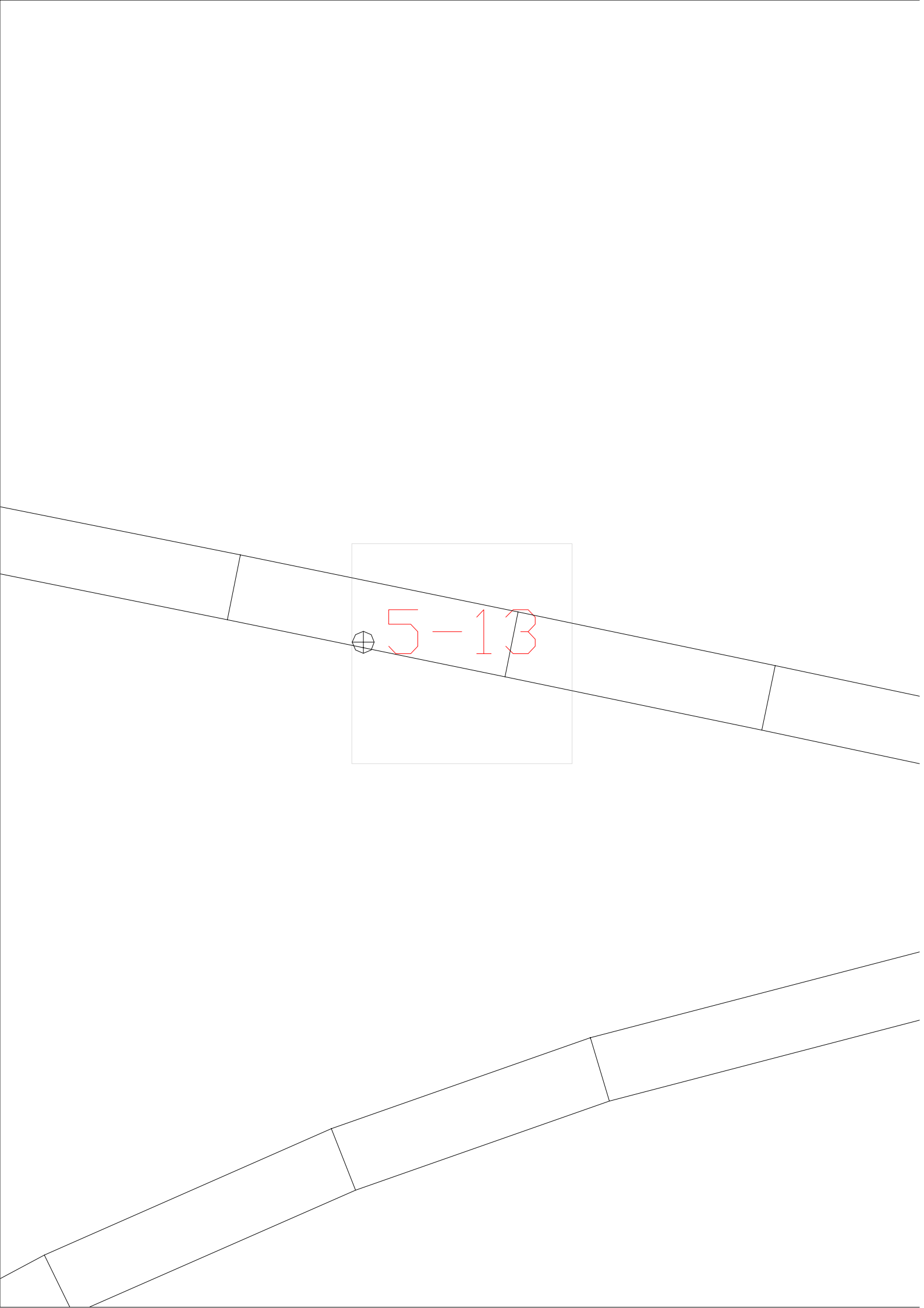

5-13

5-14

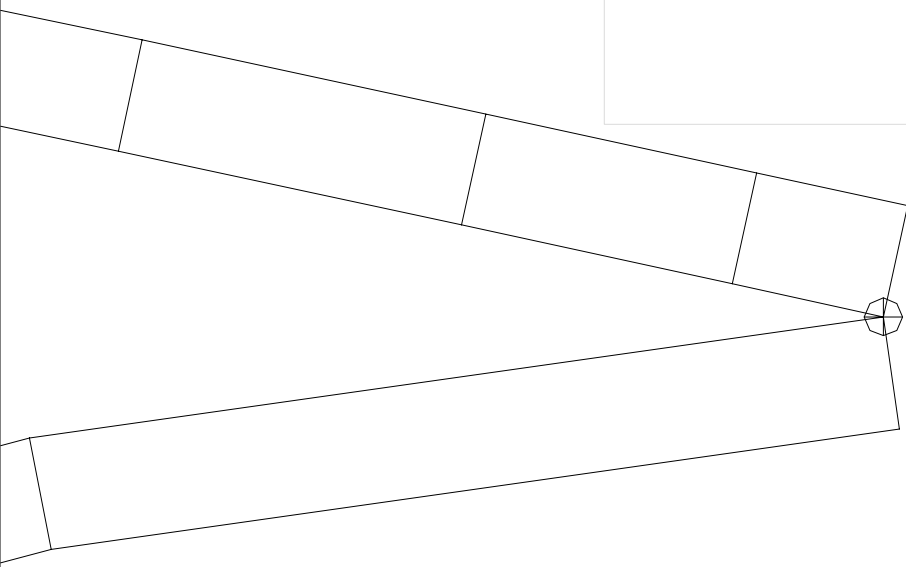

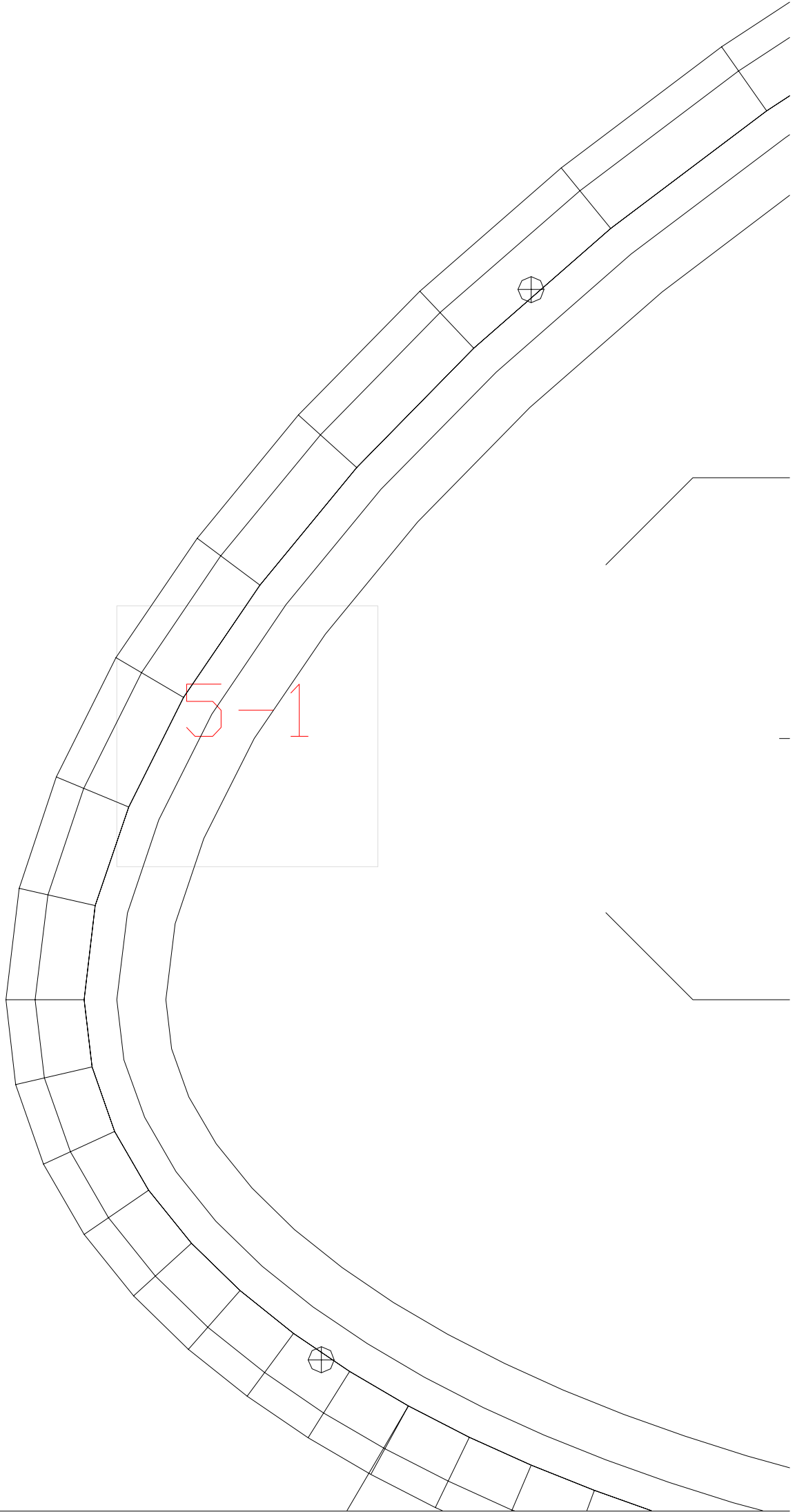

5-1



5-2

The image shows a technical drawing of a mechanical part, possibly a valve or a similar component. The drawing is composed of several lines representing the geometry of the part. A central rectangular area is highlighted with a light gray border, containing the red text '5-2'. To the left of this central area, there is a vertical section with a series of horizontal lines, suggesting a stepped or flanged structure. The right side of the drawing features a curved profile, likely representing the outer surface of the part. At the bottom right, there is a small circular feature with a cross-hatch pattern, possibly indicating a hole or a specific material property. The overall drawing is a line drawing with no shading or color, typical of a technical drawing.



5-3



5-4

5-5



5-6

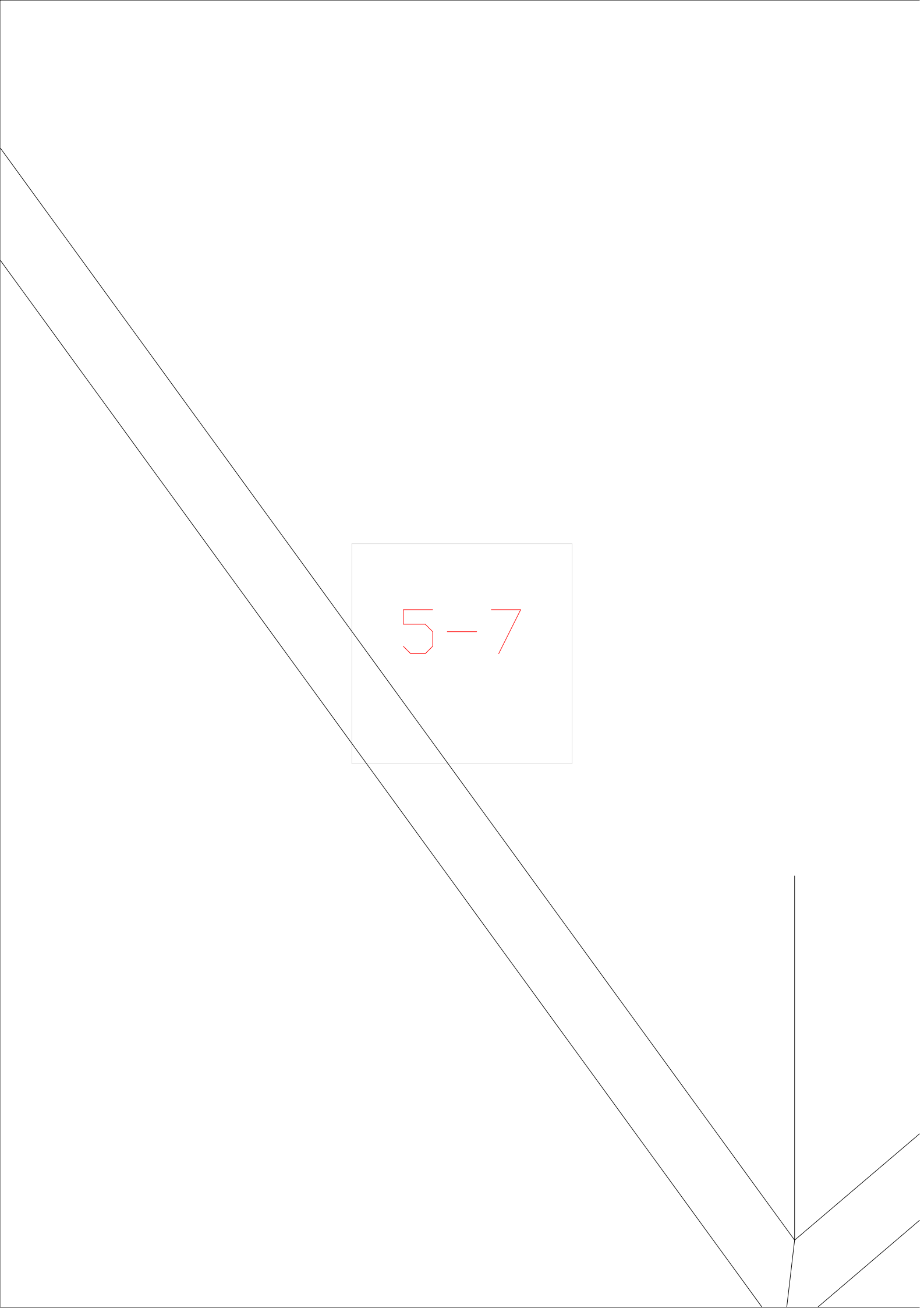

5-7

5-8

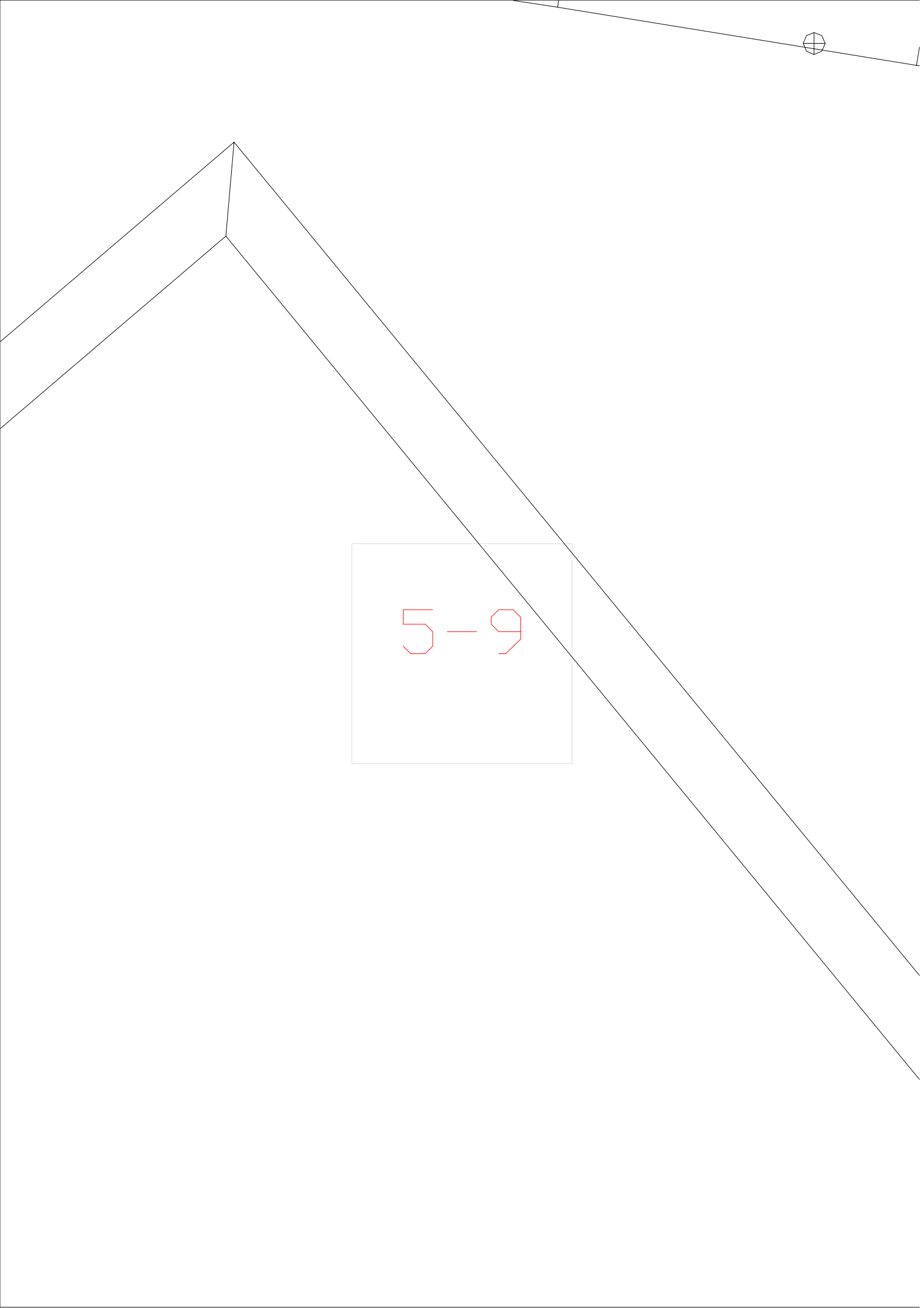

5-9

6-10



6-11

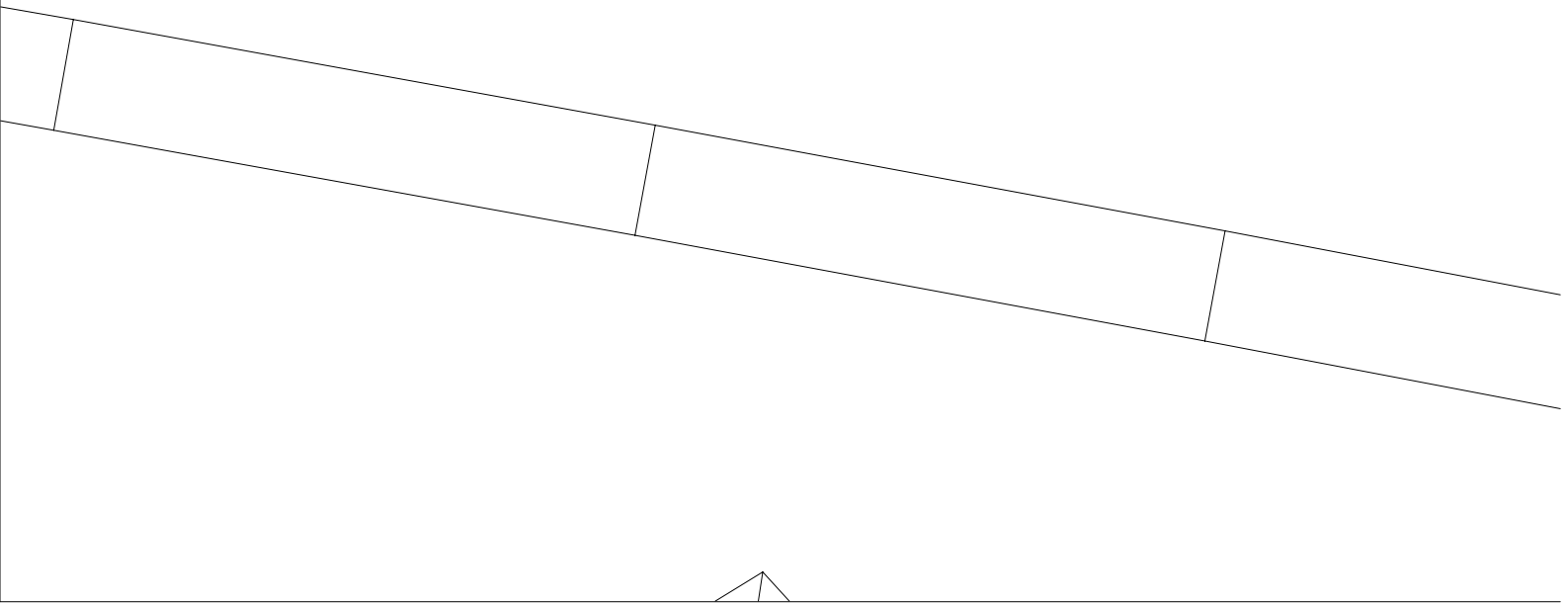

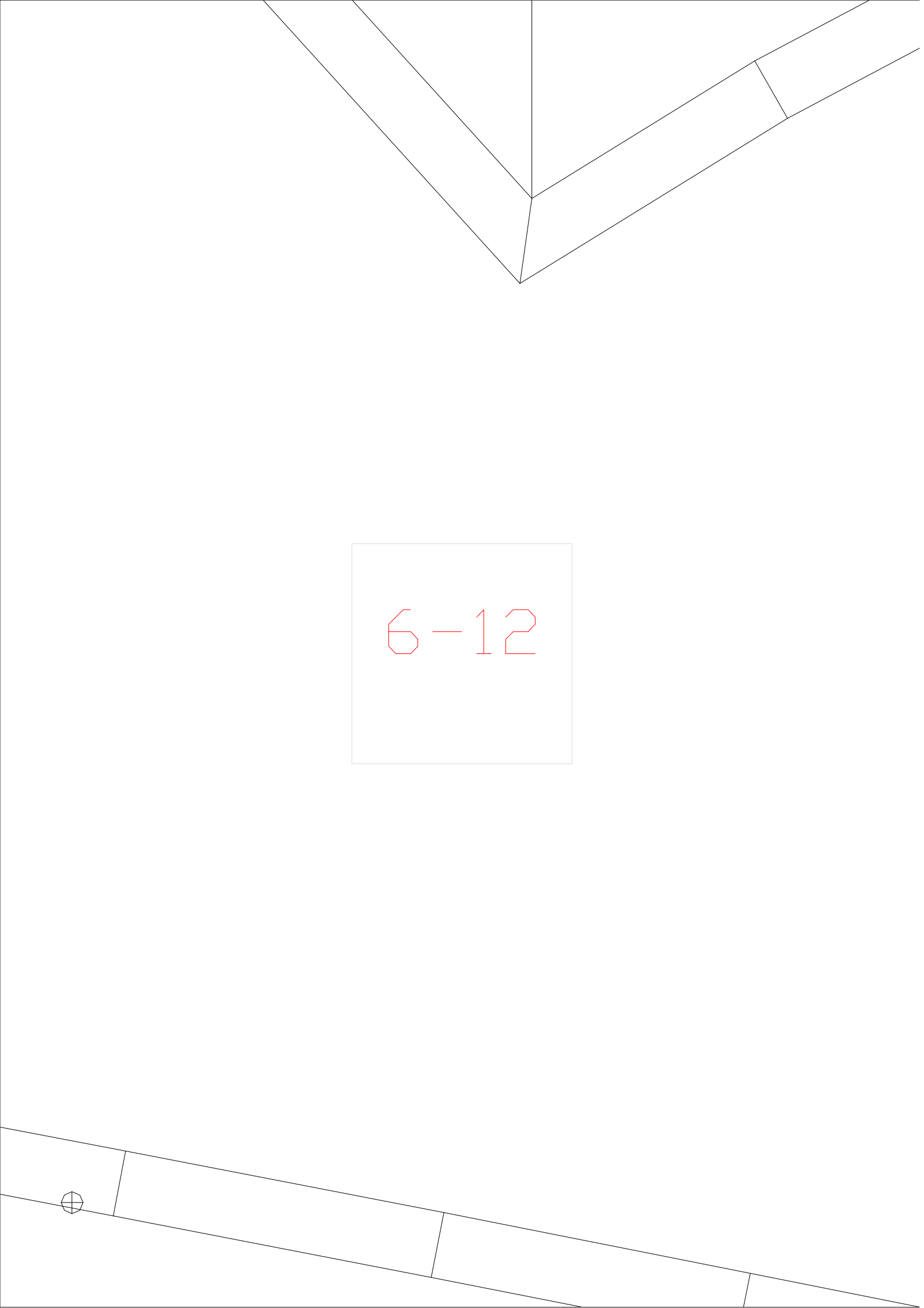

6-12

The image shows a technical drawing of a V-shaped groove. The groove is defined by two lines meeting at a point at the top. A vertical line bisects the groove. A horizontal line is drawn across the groove, and a small vertical line segment is drawn from the right side of the groove to this horizontal line. In the center of the drawing, there is a rectangular box containing the text '6-12' in red. At the bottom of the drawing, there are several lines forming a base, and a small circle with a cross inside is located on the left side of the base.

6-13

6-14

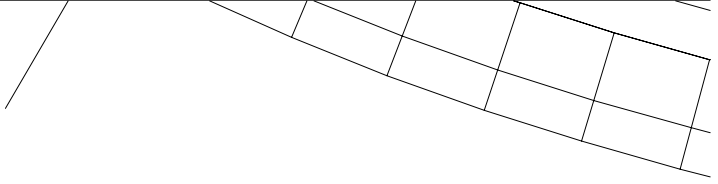

6-1

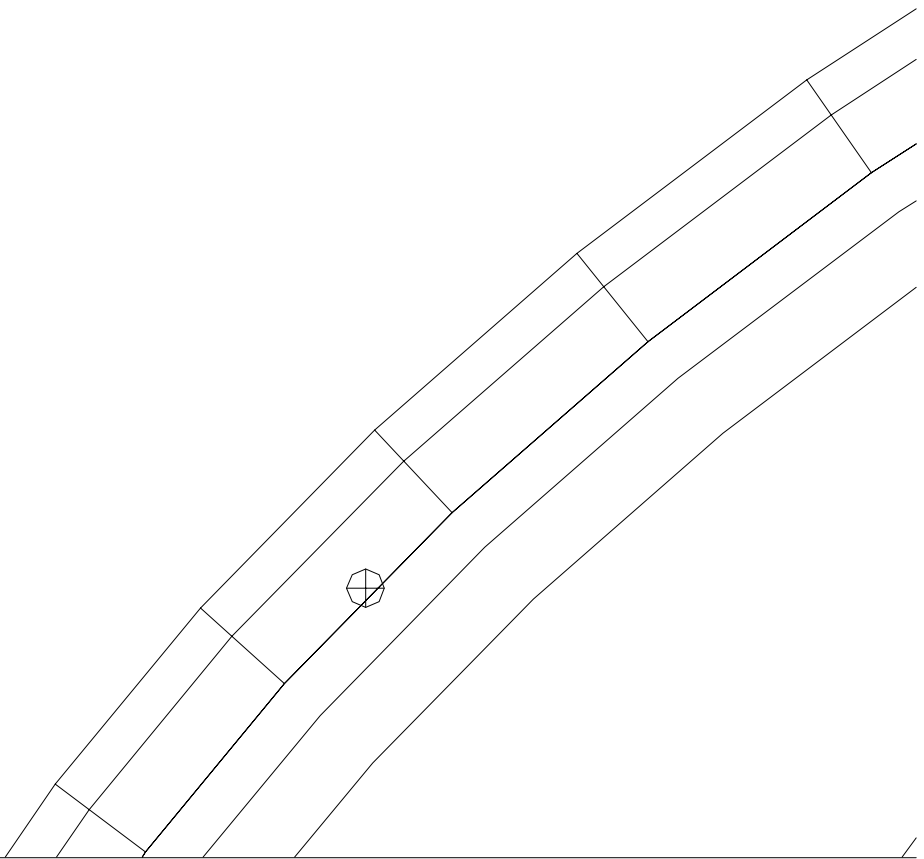

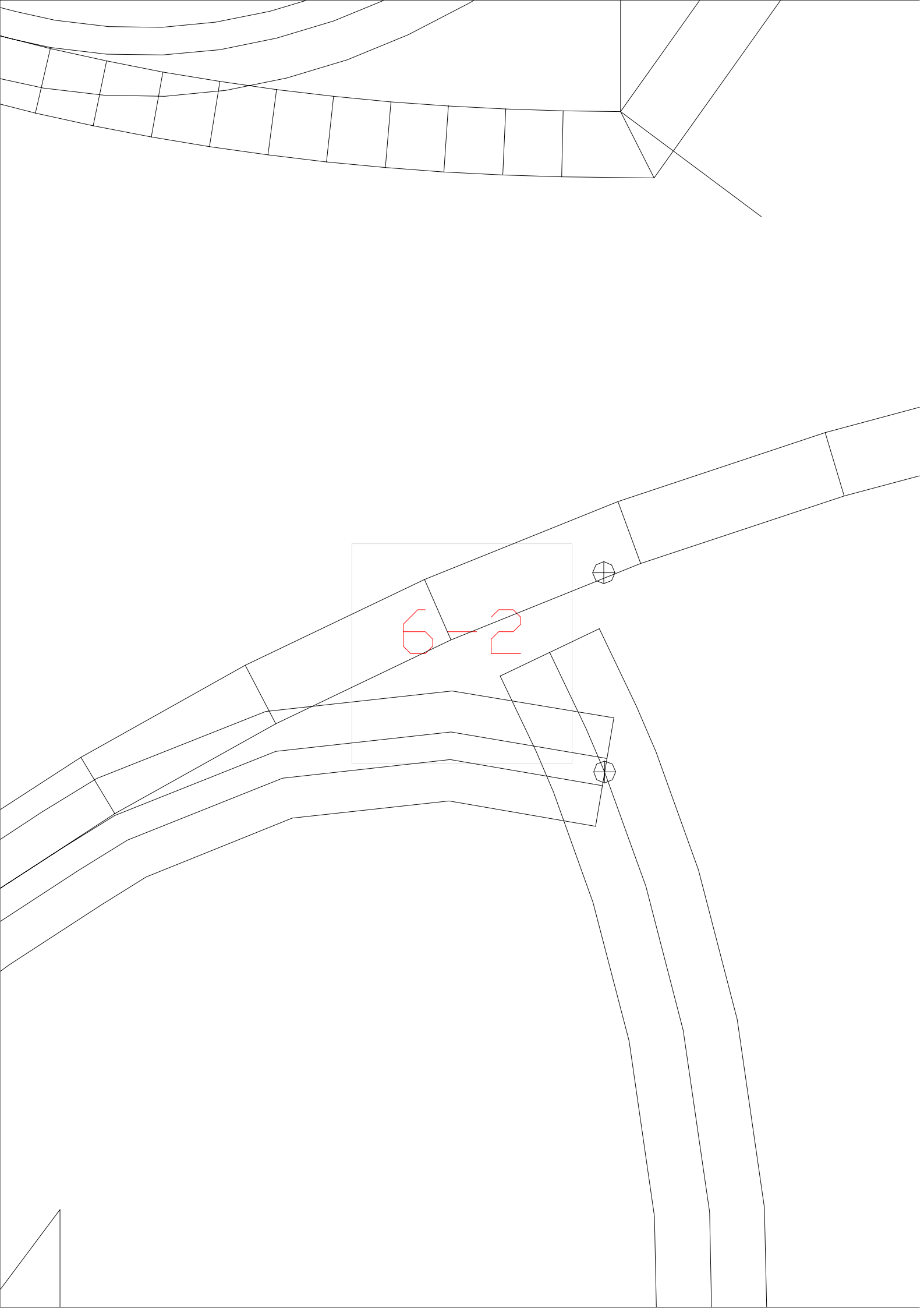

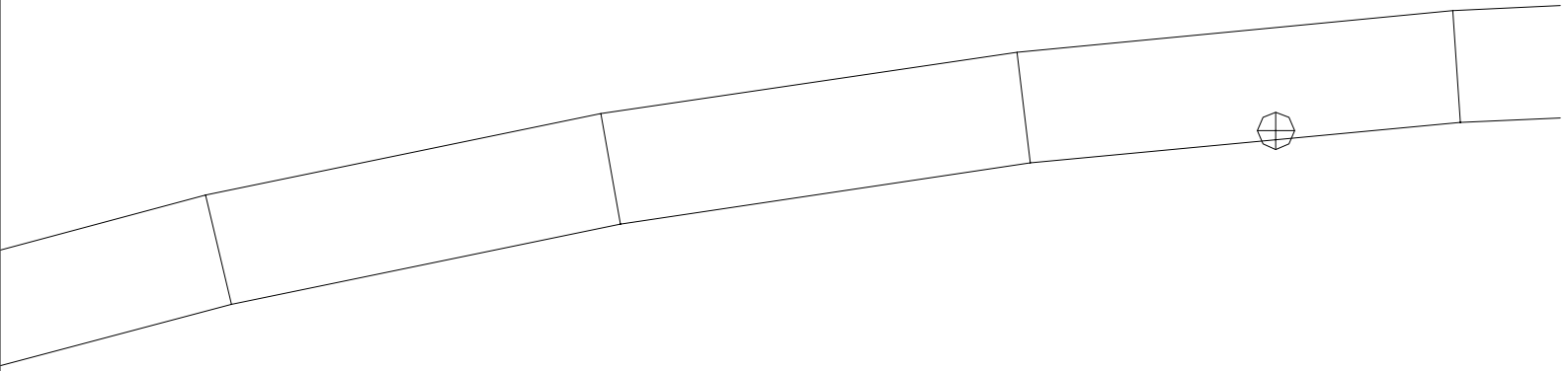

6-3

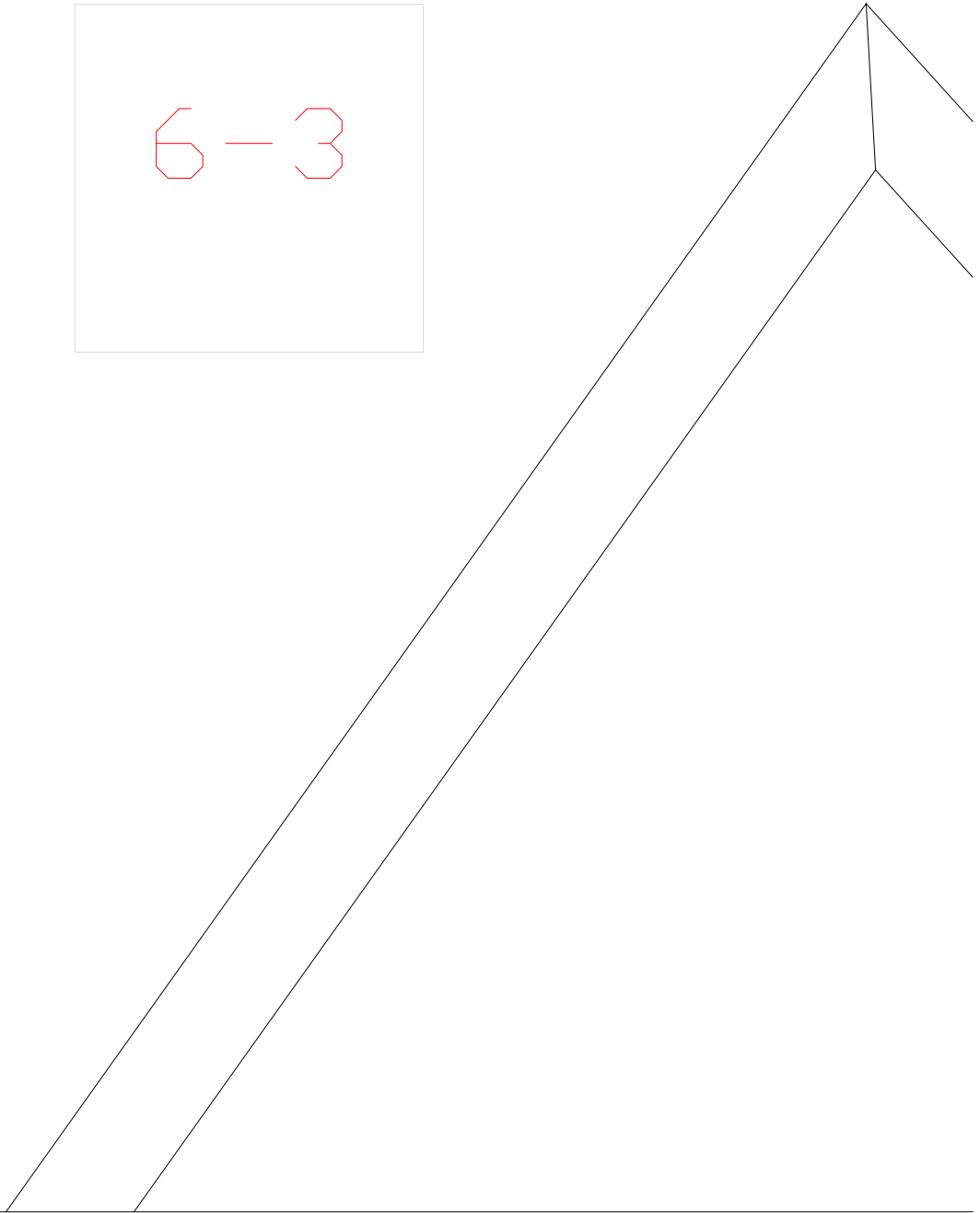

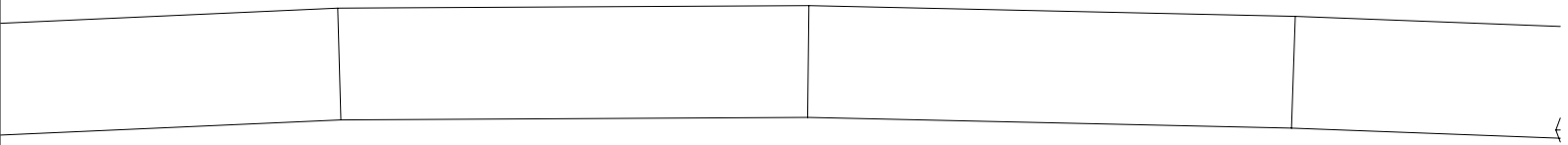

$$6 - 4$$

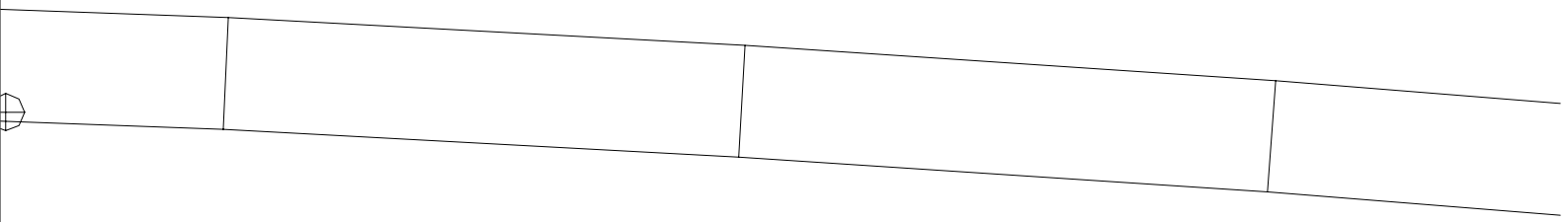

6-5

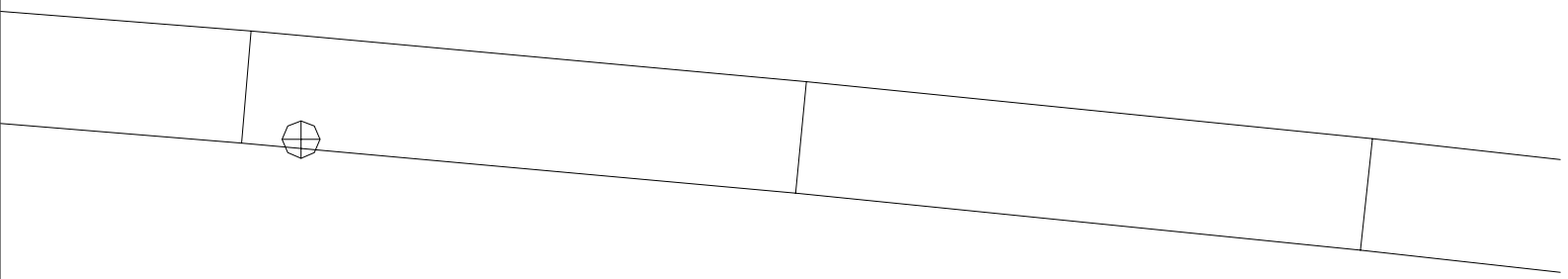

6-6

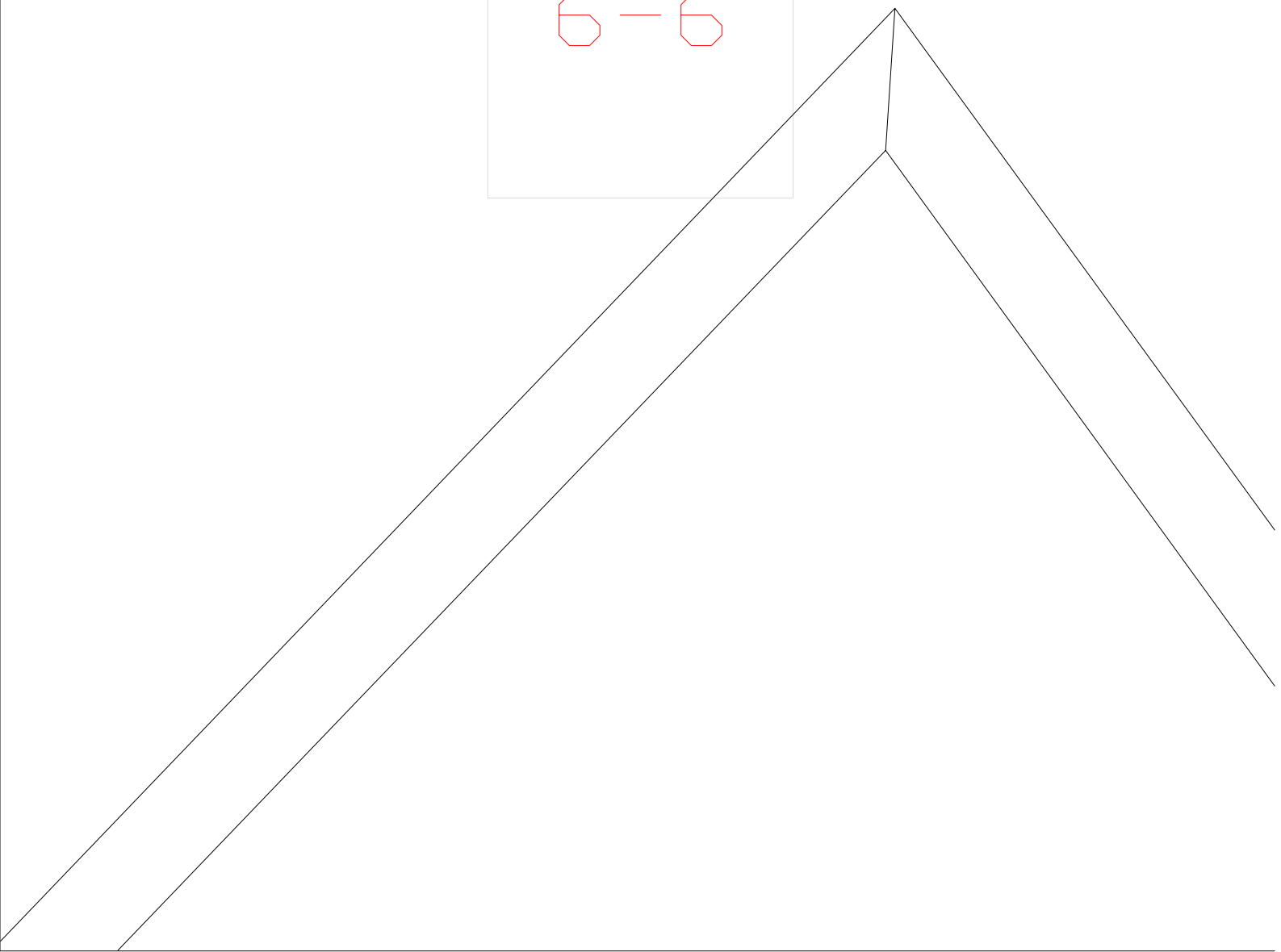

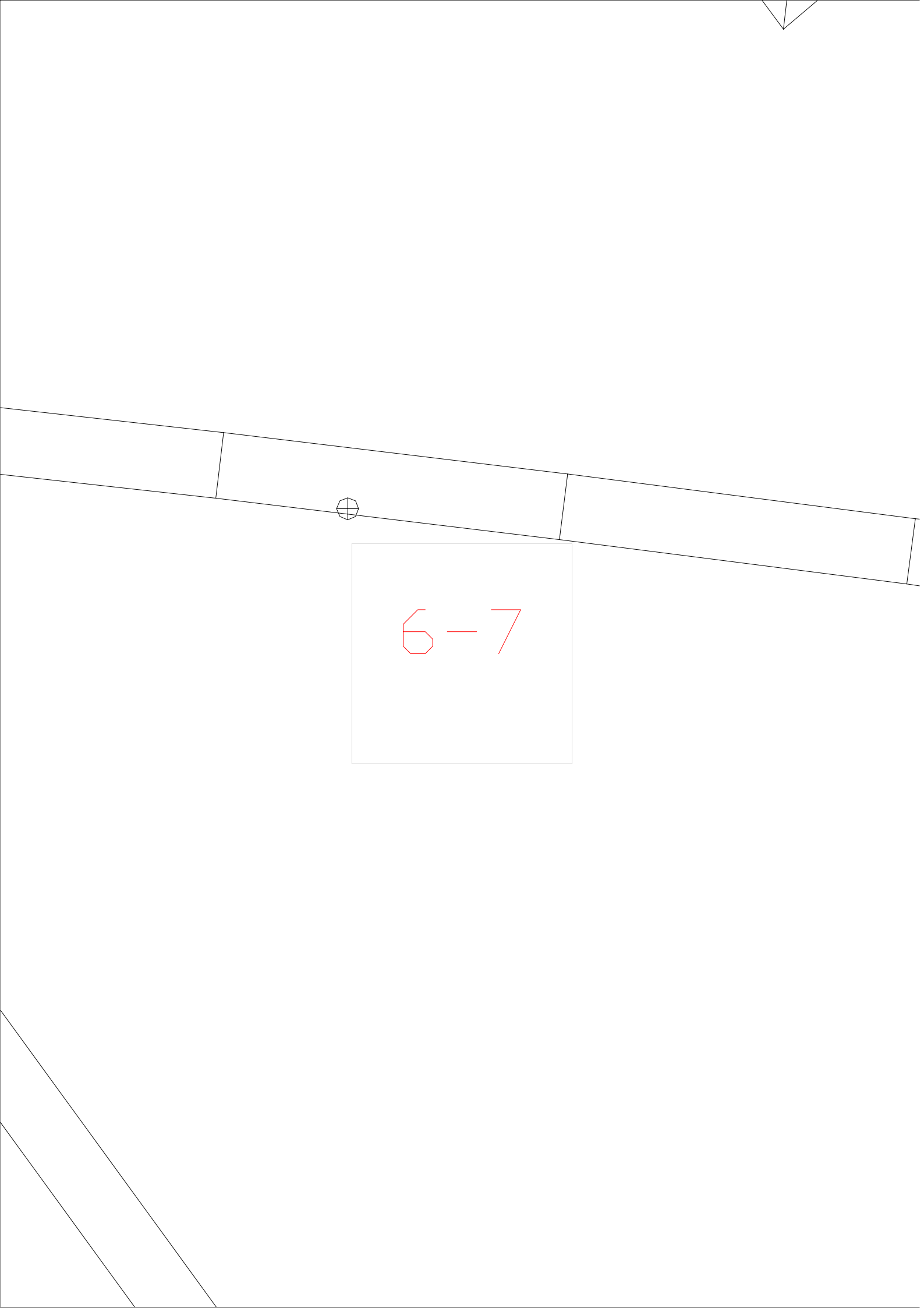

6-7

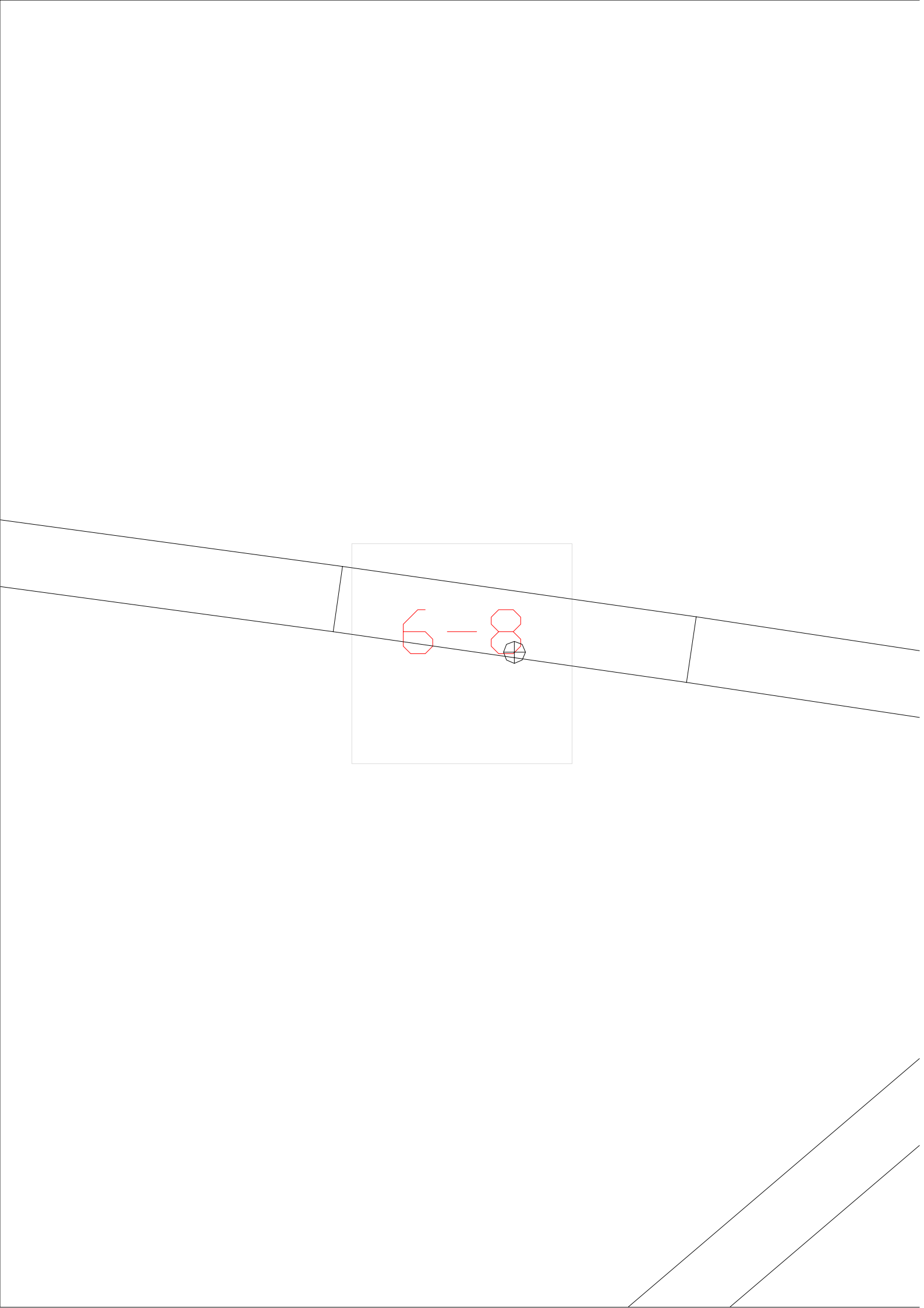

6-9



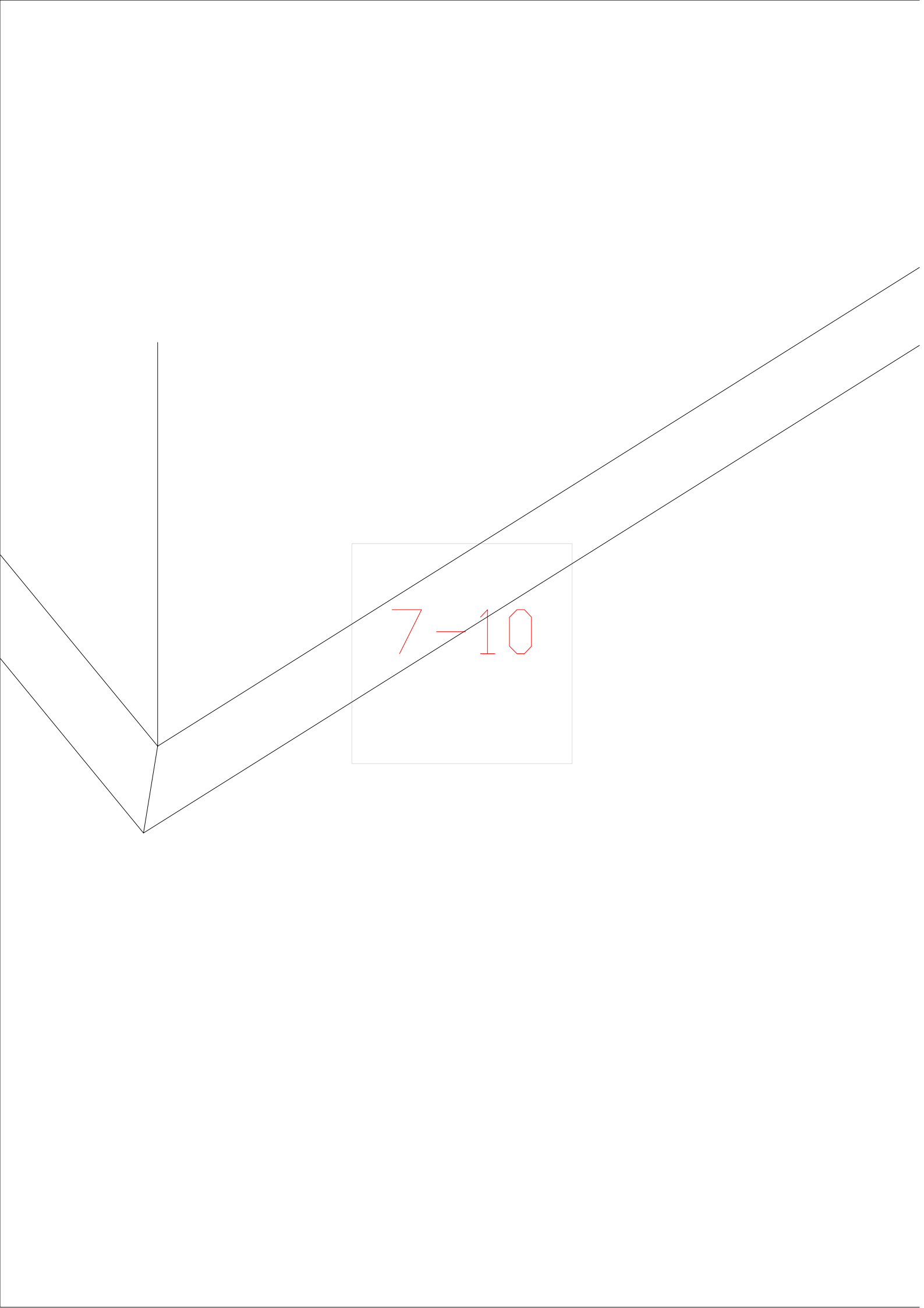

7-10

A diagram of a roof structure is shown at the top of the page. It consists of several lines forming a gabled shape. A central square is drawn in the middle of the page, containing the text "7-11" in red. The text is centered within the square and consists of the number "7", a hyphen "-", and the number "11".

7-11

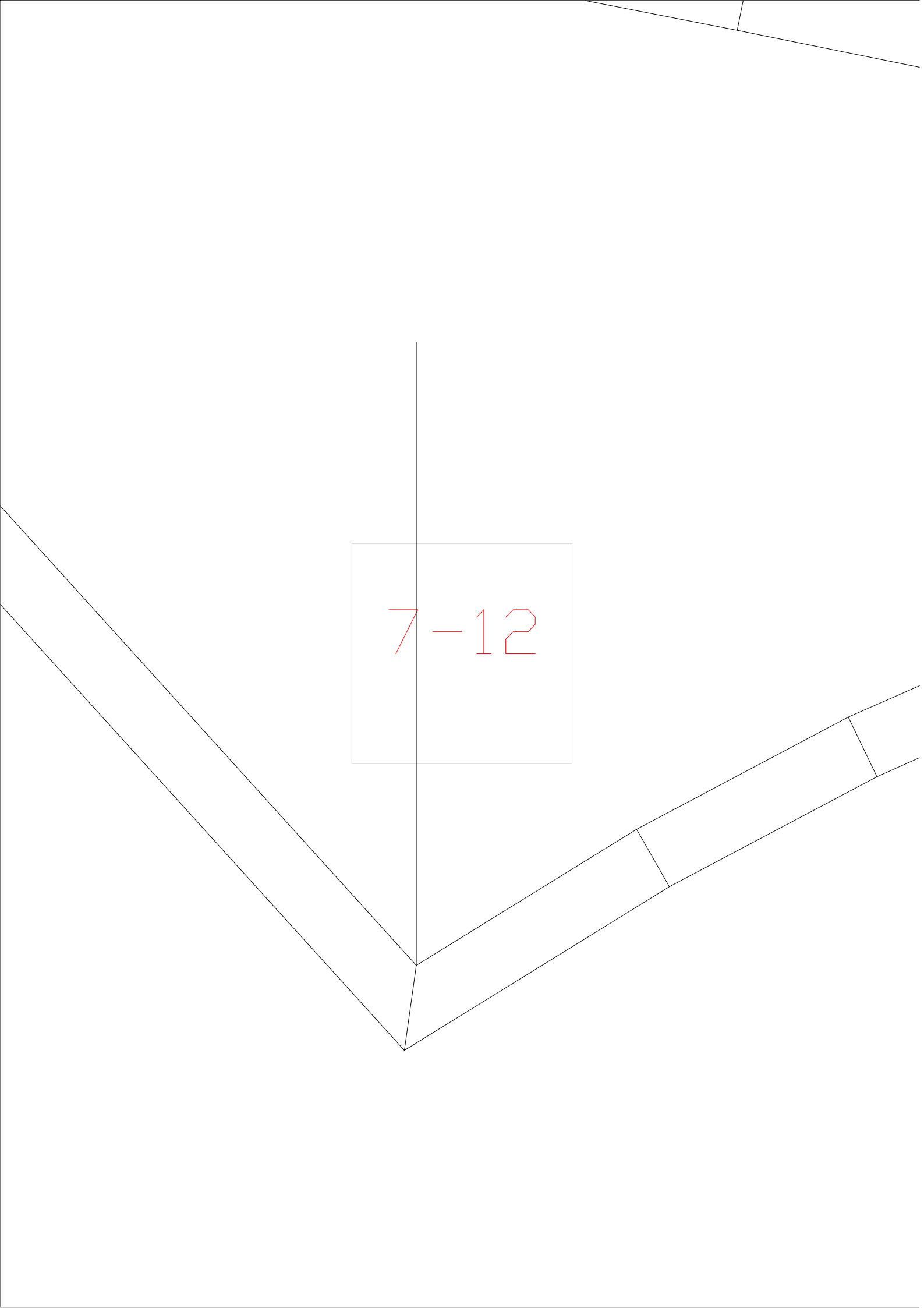

7-12

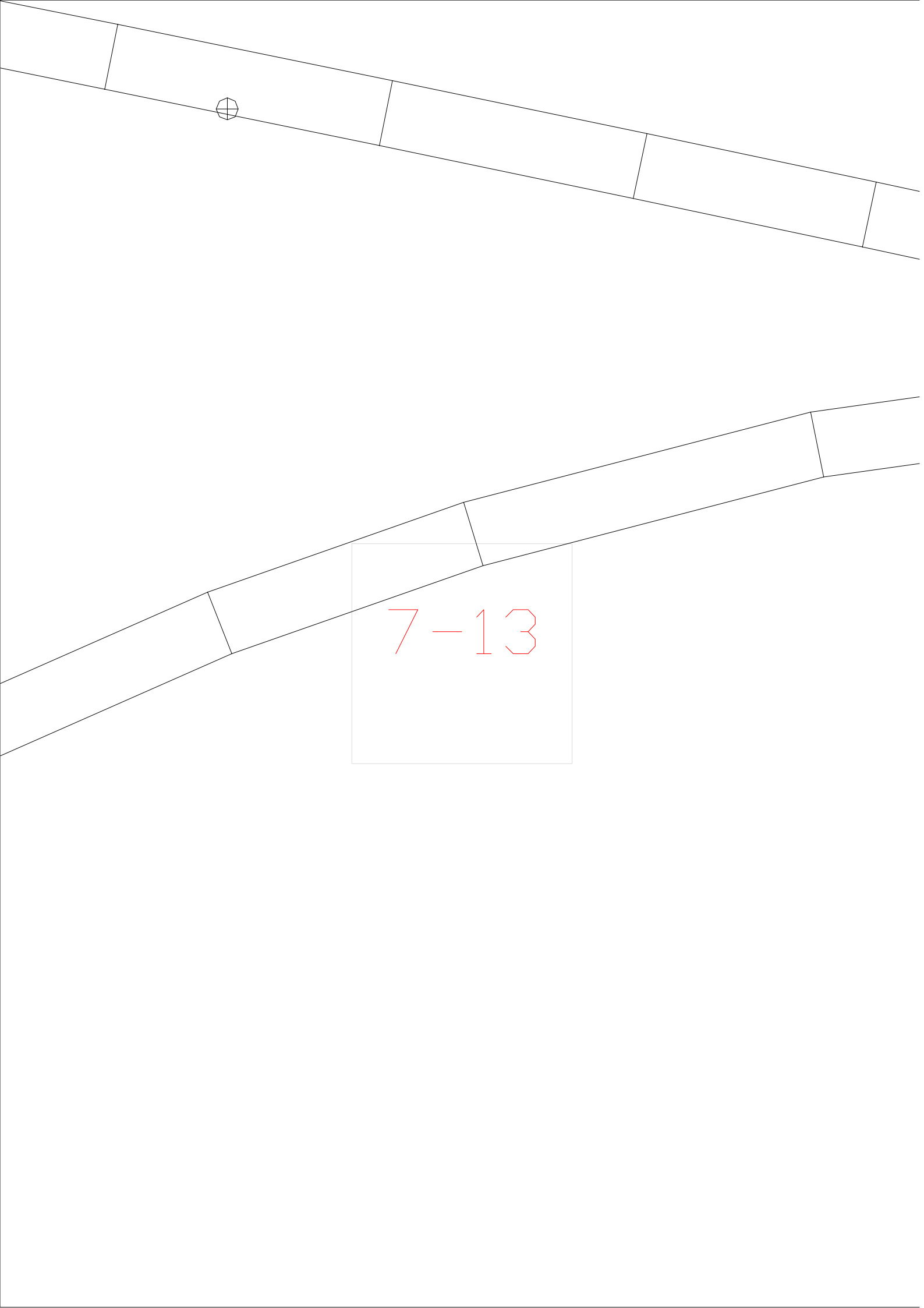

7-13

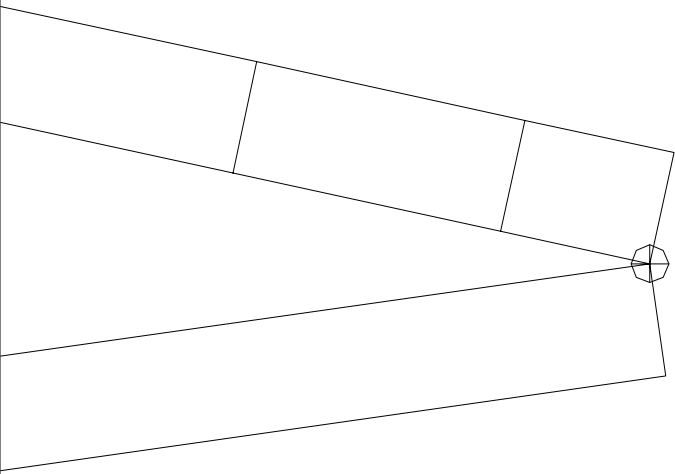

7-14

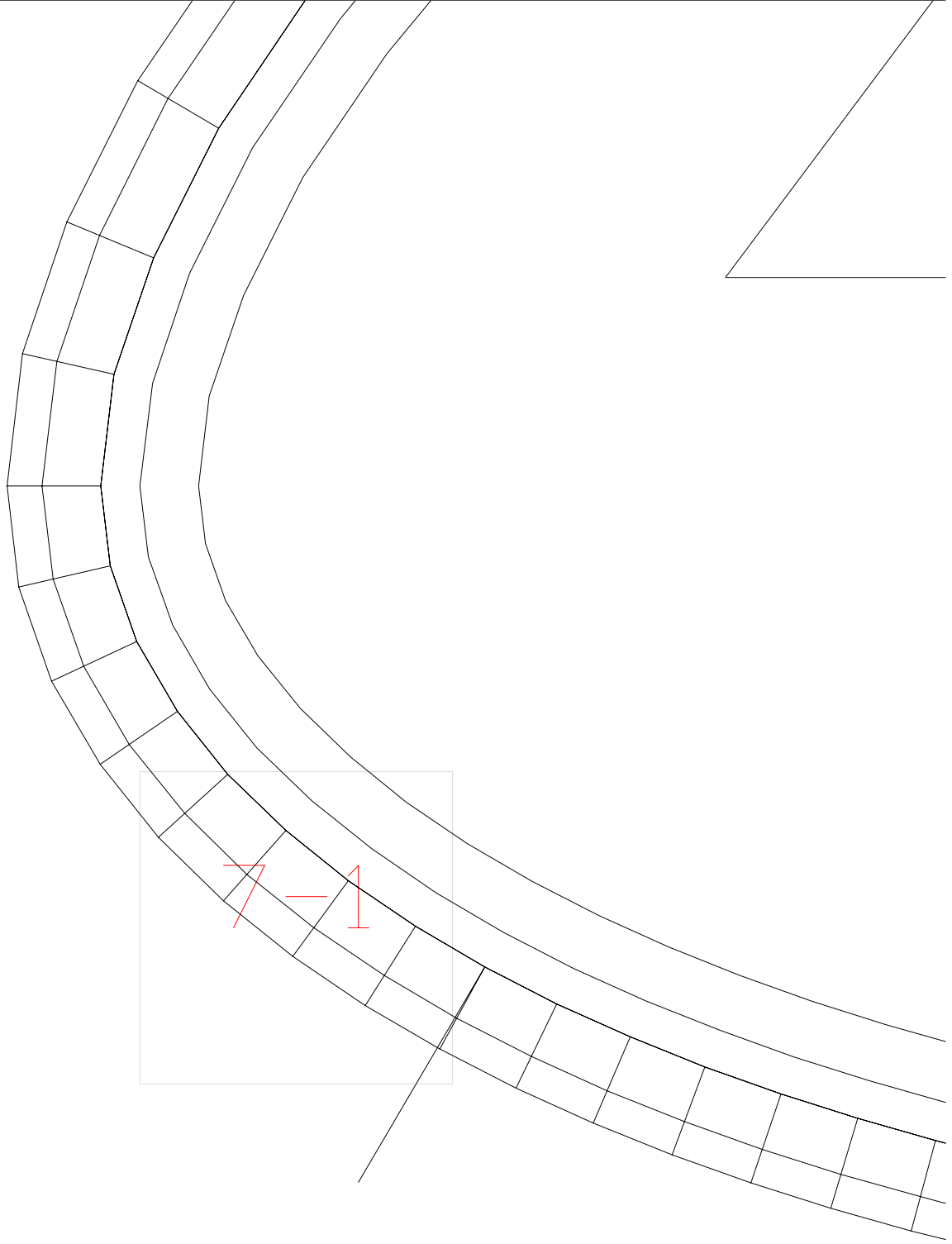

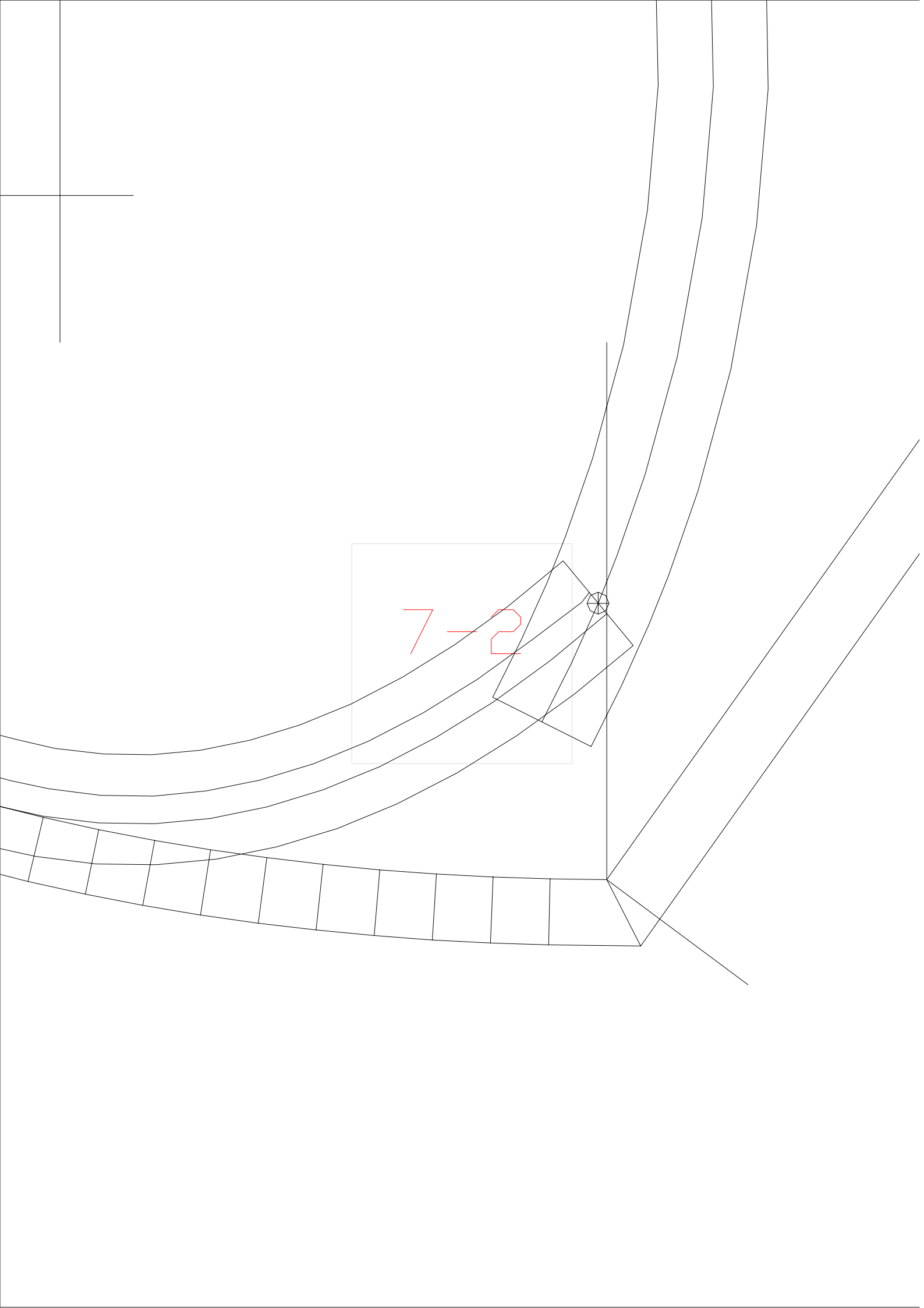



7-3



$$7 - 4$$

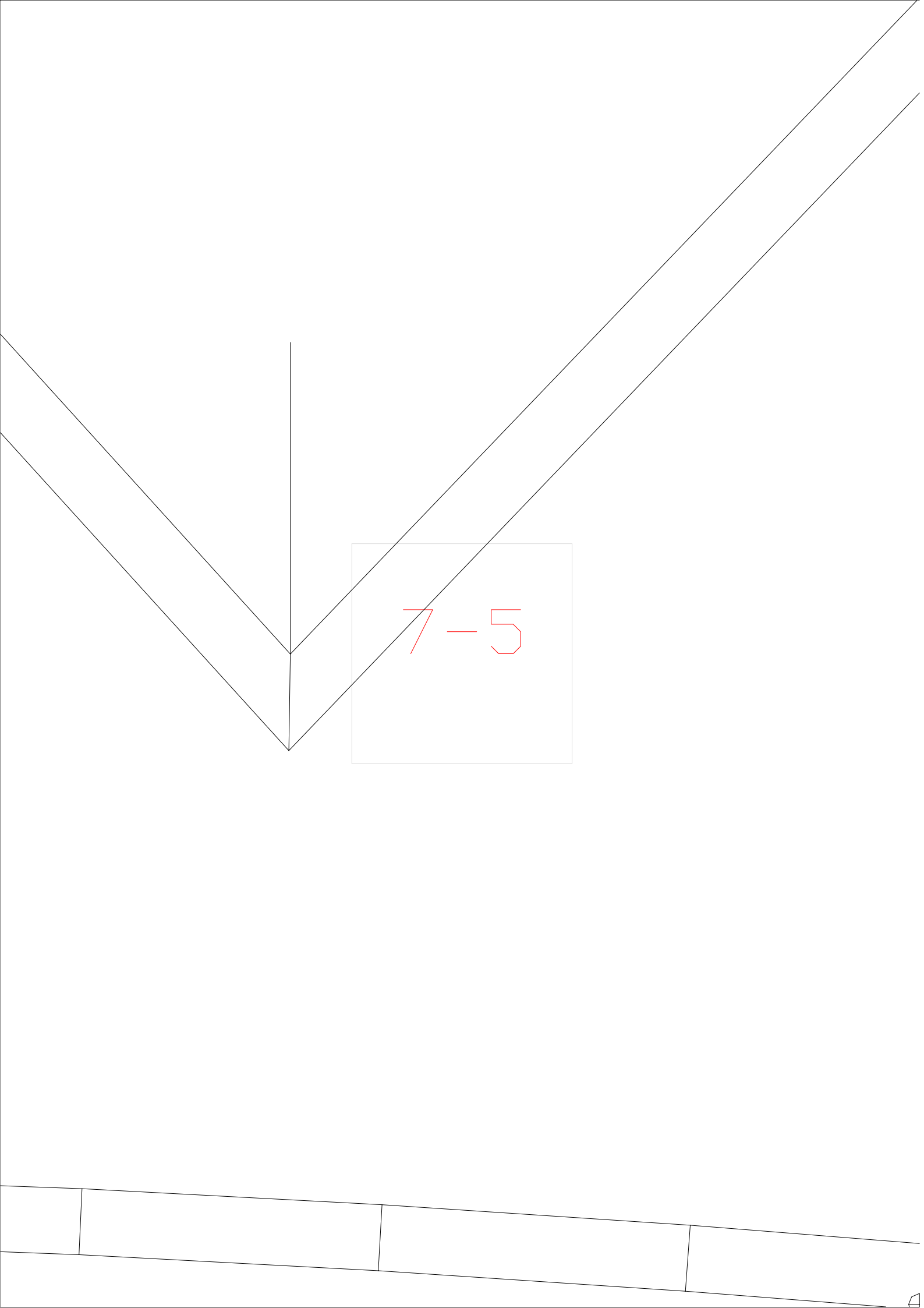

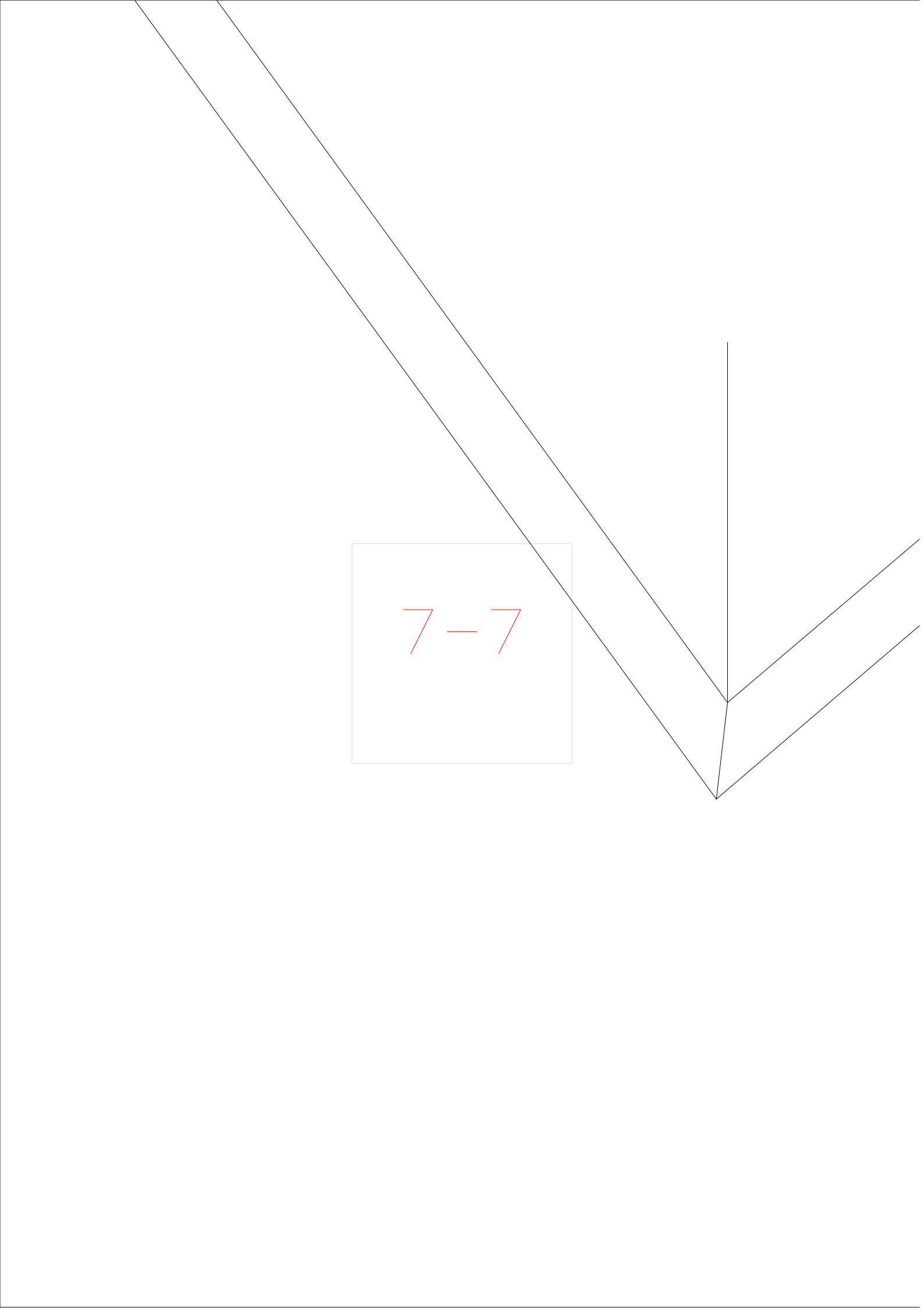

7-5

7-6



The diagram features a large, hollow arrow pointing downwards, centered on the page. Inside the arrow, there is a rectangular box with a thin border. Inside this box, the equation $7-7$ is written in red. The arrow's shaft is formed by two parallel lines that converge towards a point at the bottom. From this point, a vertical line extends upwards, and two diagonal lines extend outwards to the right, forming the arrowhead.

$$7-7$$



7-8



7-9

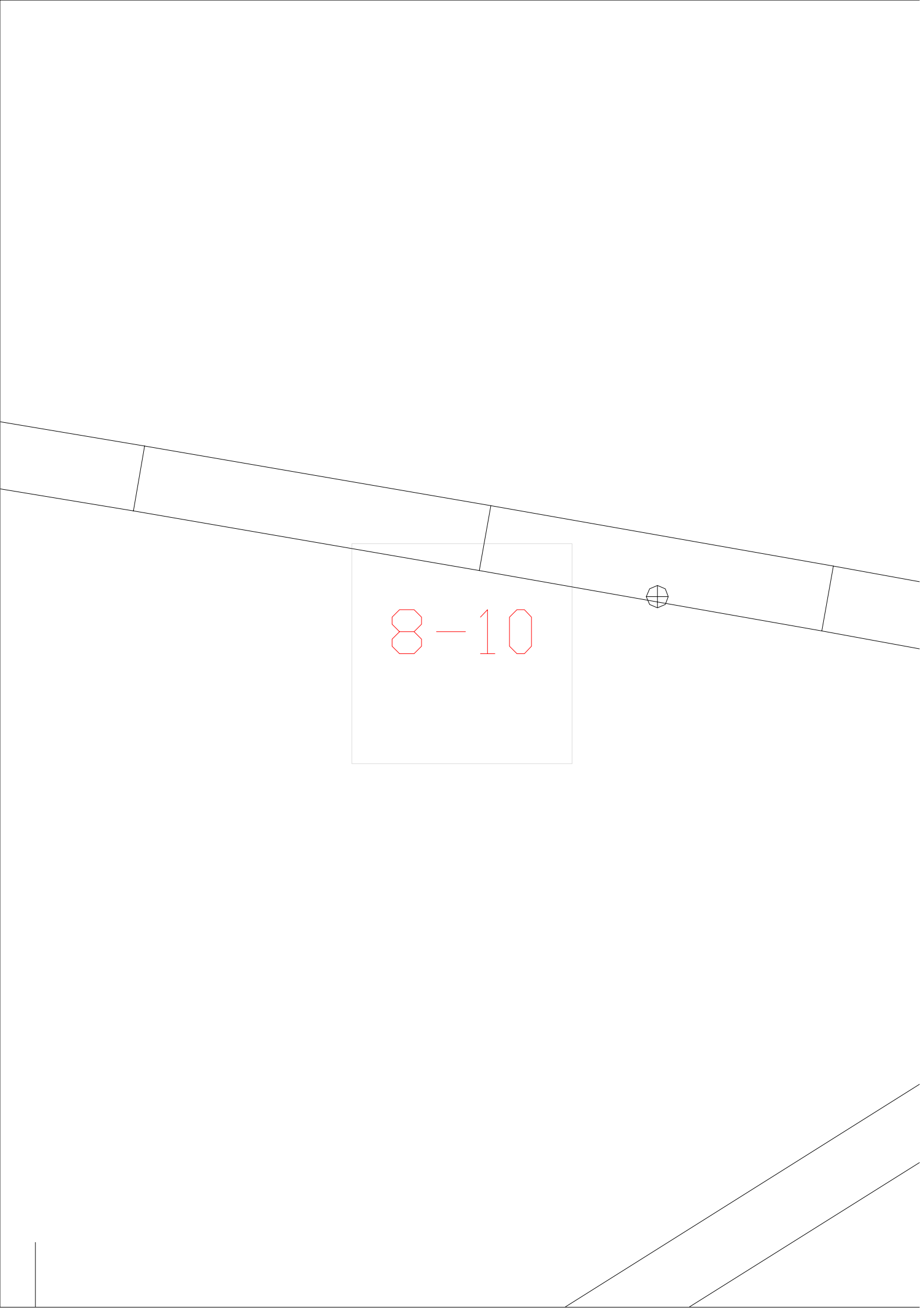

8-10

The image shows a technical drawing of a beam with a curved profile. The beam is divided into several segments by vertical lines. A rectangular box highlights a specific section of the beam, labeled '8-10' in red. To the right of this section, there is a small circular symbol with a cross inside. The drawing is set against a white background with a light gray grid.



8-11

The image shows a technical drawing of a tapered shaft. The shaft is oriented horizontally and tapers from left to right. It features a chamfered end on the right side, indicated by a small circle with a cross inside. A rectangular callout box is positioned over the shaft, containing the text '8-11' in red. The shaft is divided into several segments by vertical lines, suggesting different diameters or features. The drawing is a simple line drawing with no shading or color.

8-12

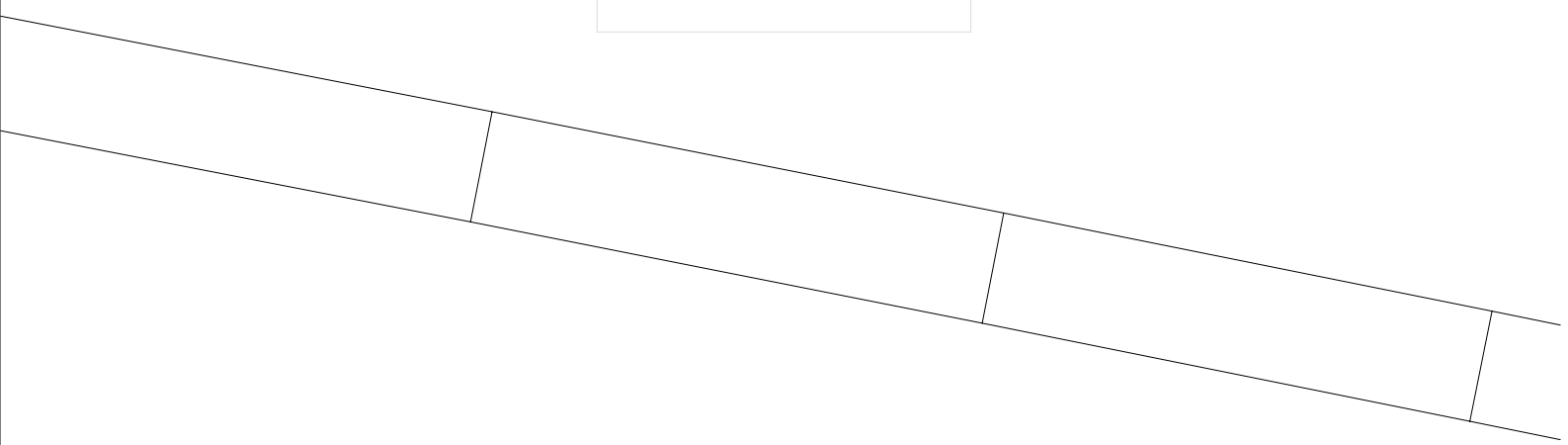

|

8-13



8-14

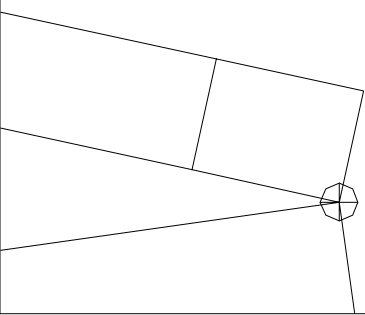

8-1

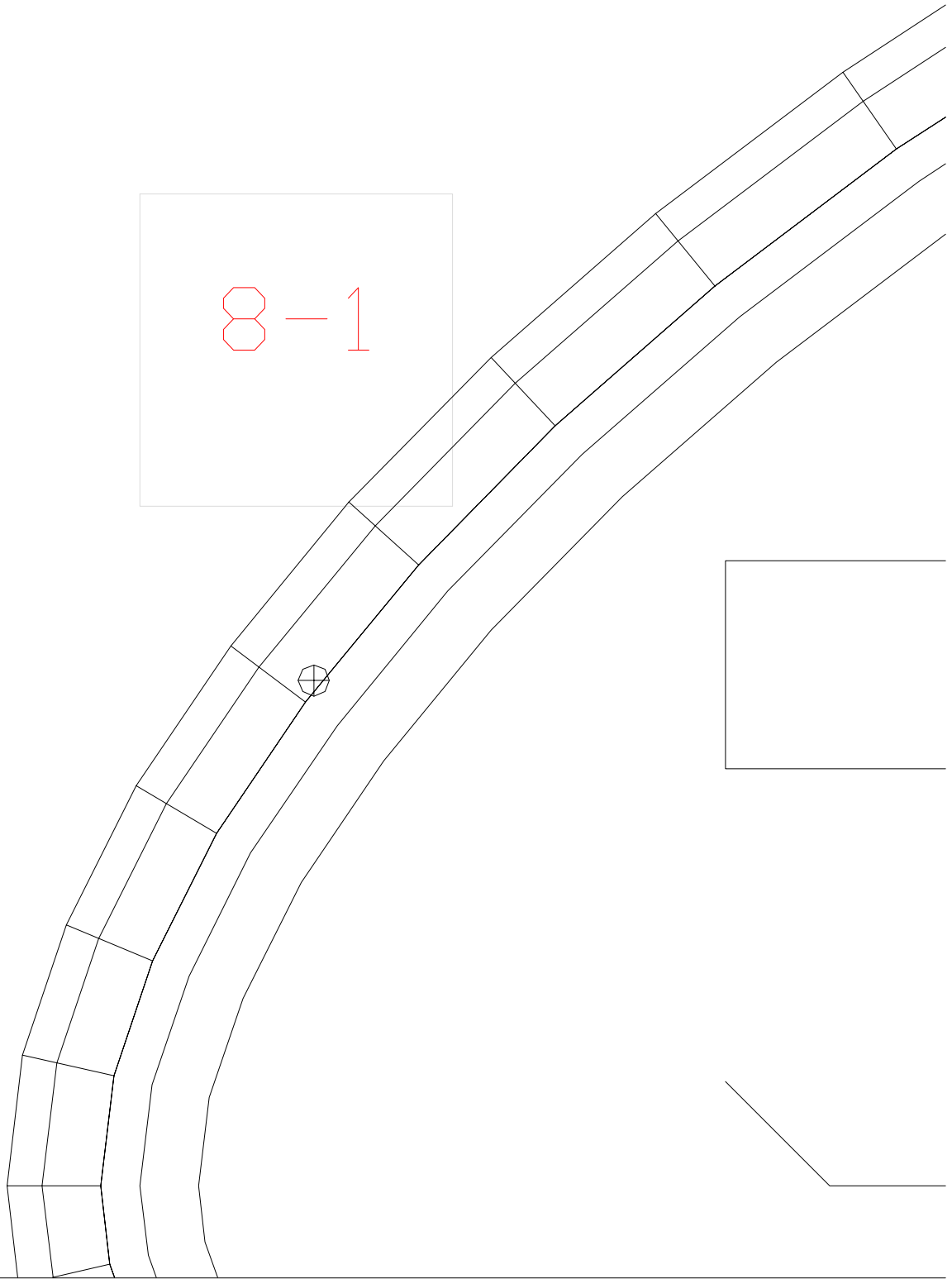

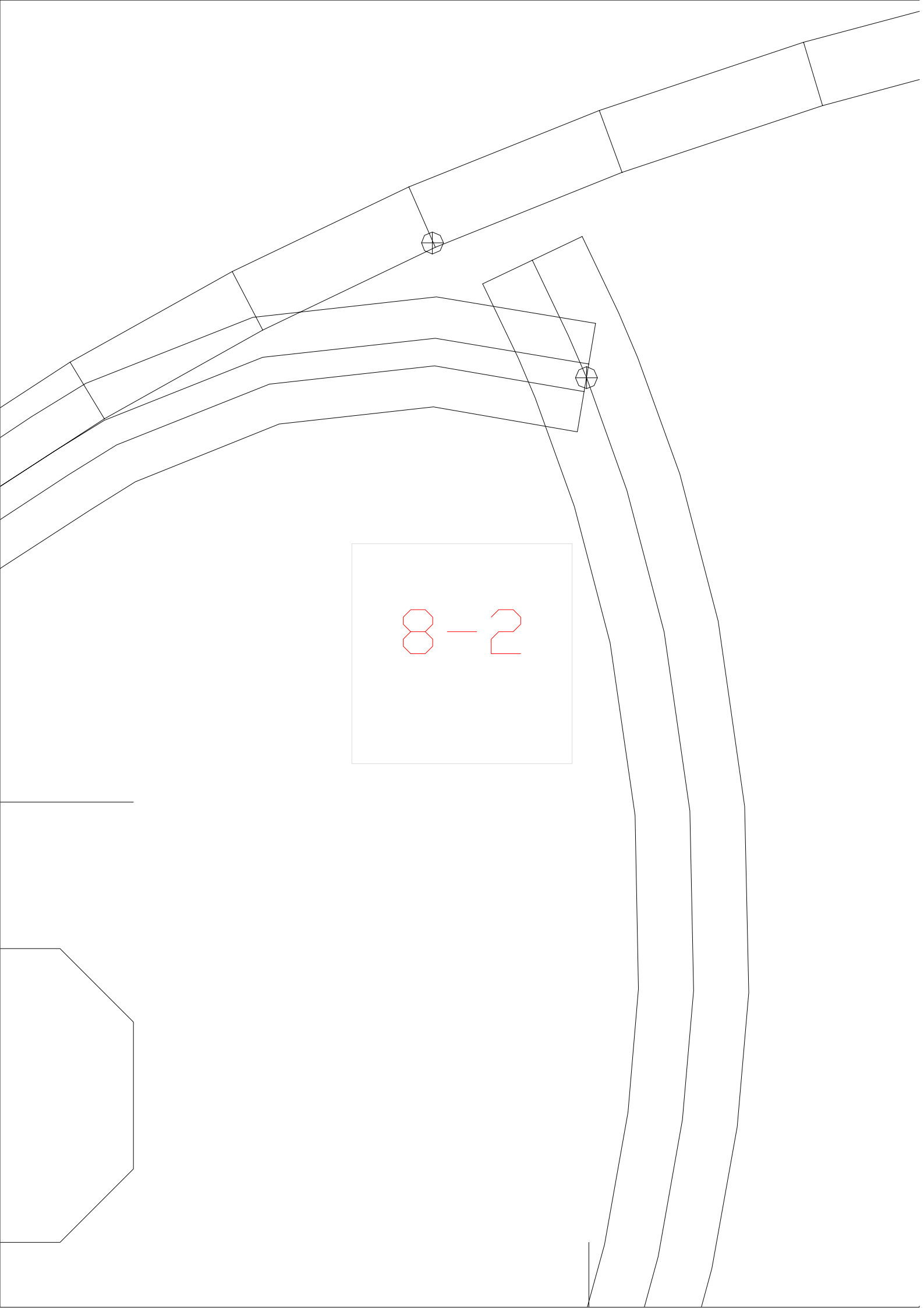

8-2

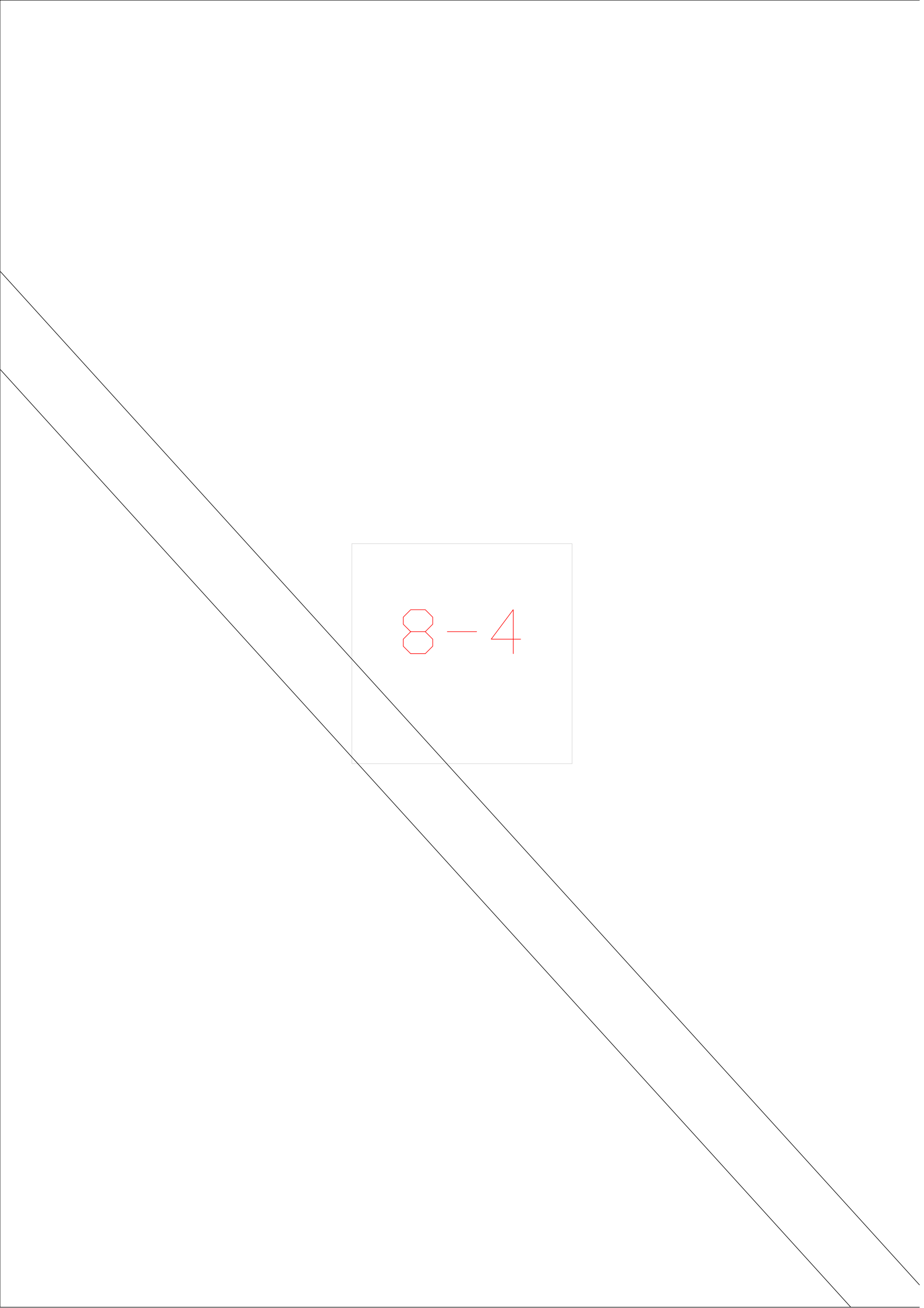

8-3

 $8 - 4$

8-5

8-6

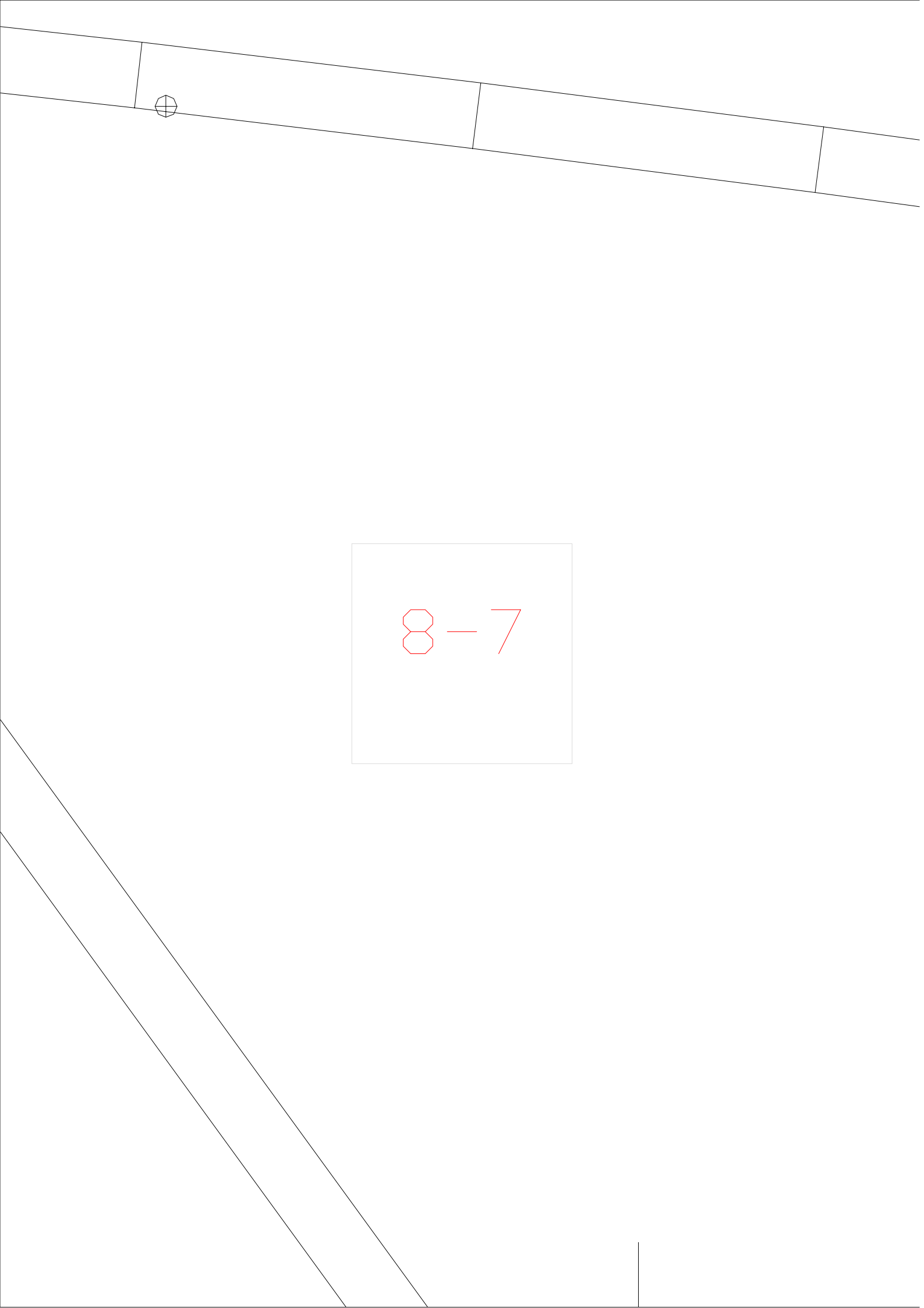

8-7

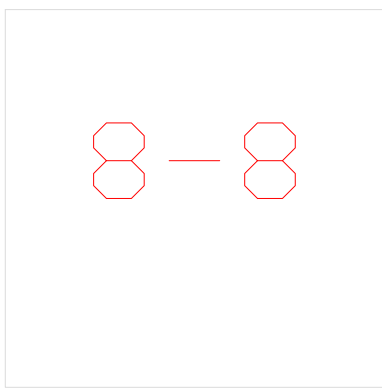
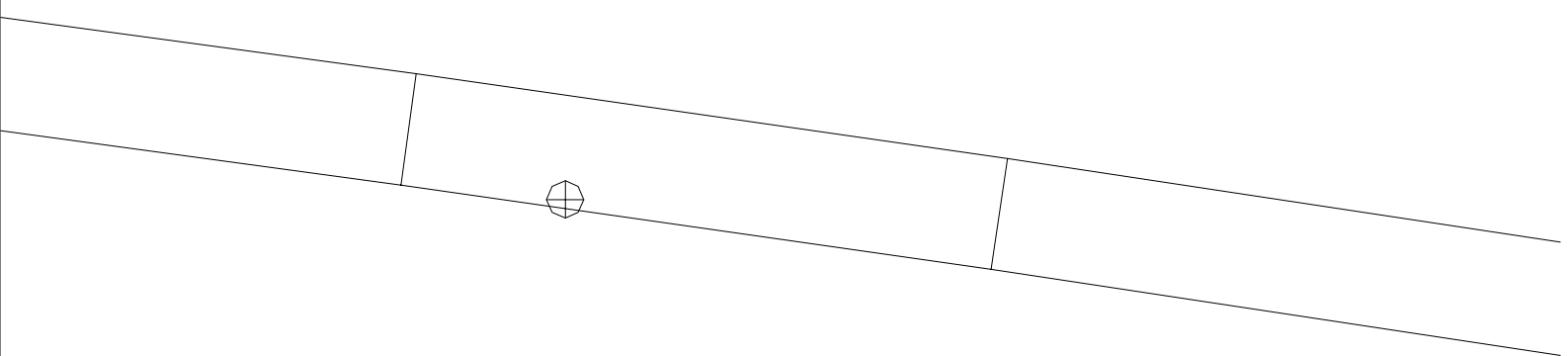

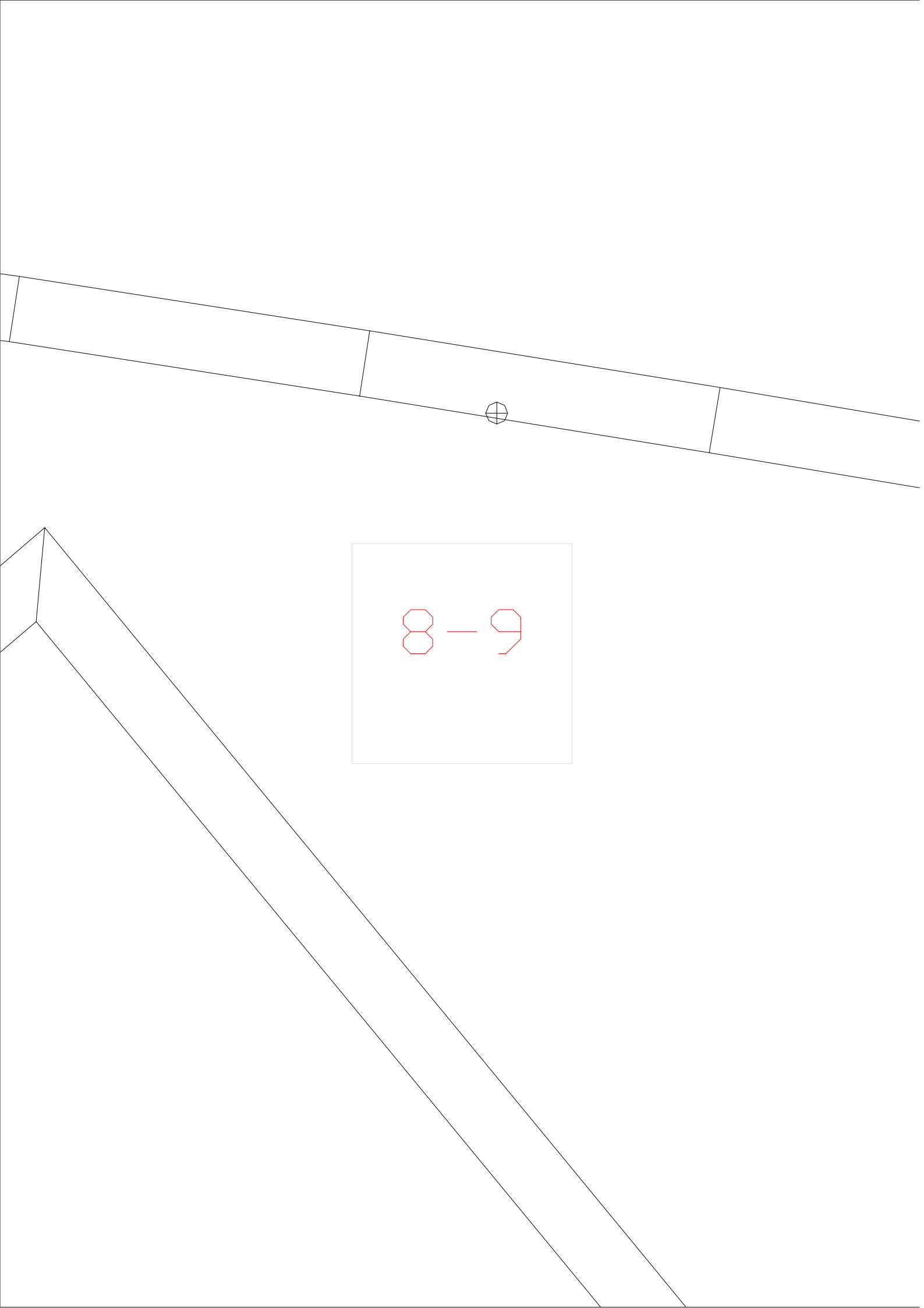

8-9

9-10

9-11

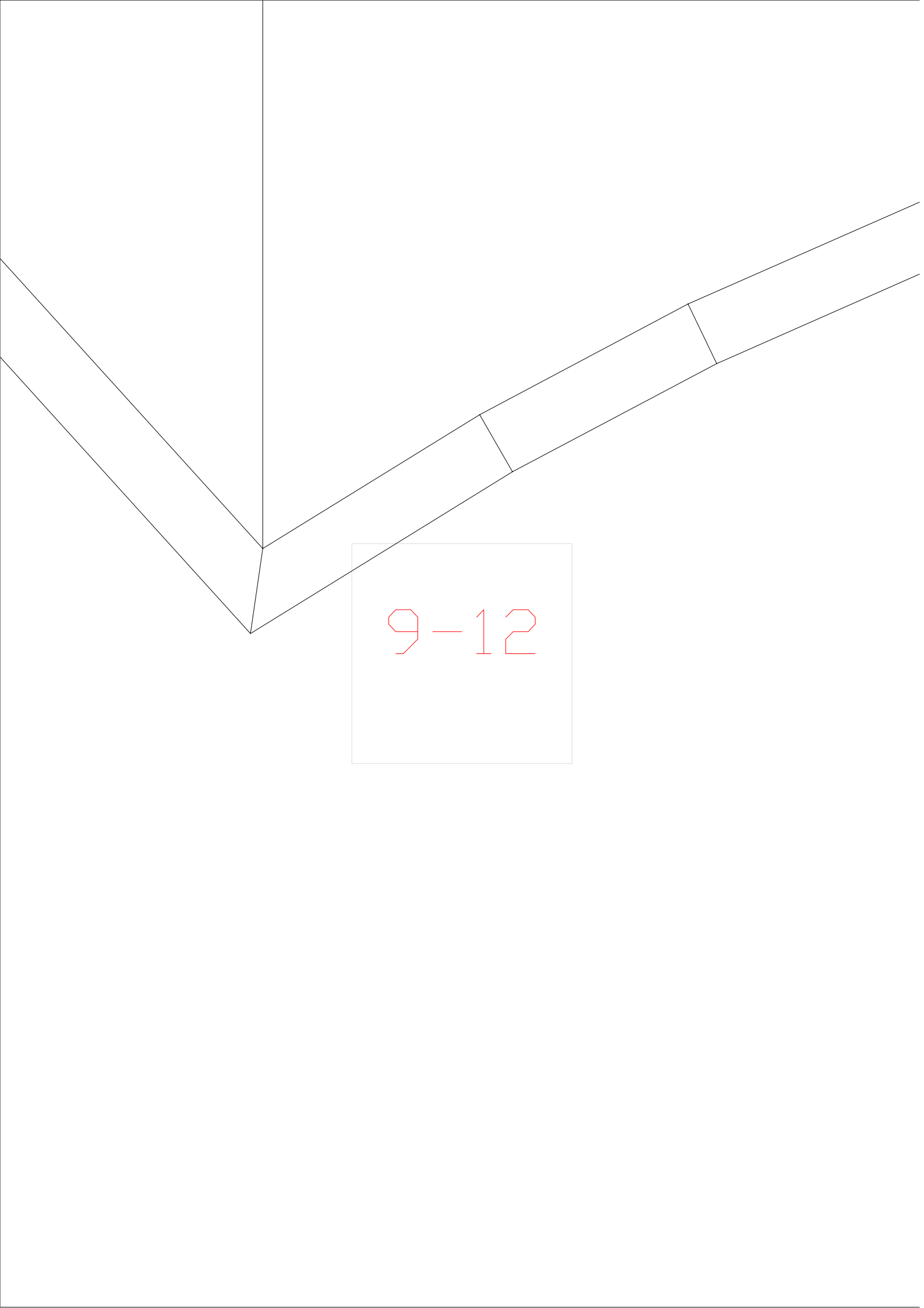

9-12

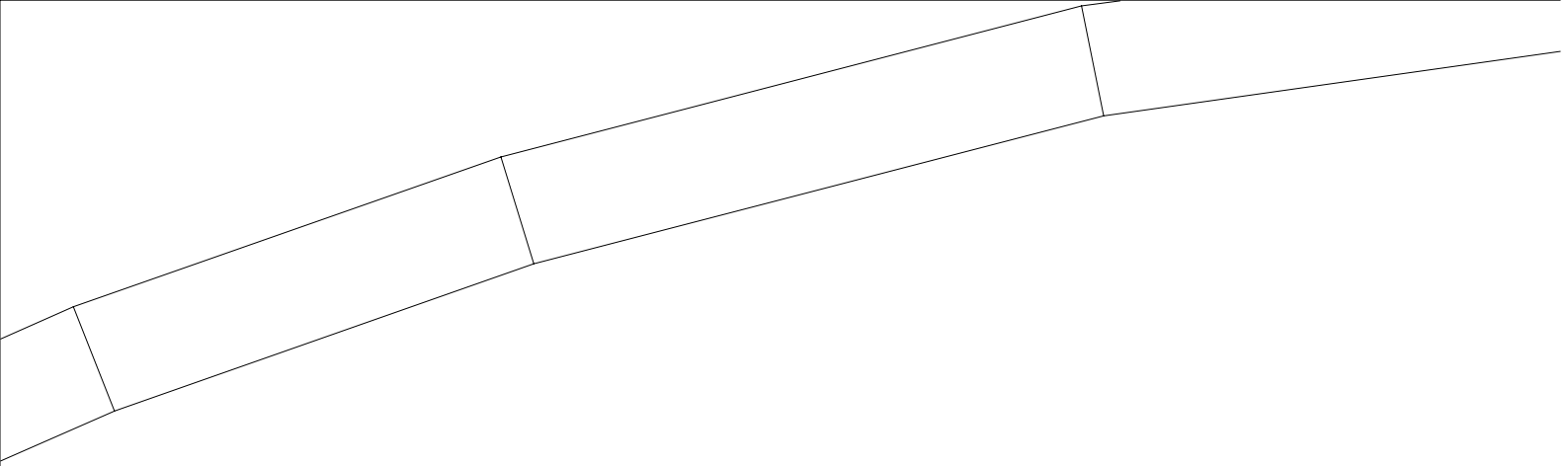

9-13

9-14

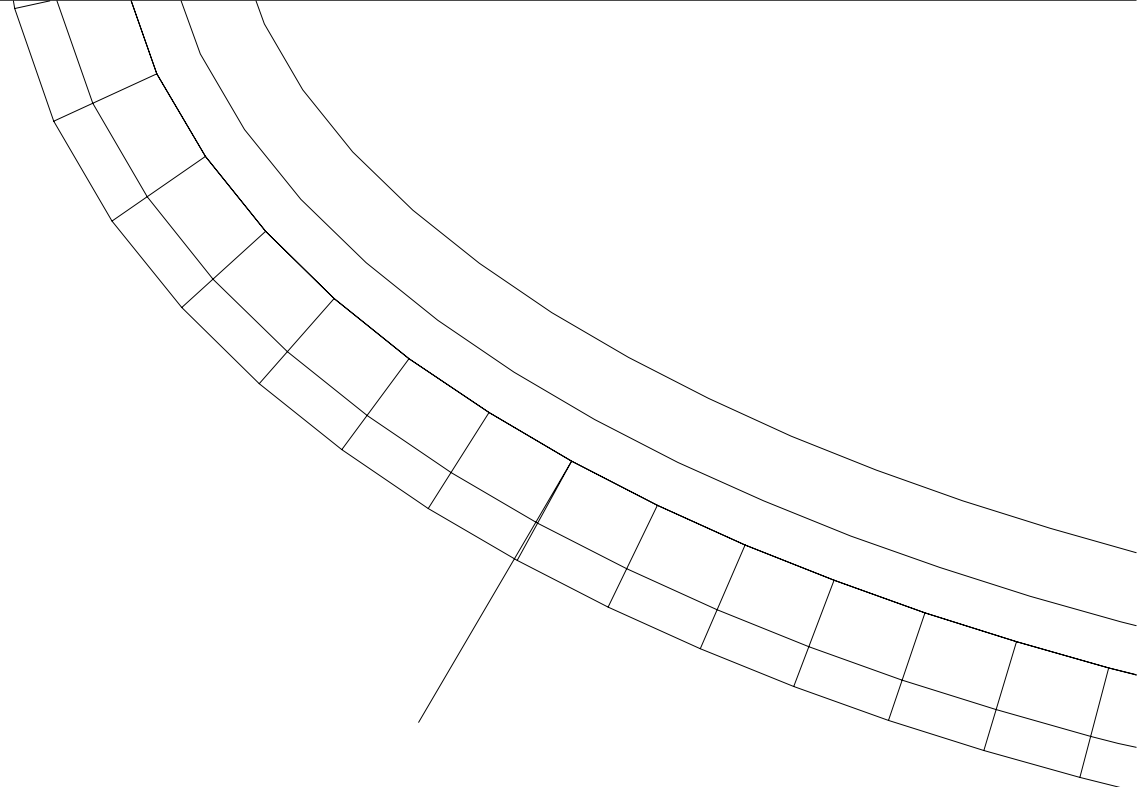

9-1

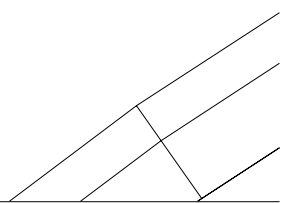

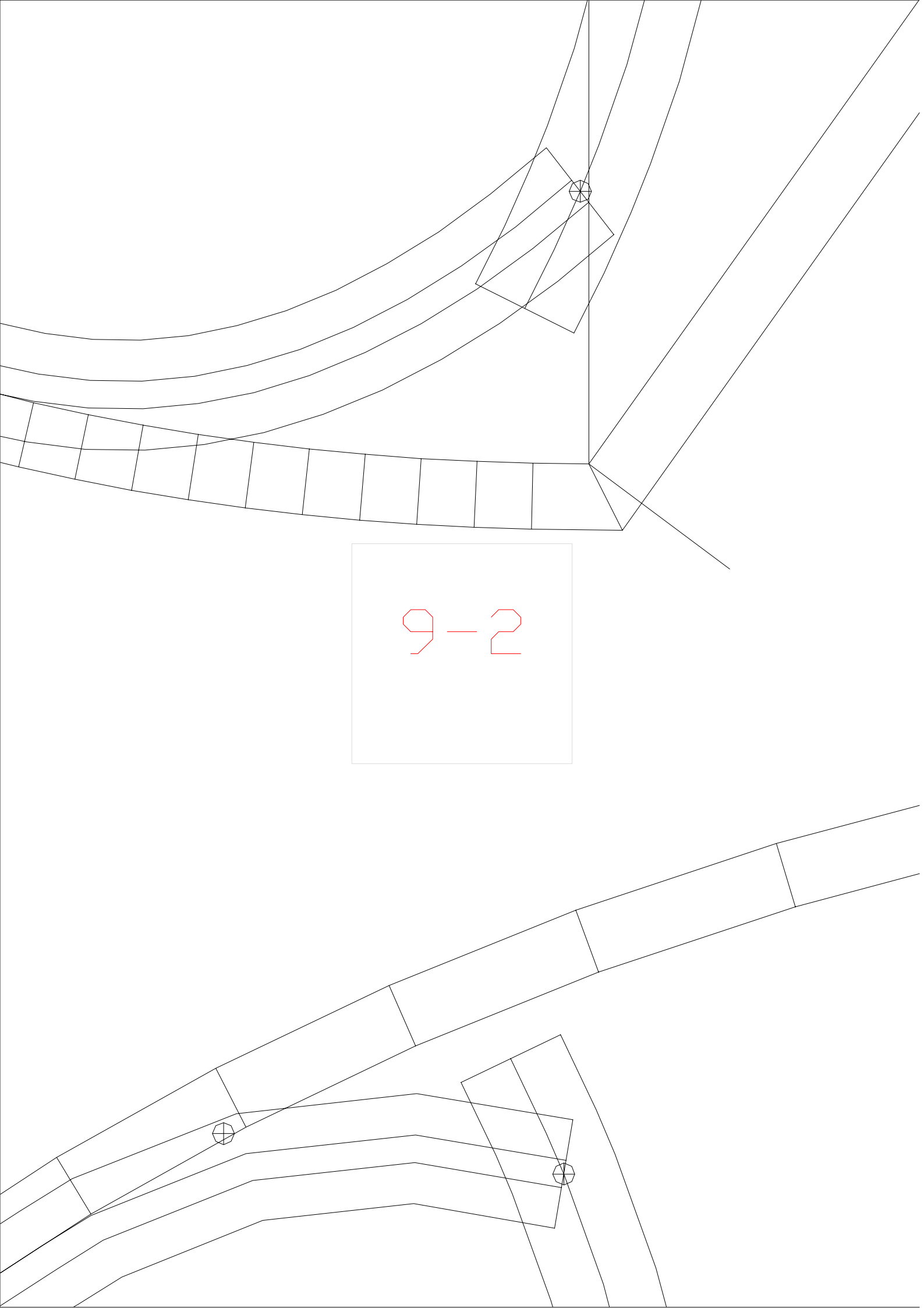

9-2

9-3



9-4



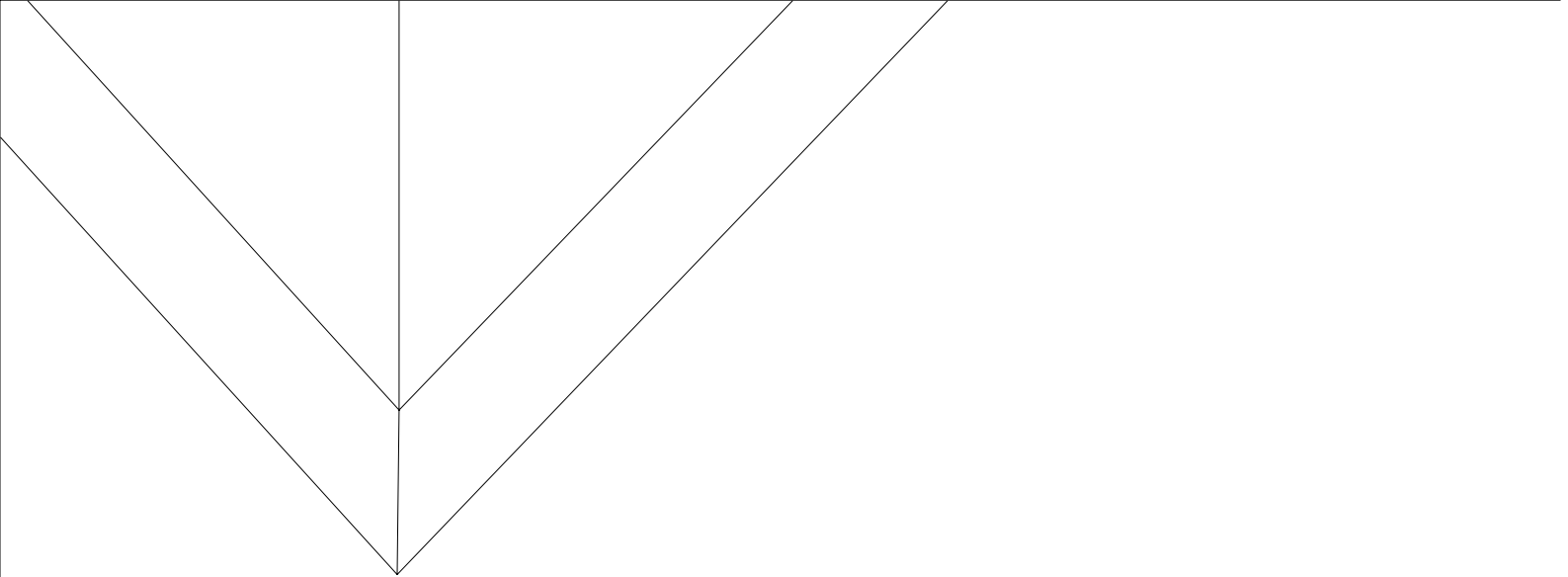

9-5

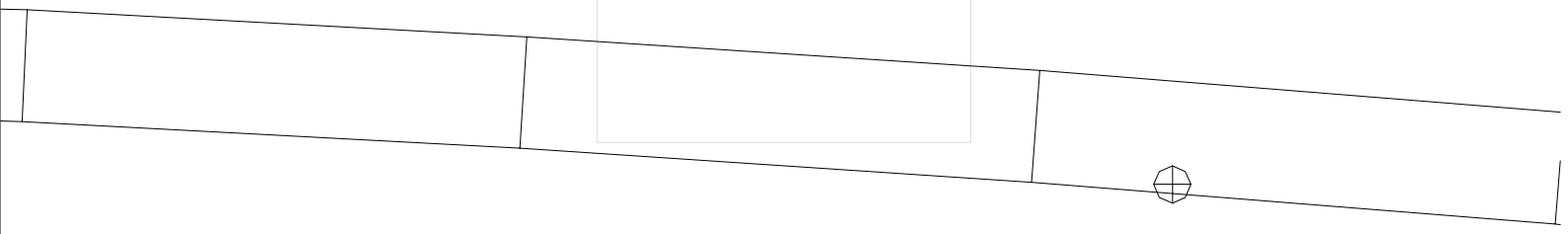

9-6

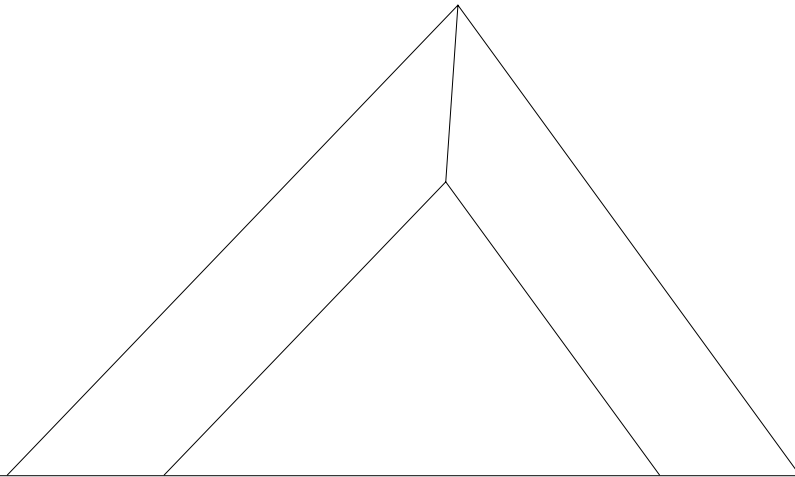

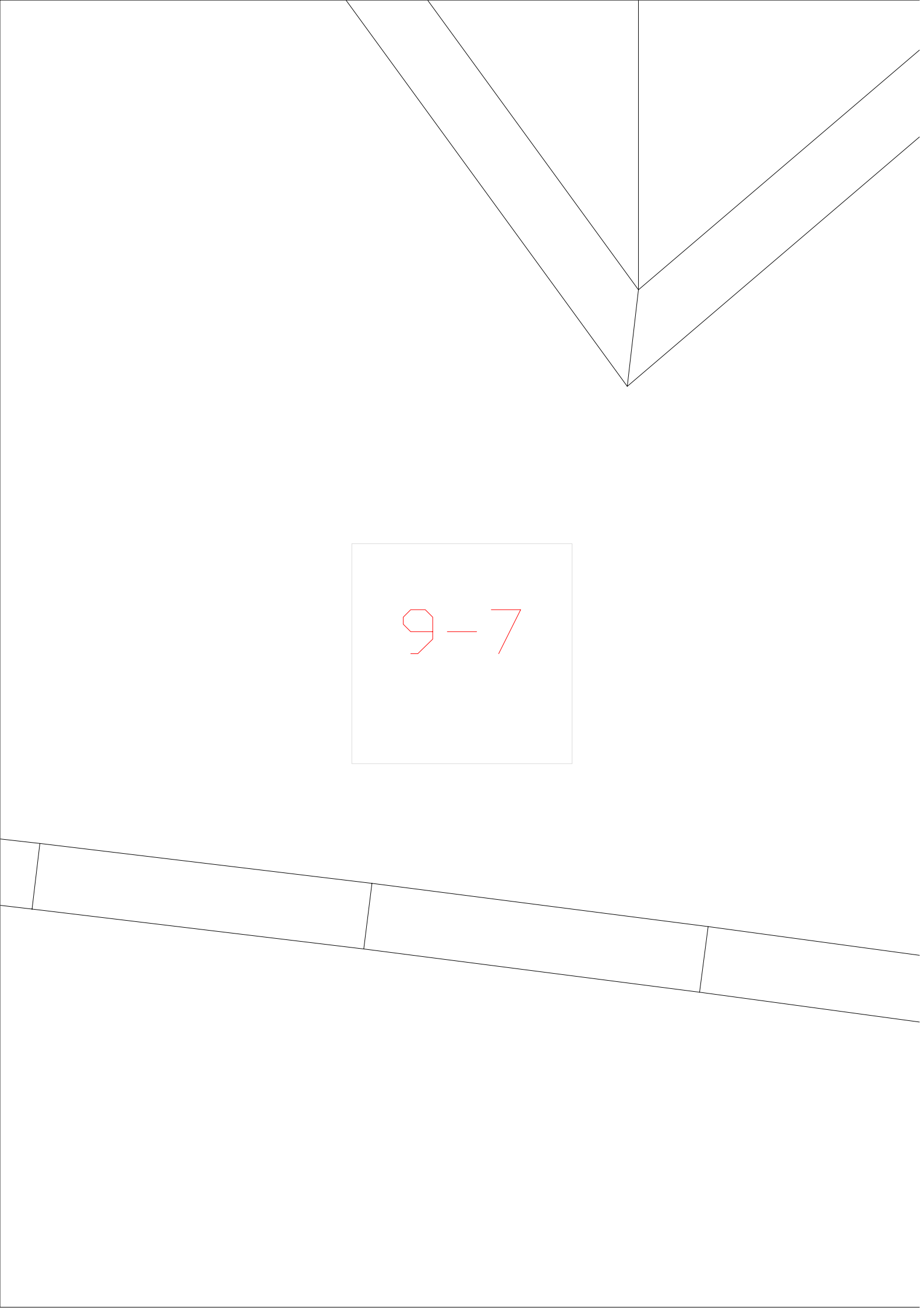

9-7

9-8



9-9



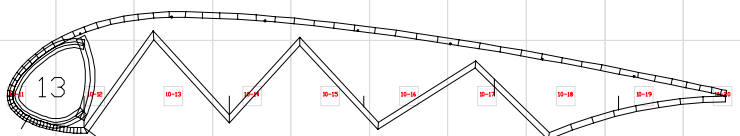
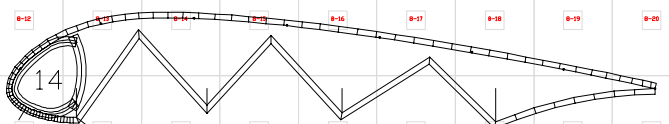
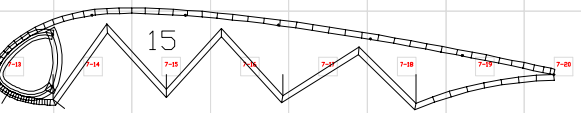
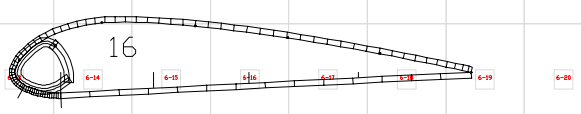
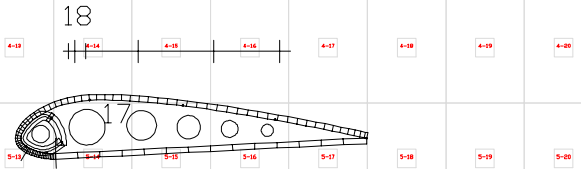
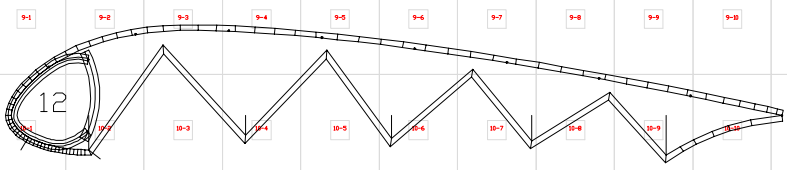
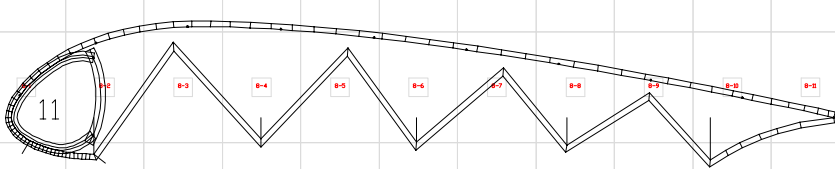
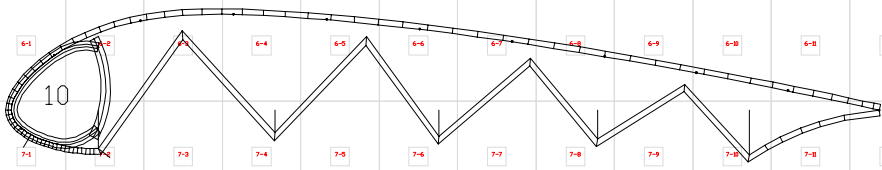
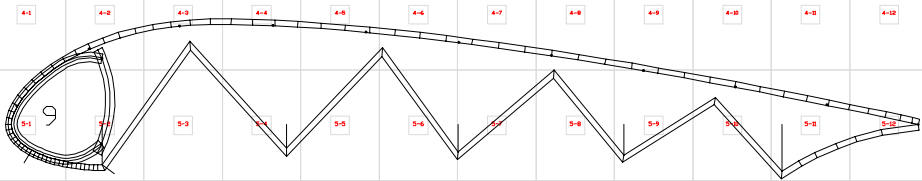
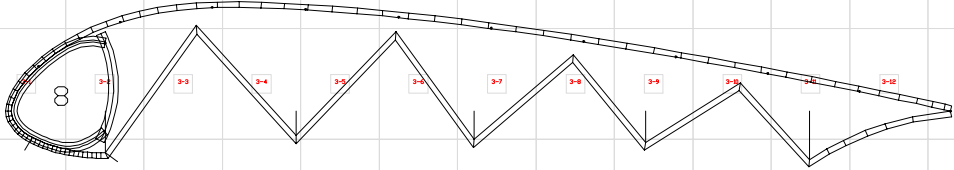
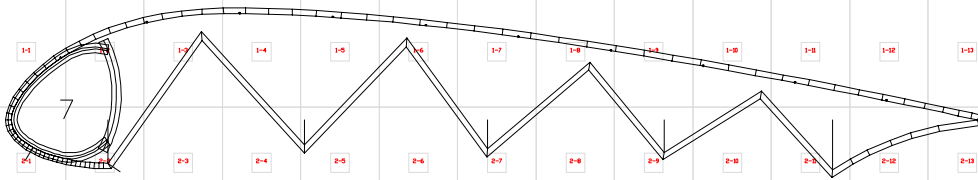

11-1 11-2 11-3 11-4 11-5 11-6 11-7 11-8 11-9 11-10 11-11 11-12 11-13 11-14 11-15 11-16 11-17 11-18 11-19 11-20

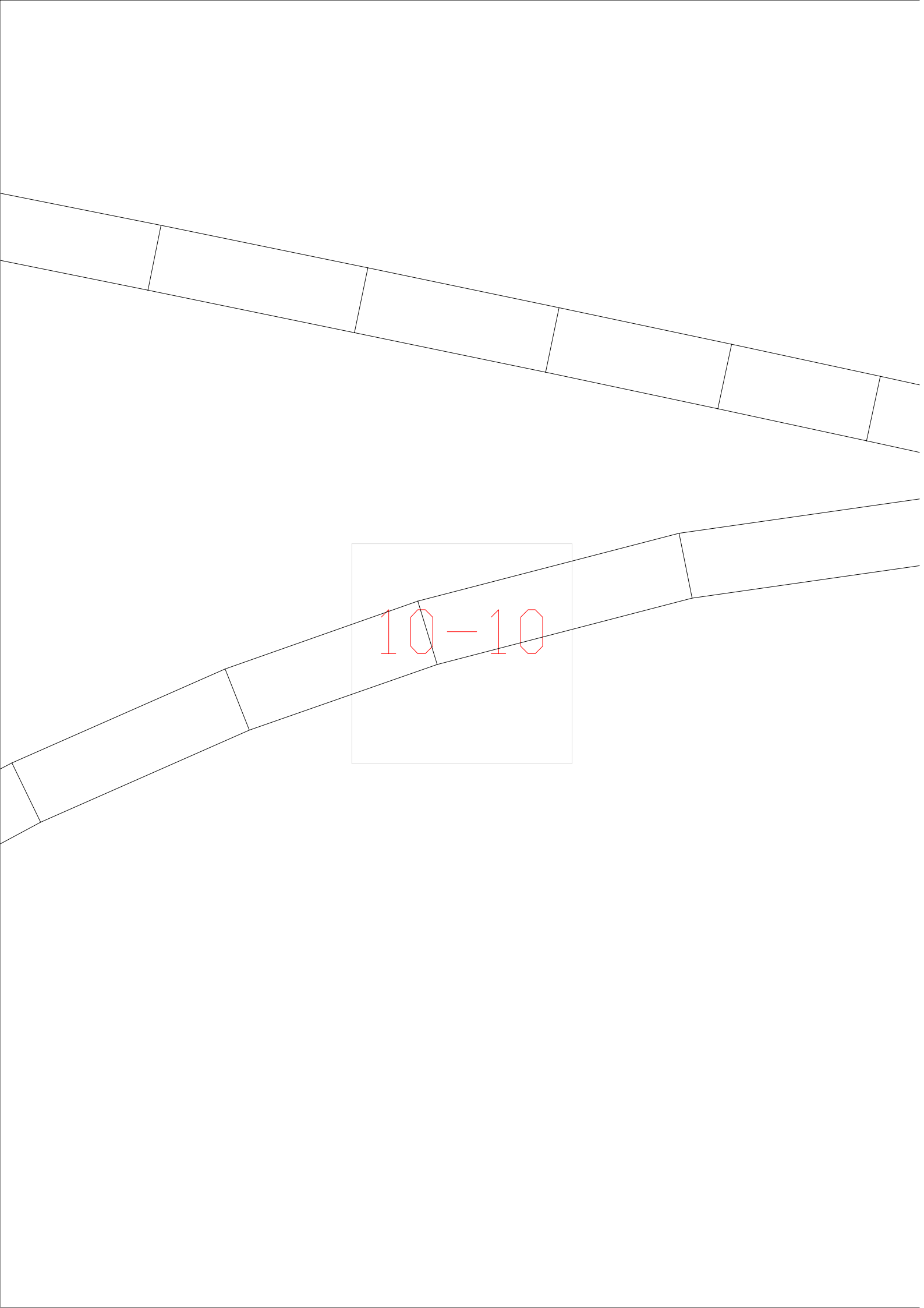

10-10

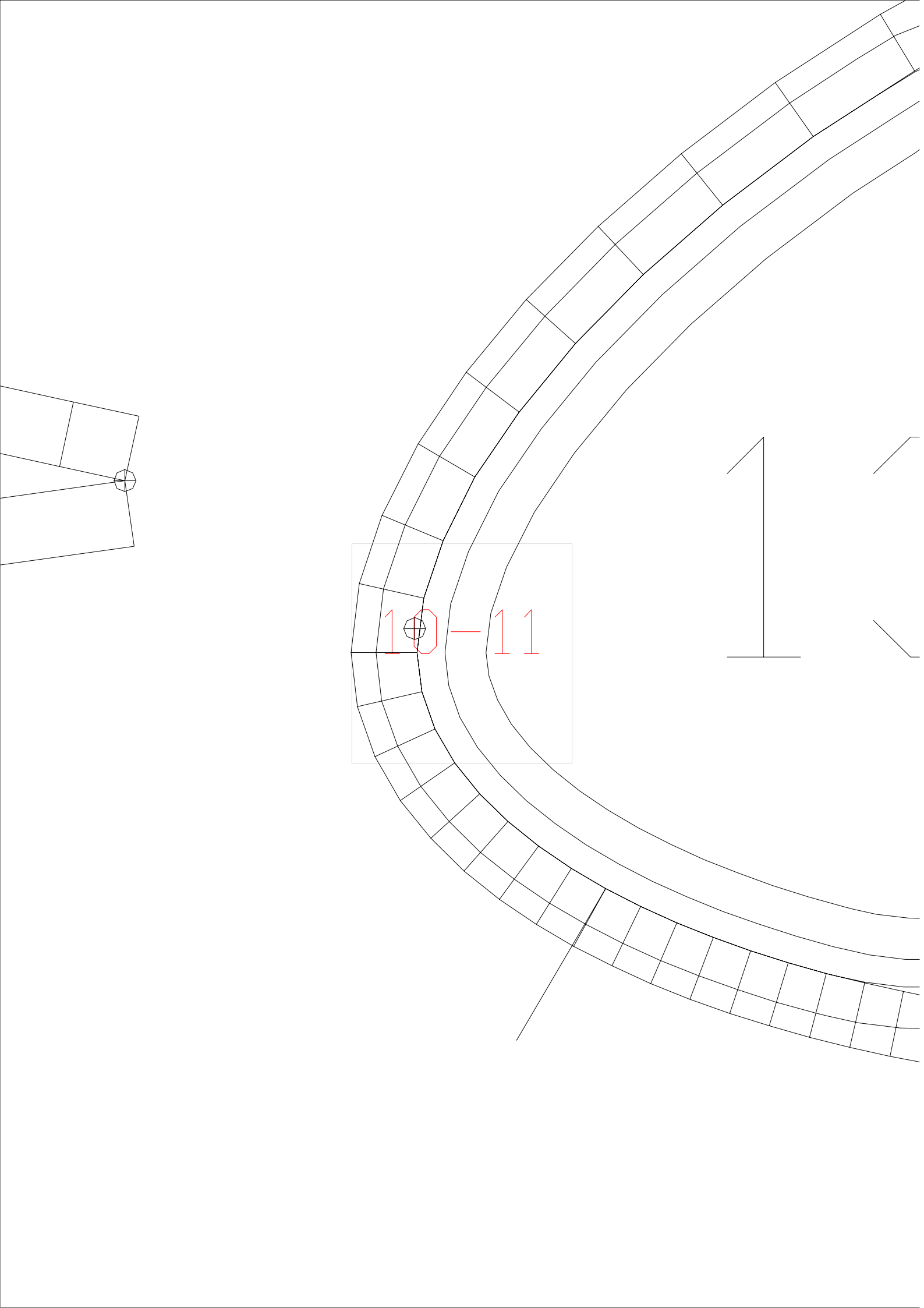

10-11

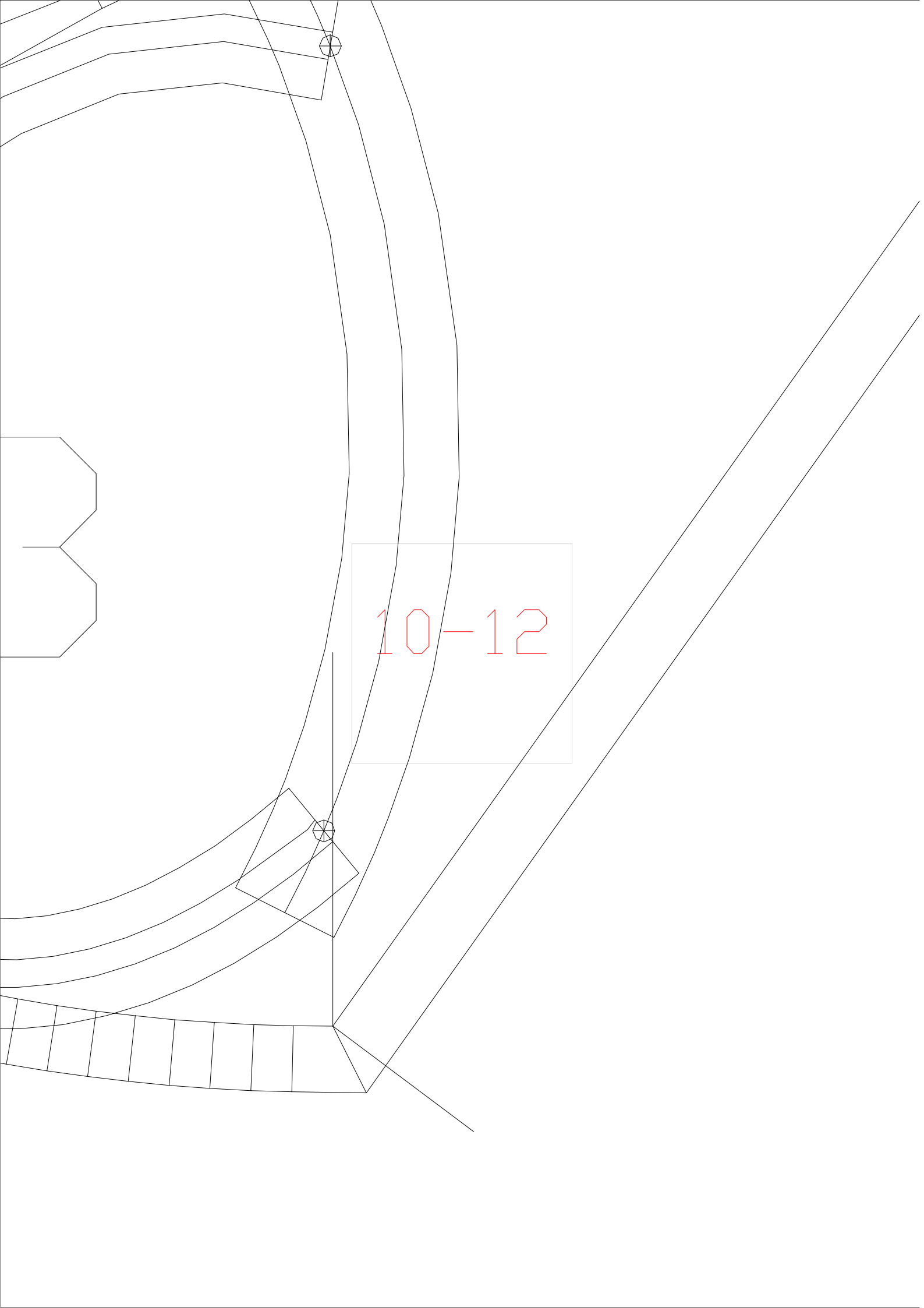

10-12



10-13

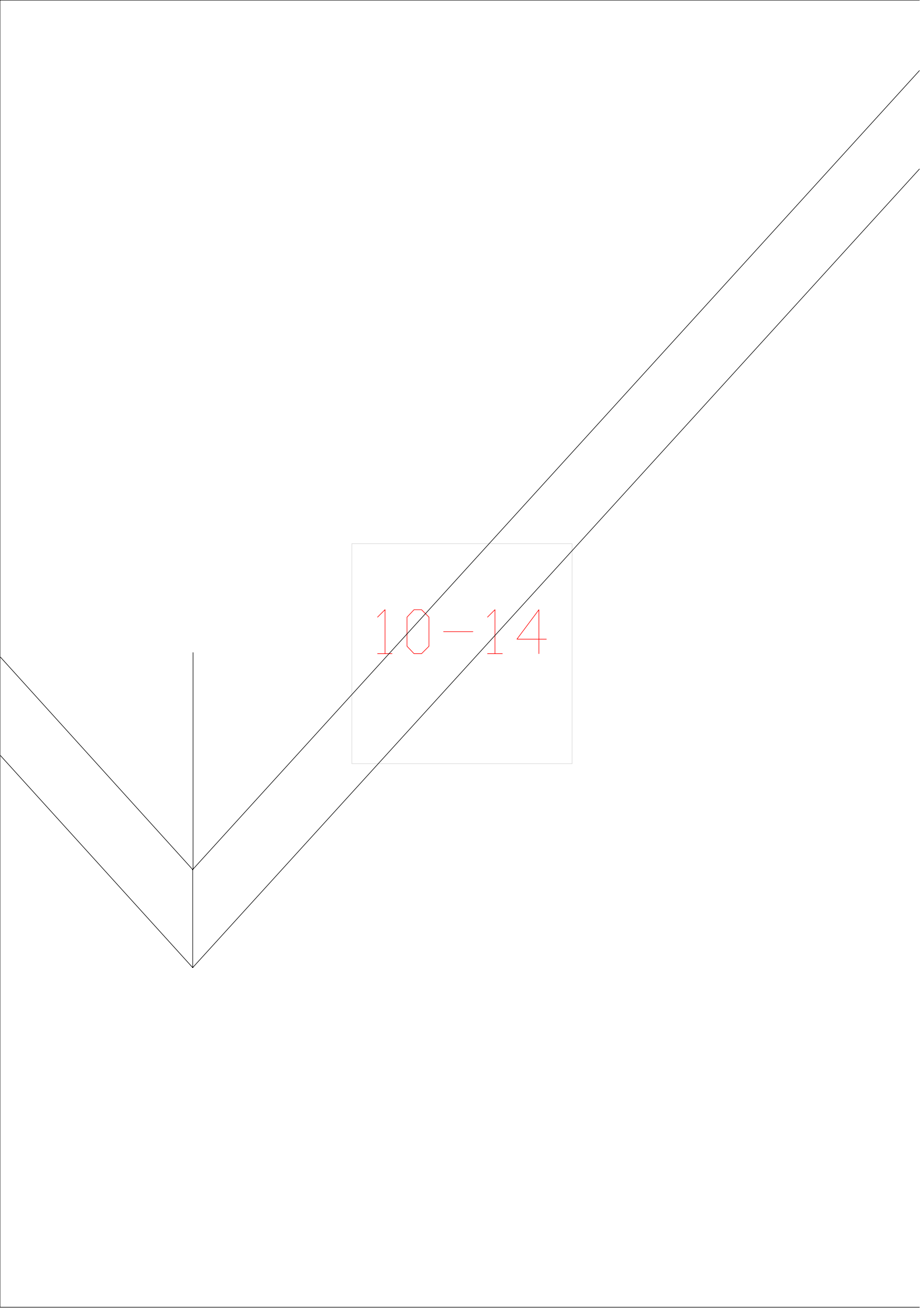

10-14



10-15



10-16

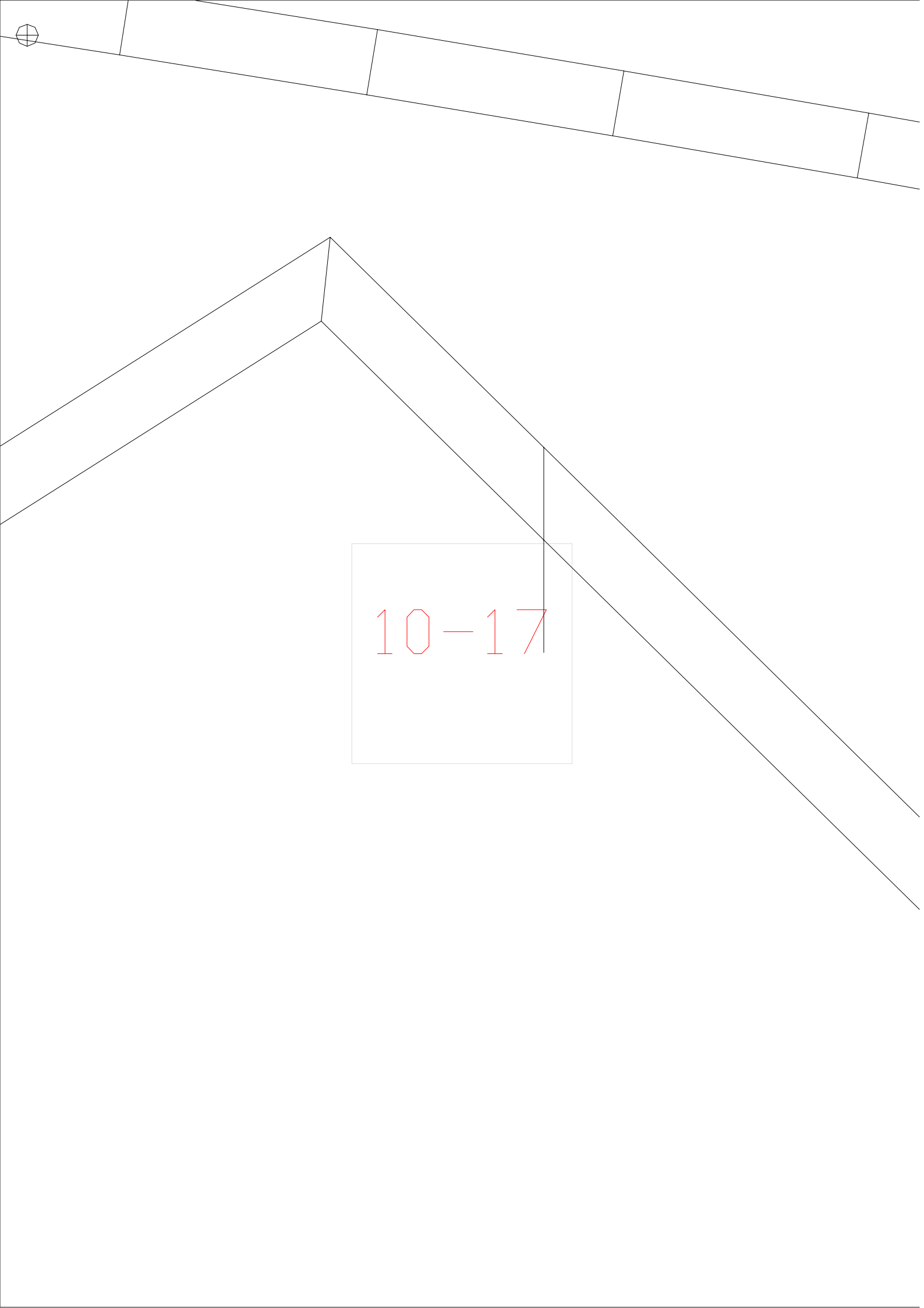

10-17

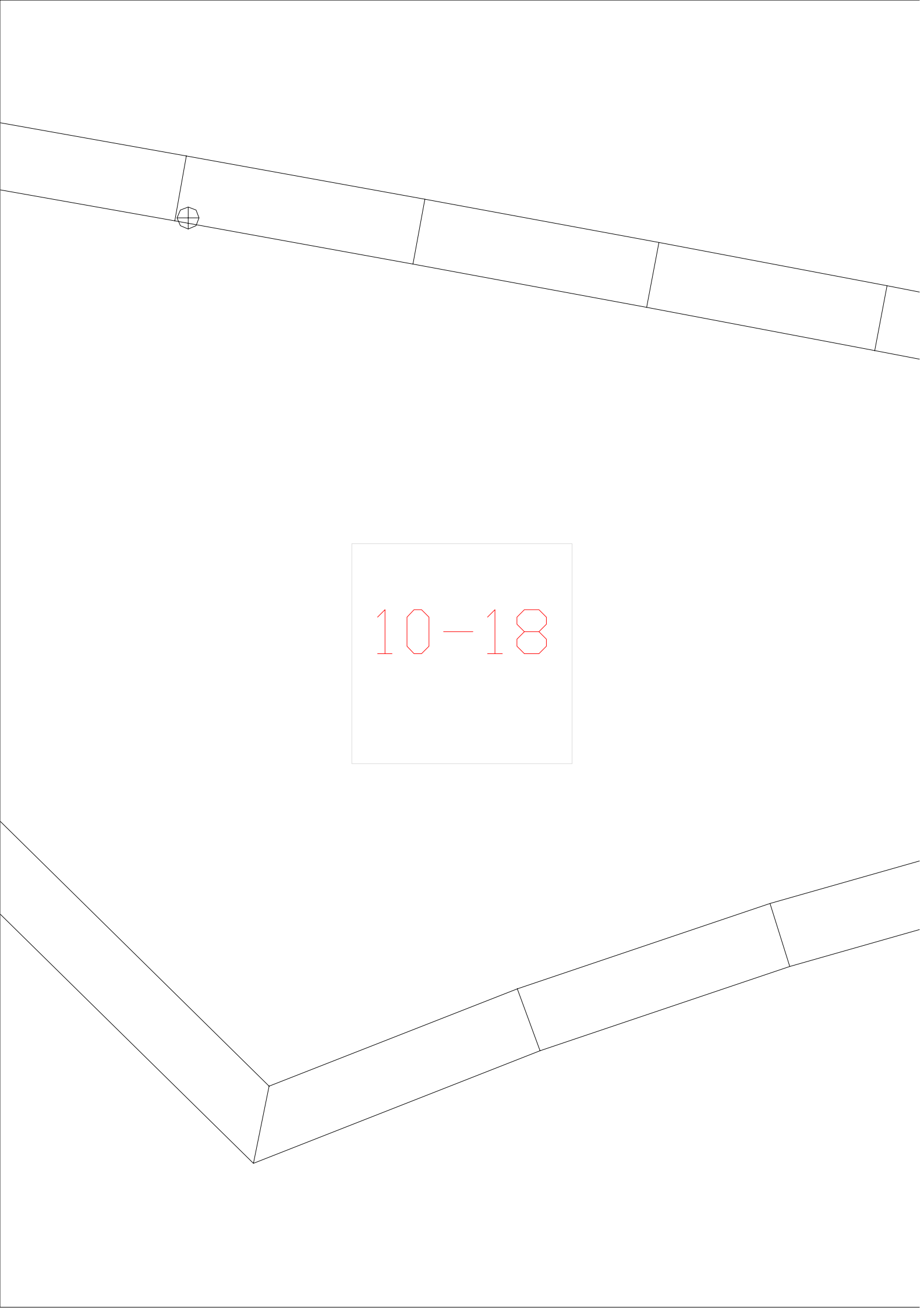

10-18

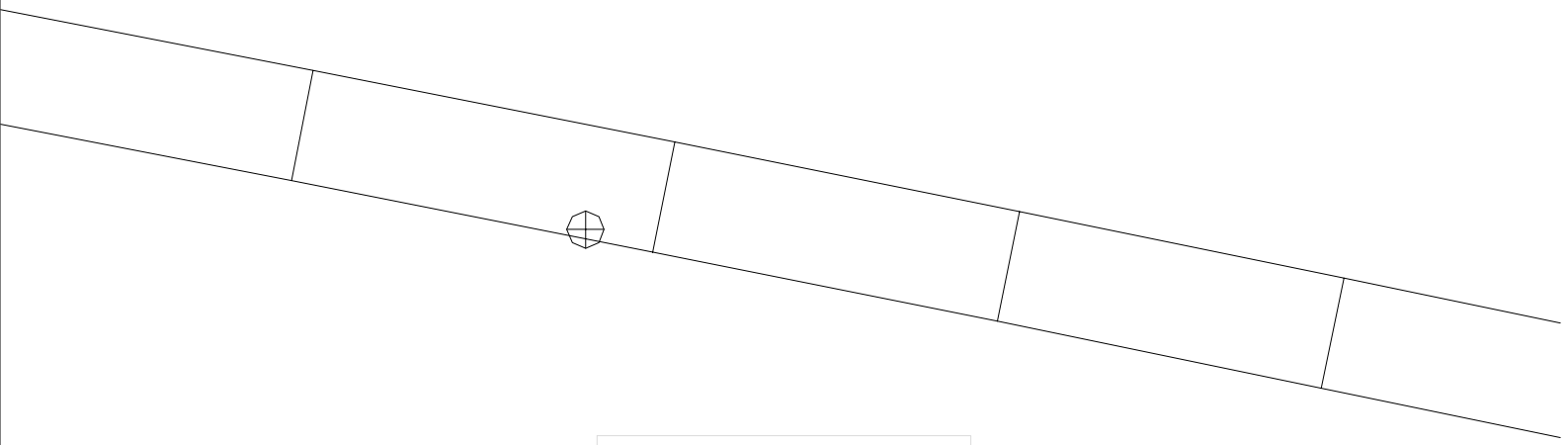

10-19

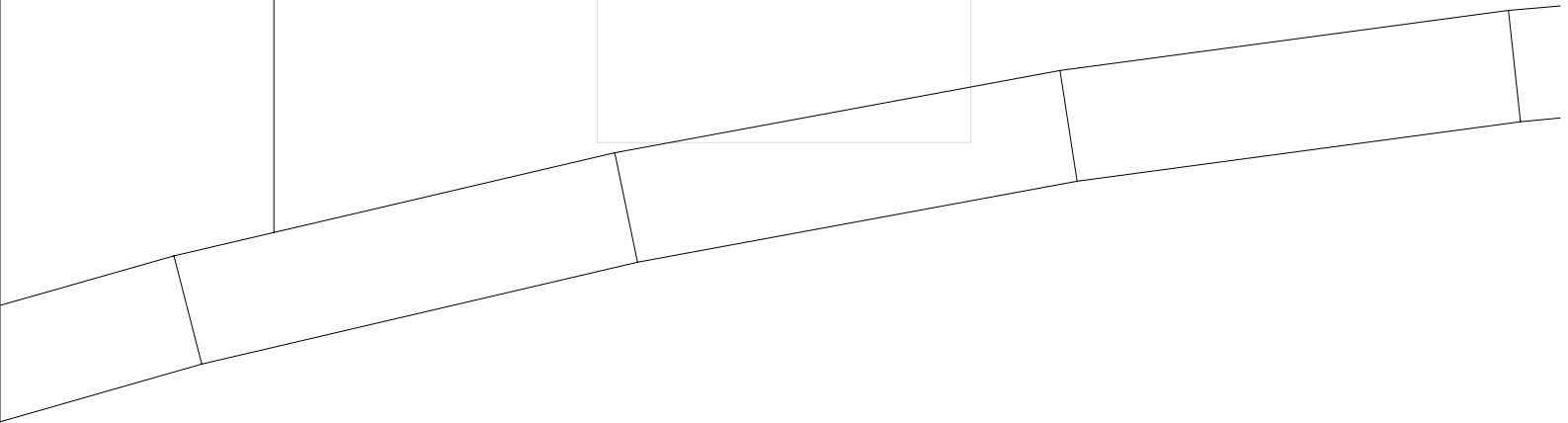

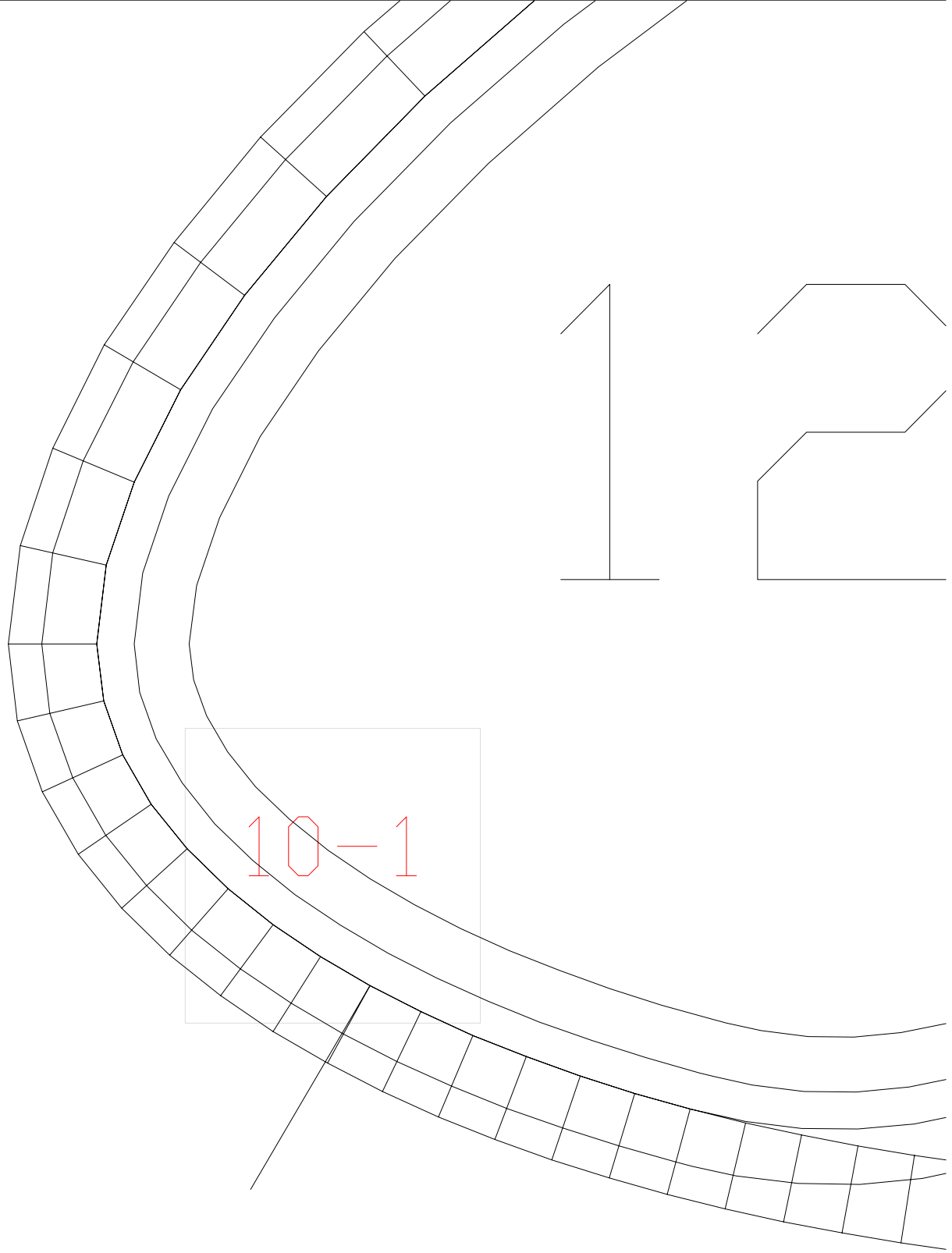

10-1

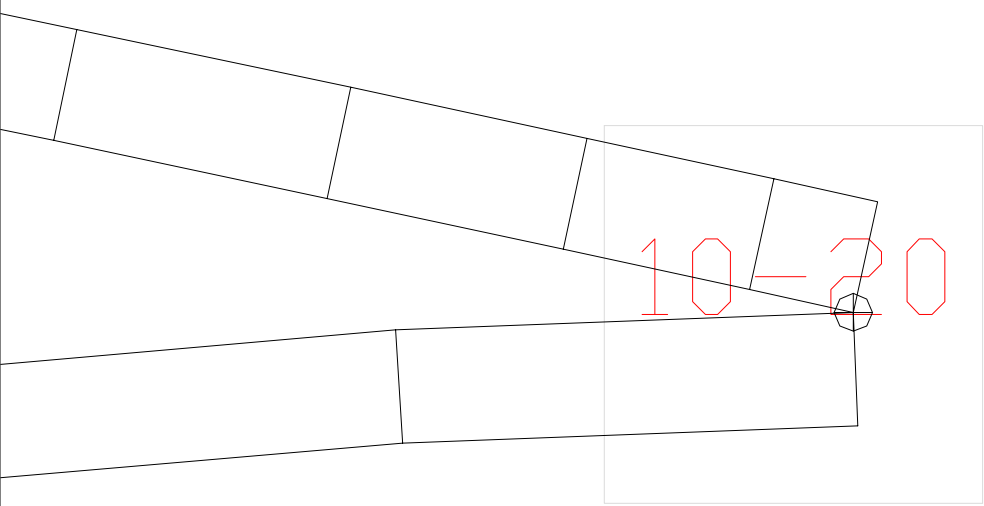

10-20

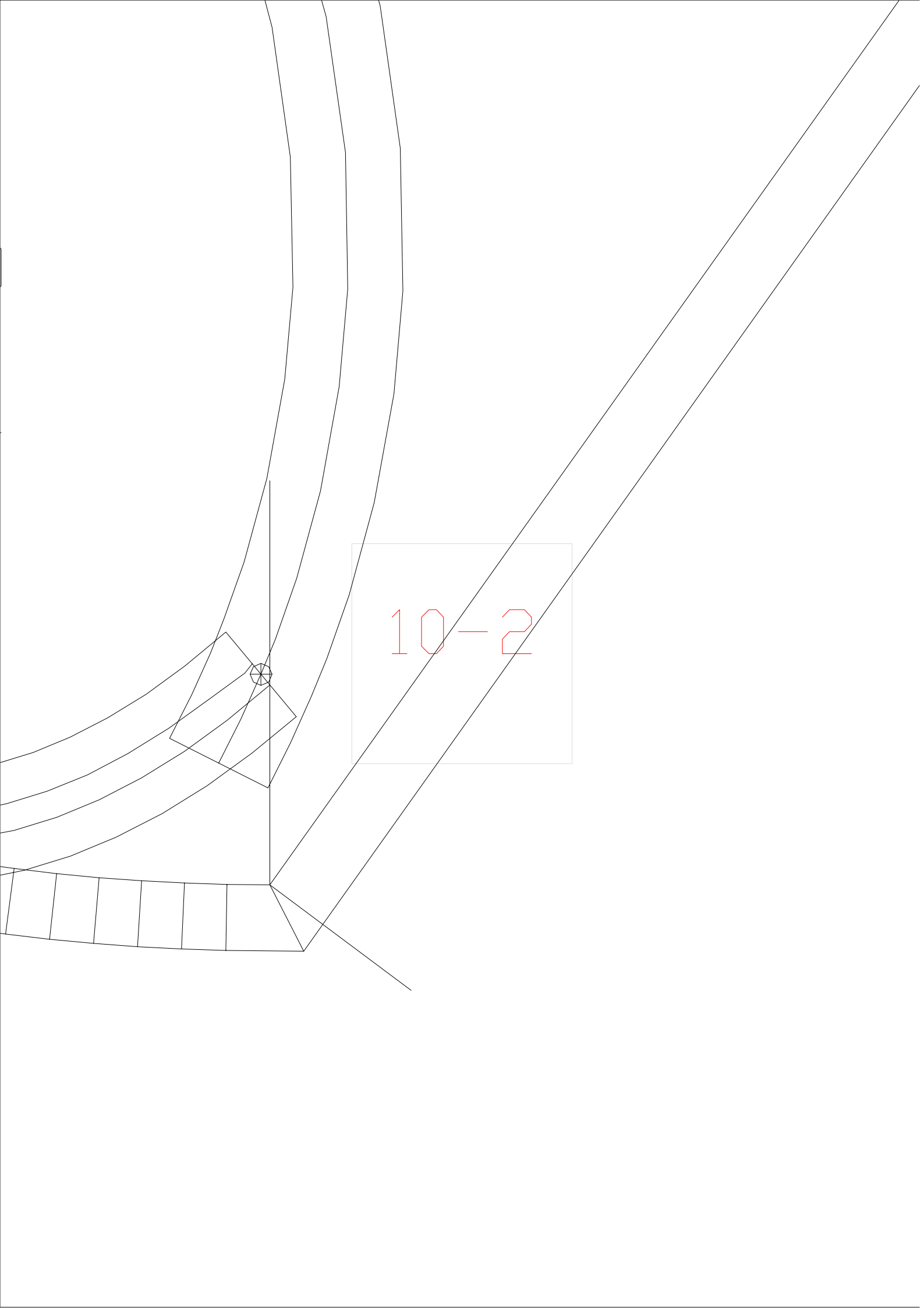

10-2

10-3

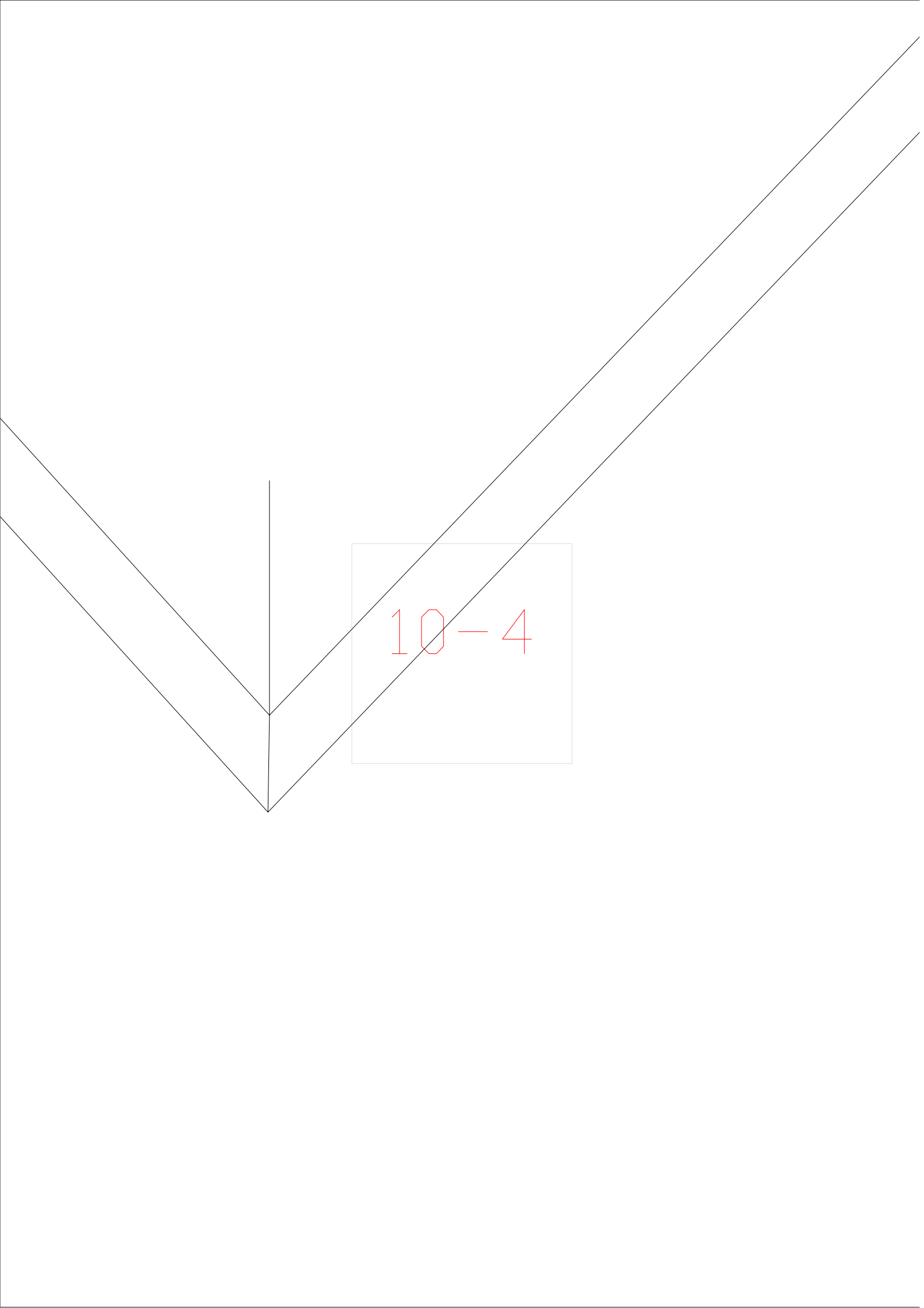

10-4

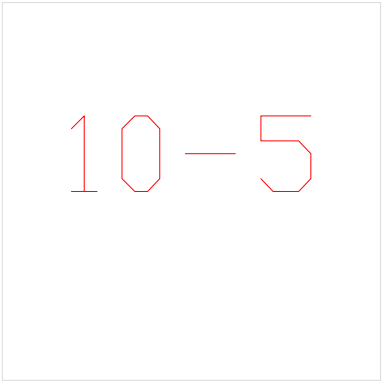
 $10-5$

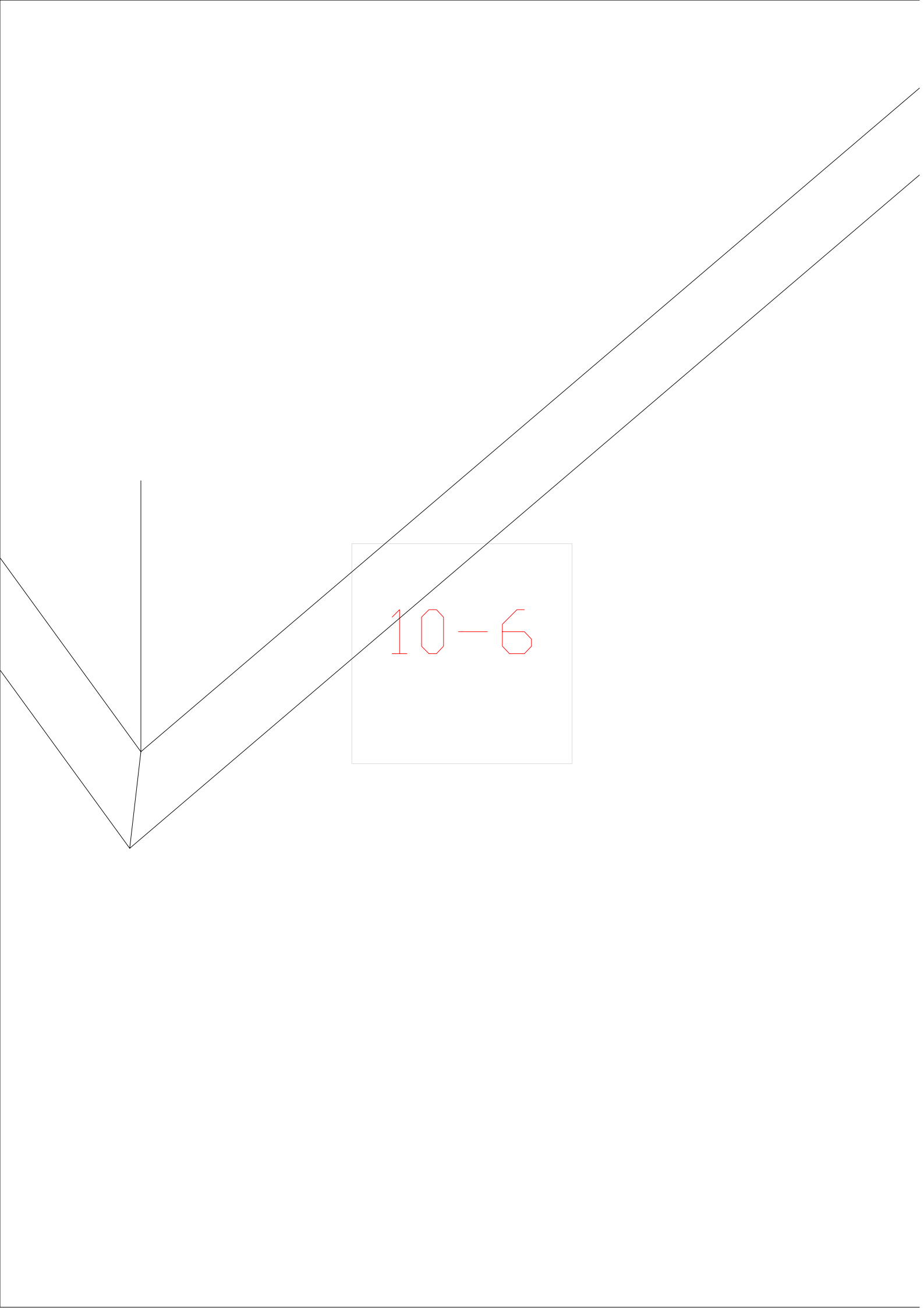

10-6

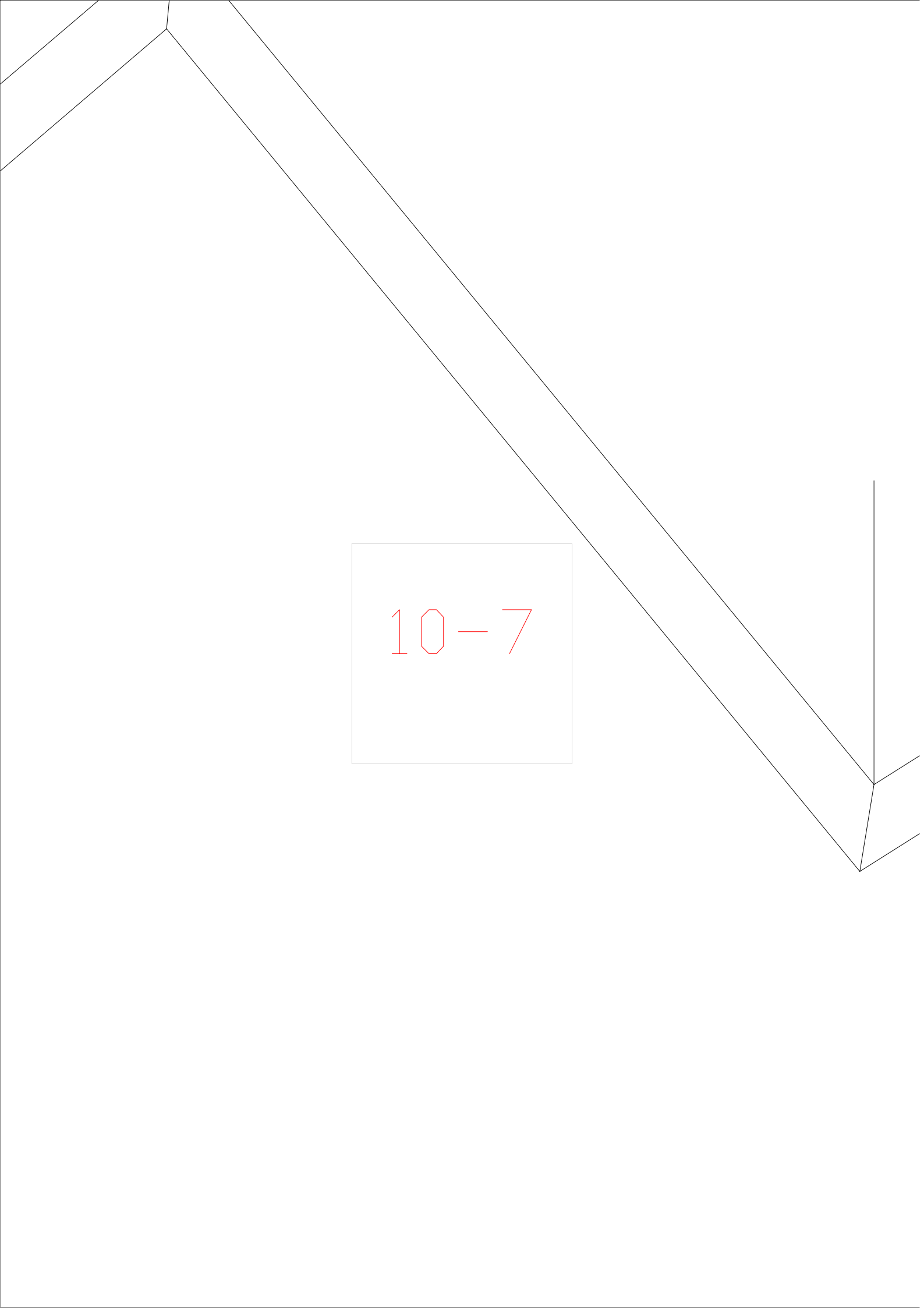

10-7

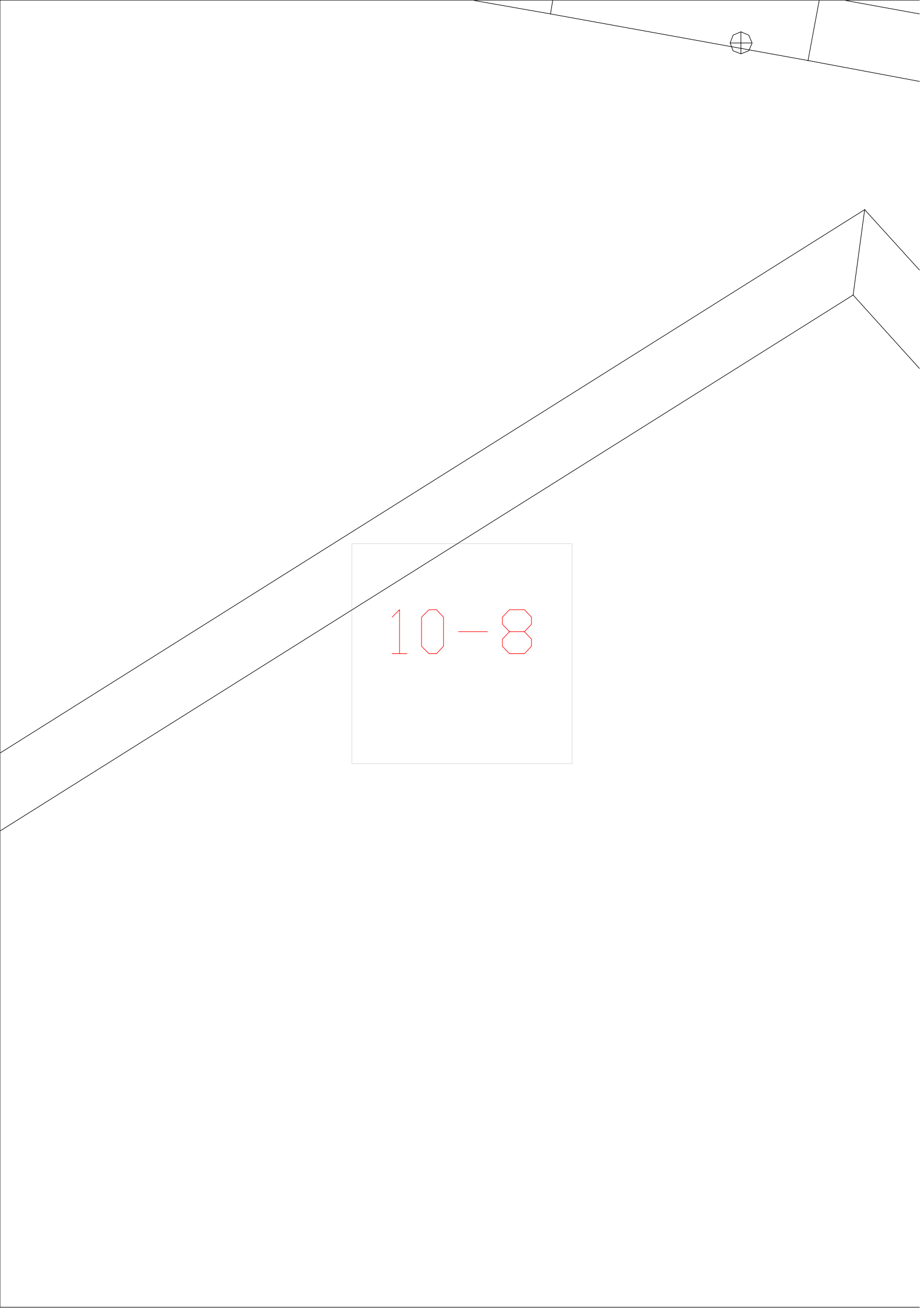

10-8

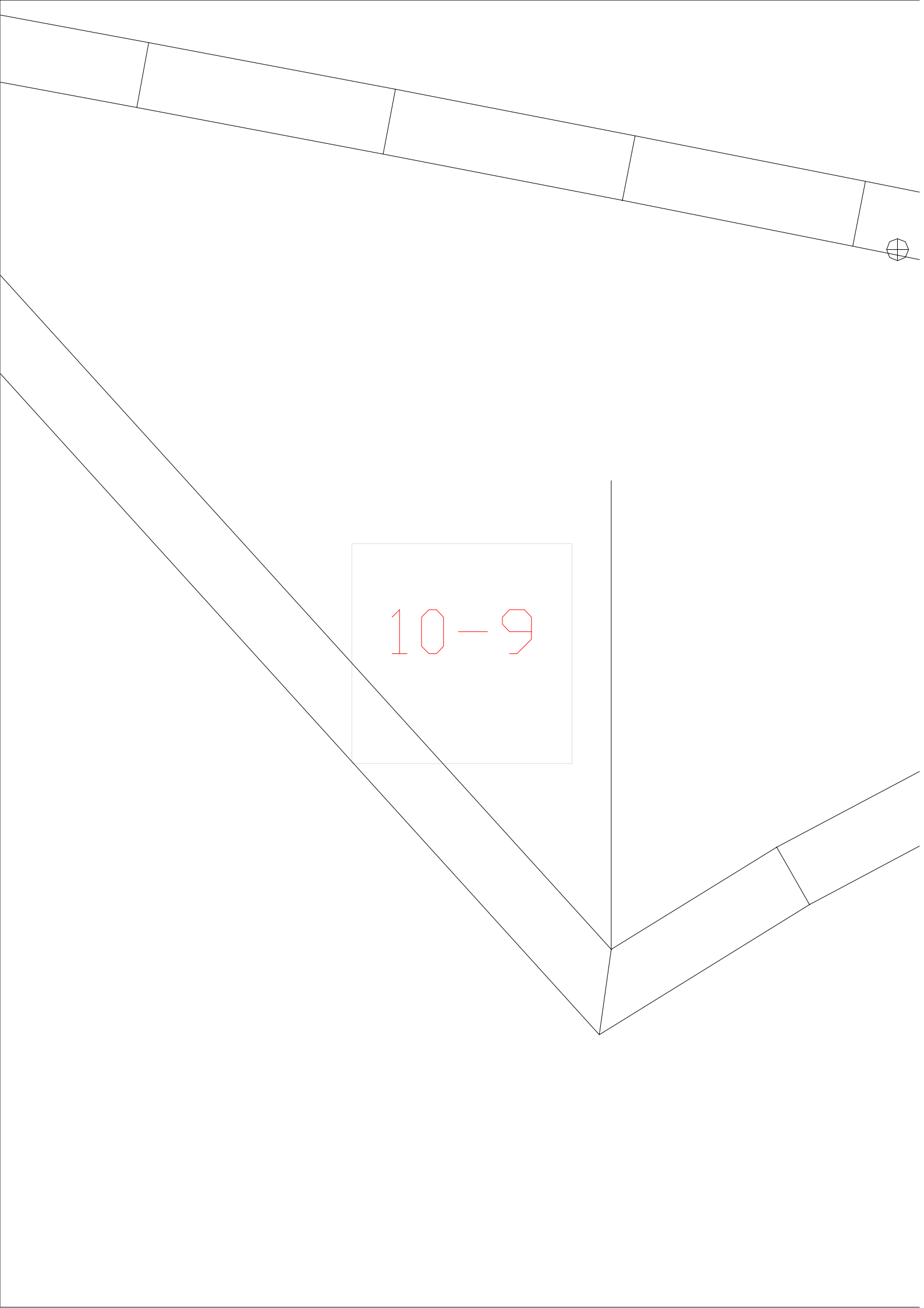

10-9

1-10

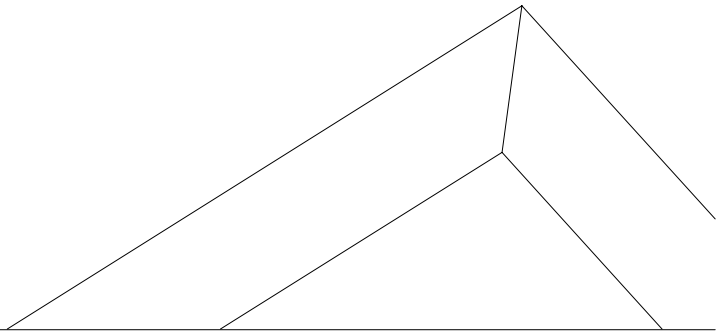

11-10

11 - 11

11-12

11-13

11-14

11-15

11-16

11-17

11-18

11-19

1-11

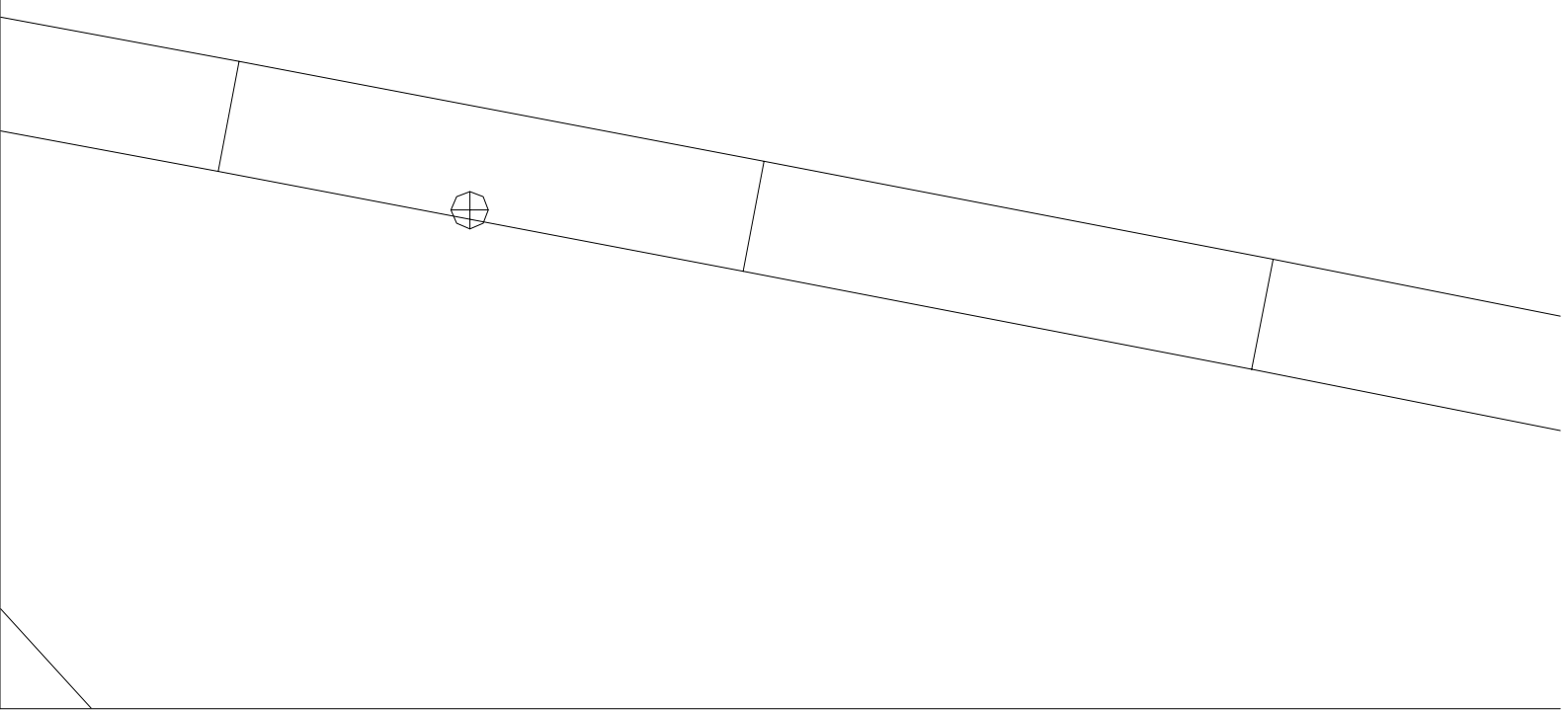

11-20

1-12



11-2

1-13

11-3

$$11 - 4$$

1-15

$$11 - 5$$

1-16

11-6

$$11 - 7$$

1-18

$$11 - 8$$

1-19

11-9

1-1

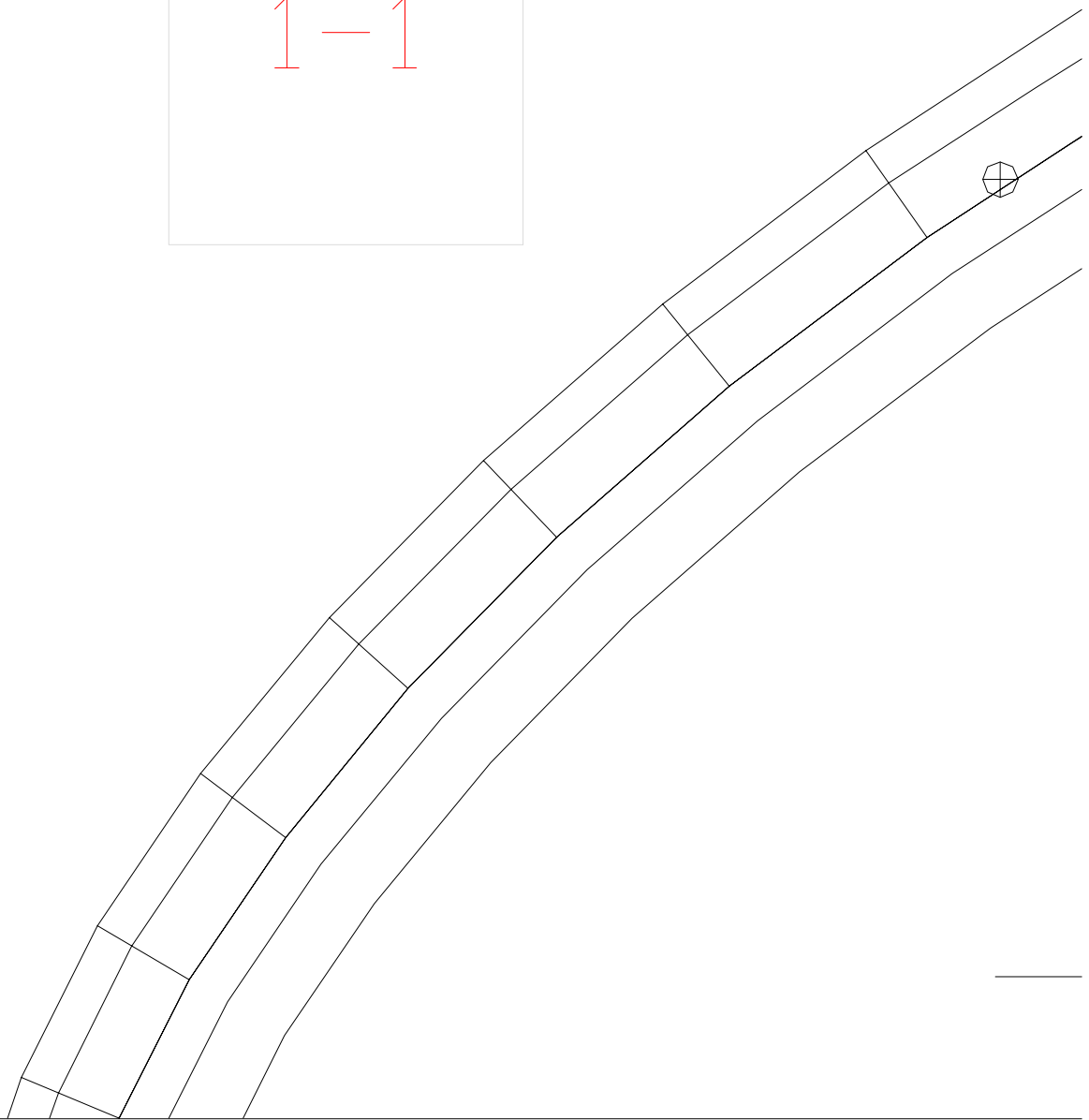

1-20

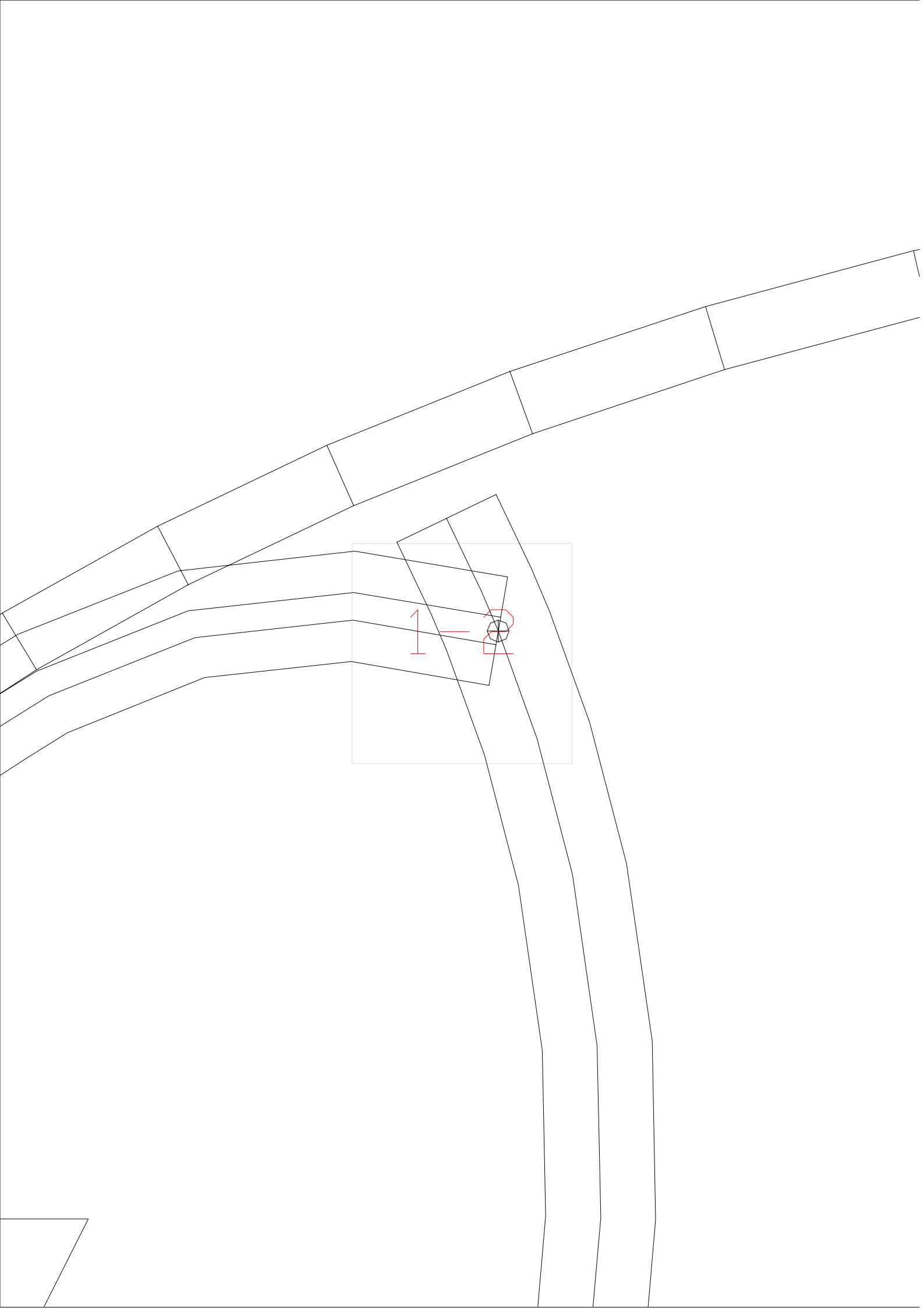

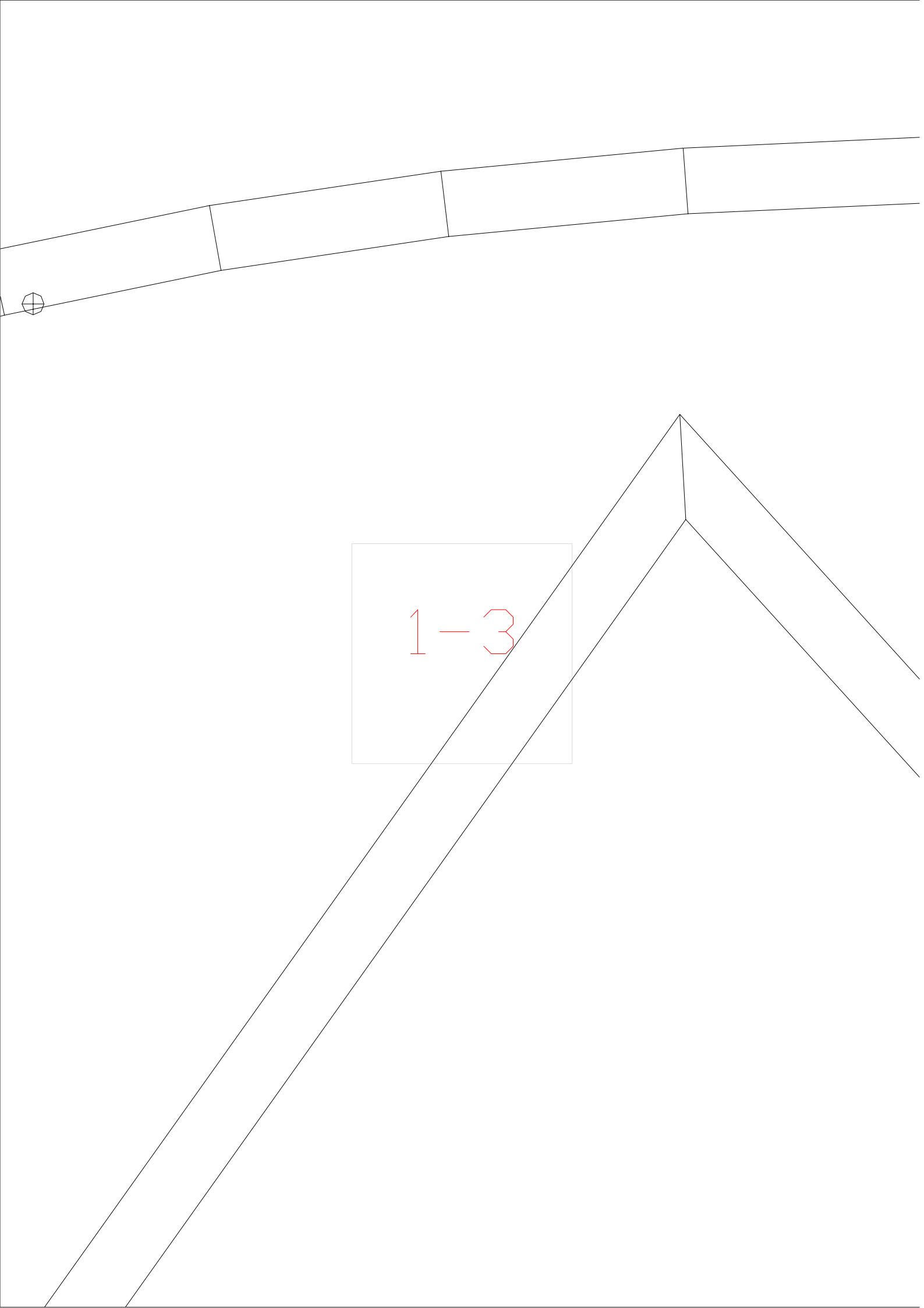

1-3

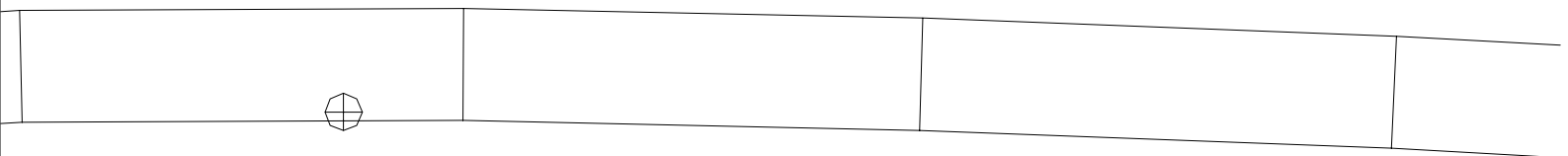

1-4

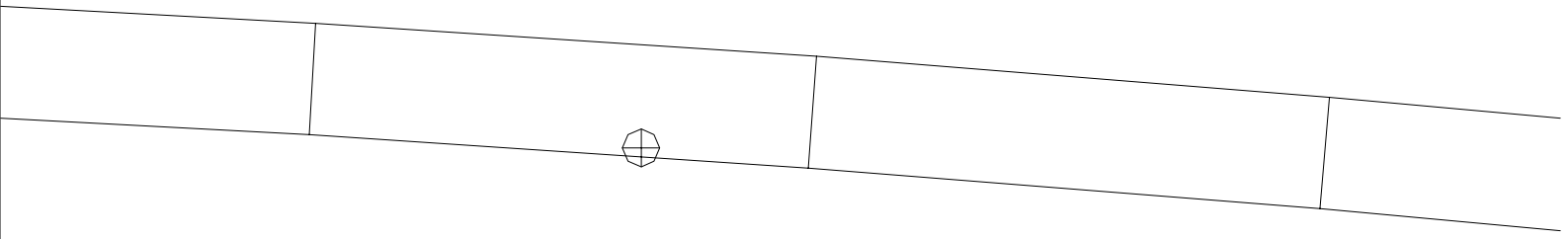

1-5

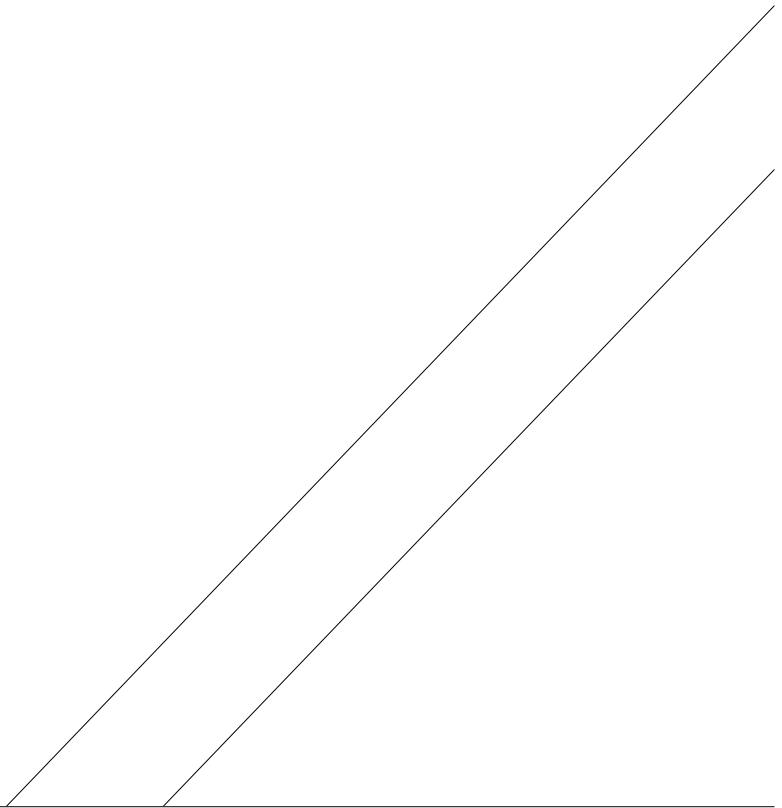

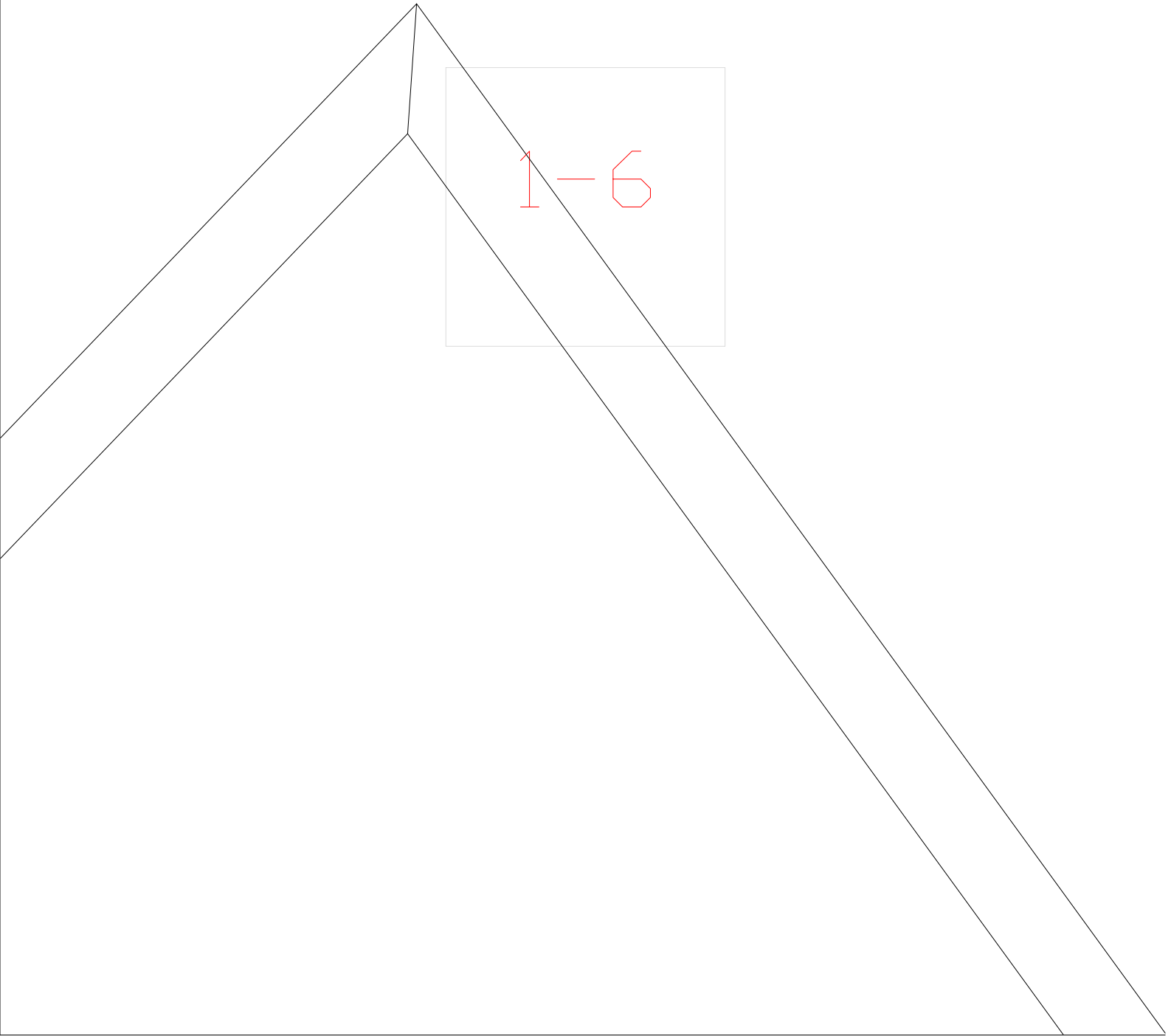
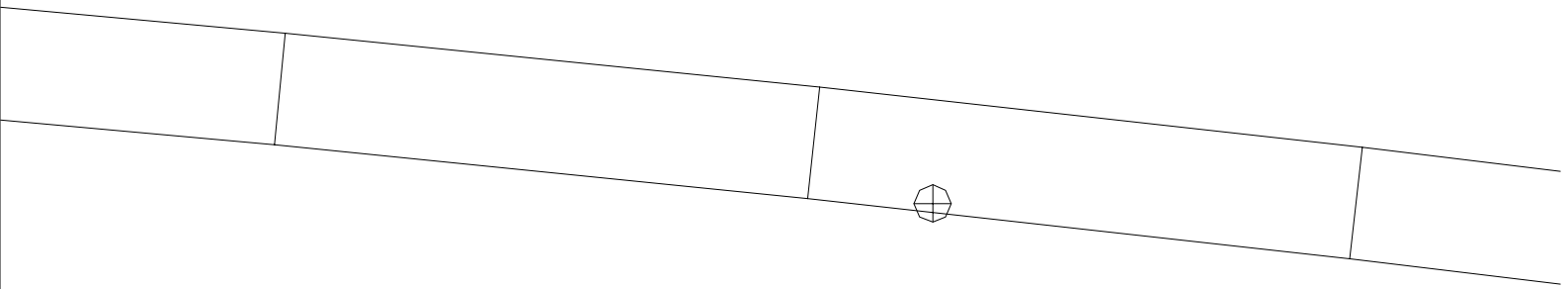

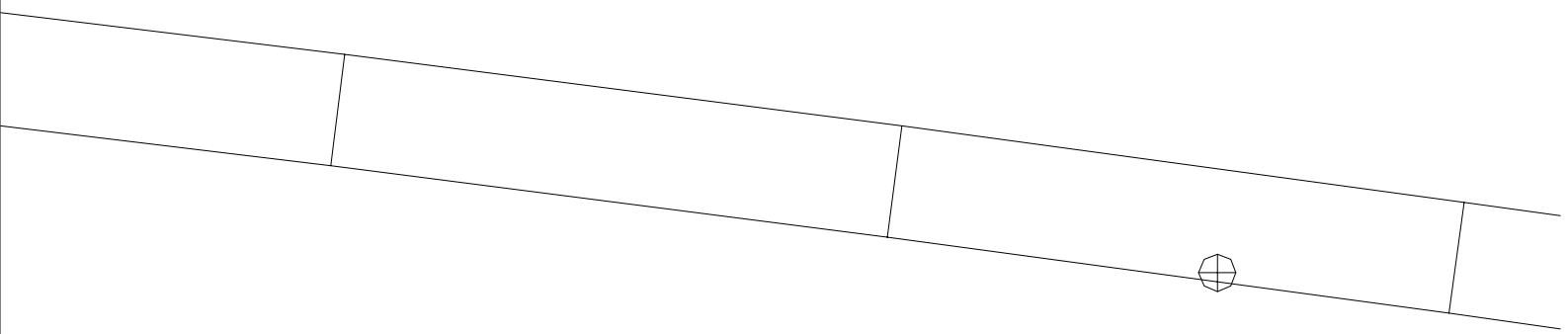

1-7

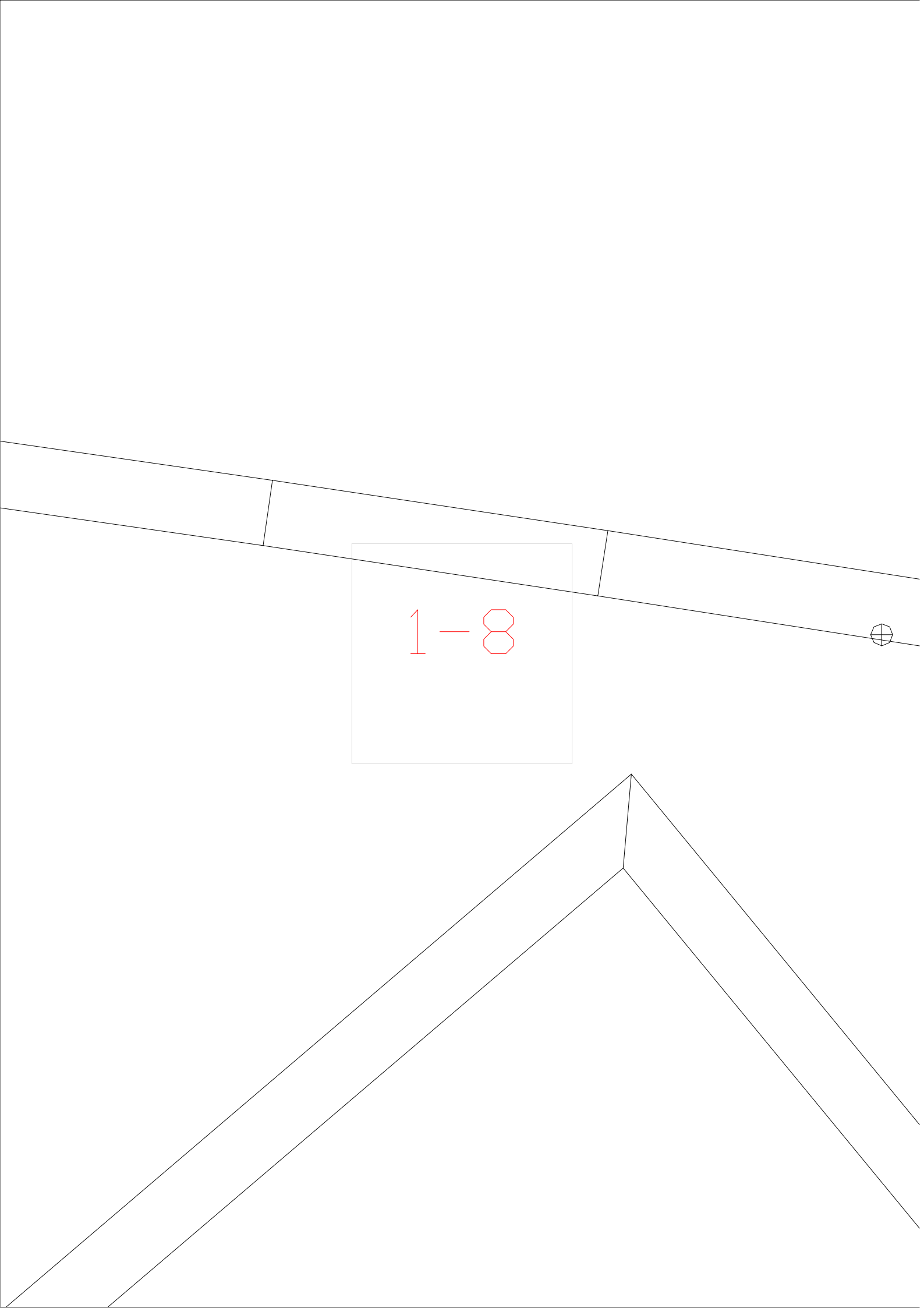

1-8



1-9

2-10



2-11

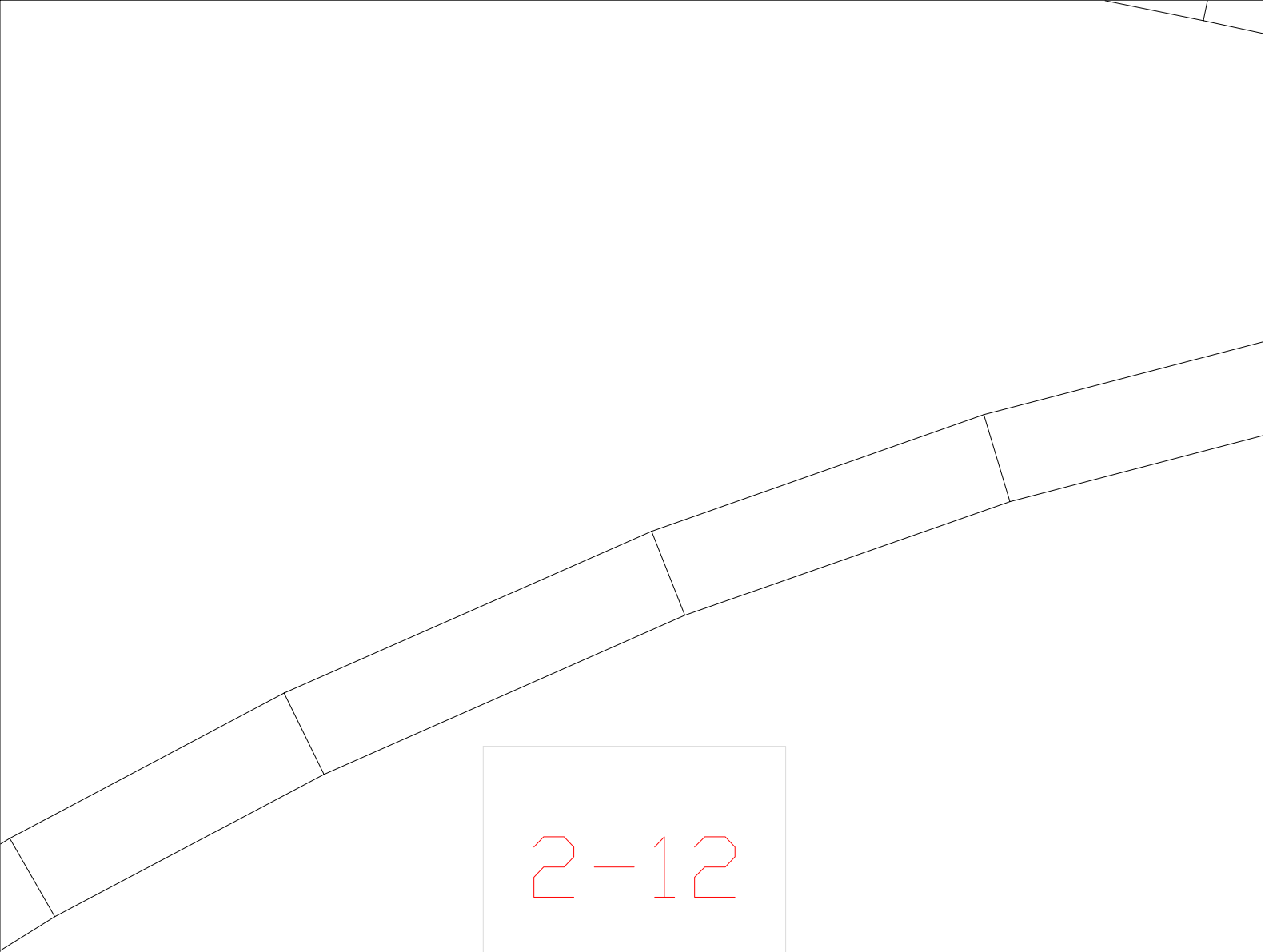

2-12

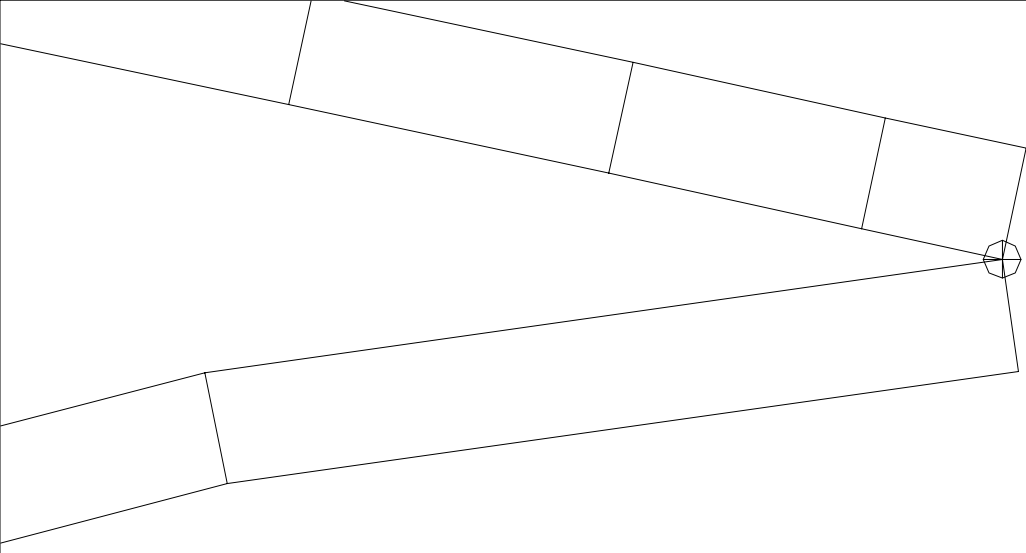

2-13

2-14

2-15

2-16

2-17

2-18

2-19

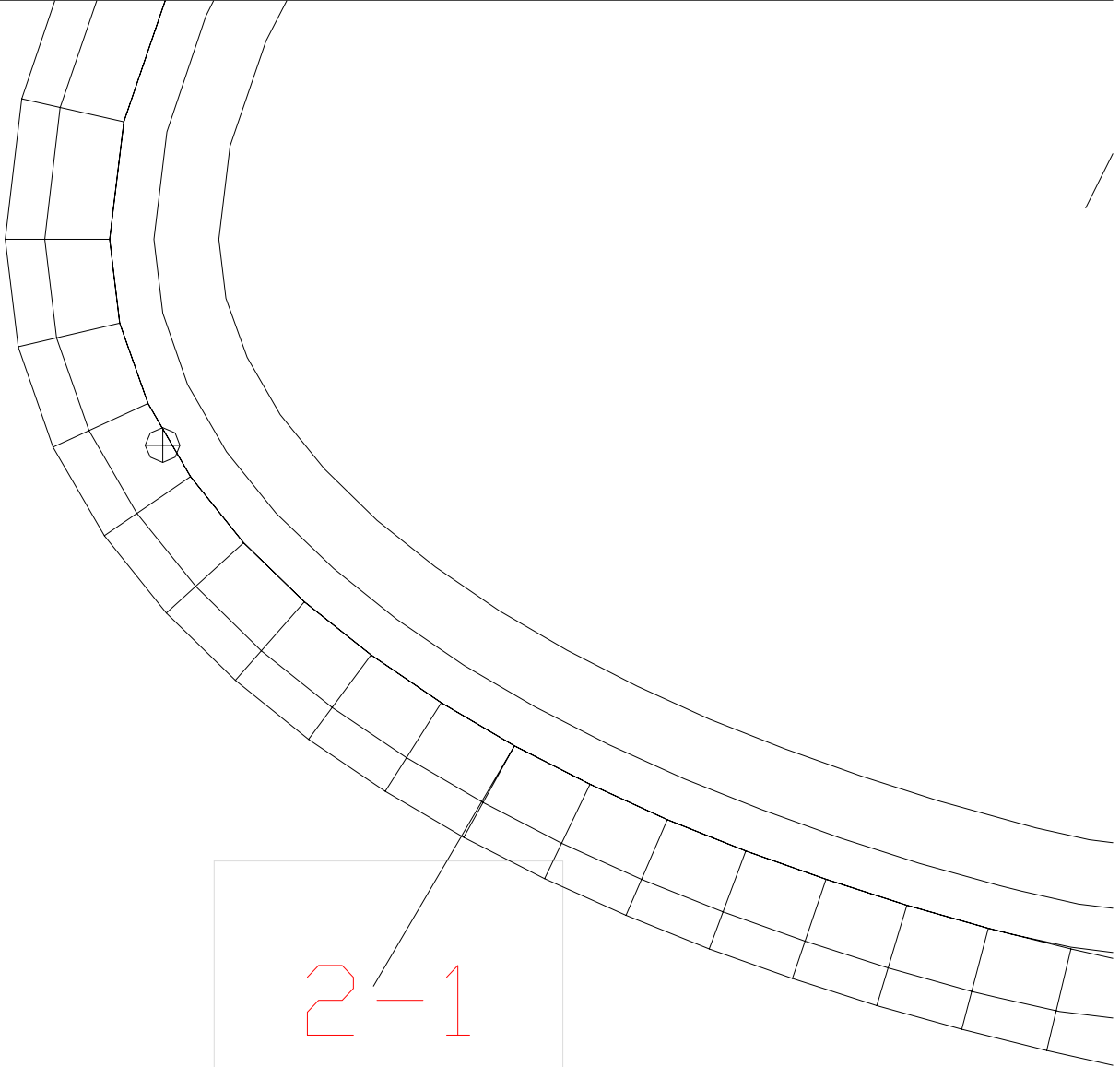

2-1

2-20

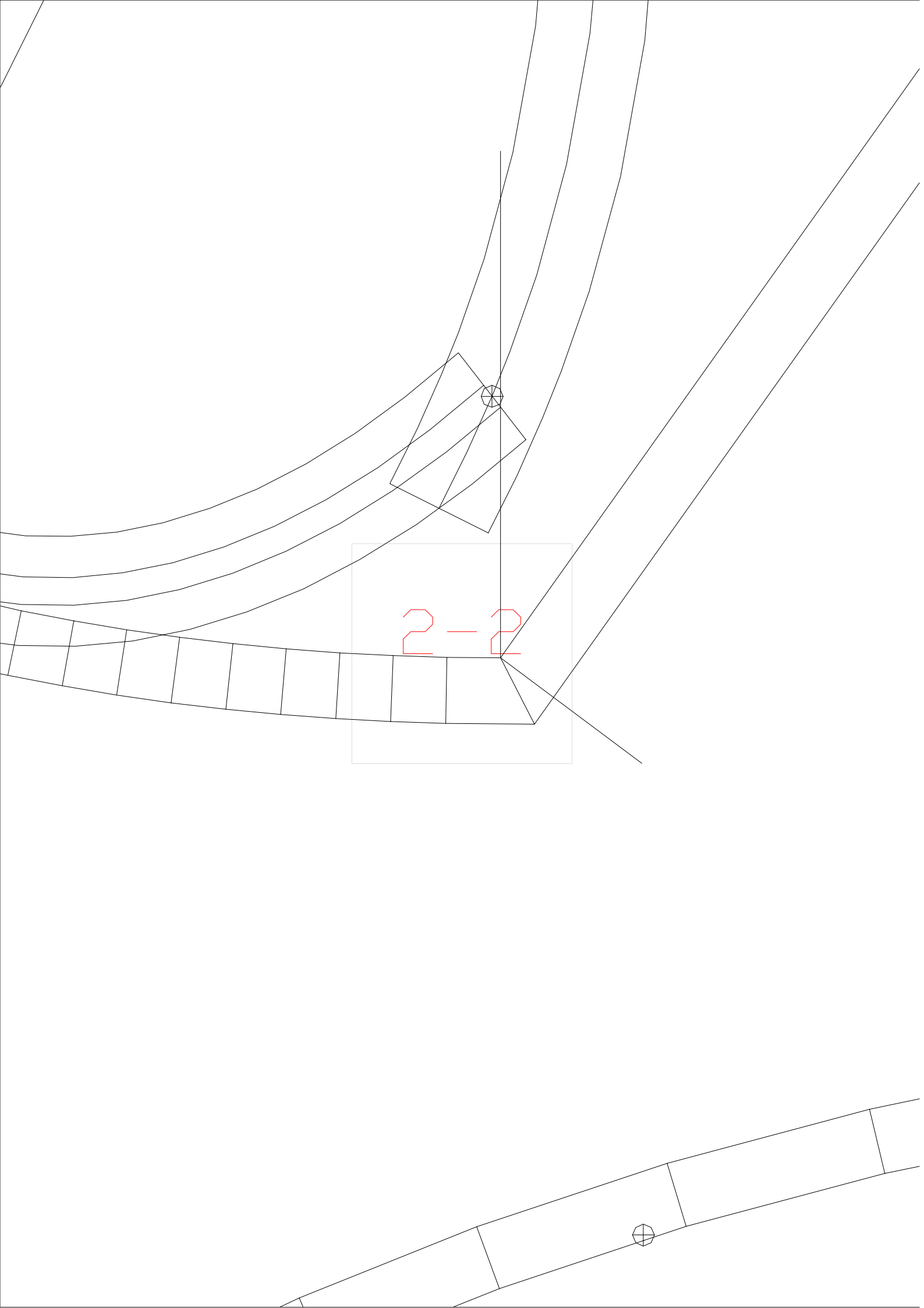

2-3

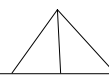

2-4

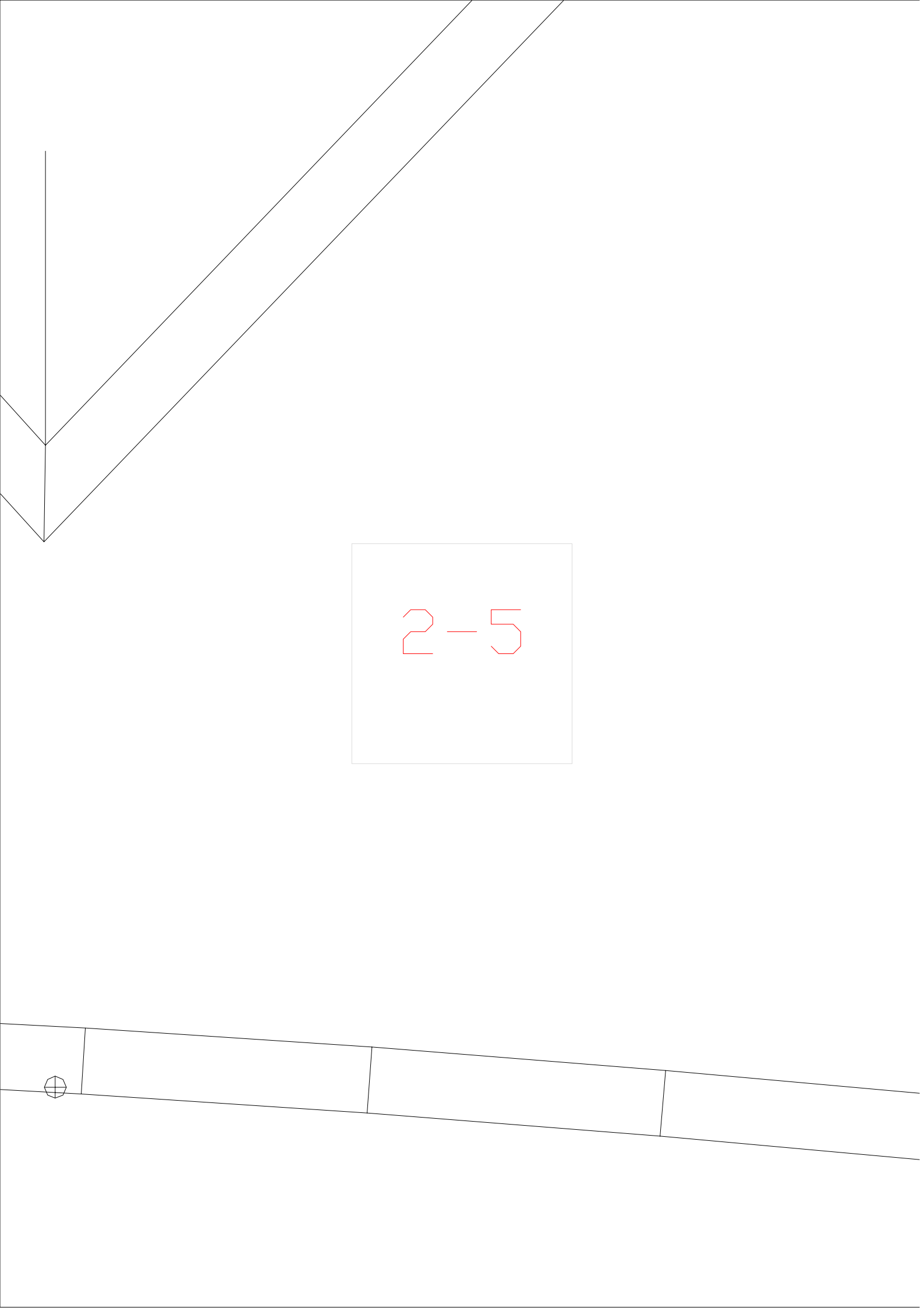

2-5

2-6





2-7

2-8



2-9

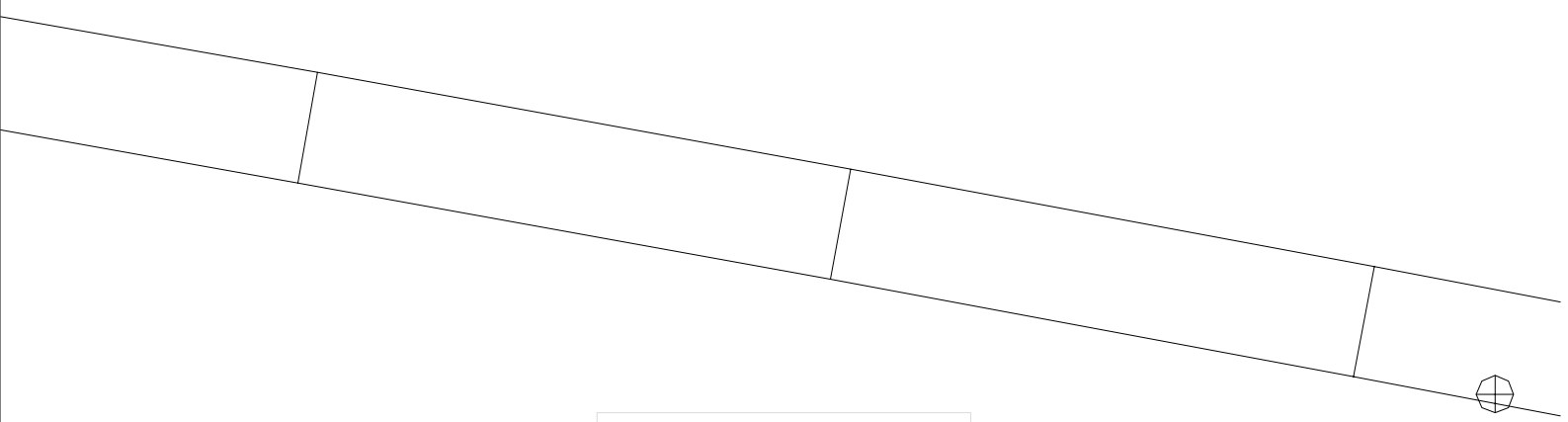

3-10

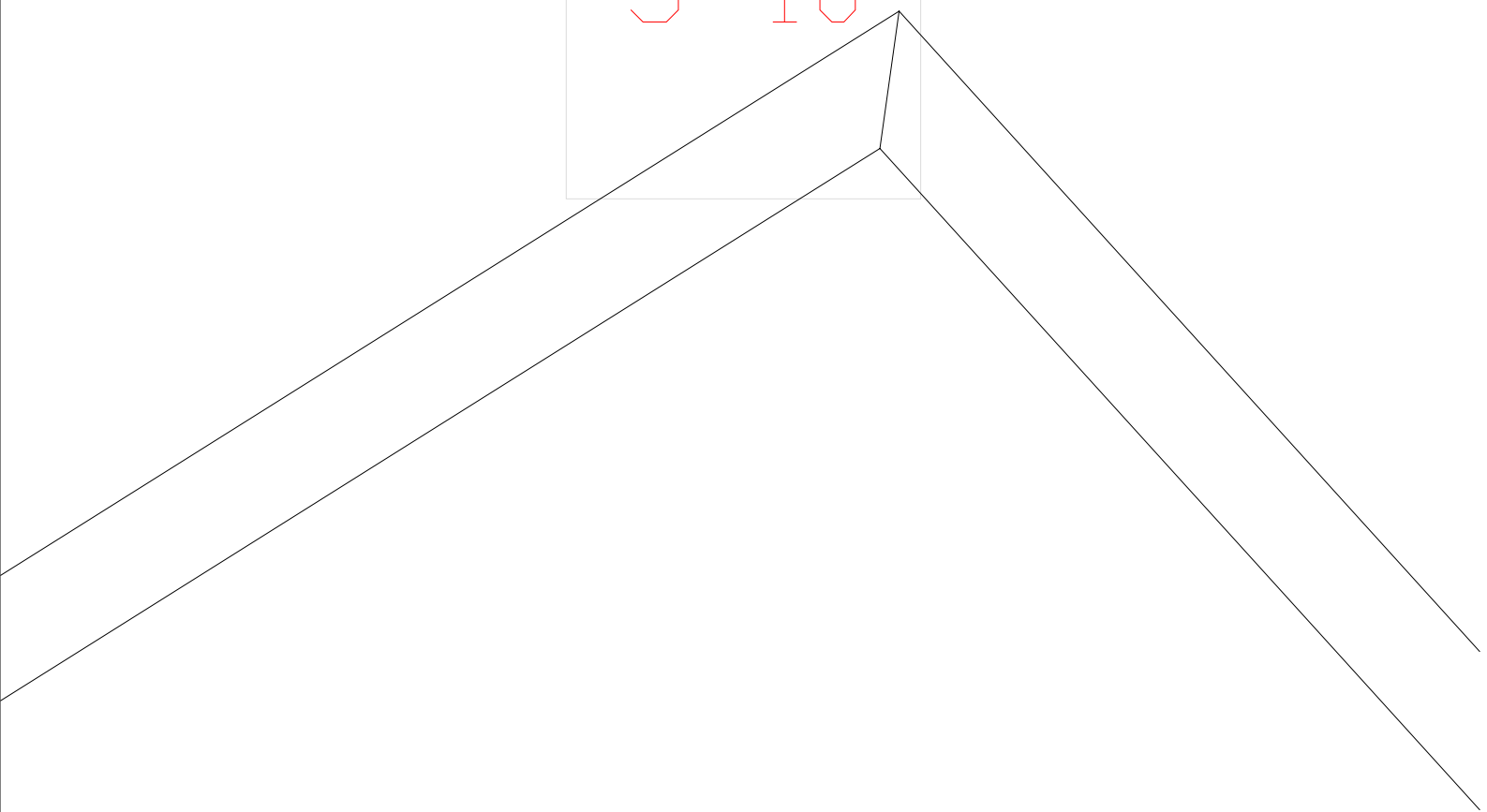

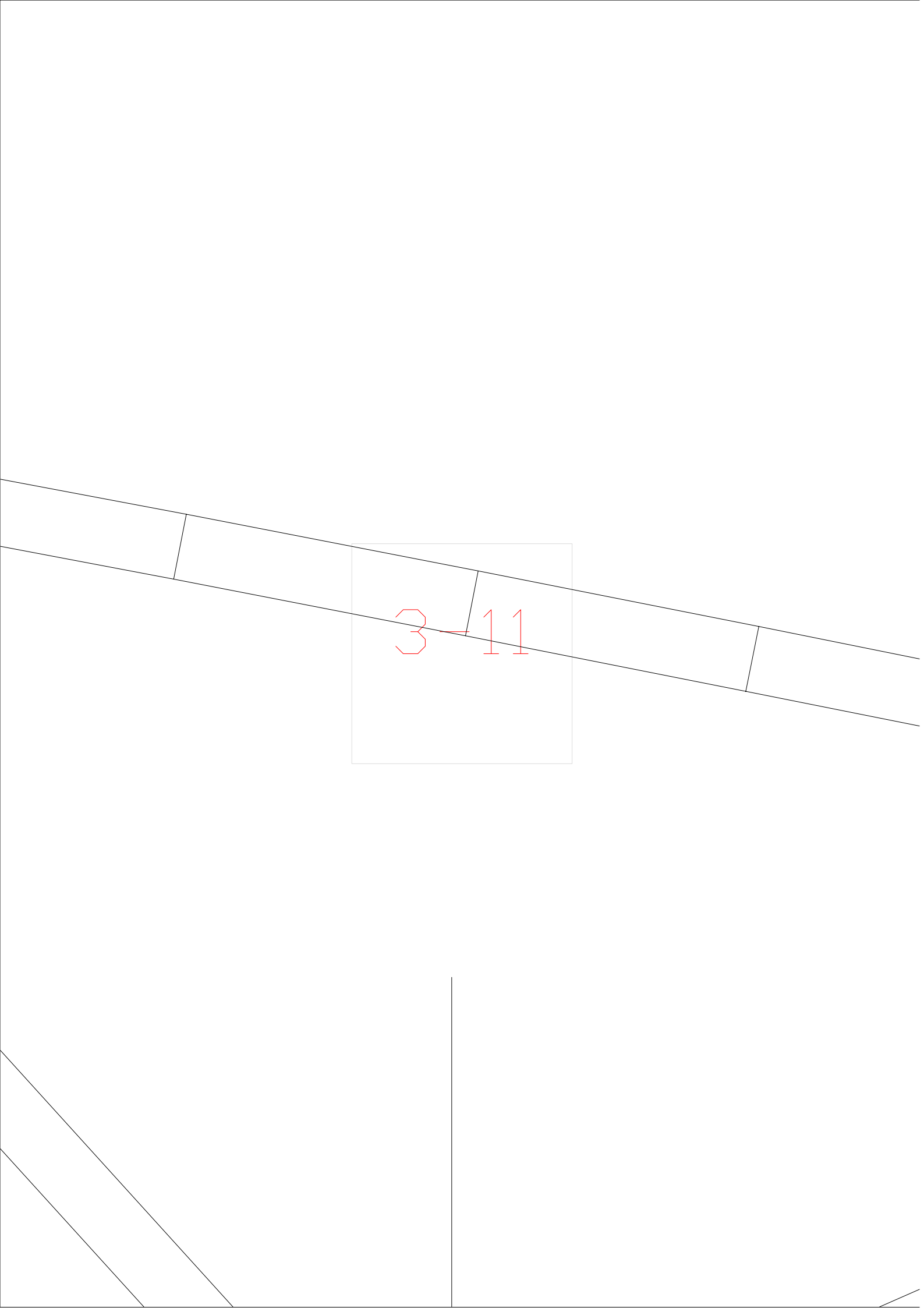

3-12



3-13

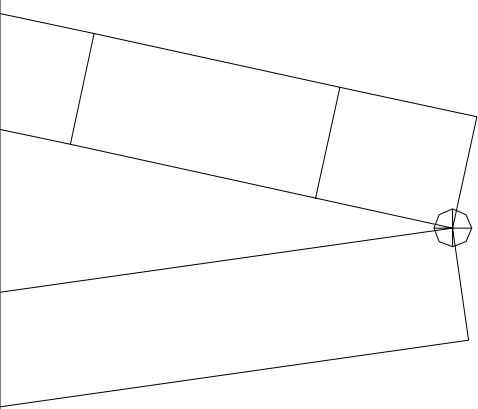

3-14

3-15

3-16

3-17

3-18

3-19

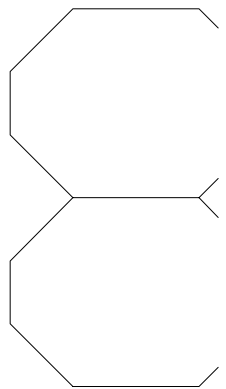
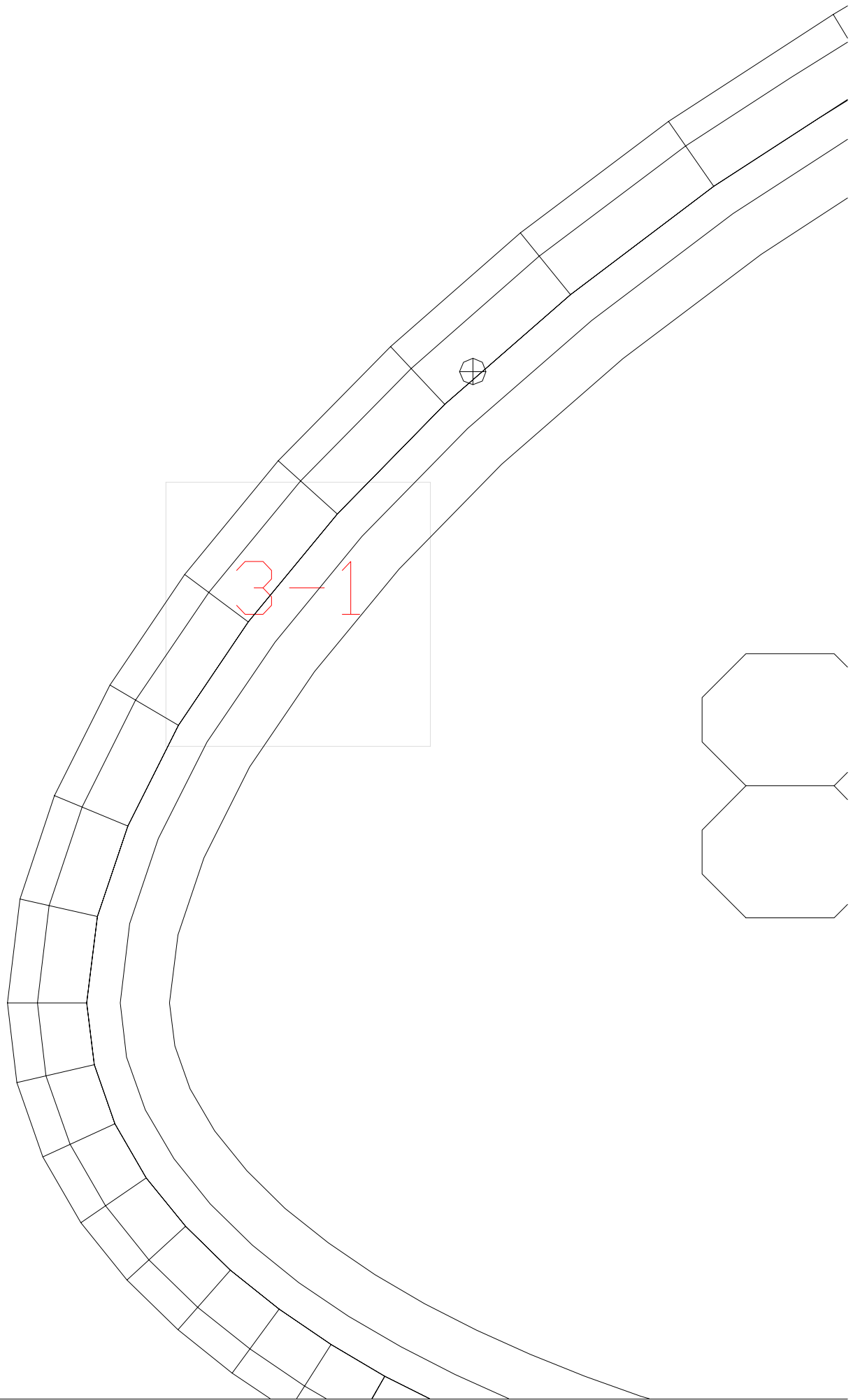

3-20

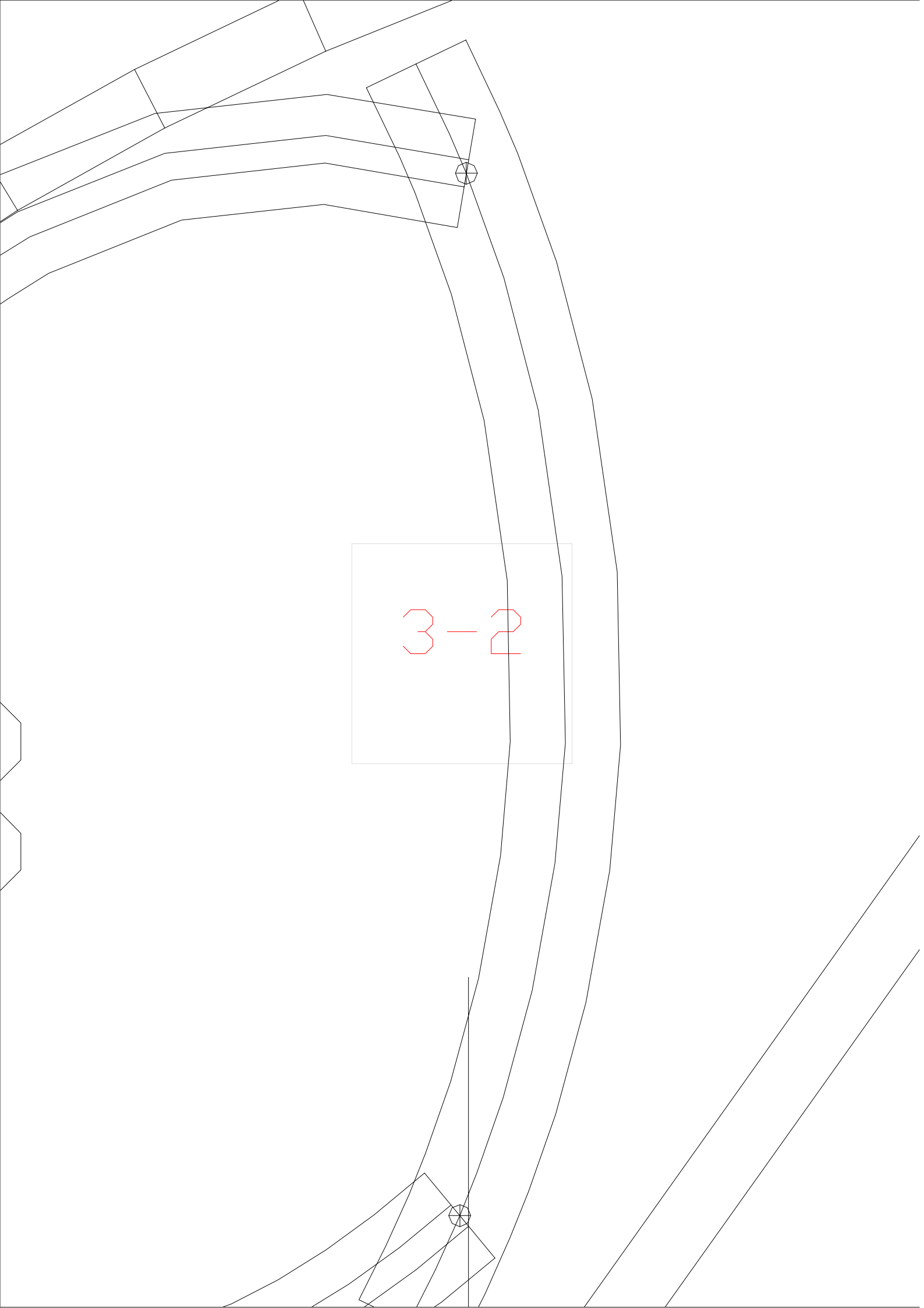

3-2

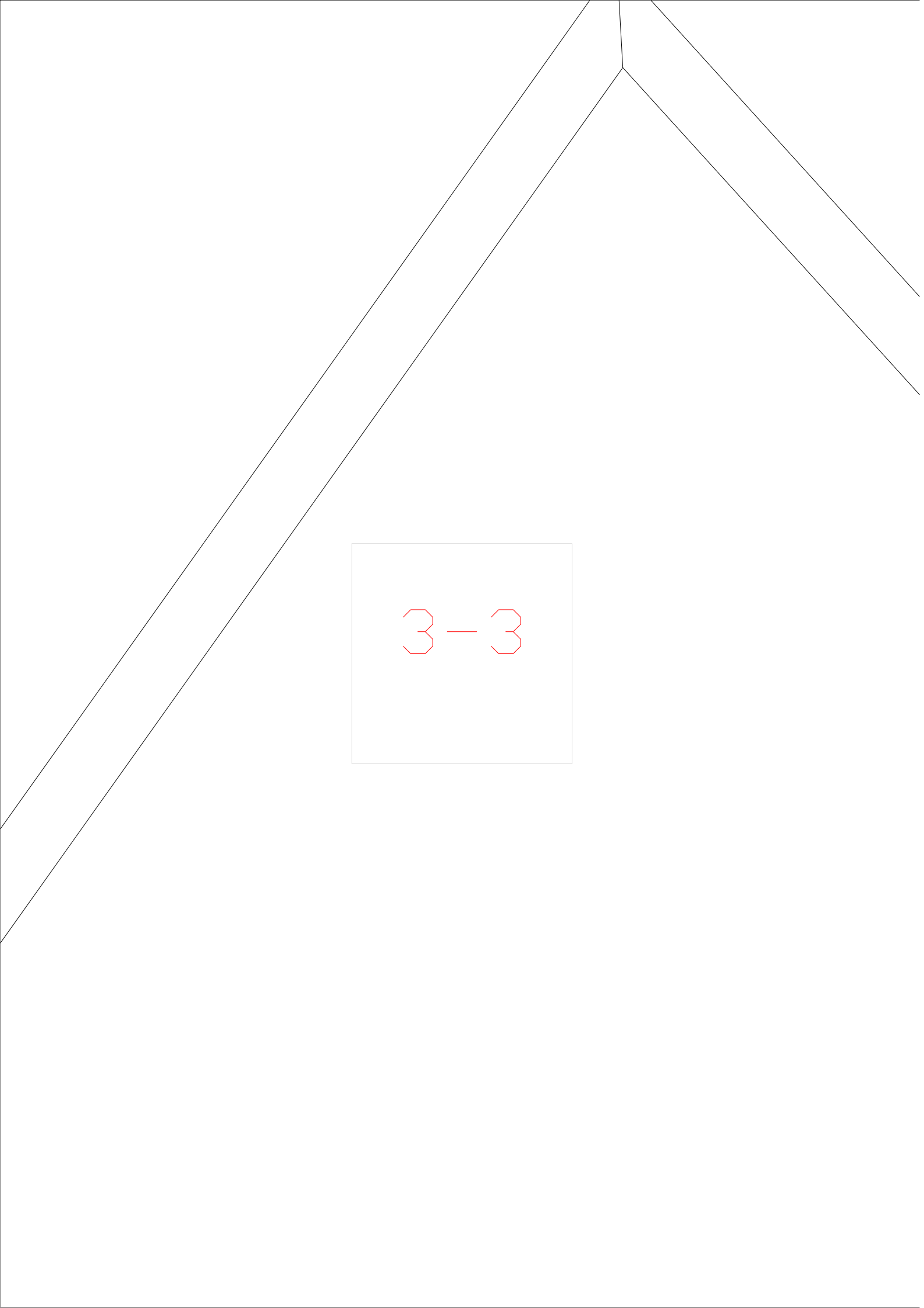

3-3

3-4



3-5

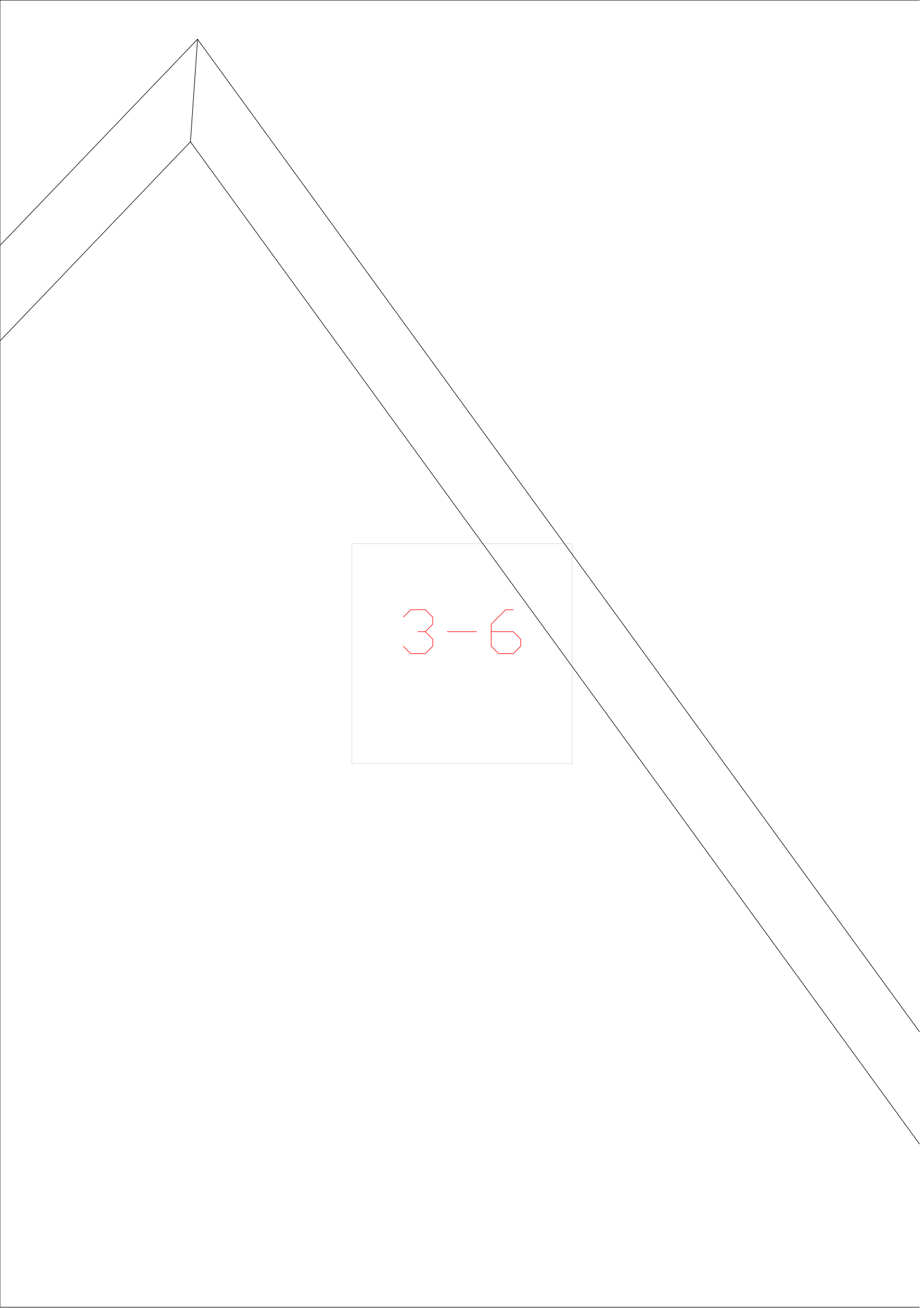

3-6

3-7

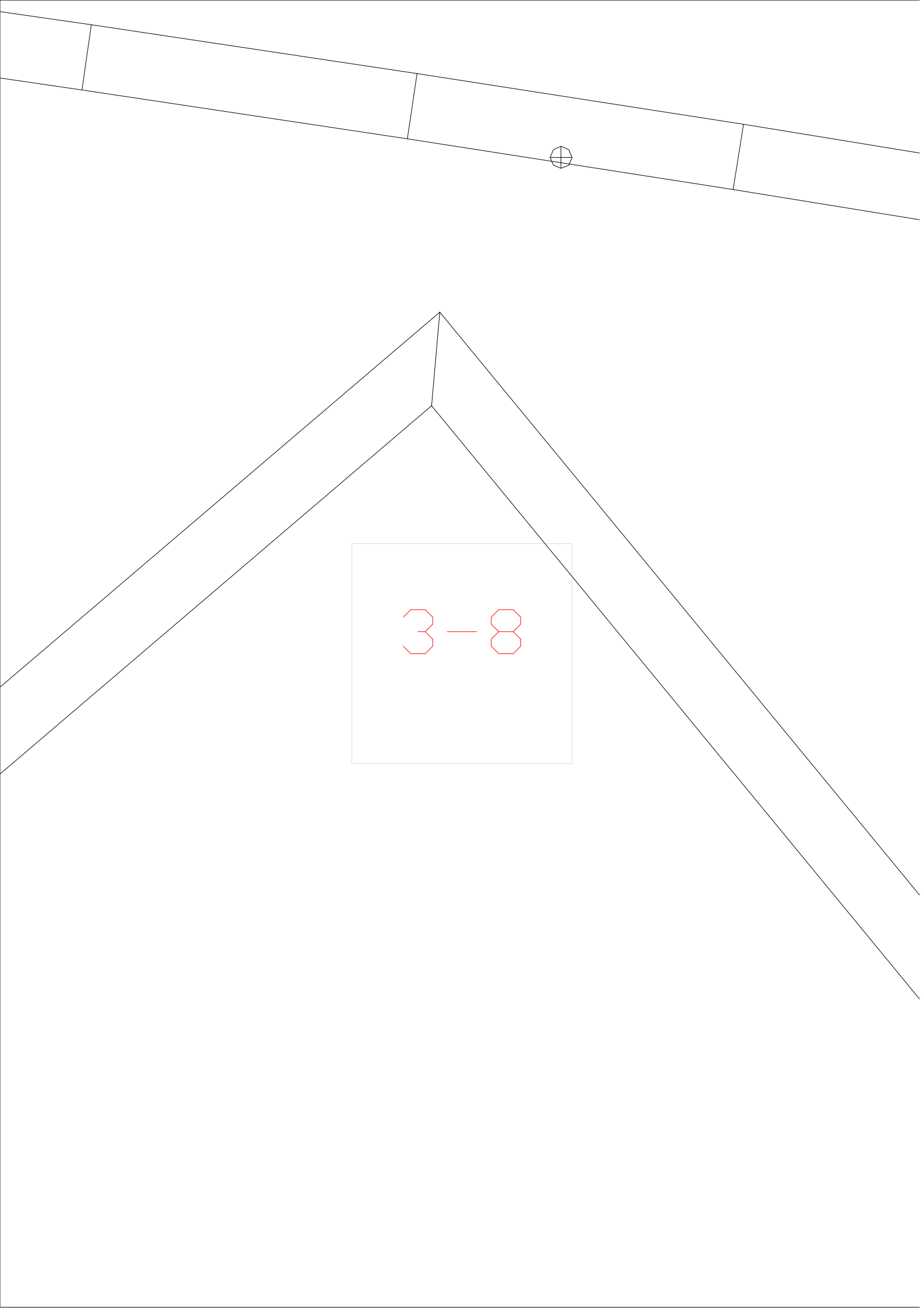

3-8

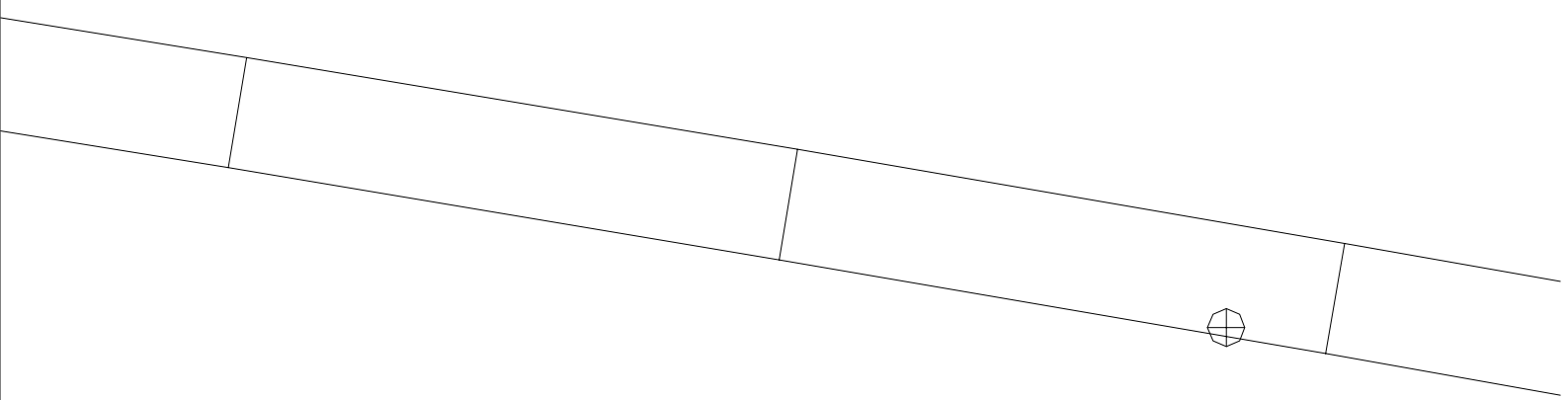

3-9

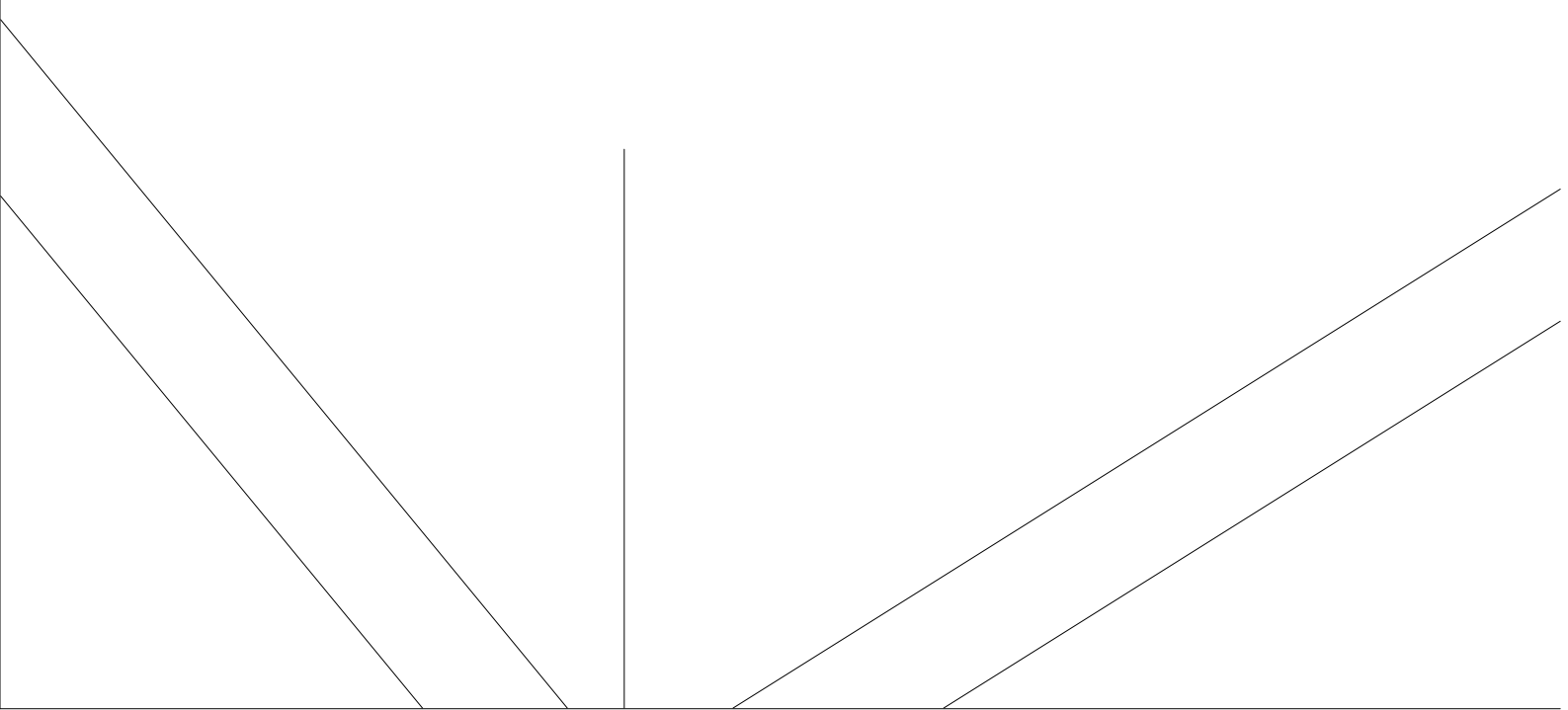

4-10

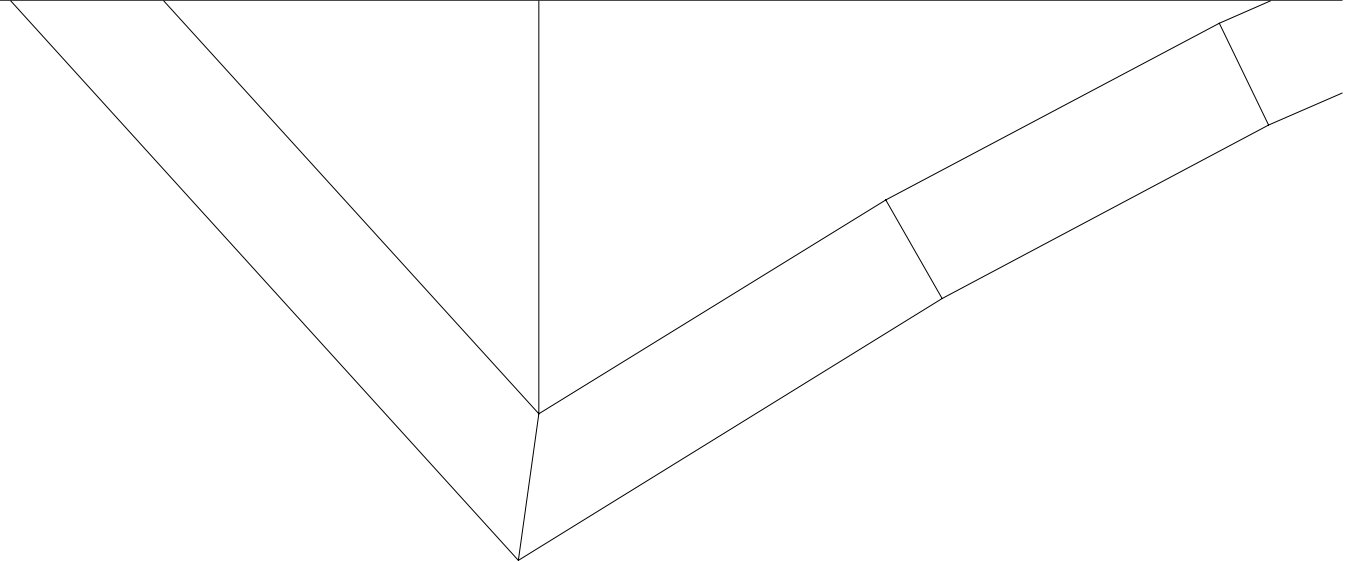

4-11

4-12

4-13

1

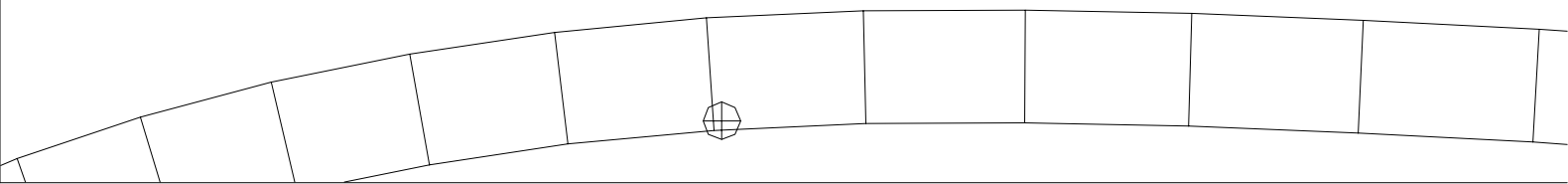
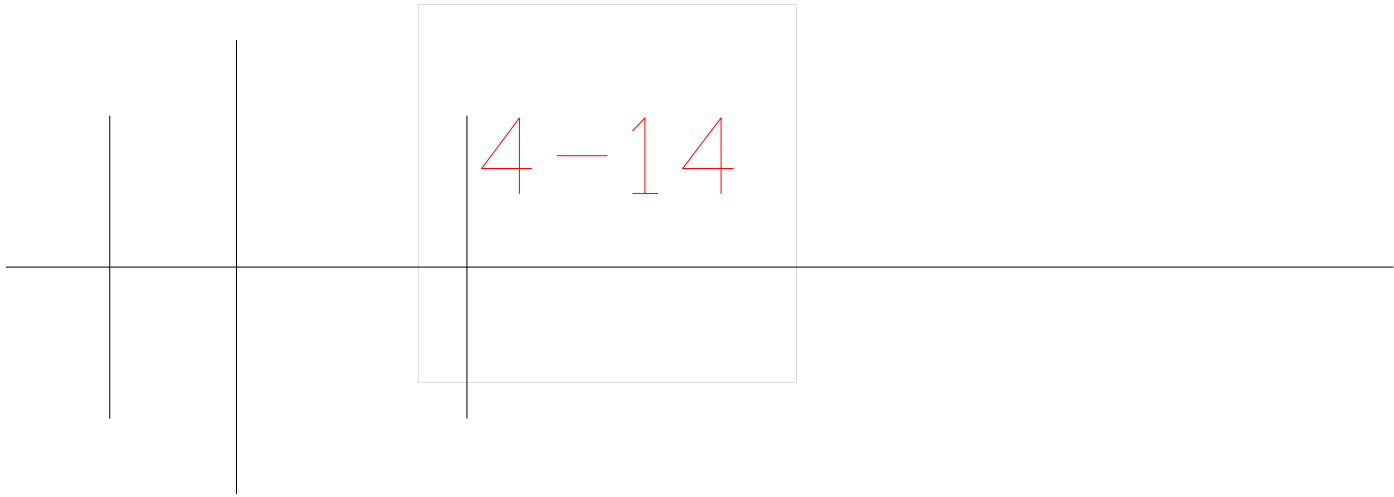
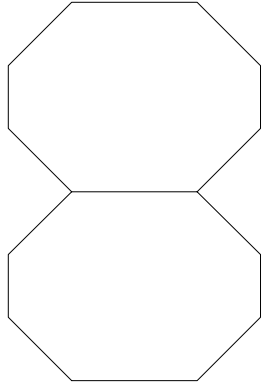

4-15

4-16

4-17

4-18

4-19

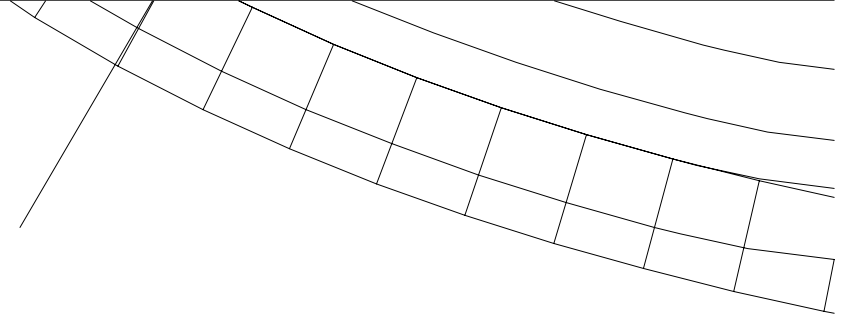
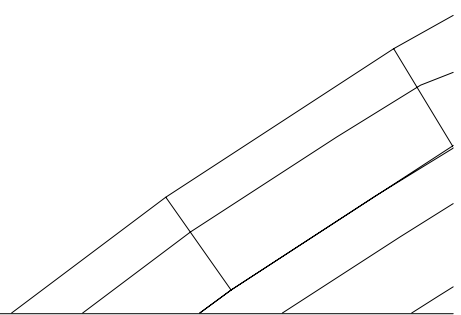

$$4 - 1$$

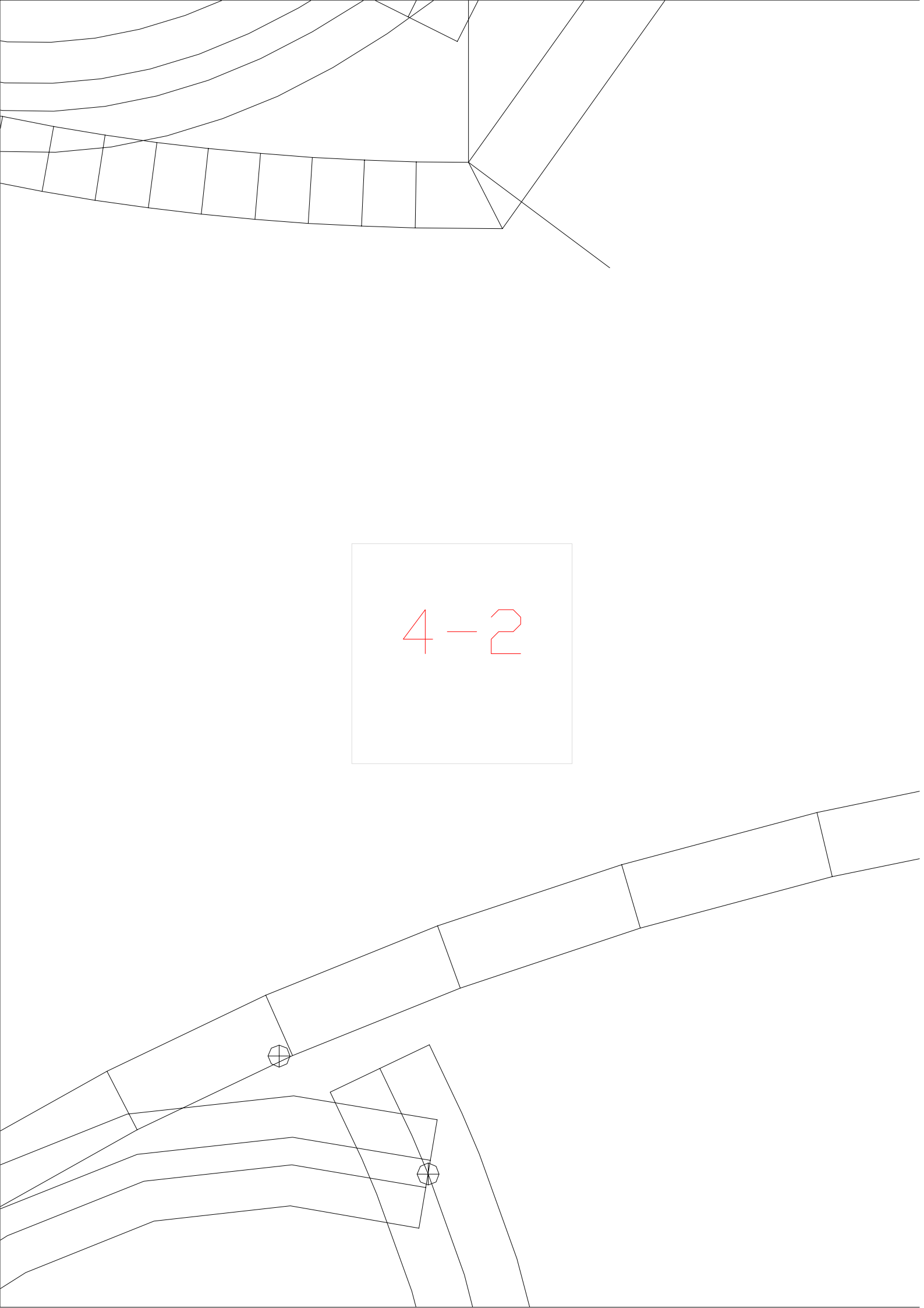
4-20

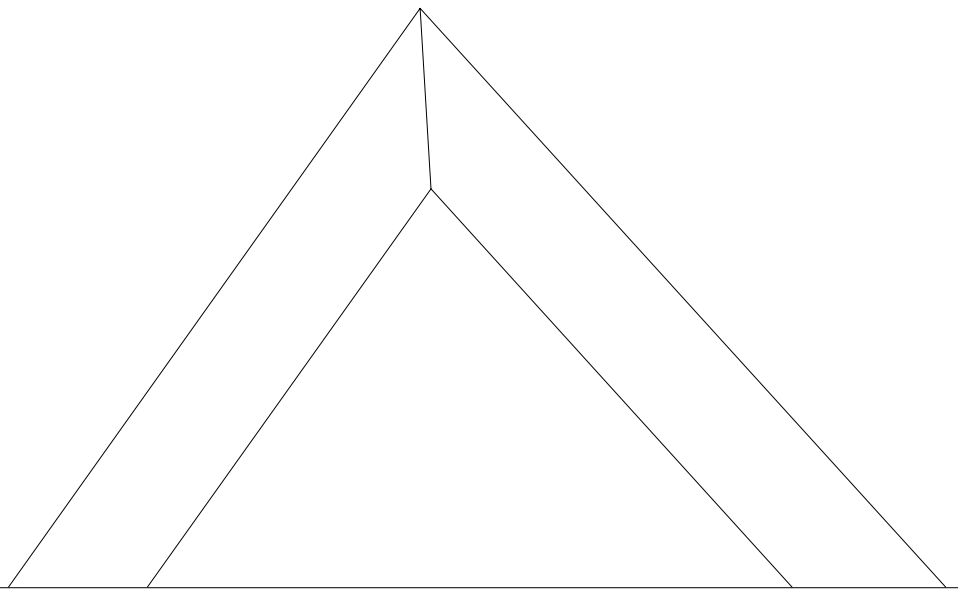

4-2

4-3



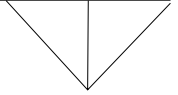

$$4 - 4$$



4-5



4-6

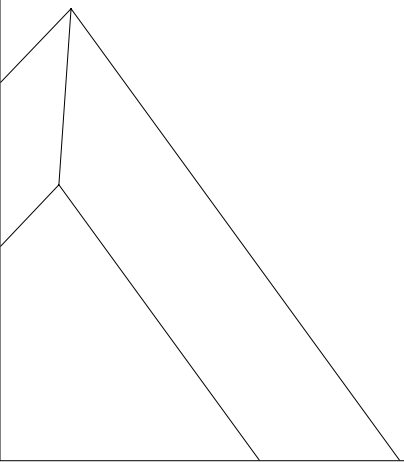
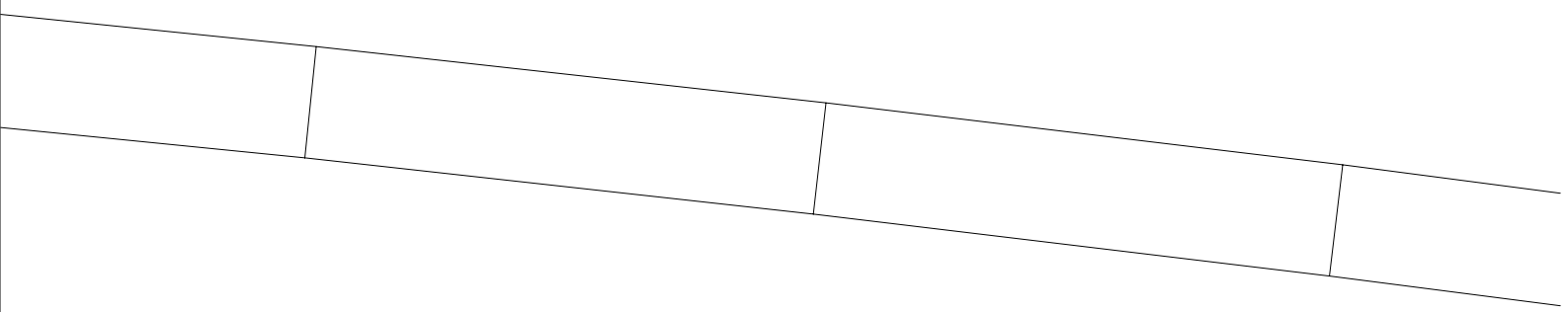

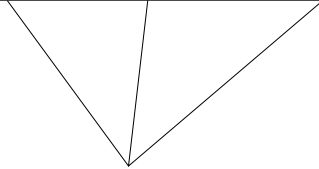

4-7

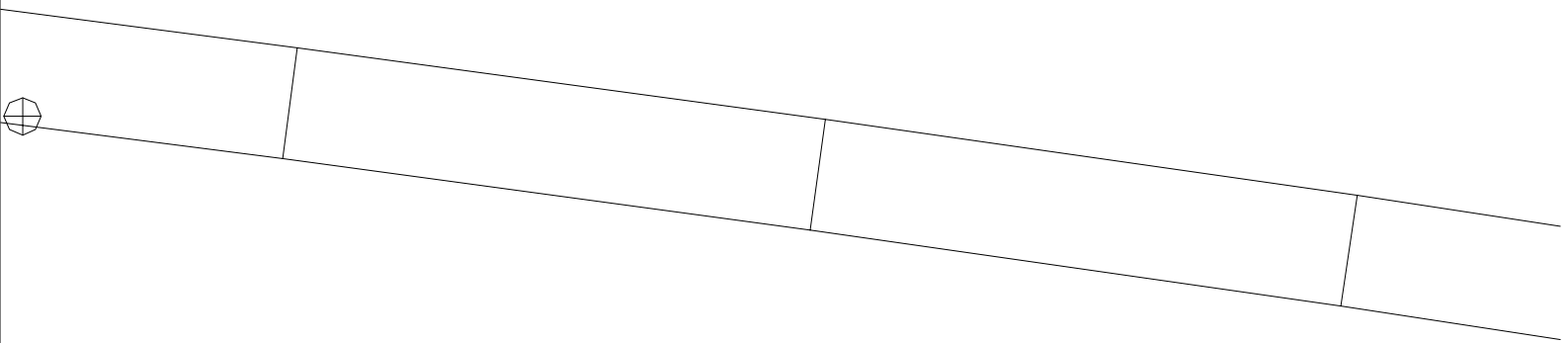

4-8





4-9

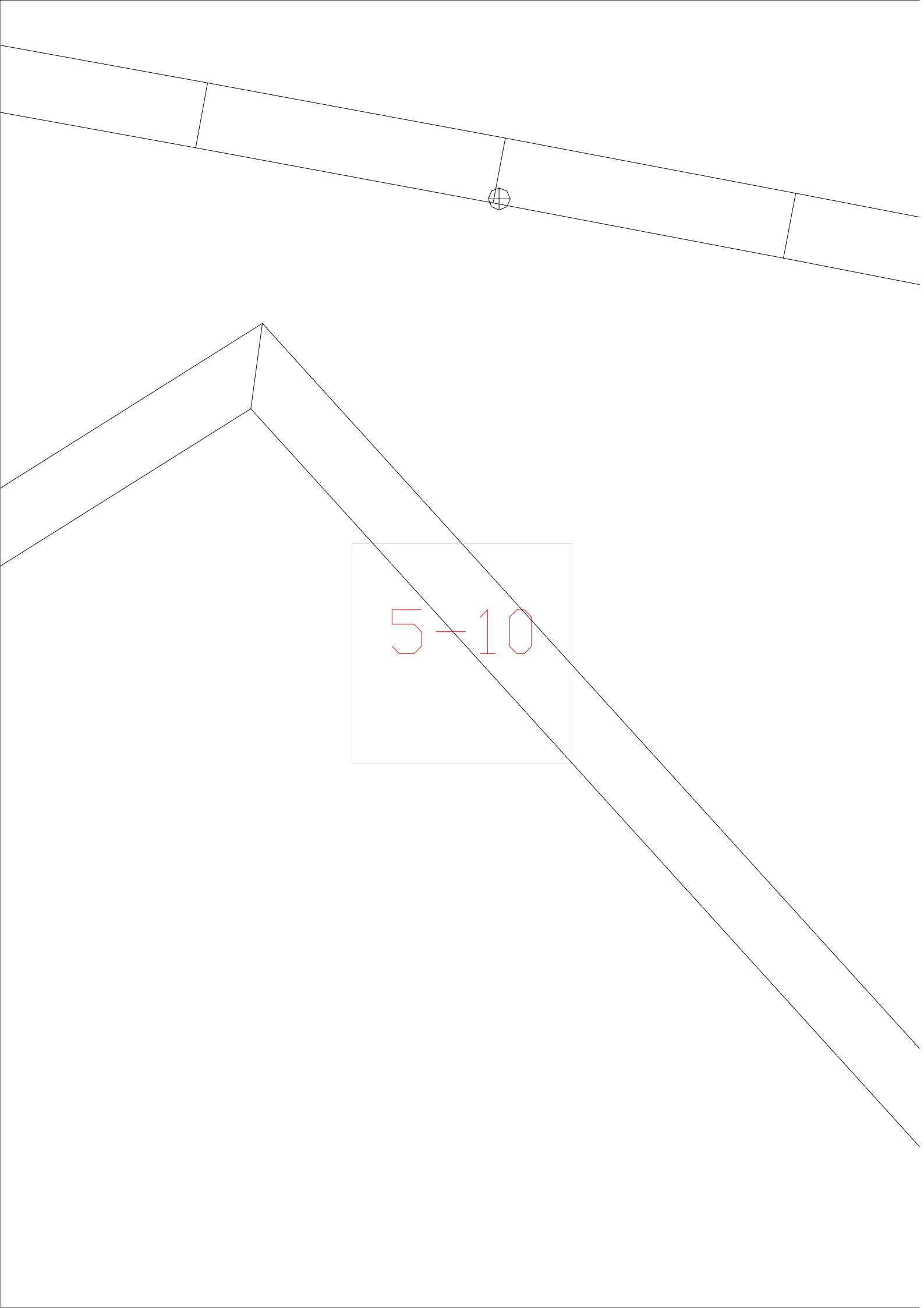

5-10

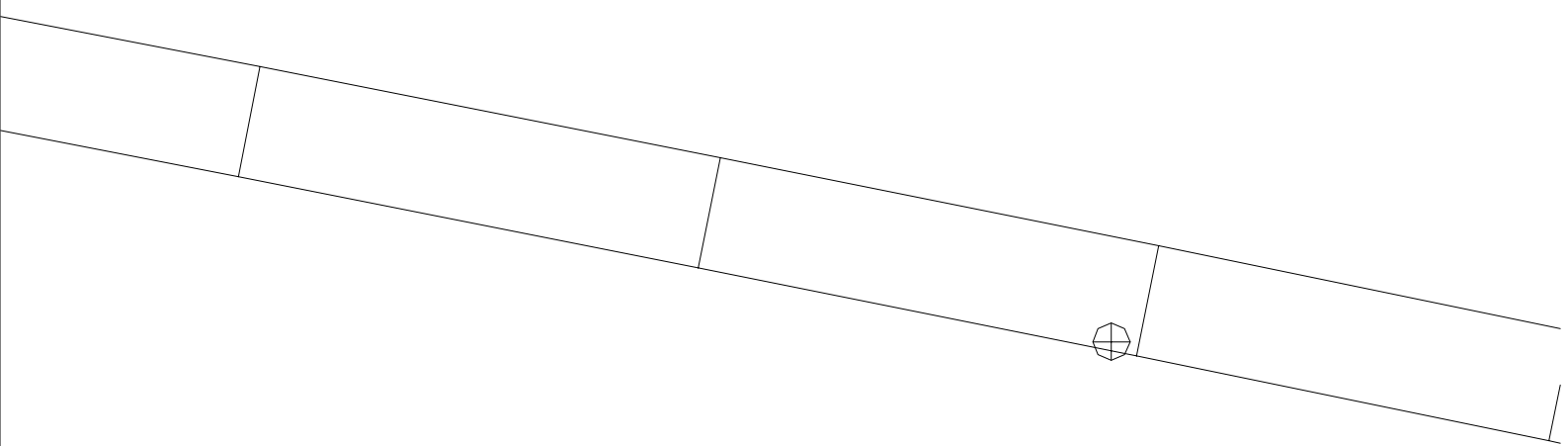

5-11

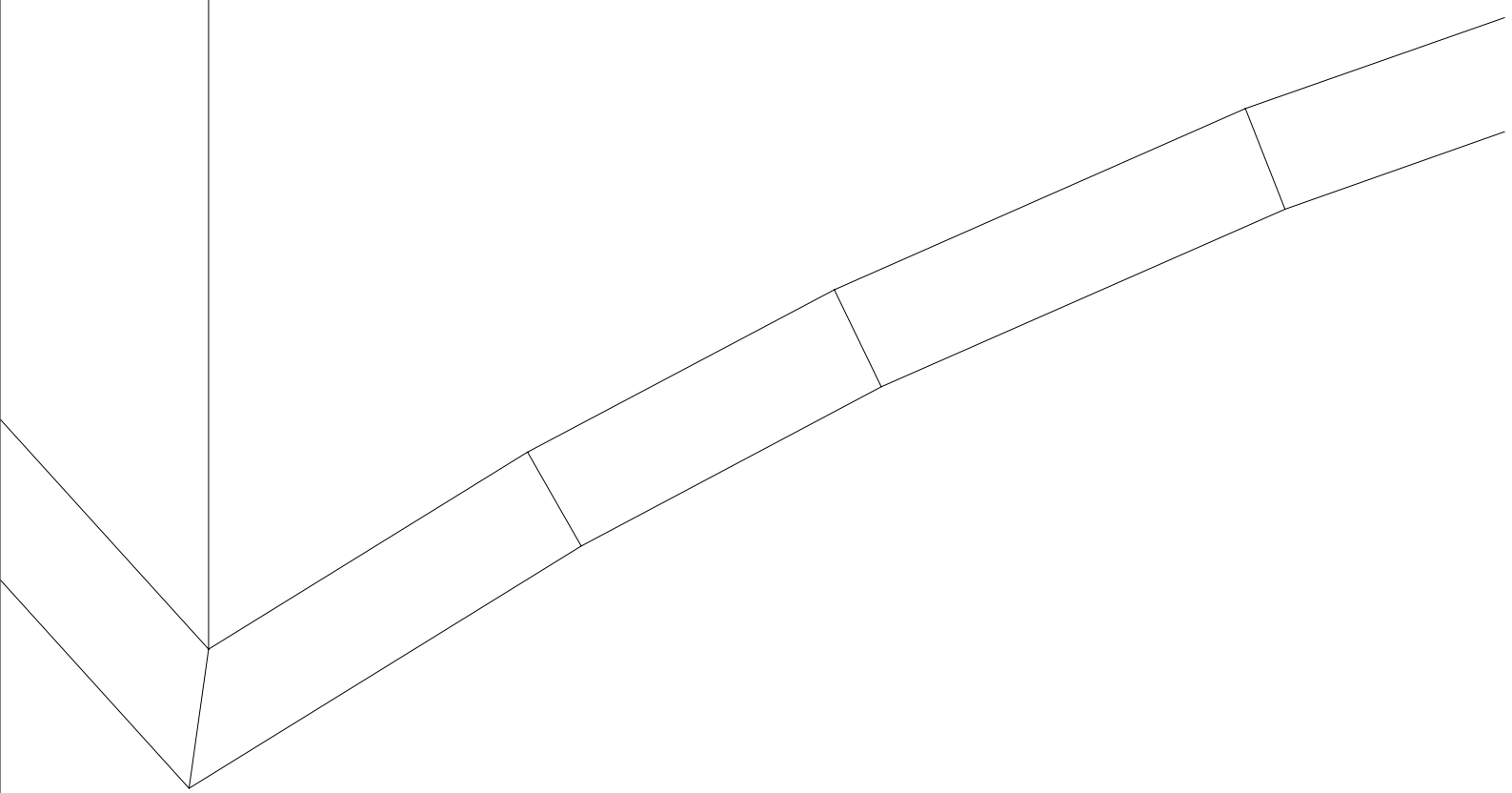

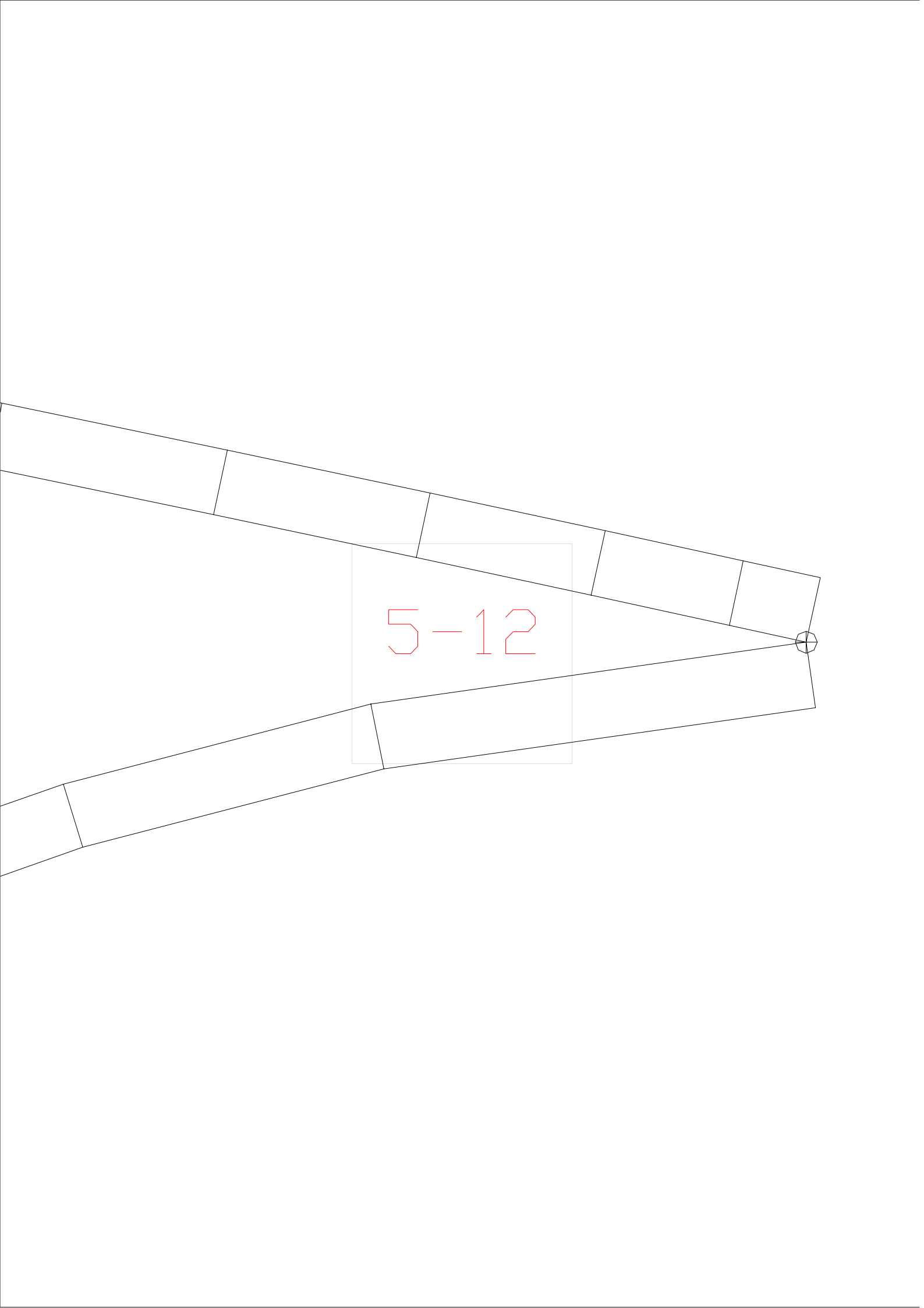

5-12

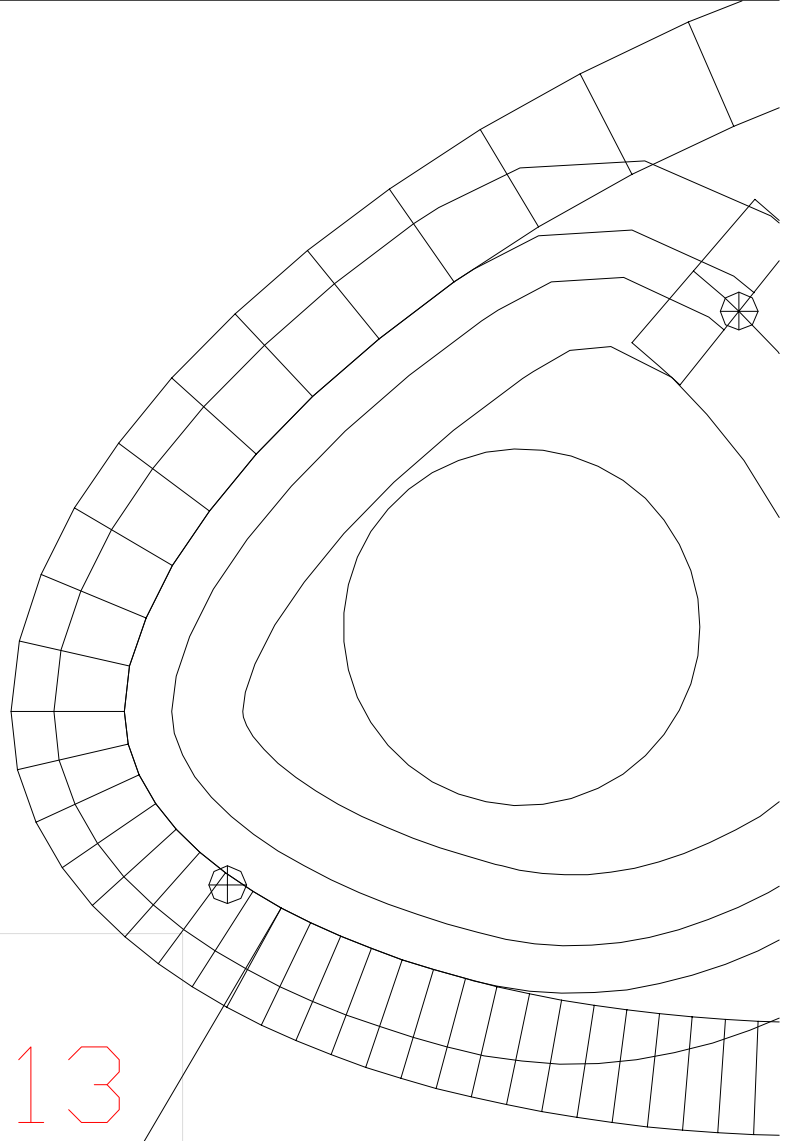

5-13

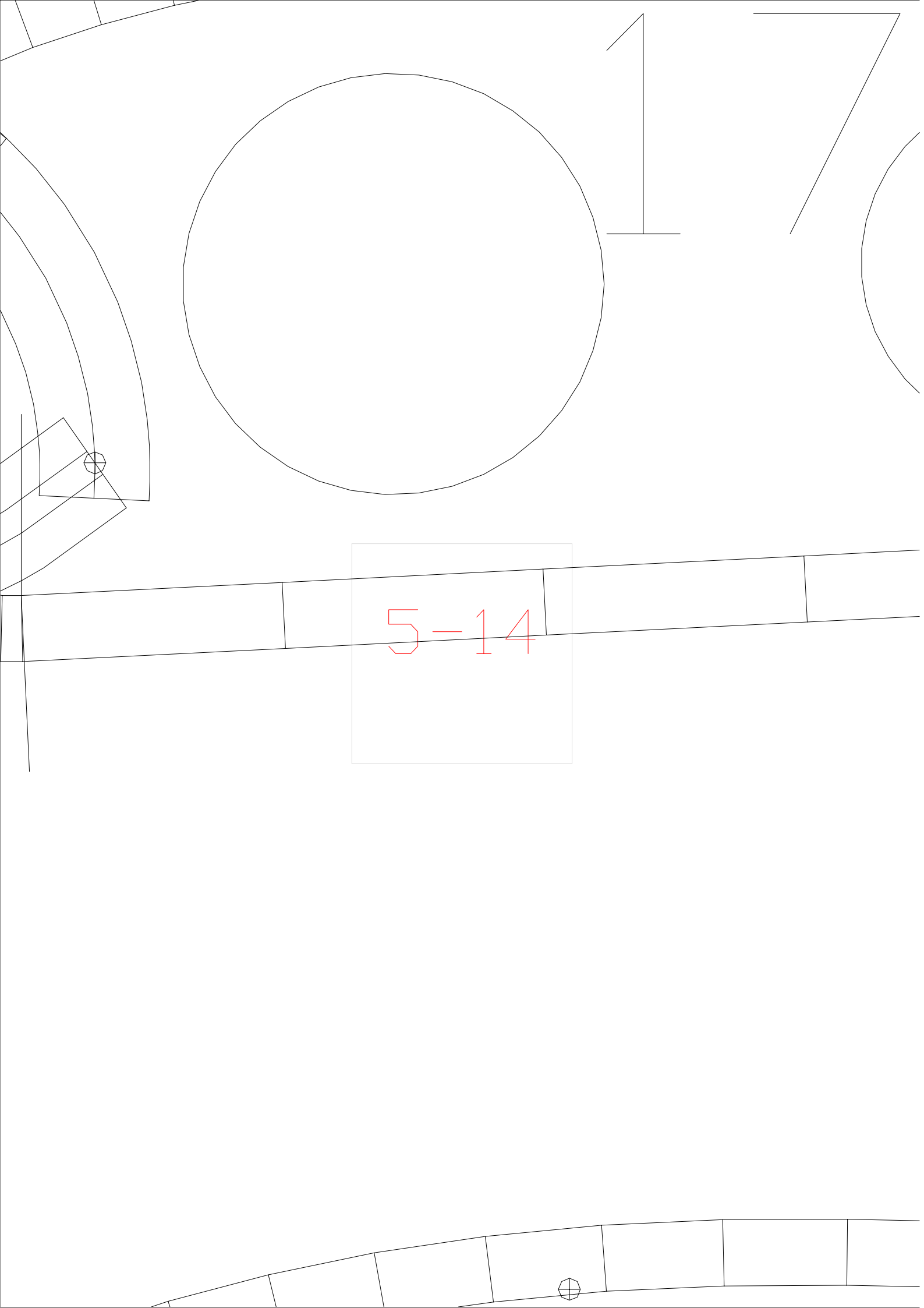

5-14

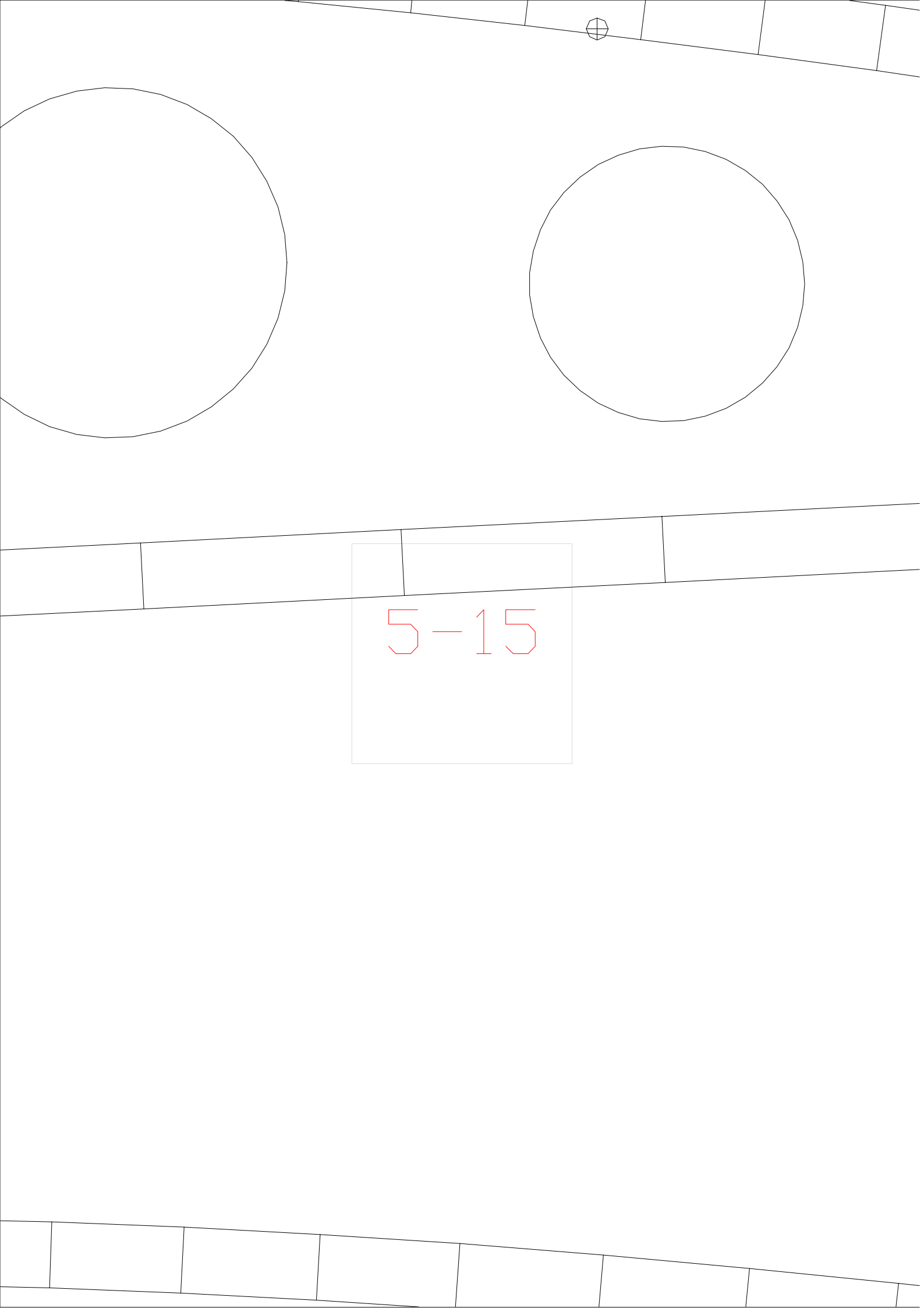

5-15

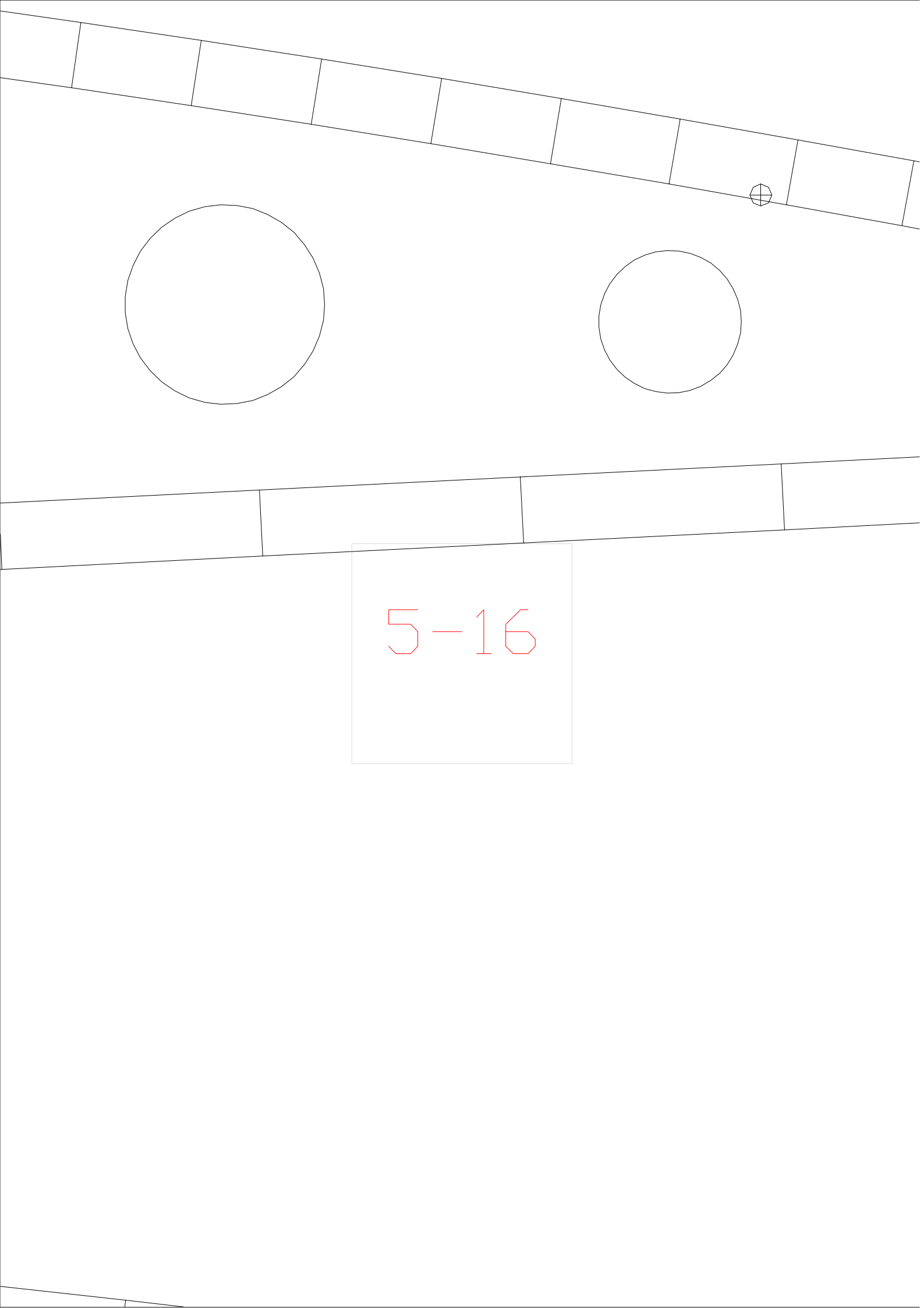

5-16

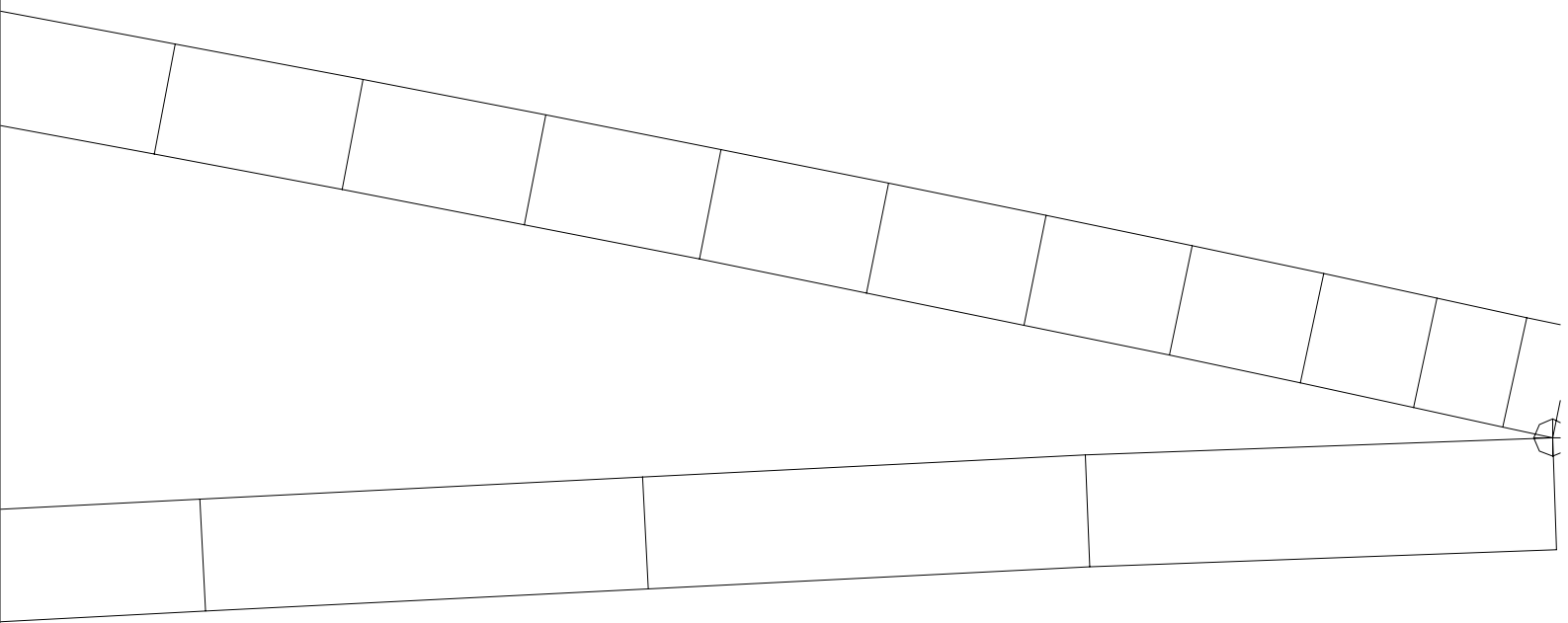

5-17

5-18

5-19

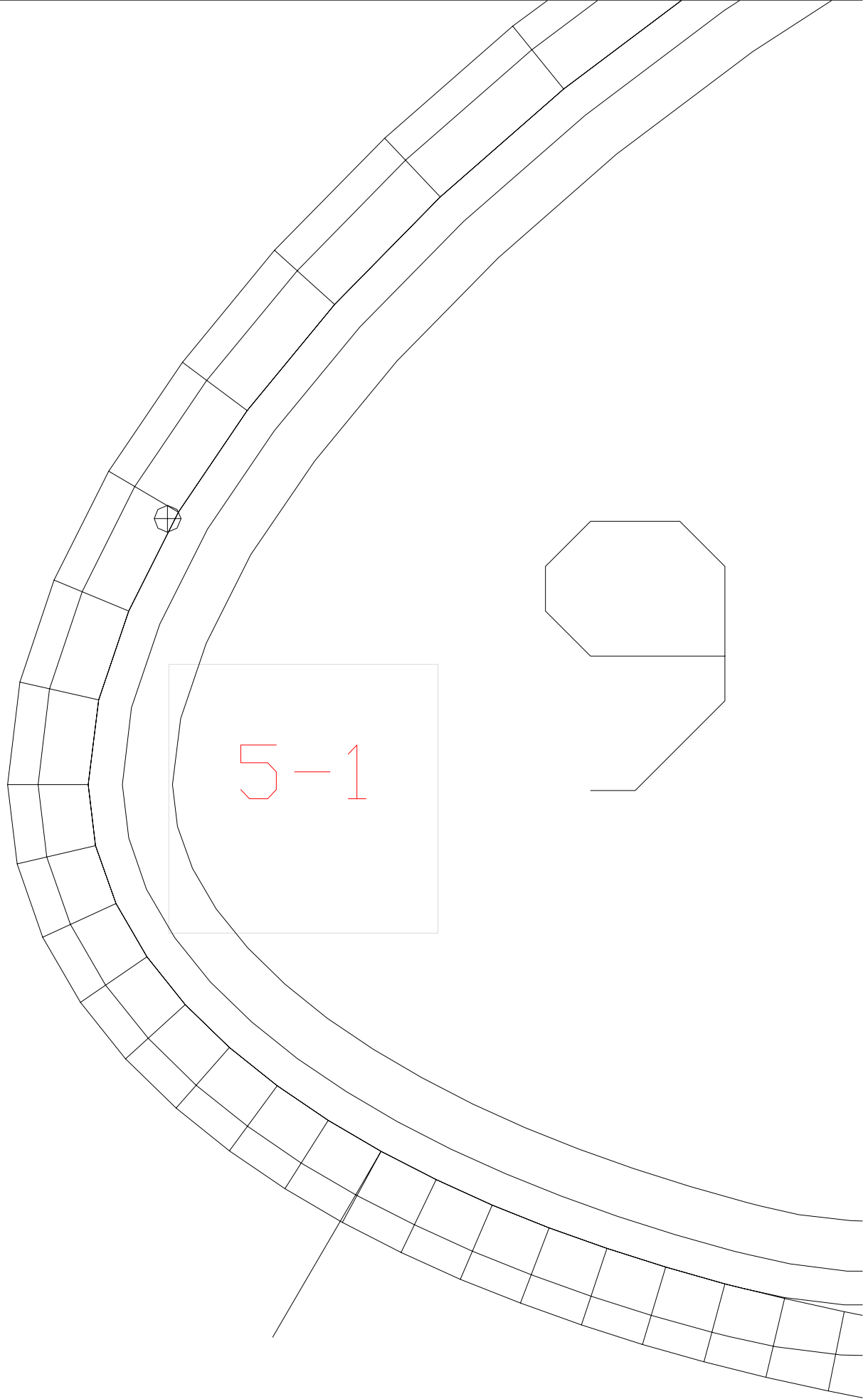

5-1

5-20

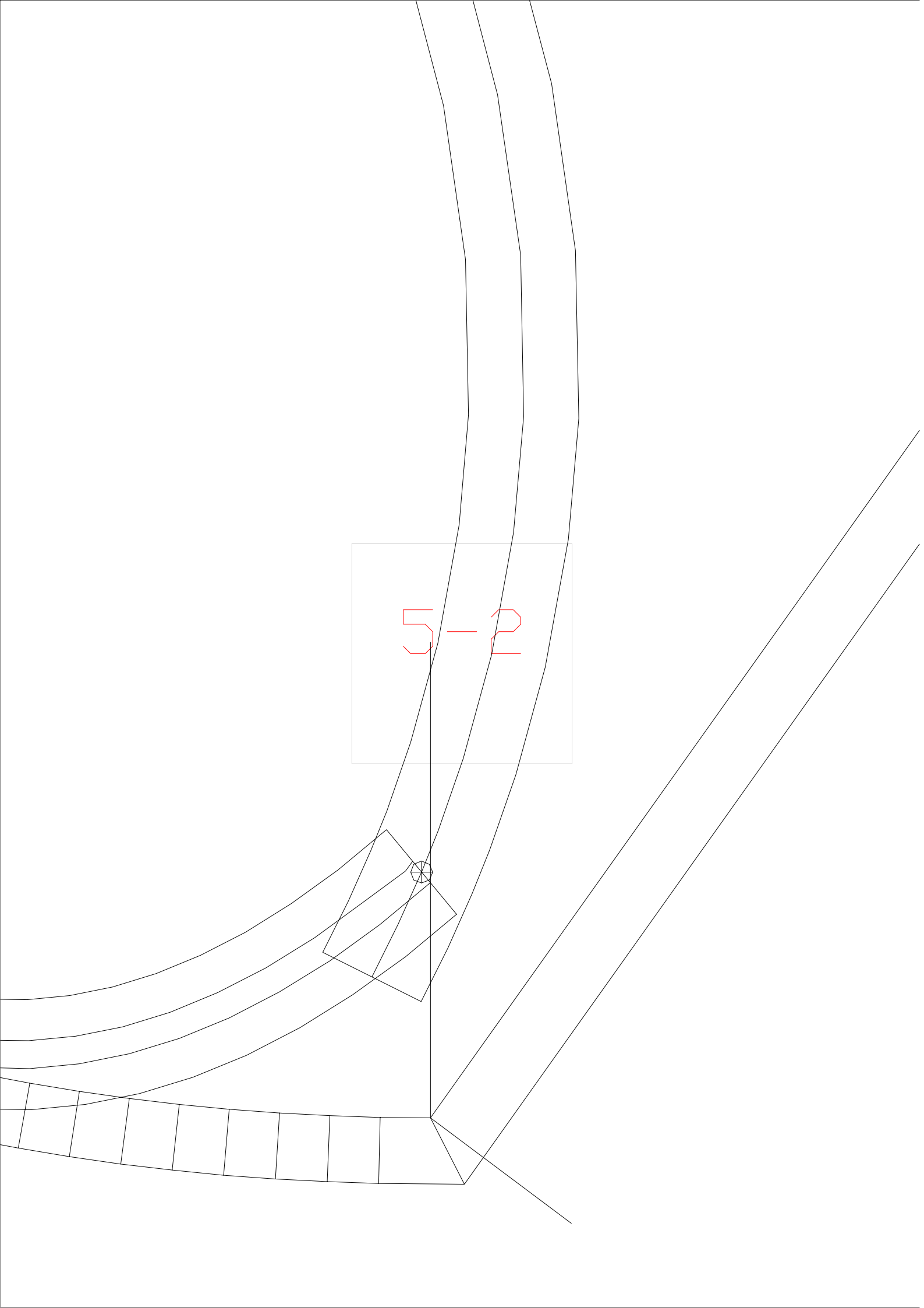

5-3

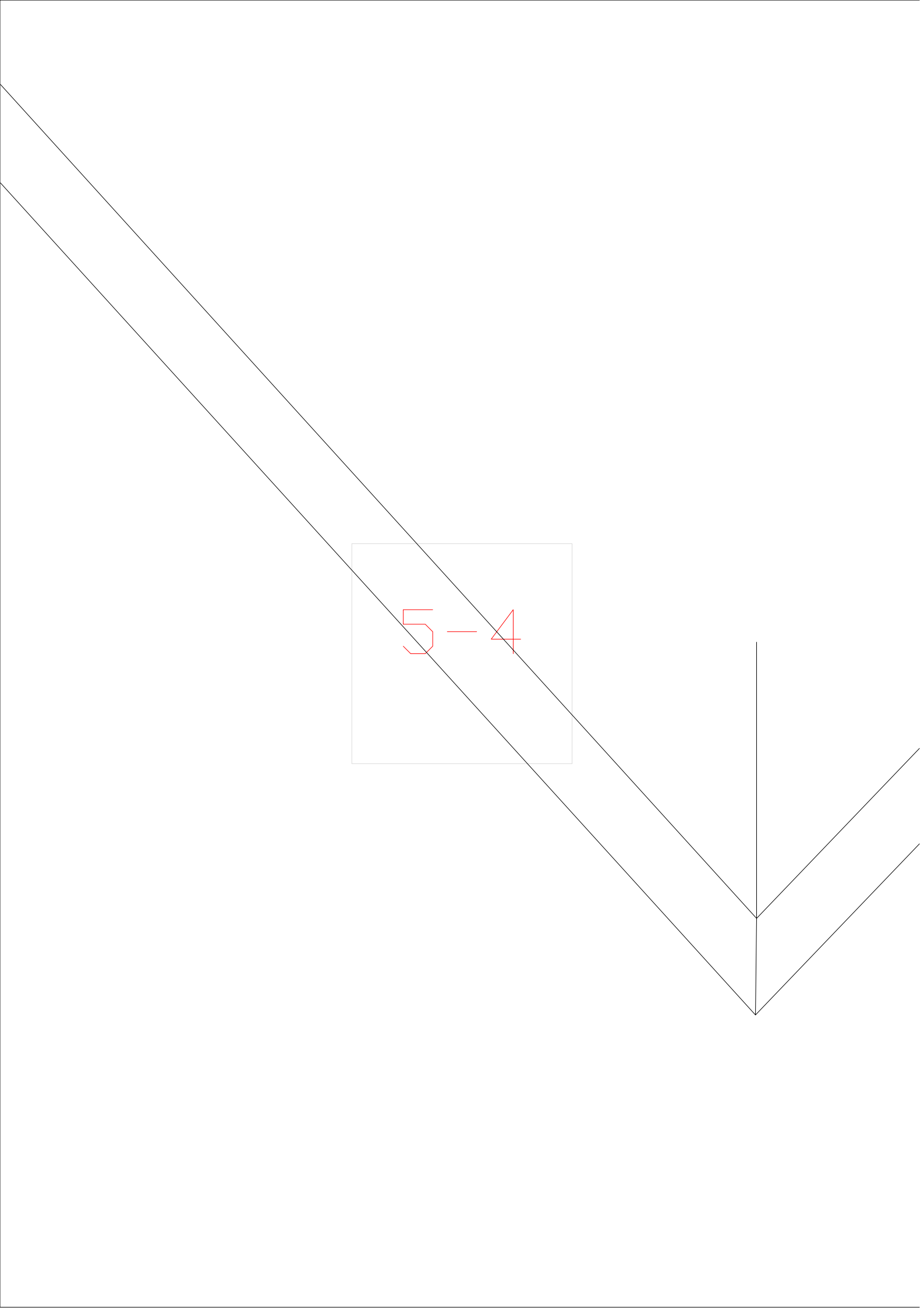



5-5



5-6

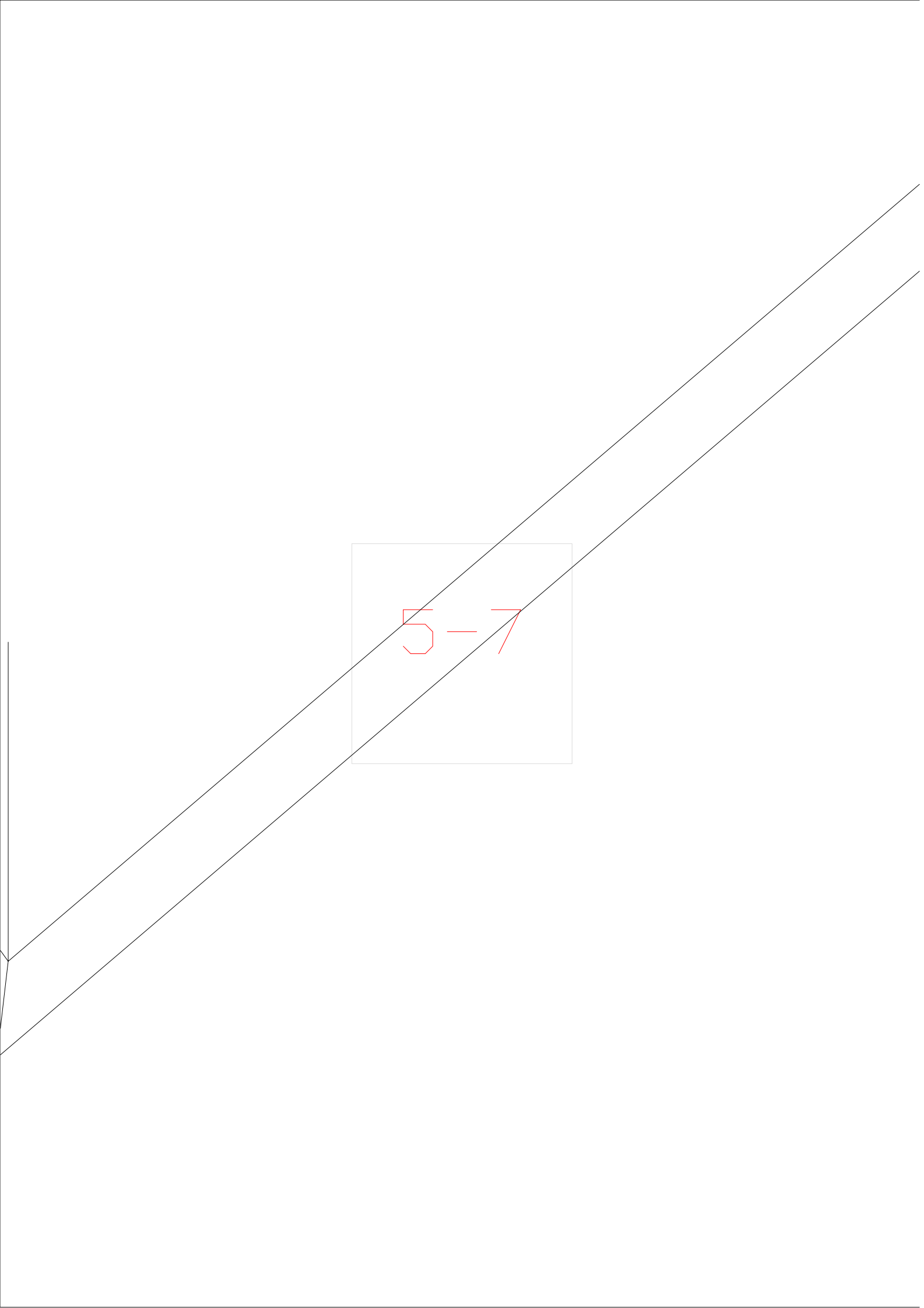

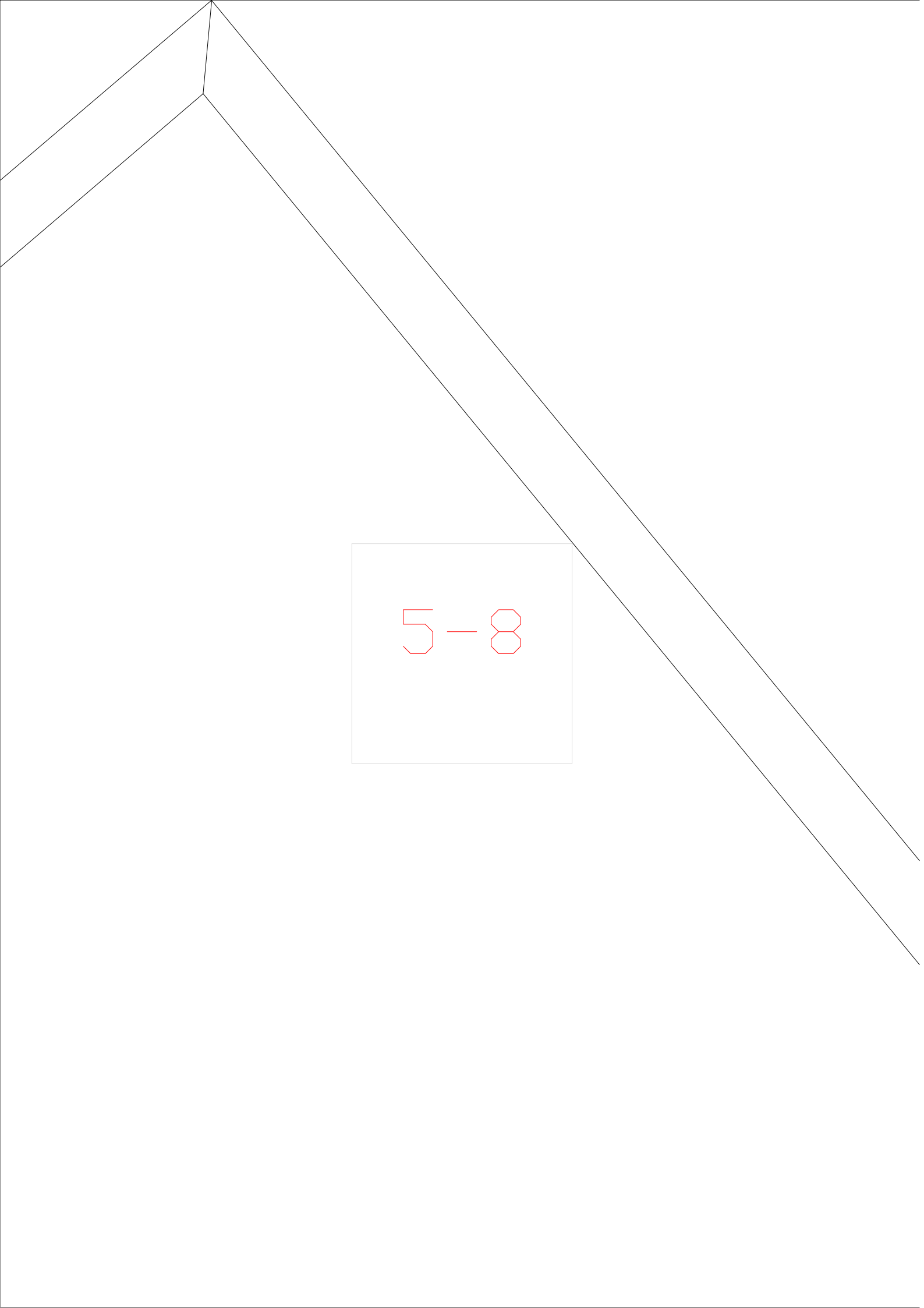

5-8



5-9

6-10



6-11



6-12

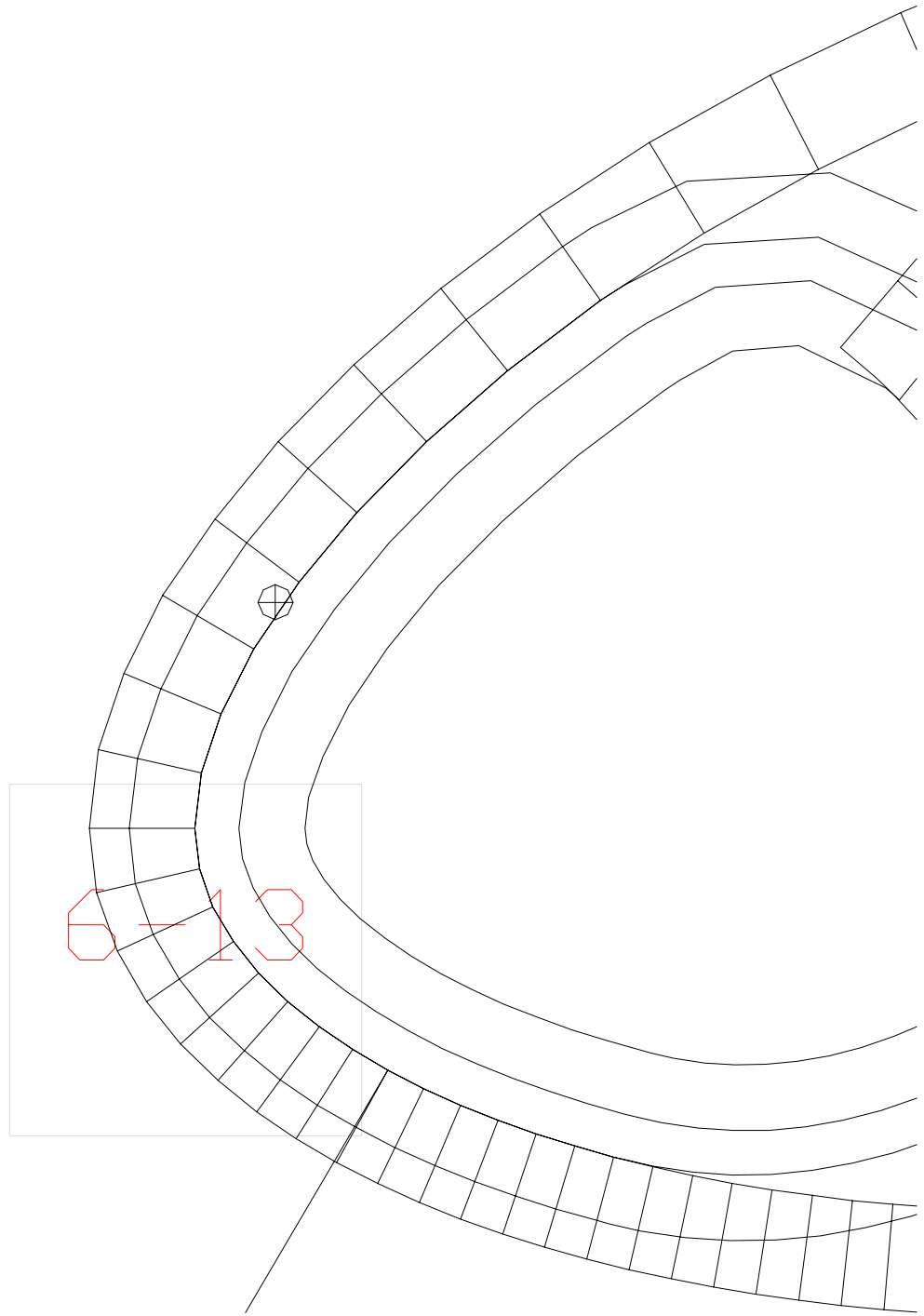

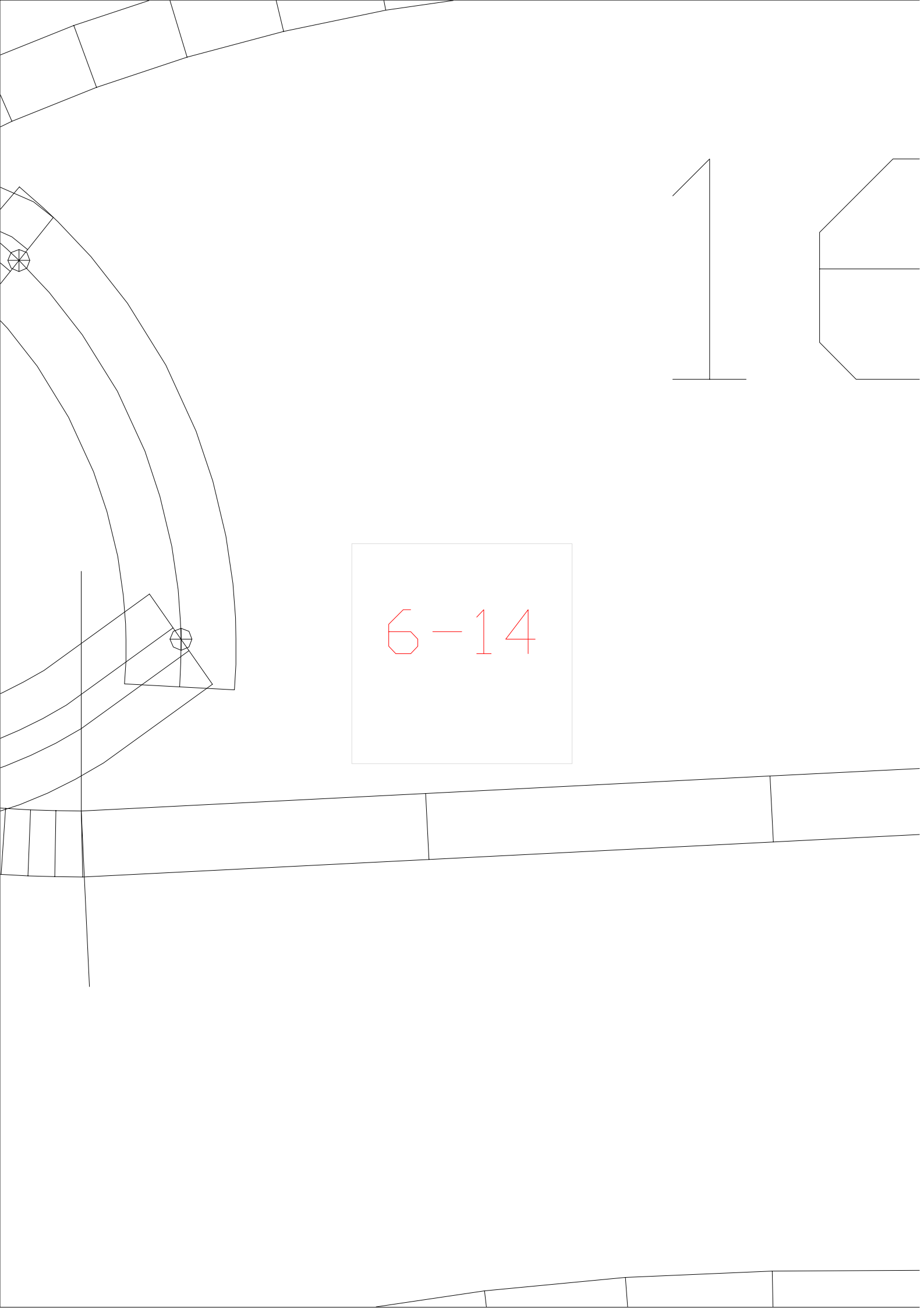

6-14

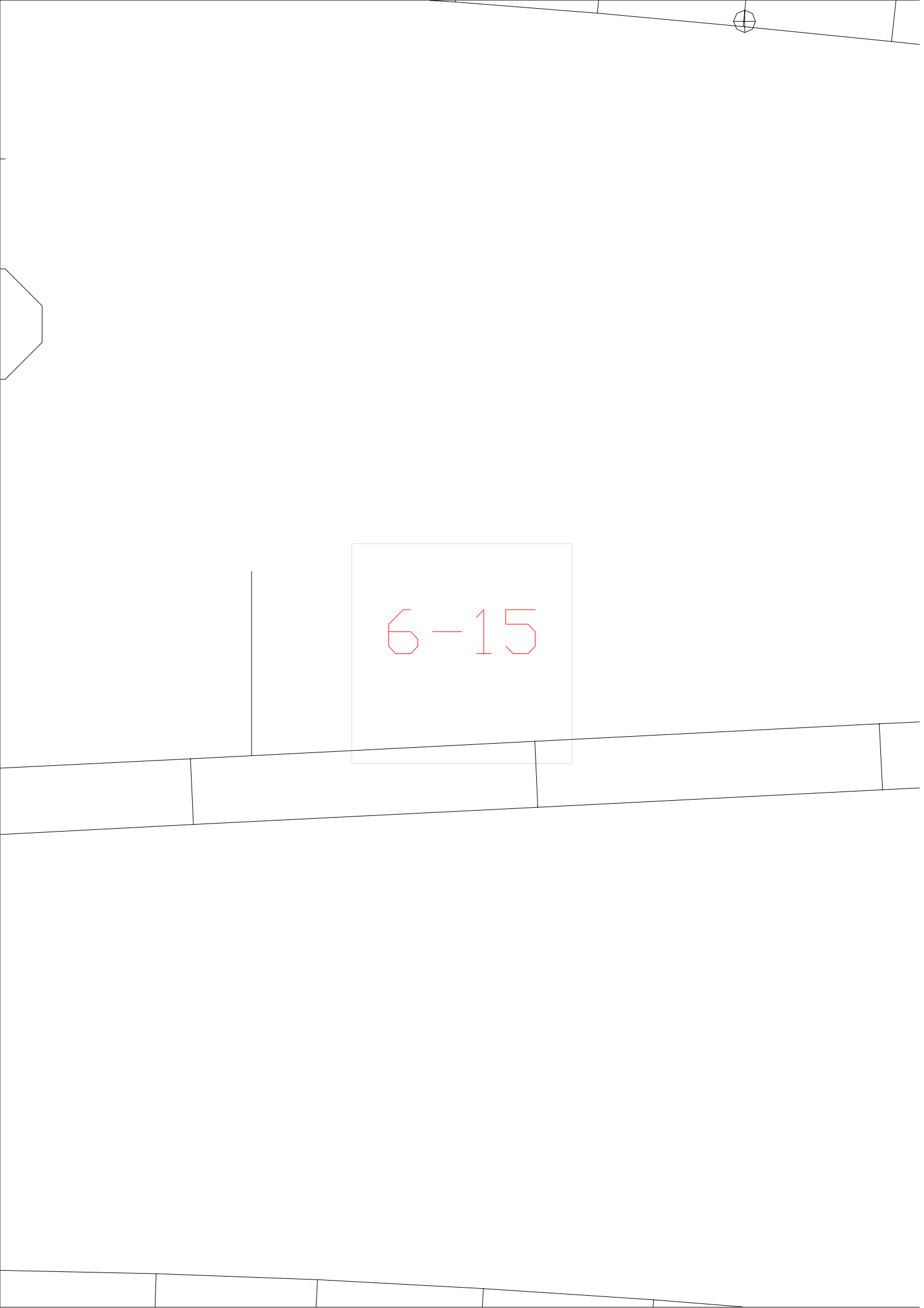

6-15

--	--	--	--	--	--	--

$6-16$

--	--	--	--

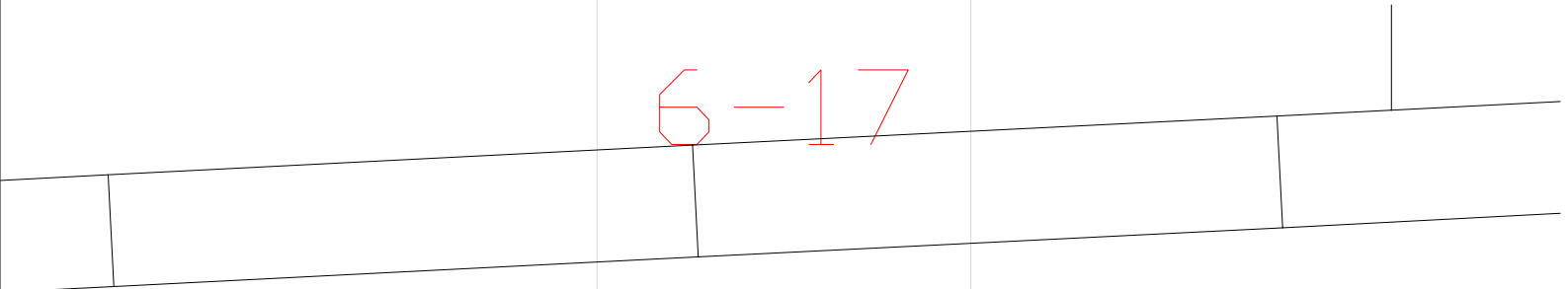
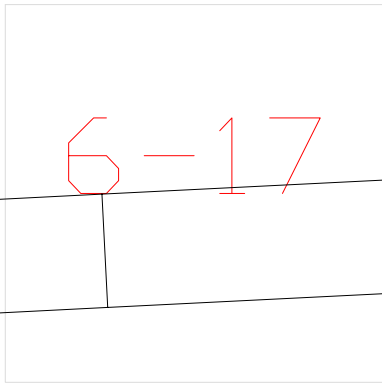
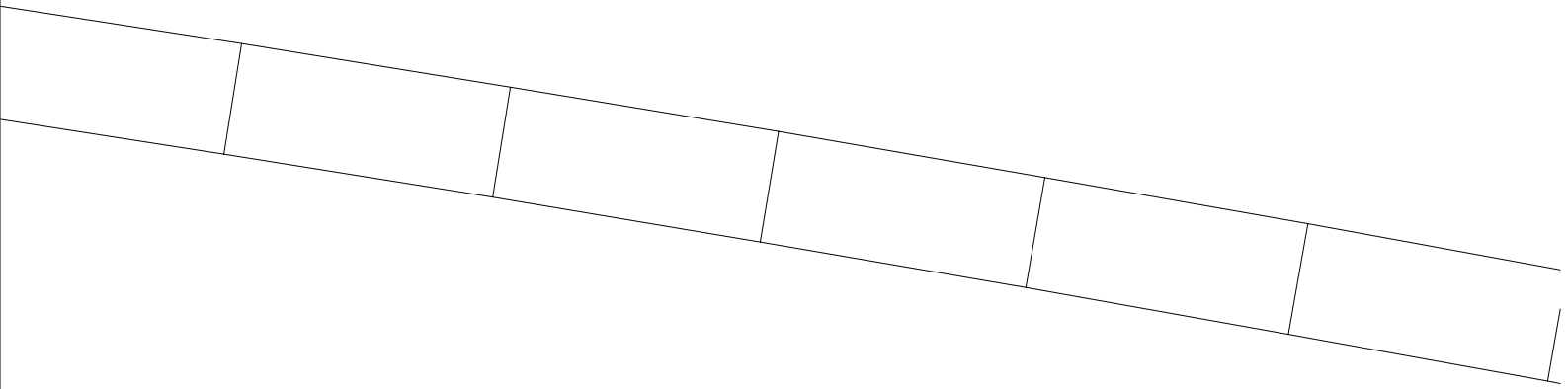

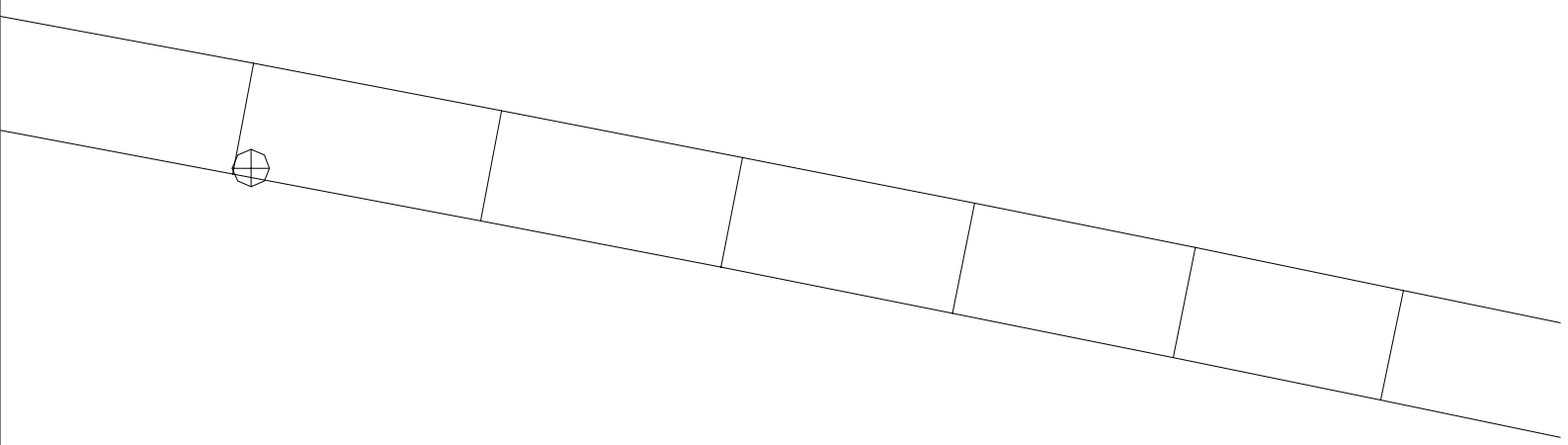

6-18

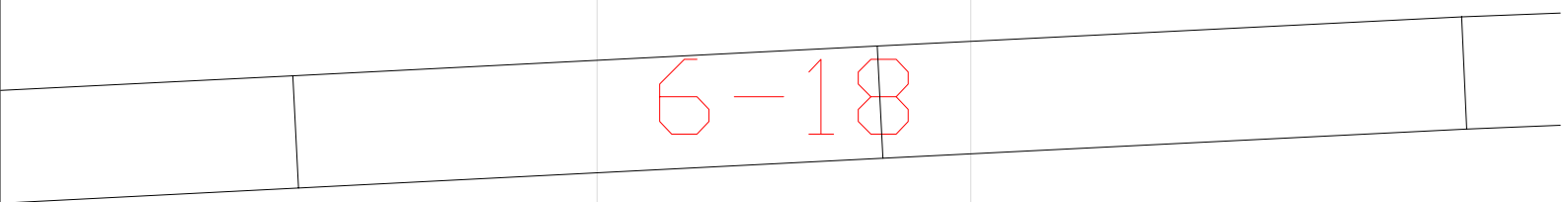

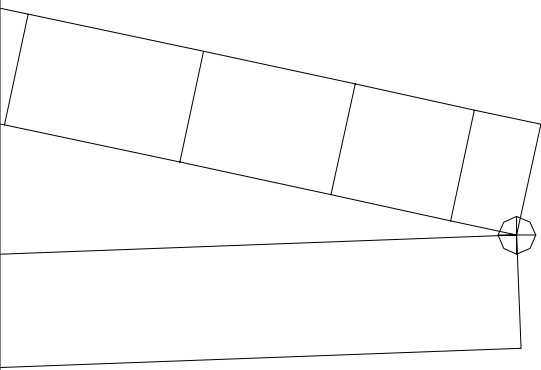

6-19

6-1

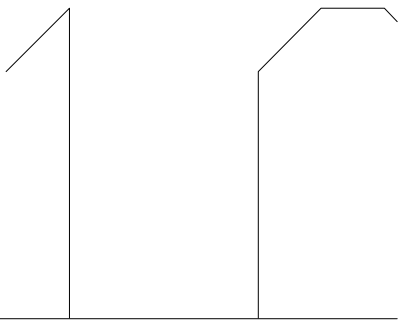
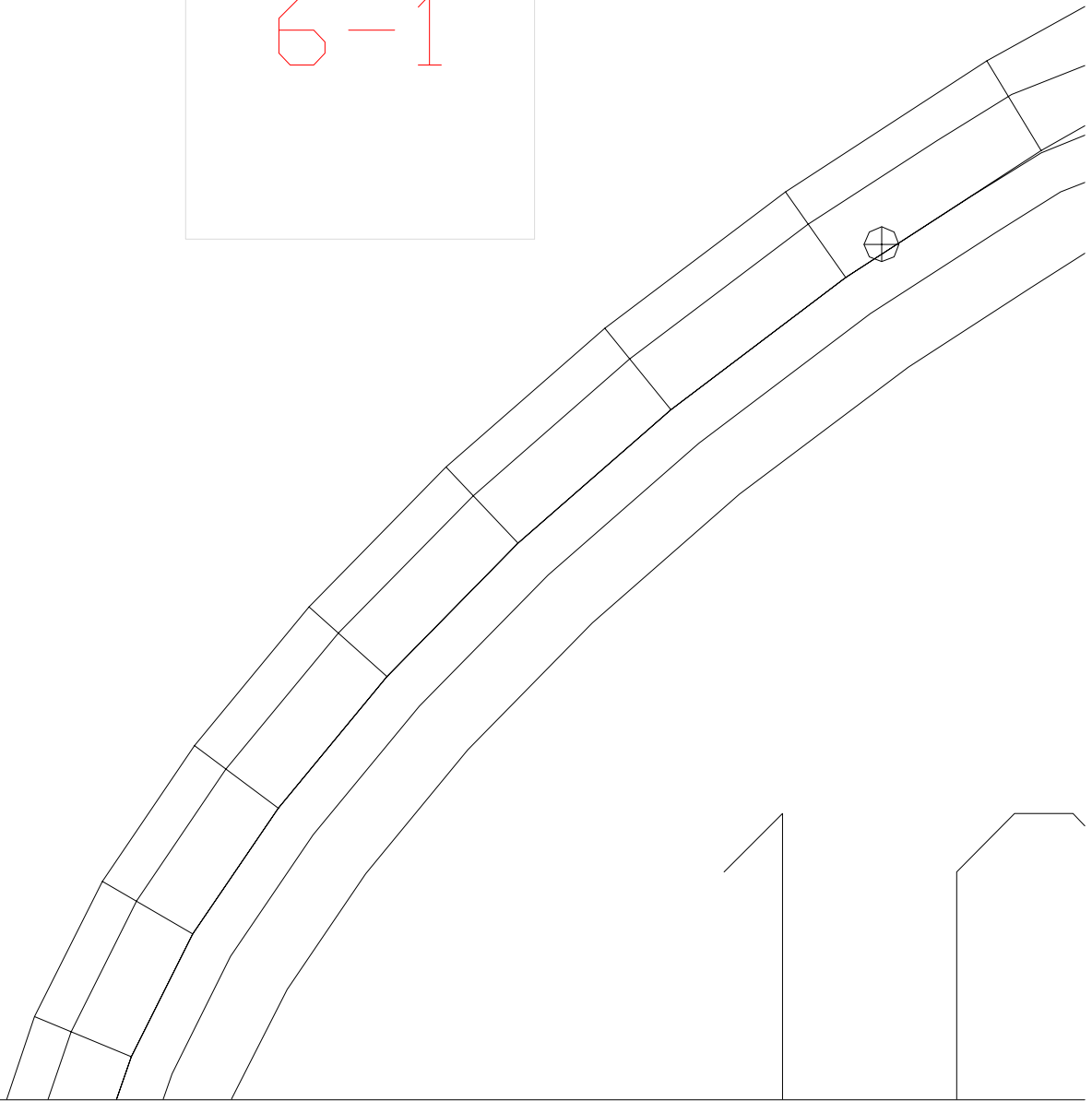

6-20

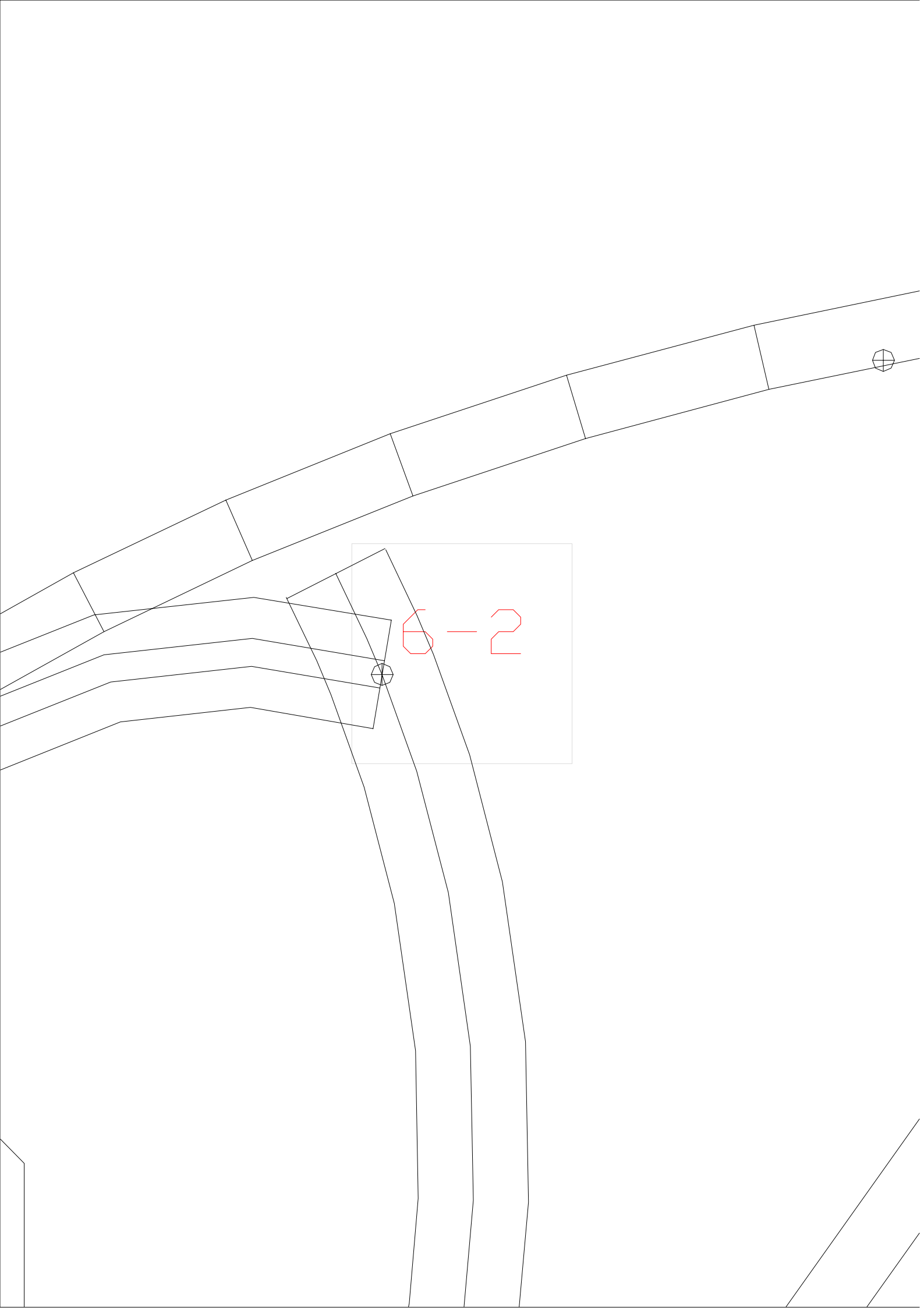

E-2

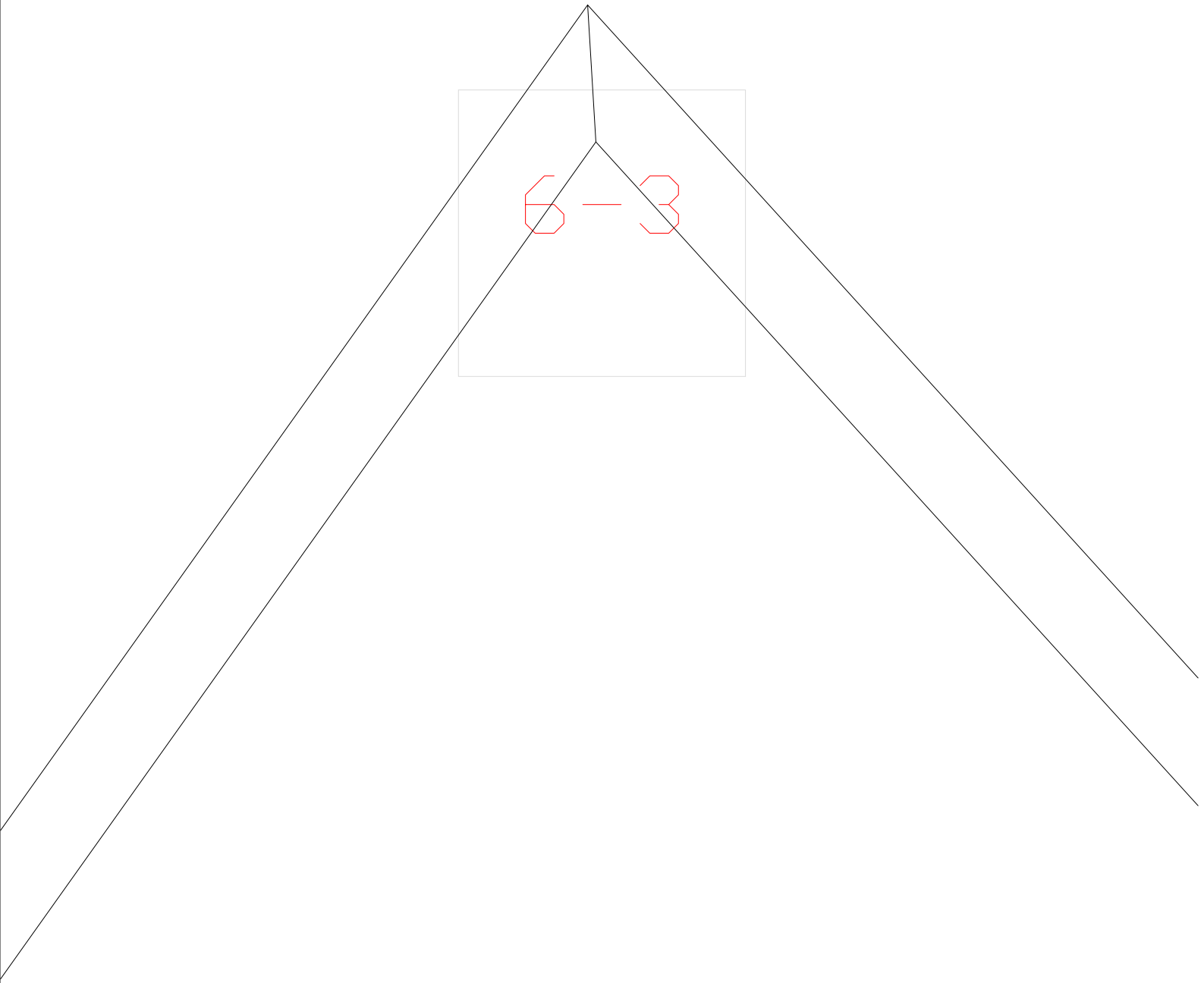
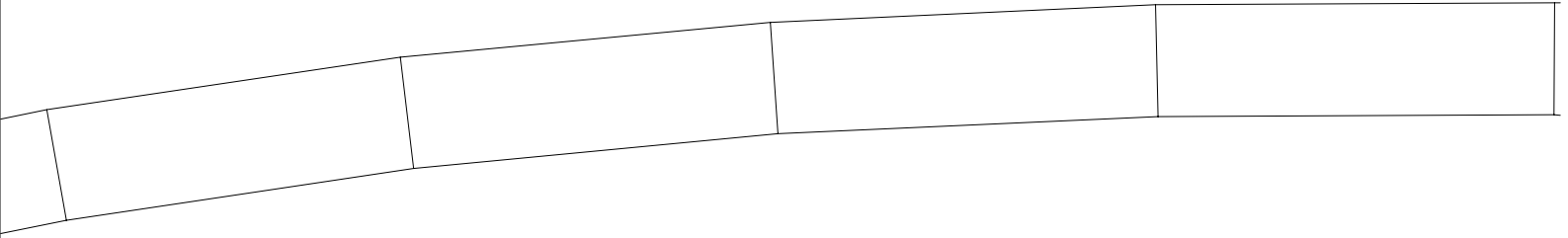

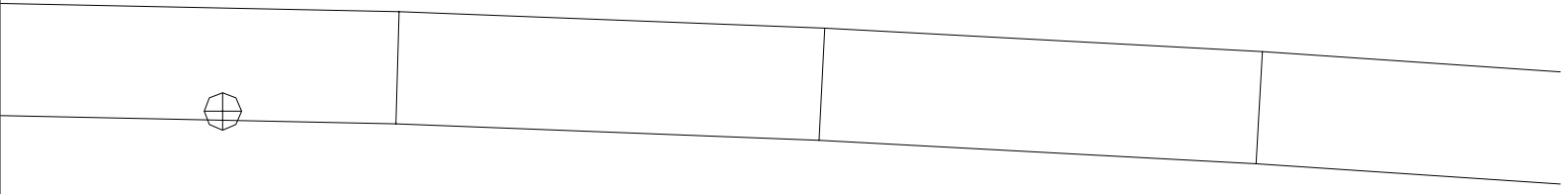

6-4

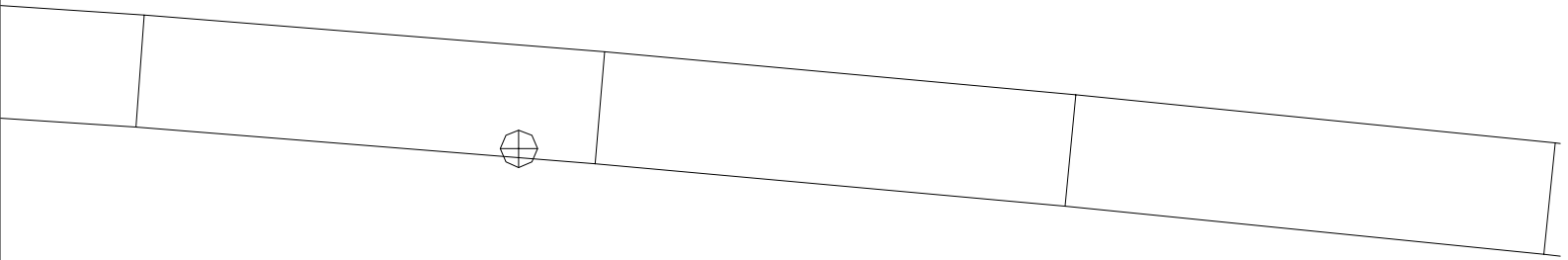

6-5

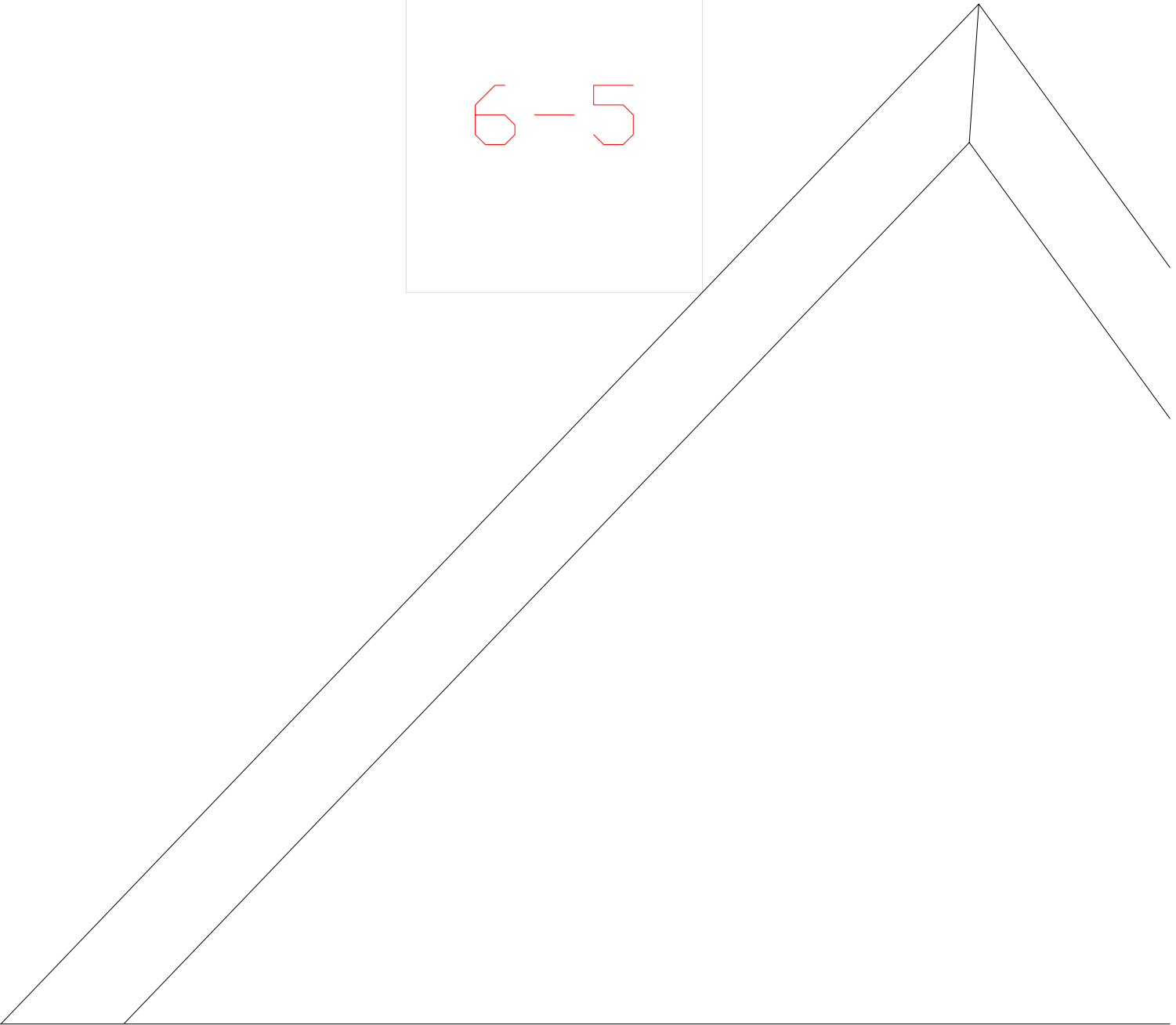

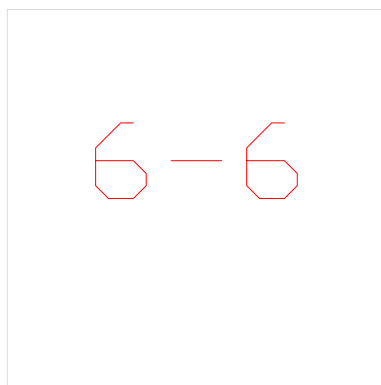
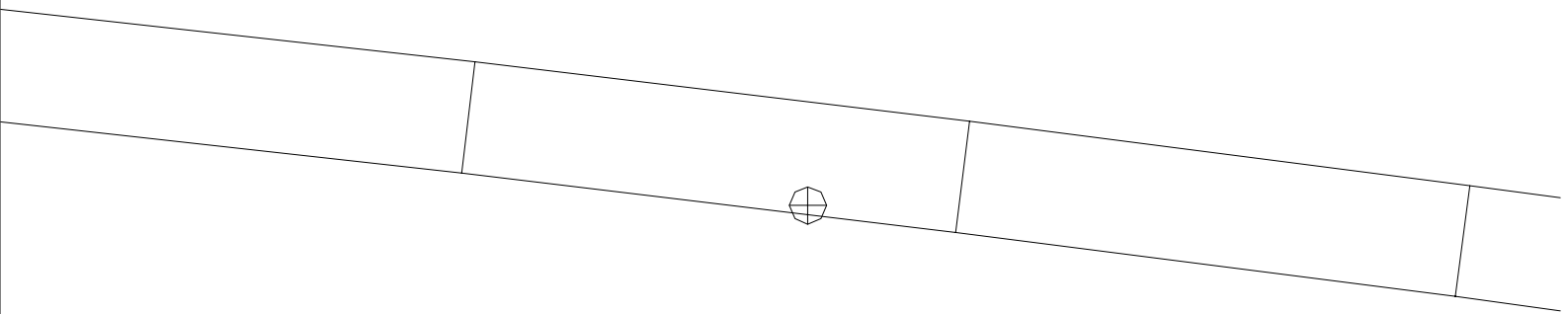

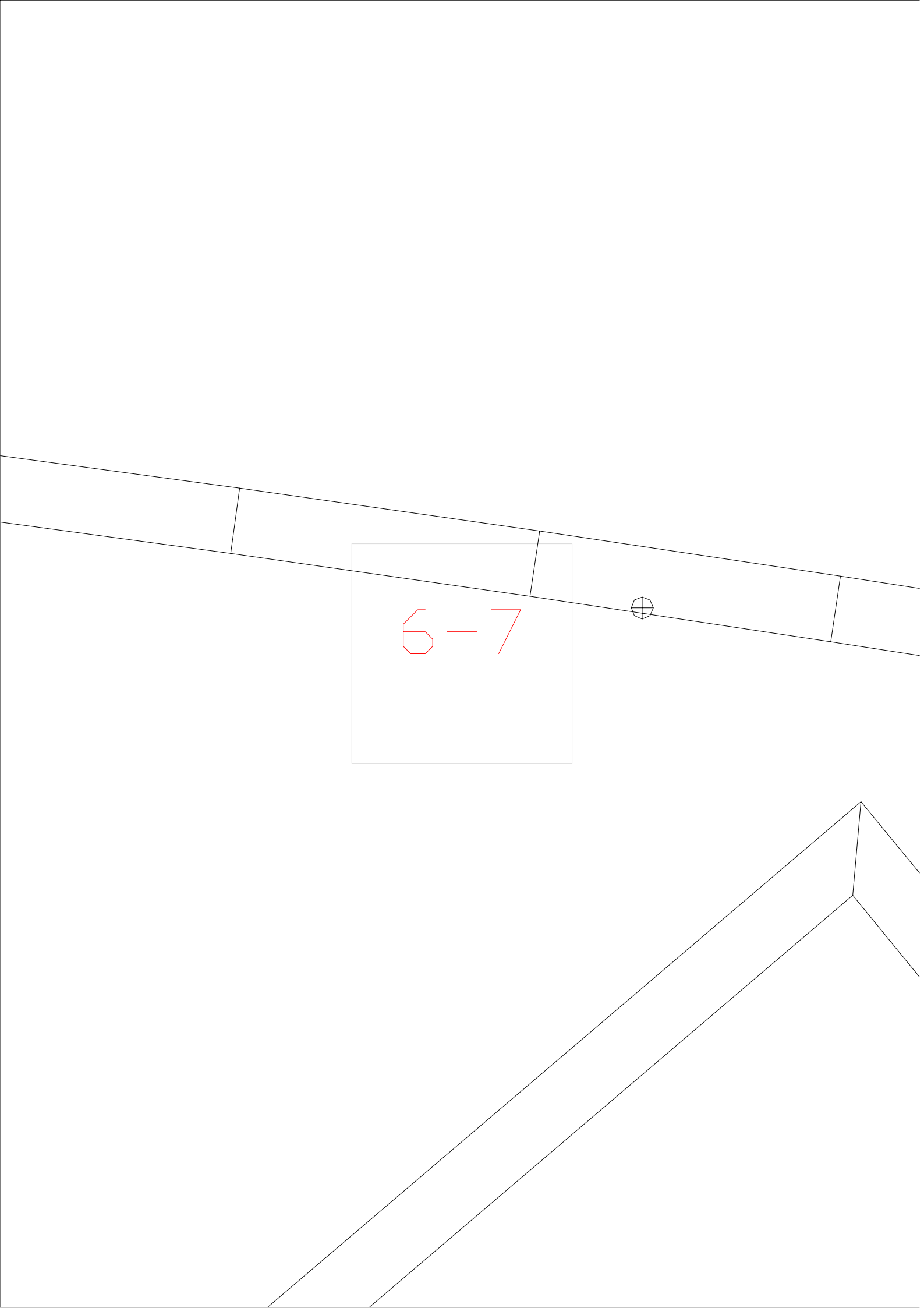



6-8

The image shows a technical drawing of a tapered shaft. The shaft is oriented horizontally and tapers from left to right. It features a central longitudinal hole. The right end of the shaft is chamfered, with a chamfered surface indicated by a dashed line. A small circle with a cross inside is located on the chamfered surface, representing a hole or a specific feature. A rectangular box is drawn around the central part of the shaft, containing the red text '6-8'. The drawing is composed of black lines on a white background.

6-9

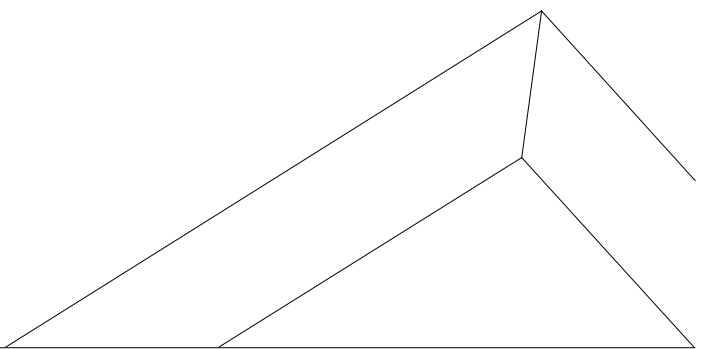
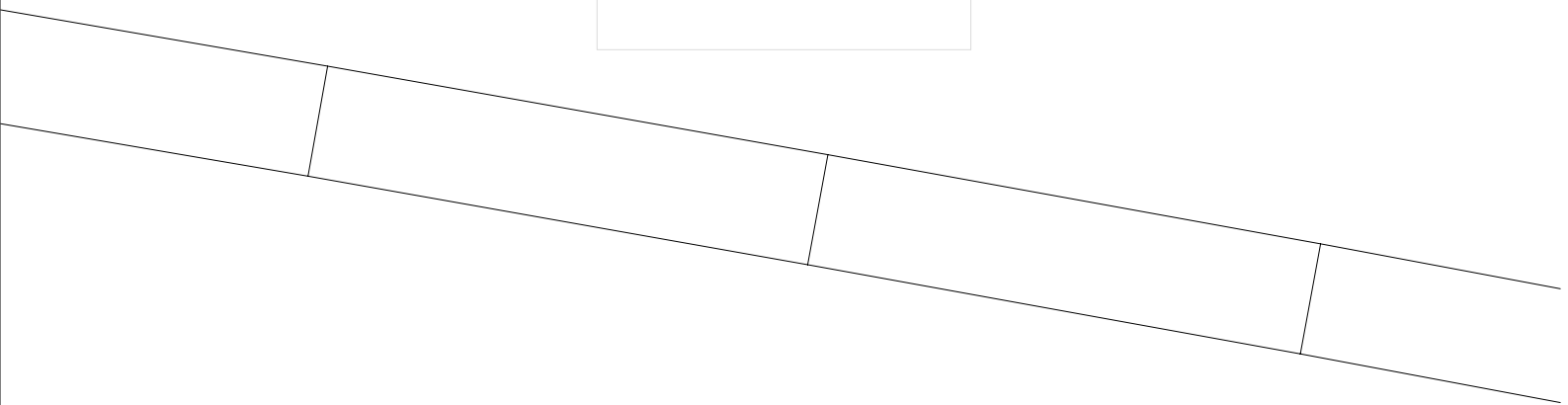

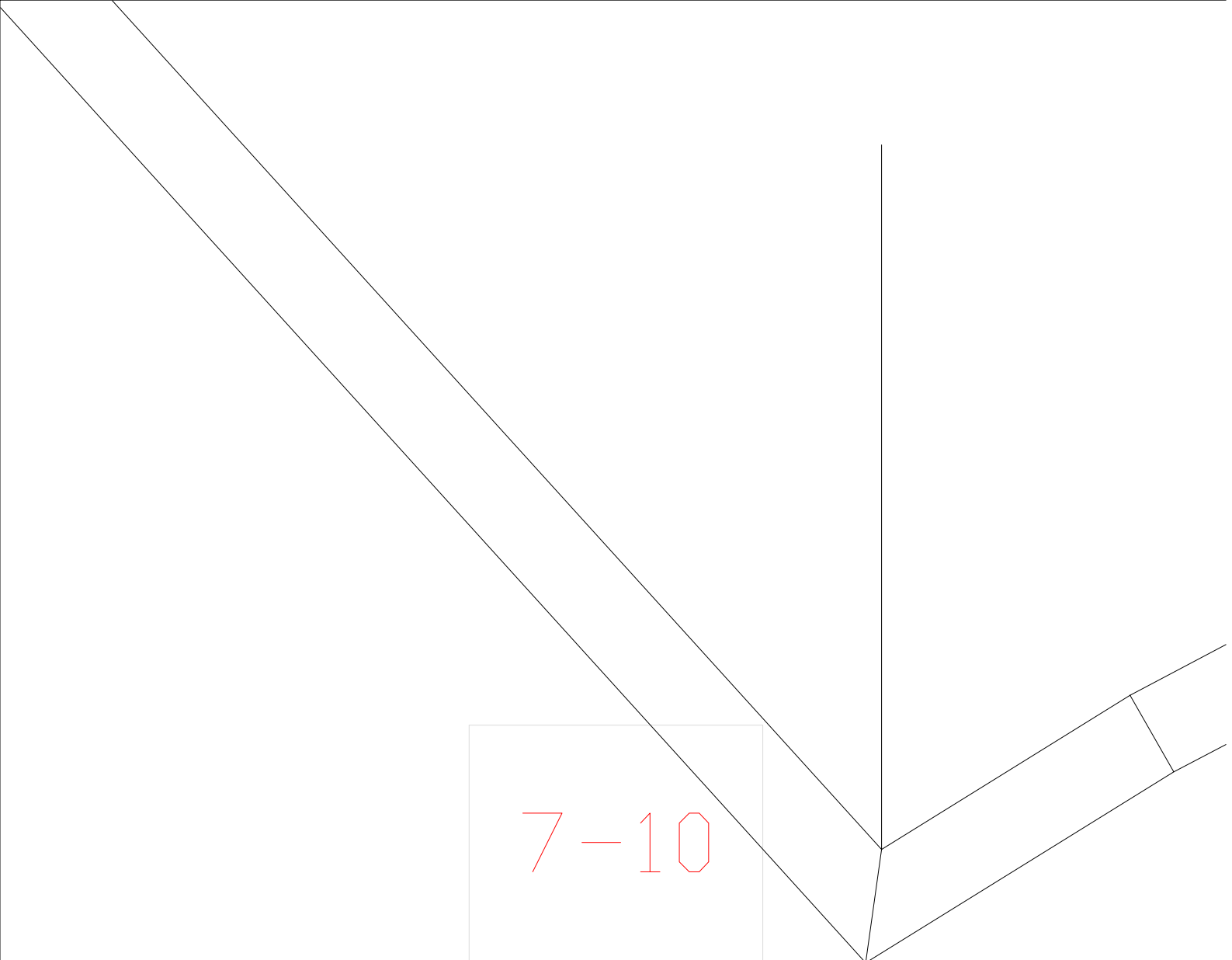

7-10

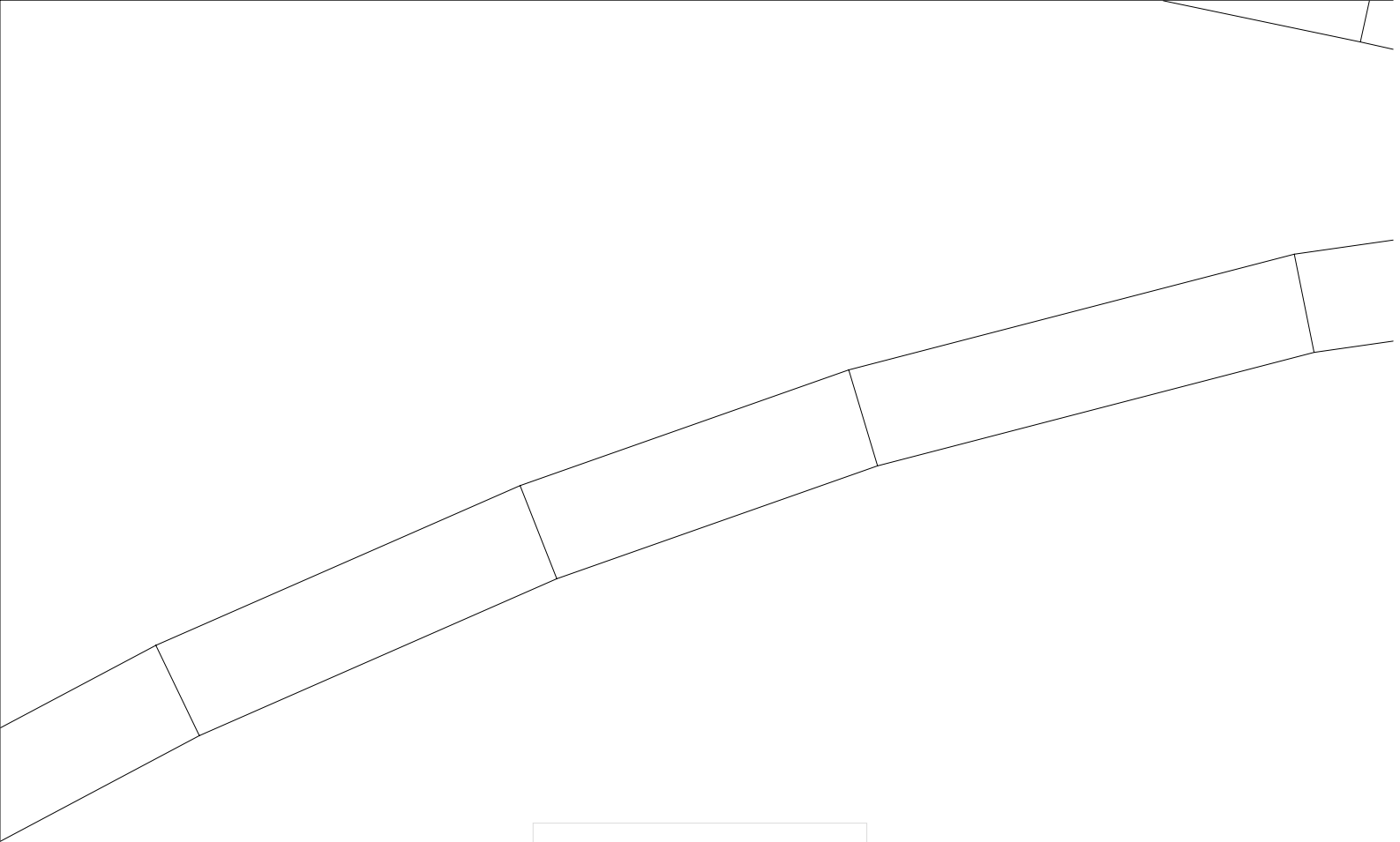

7-11

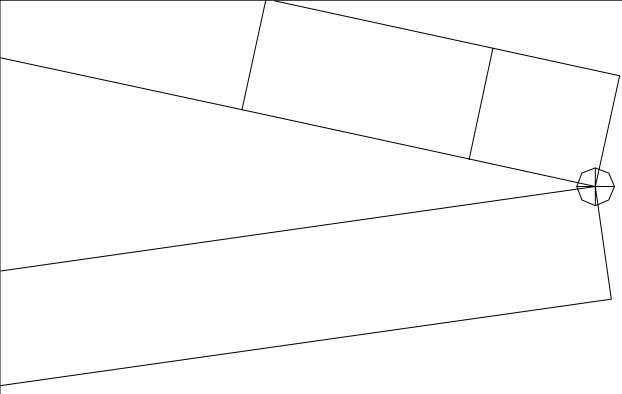

7-12

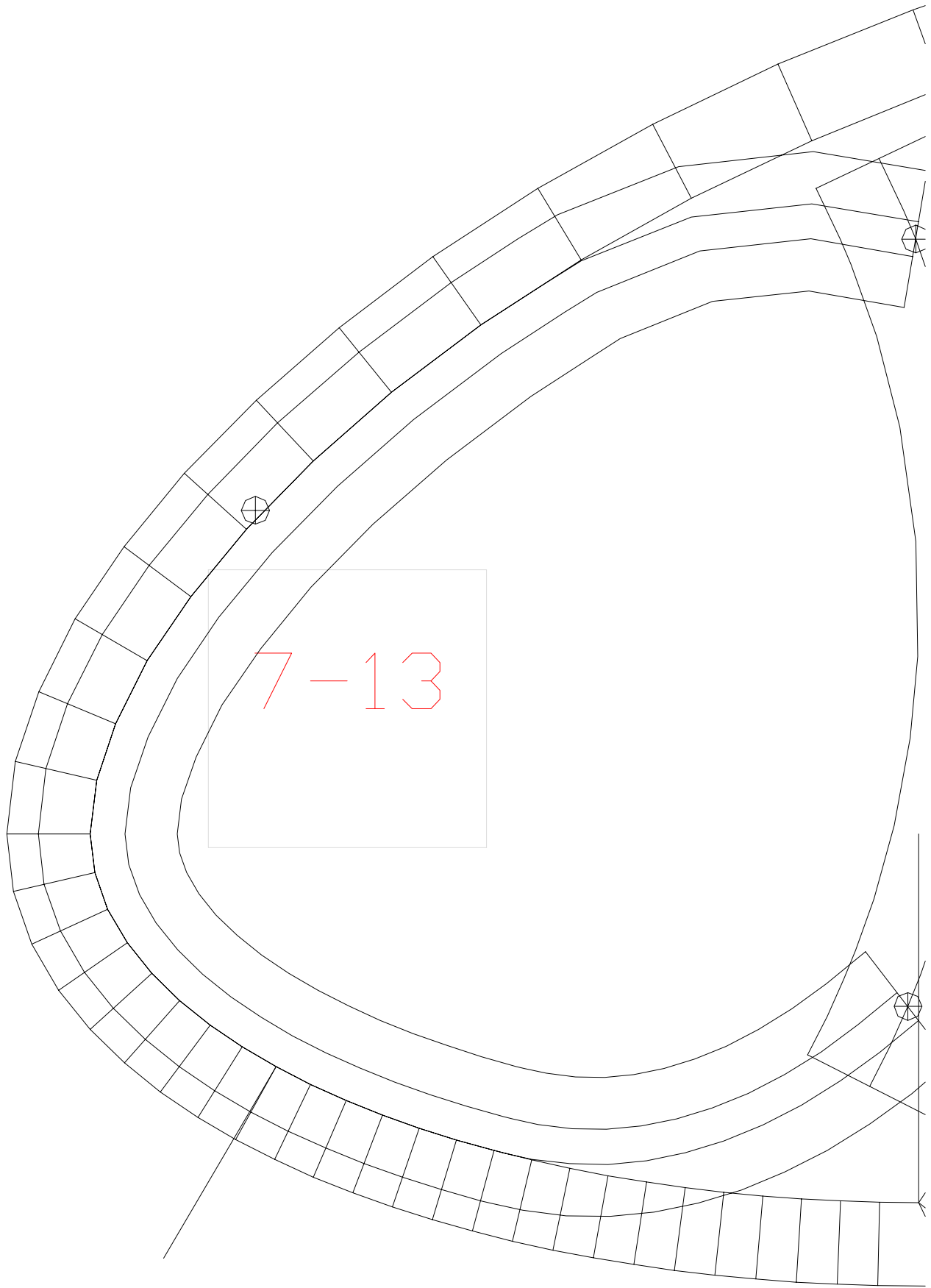

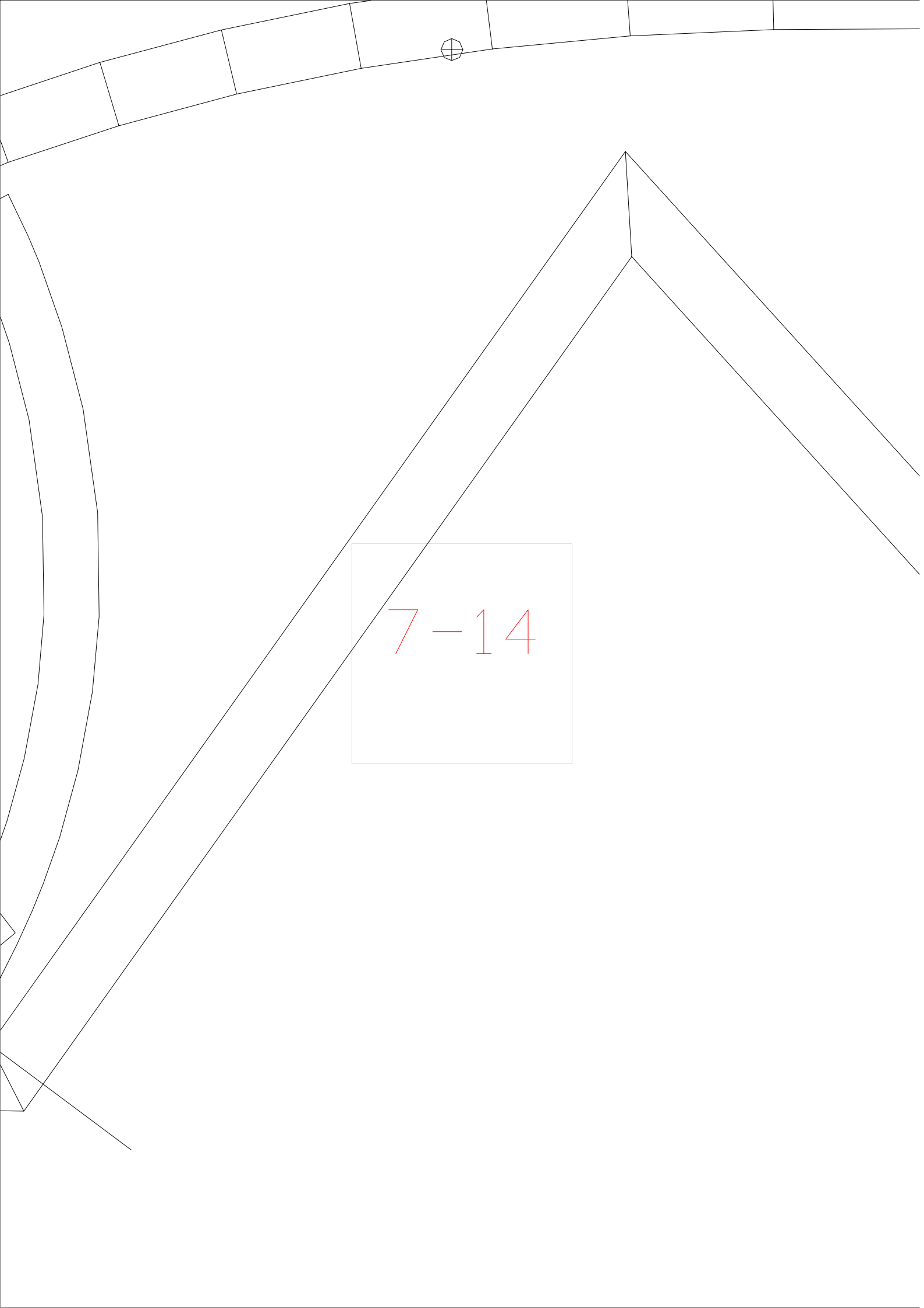

7-14

15

7-15

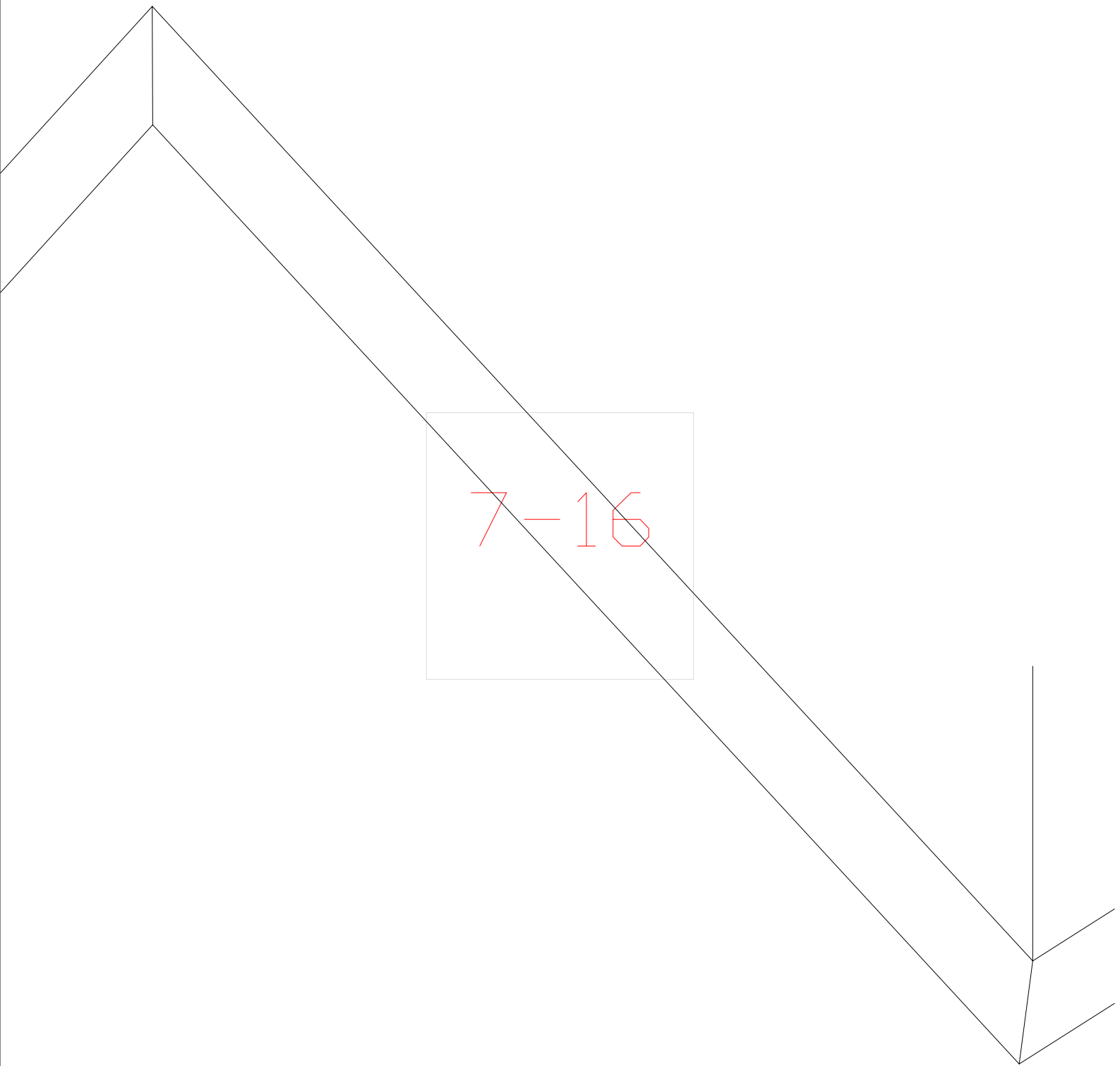
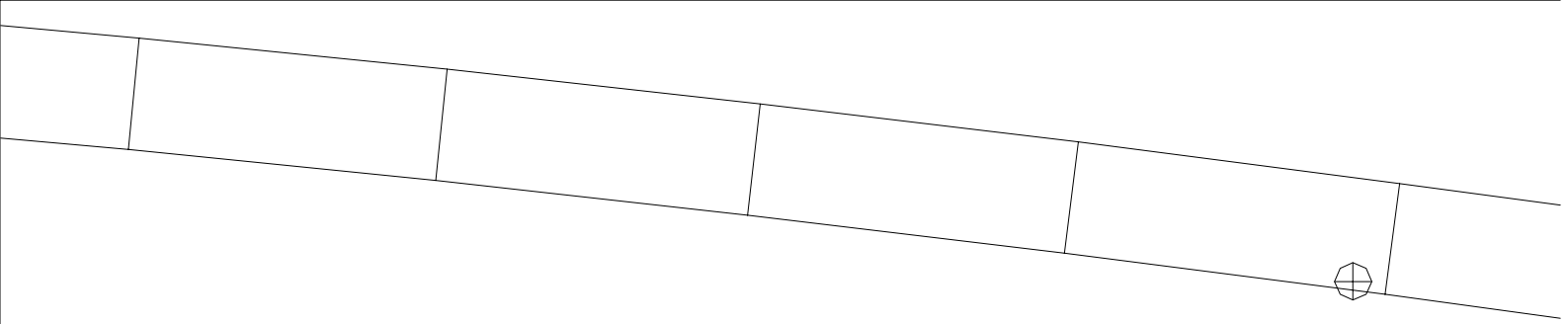

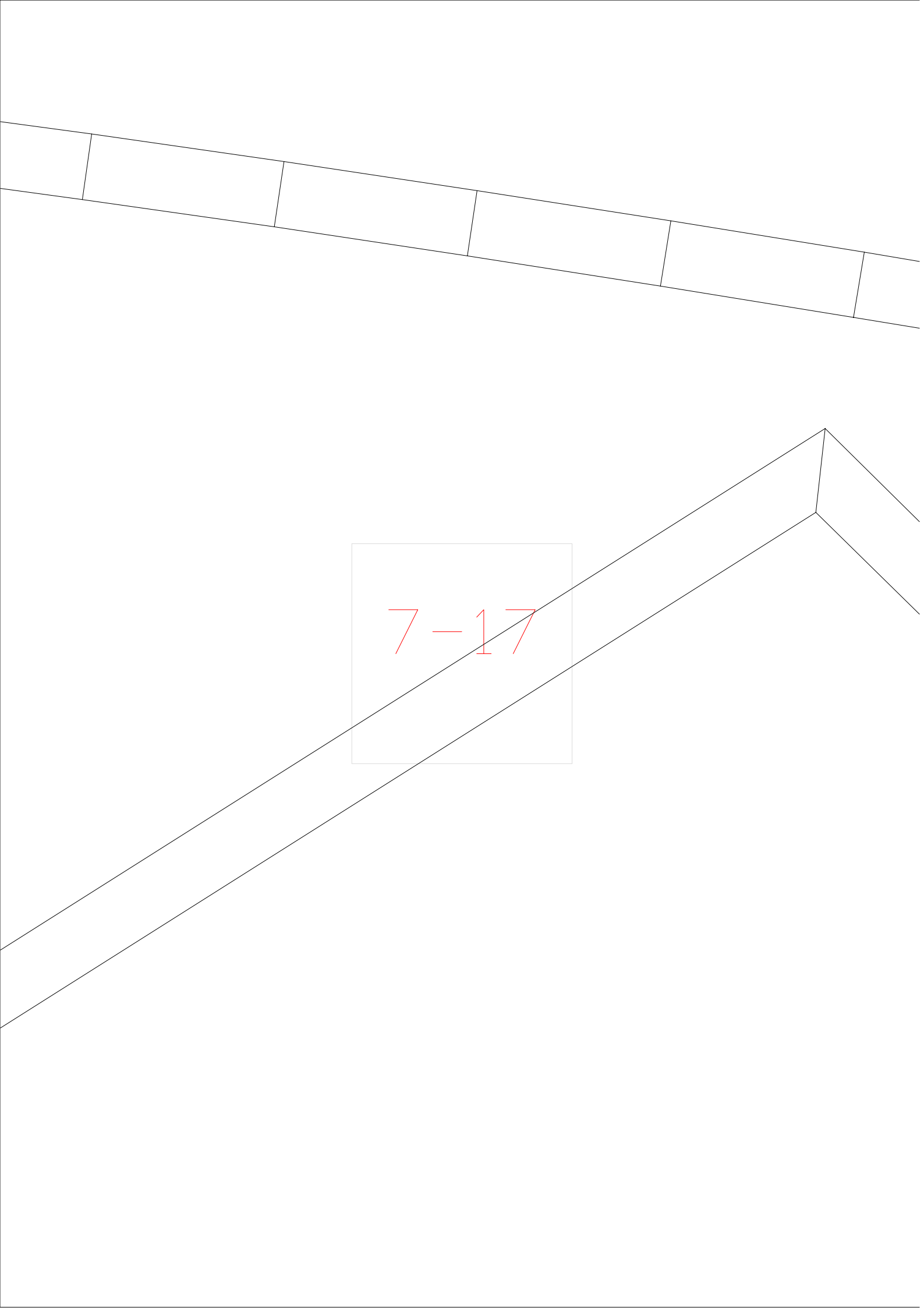

7-17

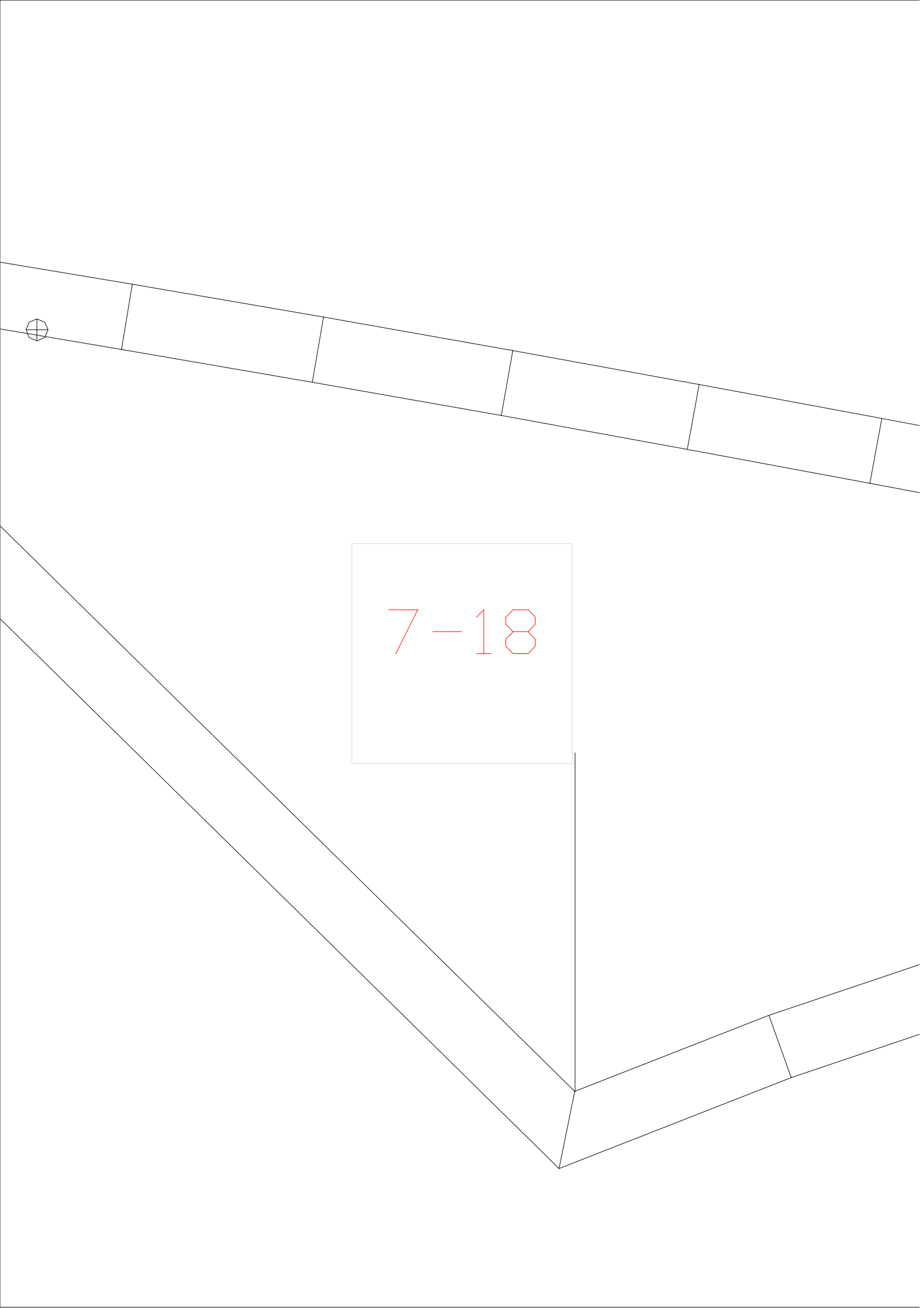

7-18

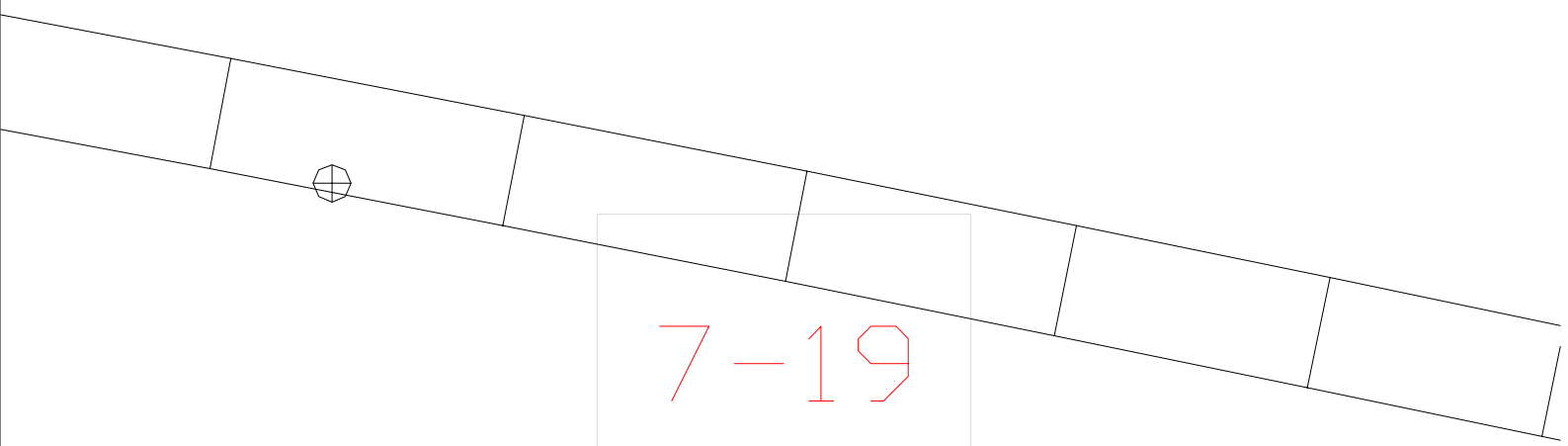

7-19

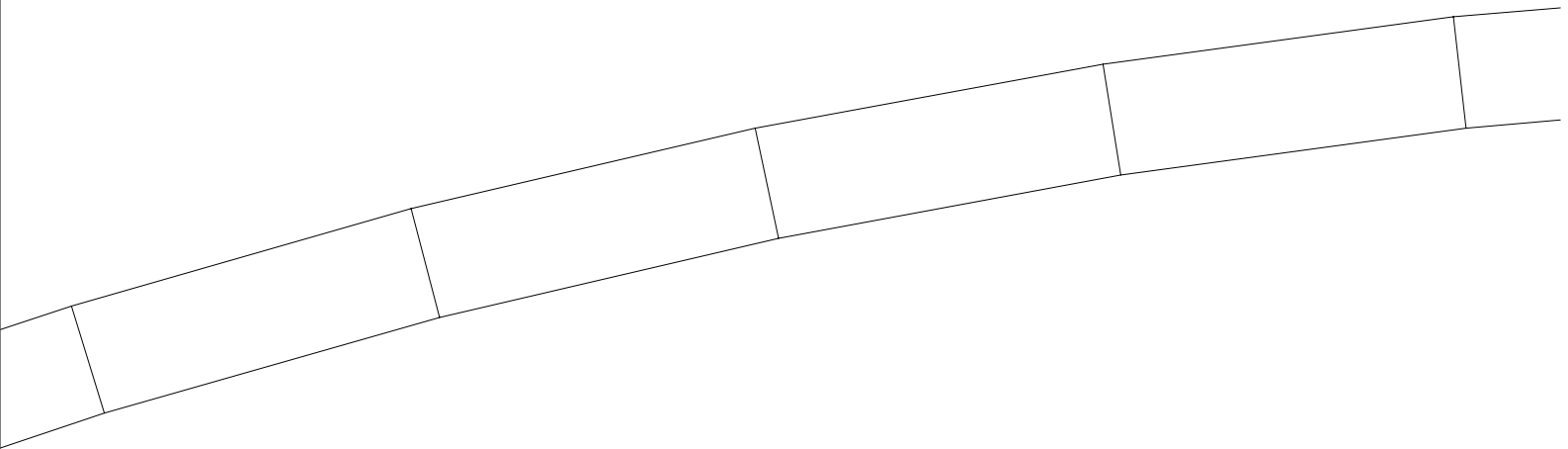

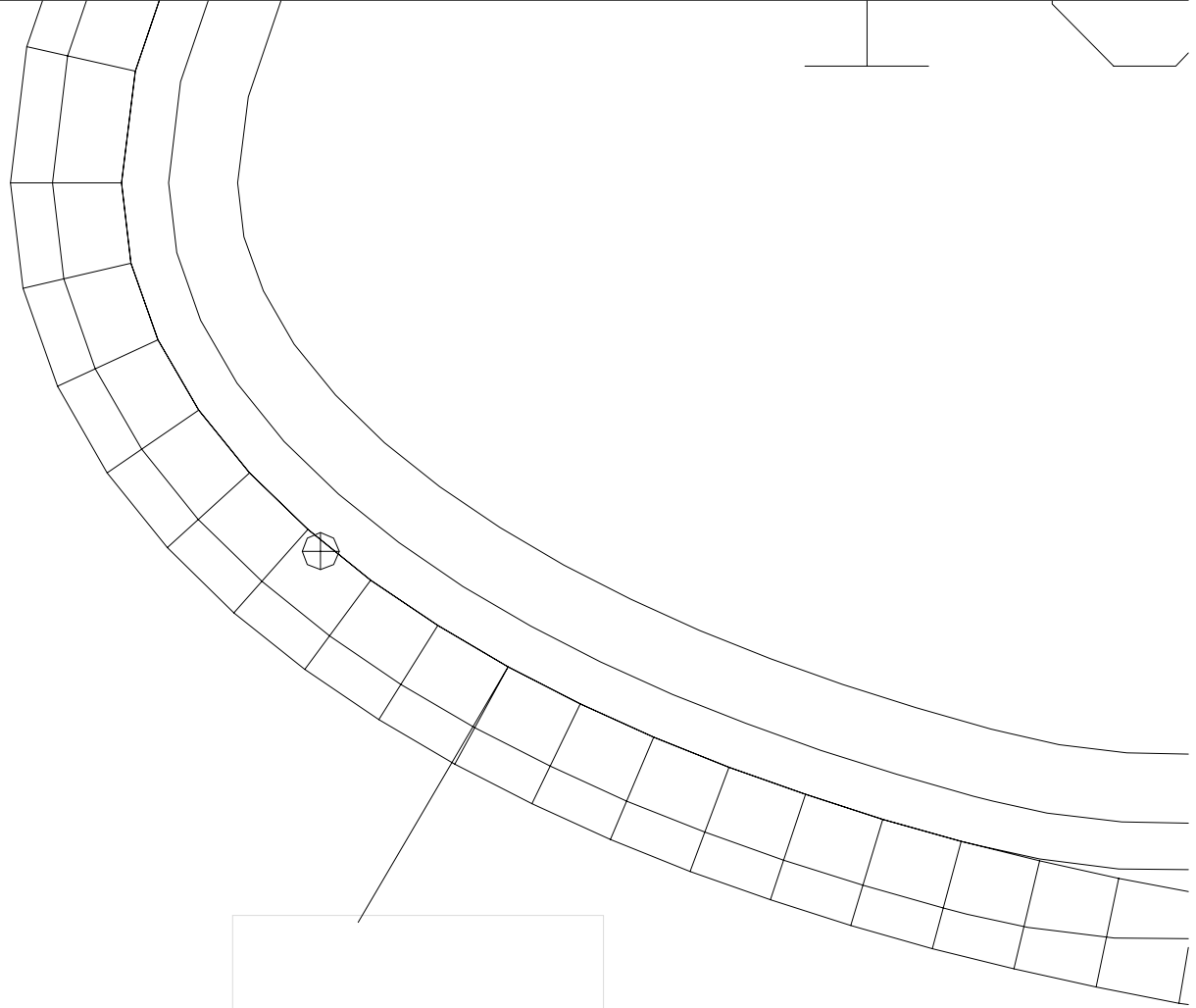

7-1

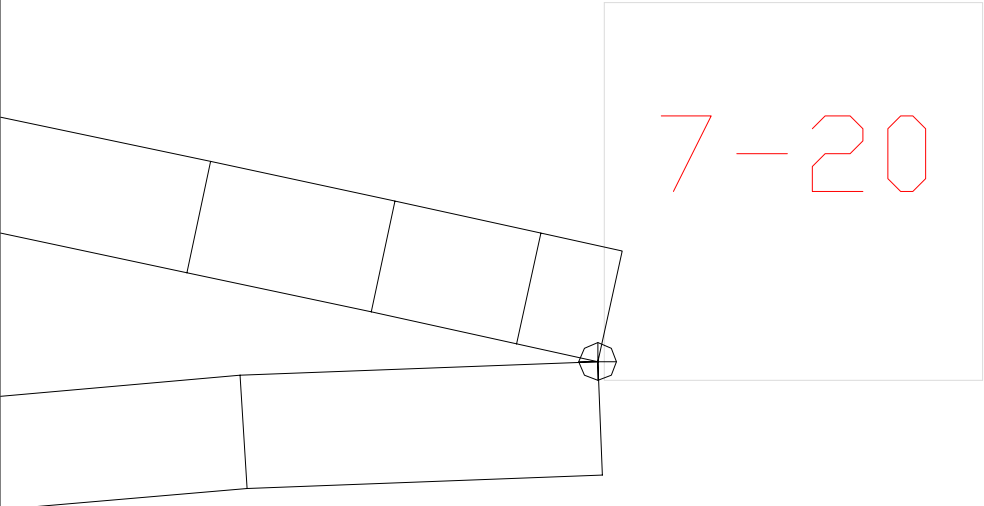

7-20

The image shows a technical drawing of a mechanical part on the left side of the page. The part consists of two main sections. The upper section is a tapered shaft-like component divided into four segments by three vertical lines. The lower section is a wider, flange-like component divided into two segments by one vertical line. A small circle with a cross inside is located at the junction of the two sections. A rectangular callout box is positioned to the right of this junction, containing the text '7-20' in red.

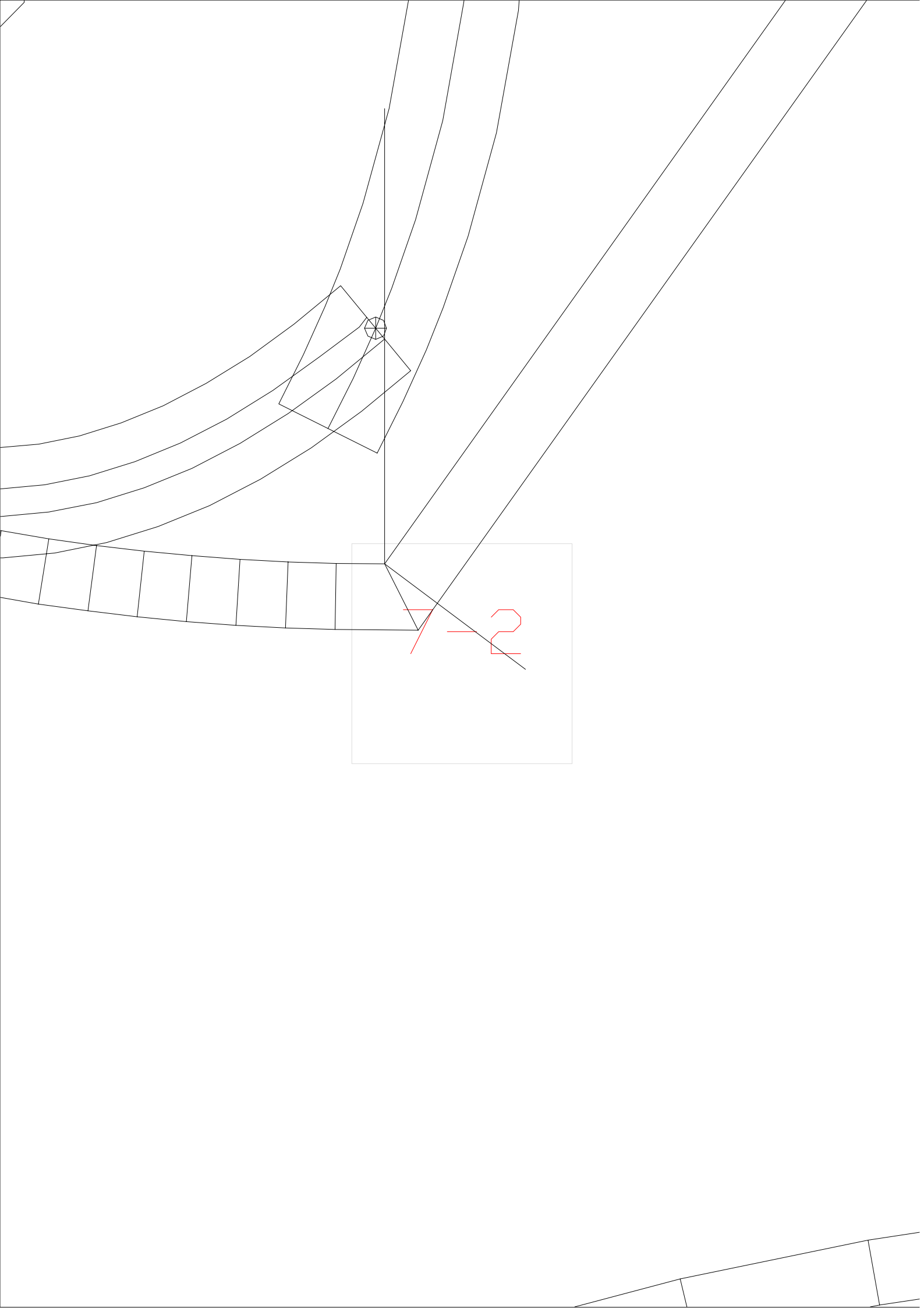

$$7 - 3$$



$$7 - 4$$



$$7 - 5$$

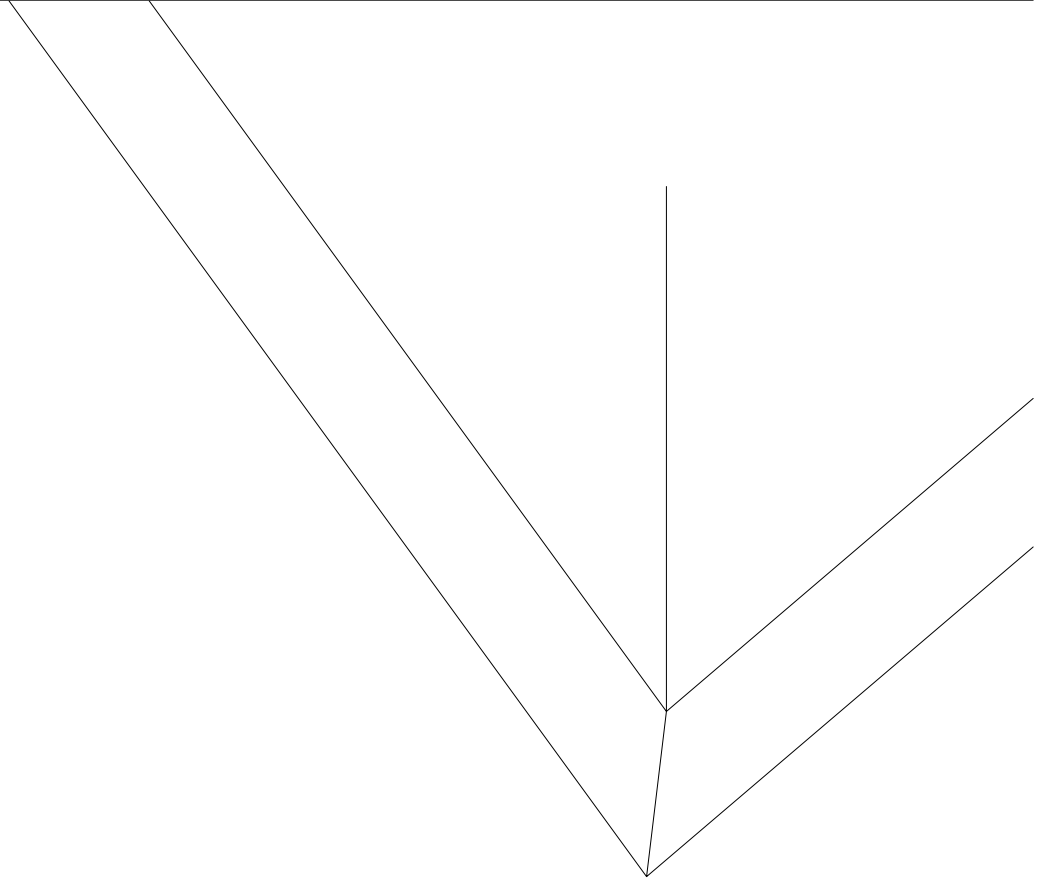

7-6

 $7-7$

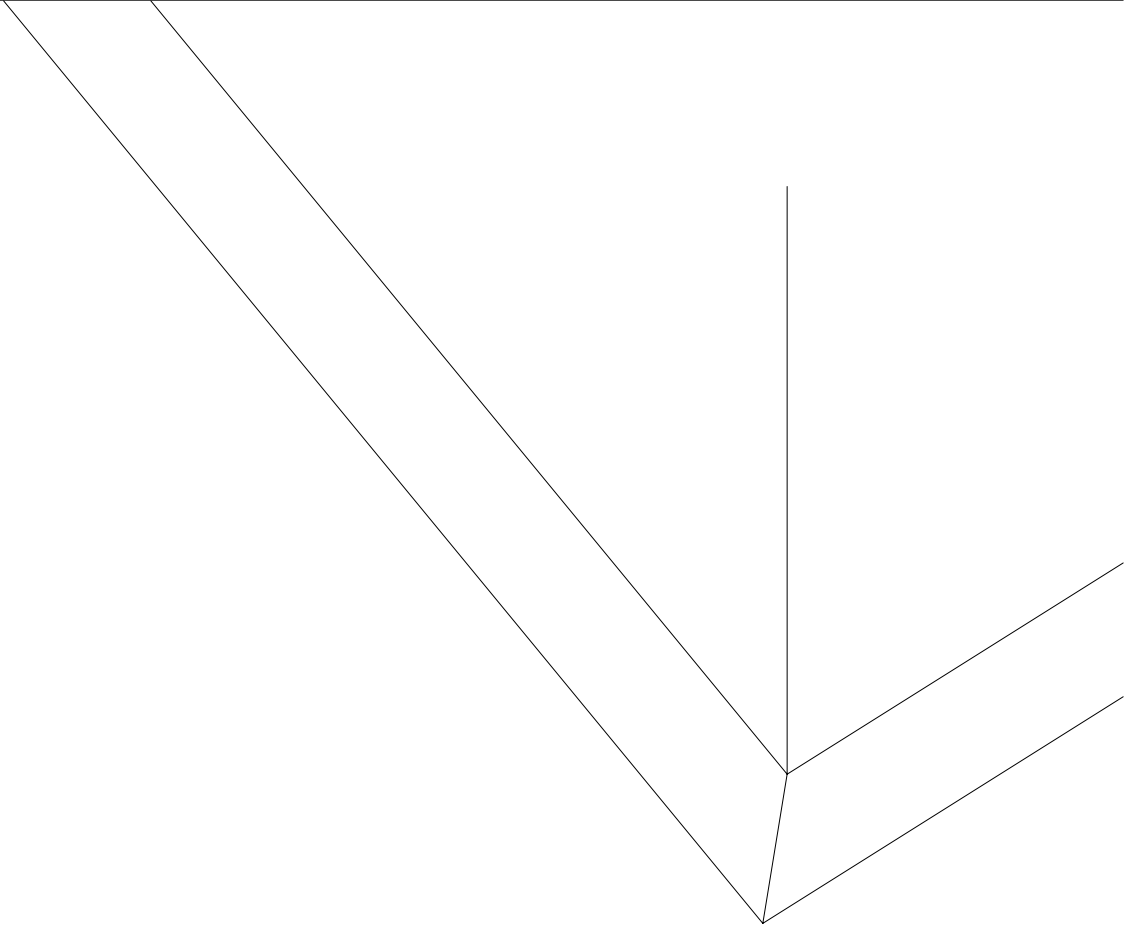

$$7 - 8$$

7-9

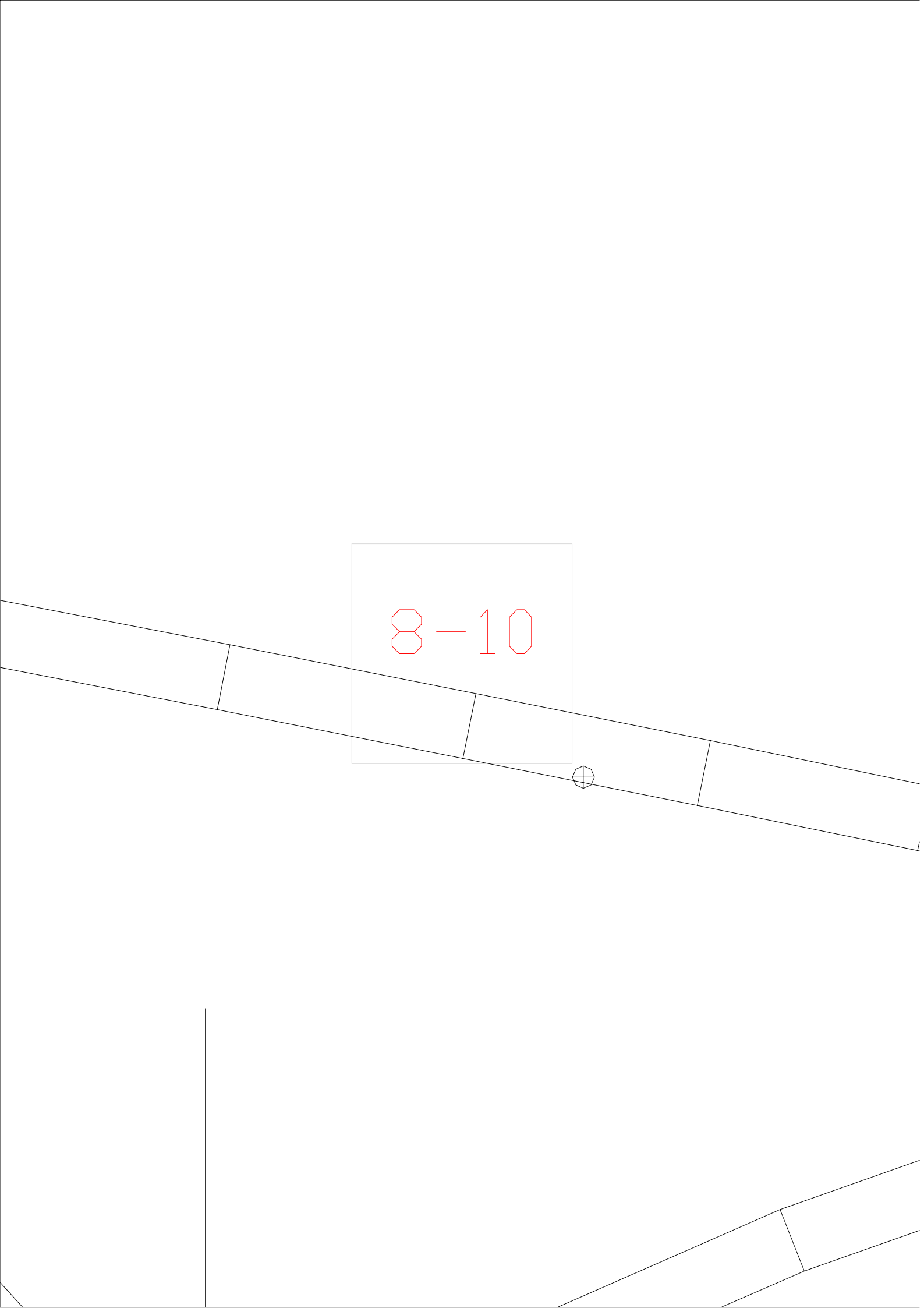

8-10

The image shows a technical drawing of a tapered shaft. The shaft is represented by two parallel lines that converge from left to right. A section line, consisting of a solid line and a dashed line, is drawn across the shaft. A callout box, outlined in light gray, is positioned above the shaft and contains the text "8-10" in red. The shaft is divided into several segments by vertical lines. A small circle with a cross inside is located on the lower surface of the shaft, to the right of the callout box. The drawing is set against a white background with a vertical line on the left and a horizontal line at the bottom.

8-11

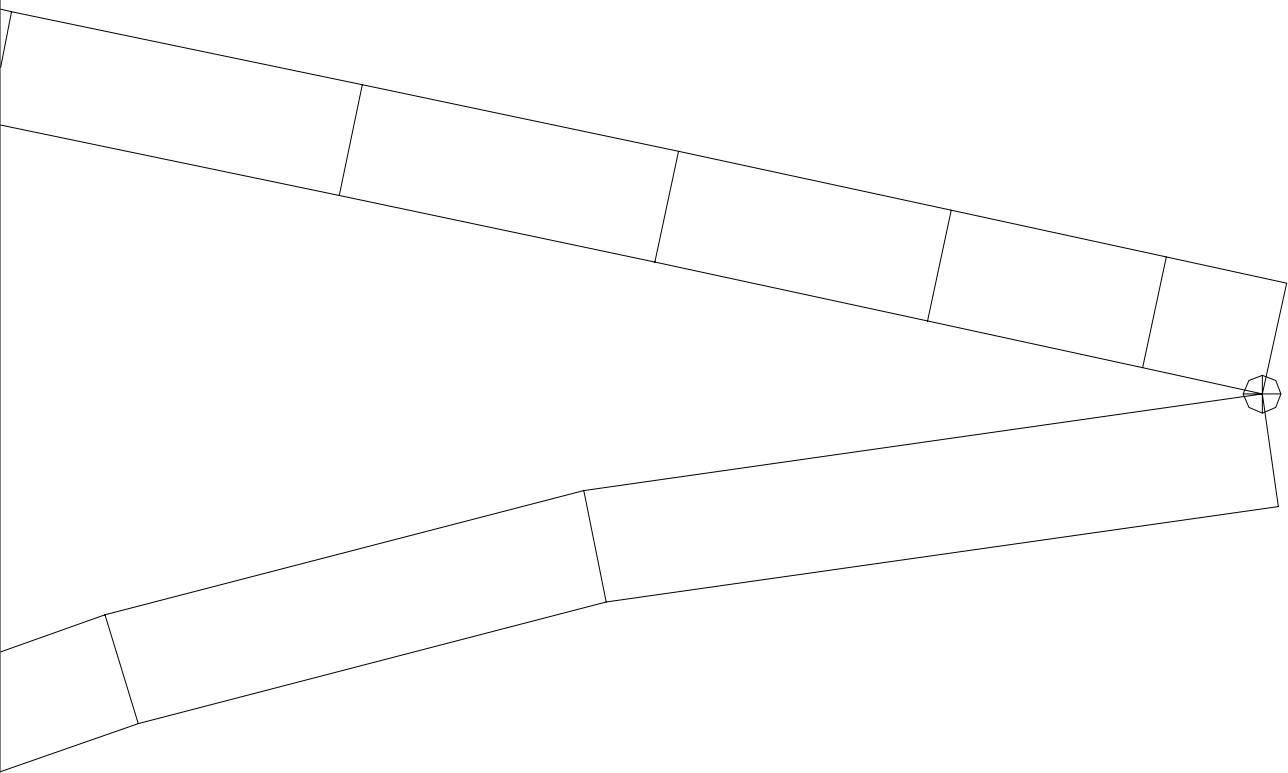

8-12

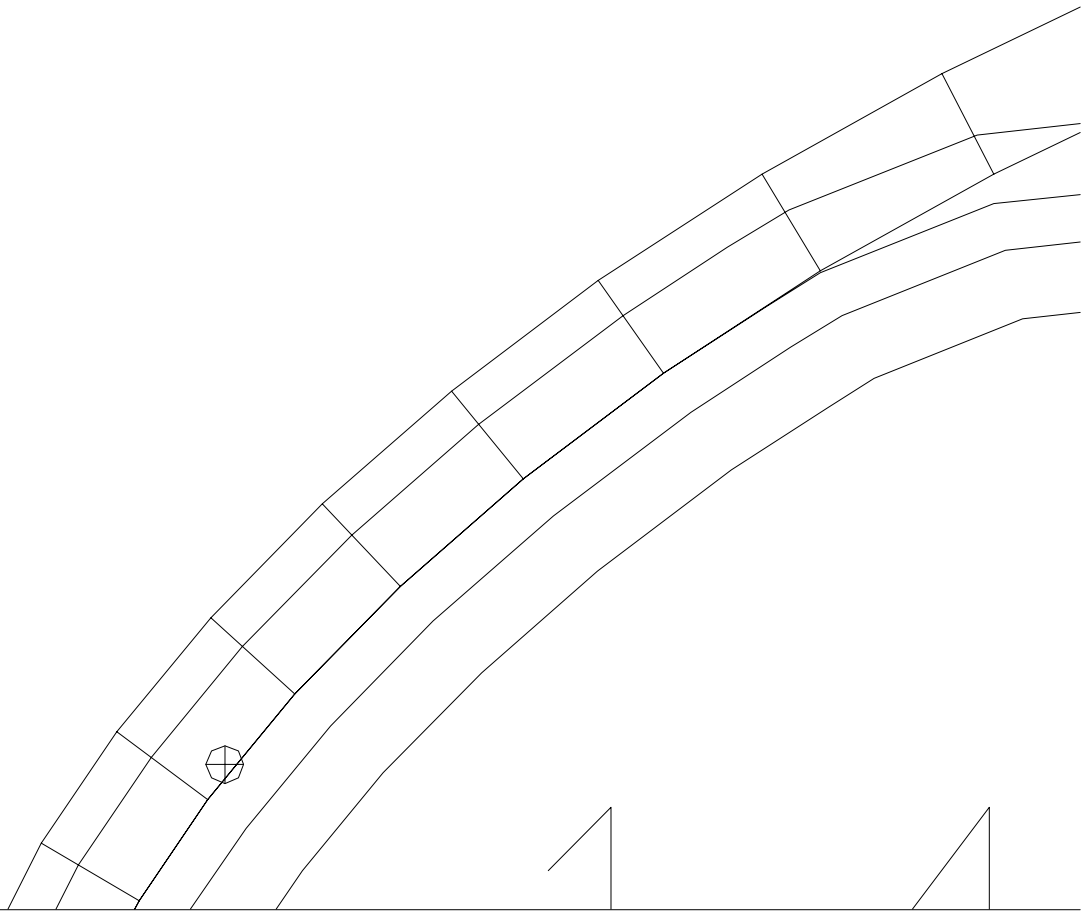

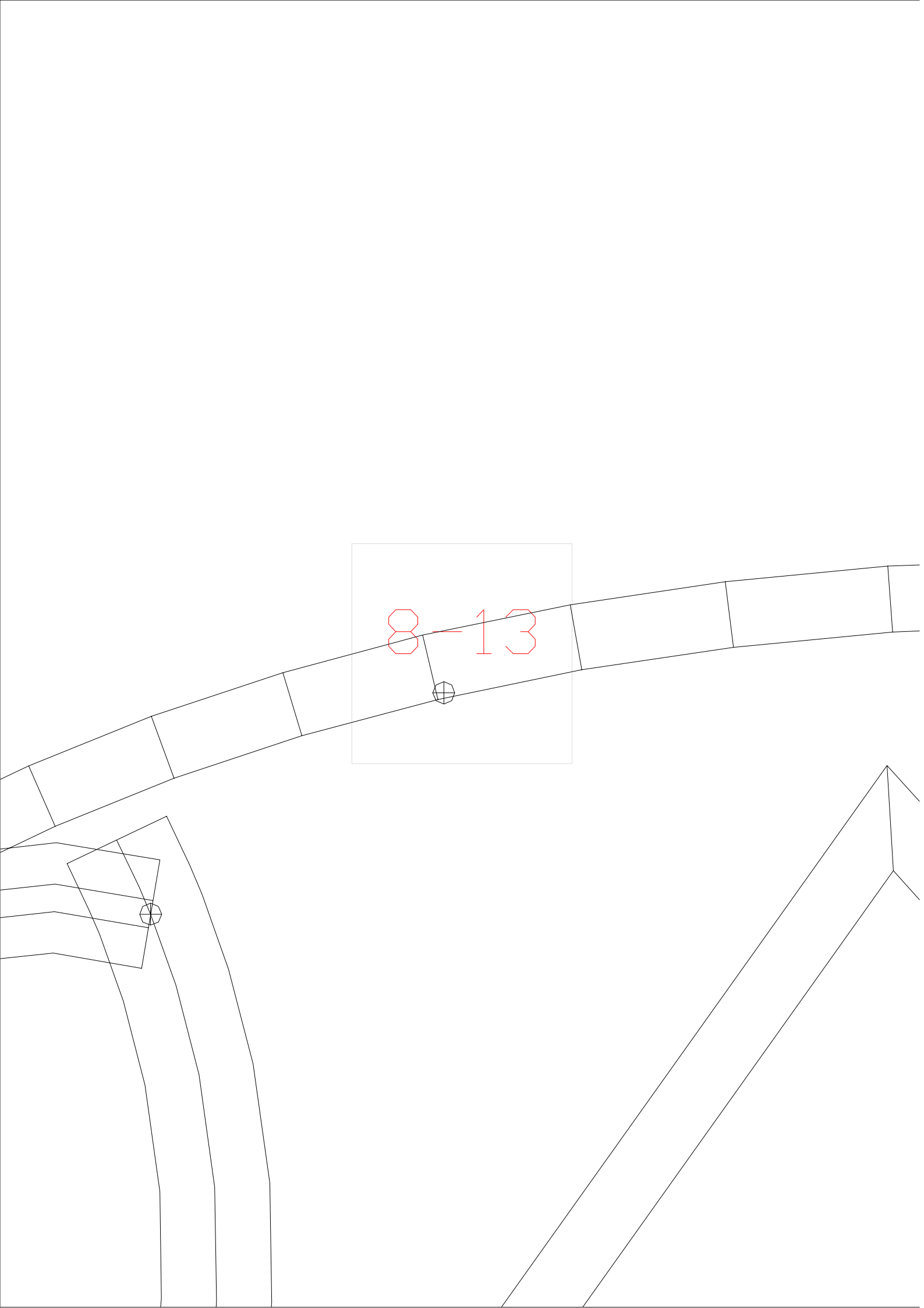

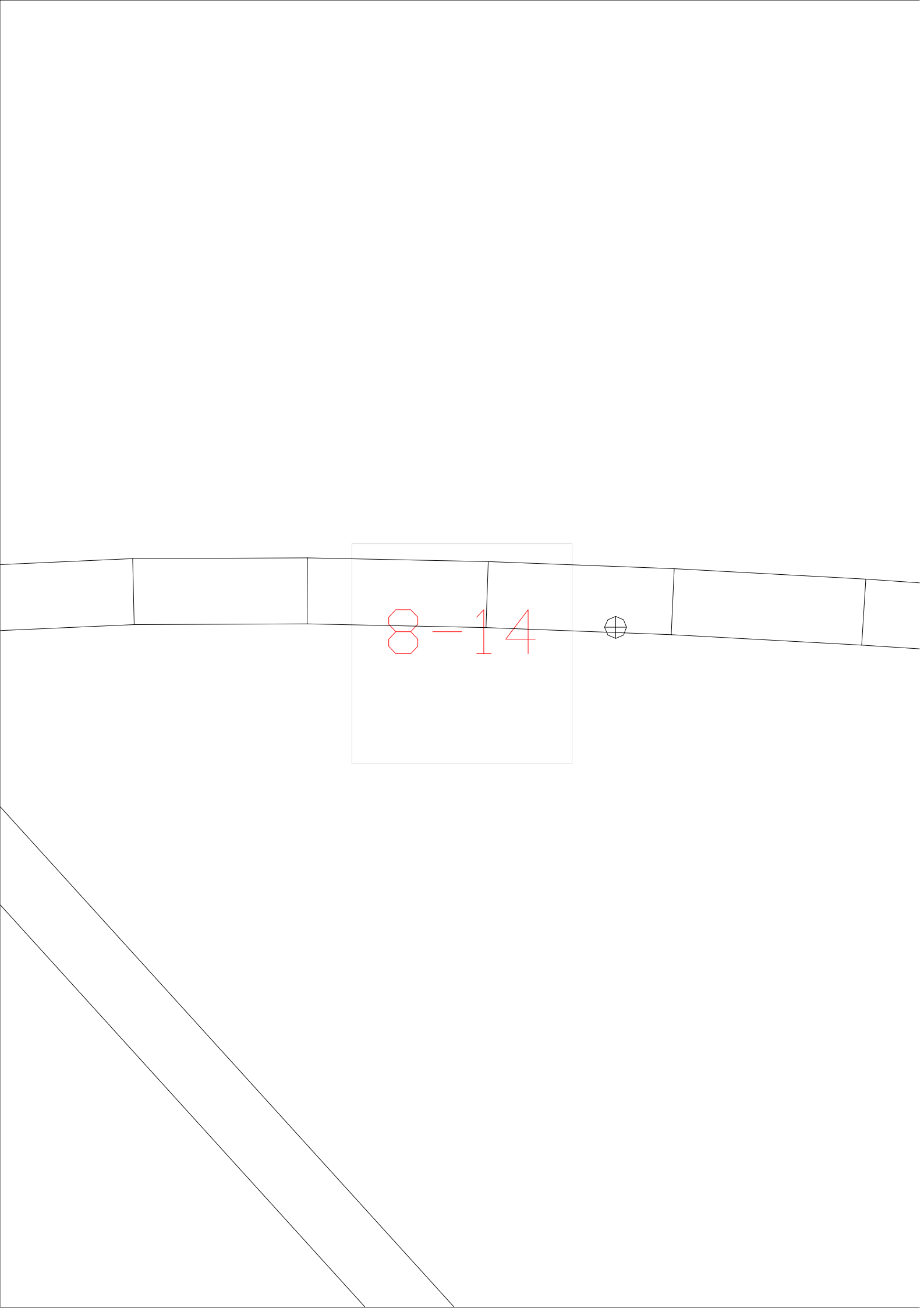

8-14



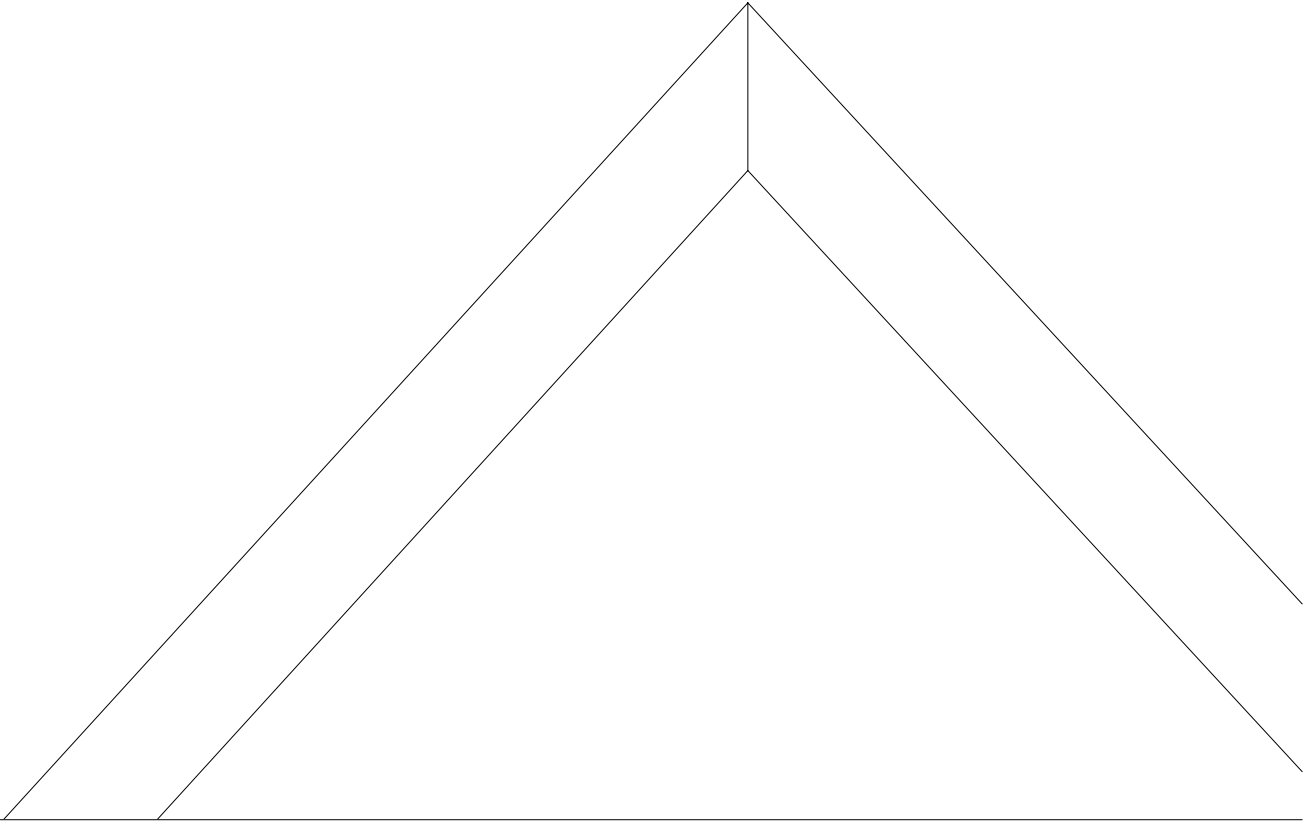
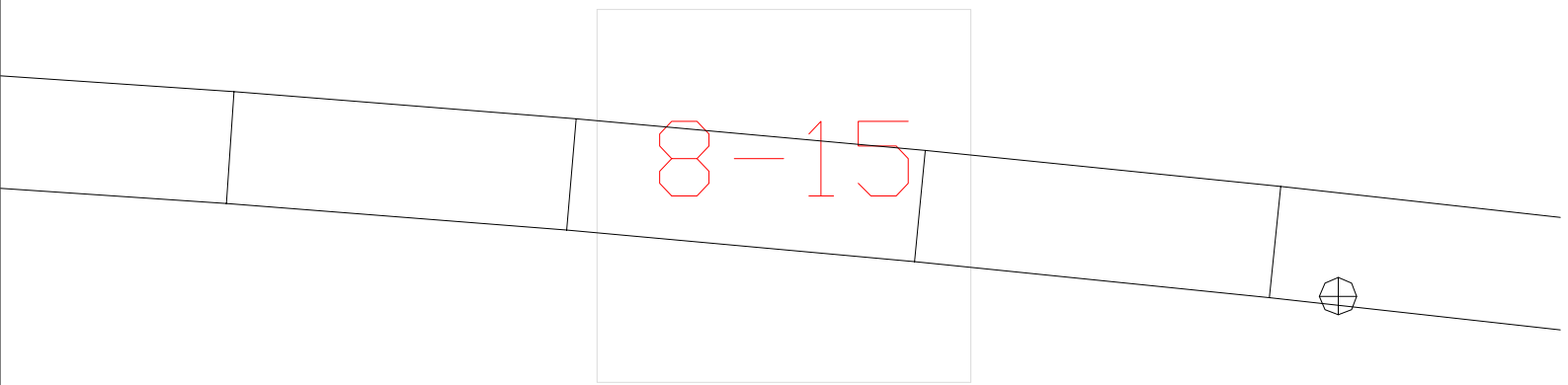

8-16

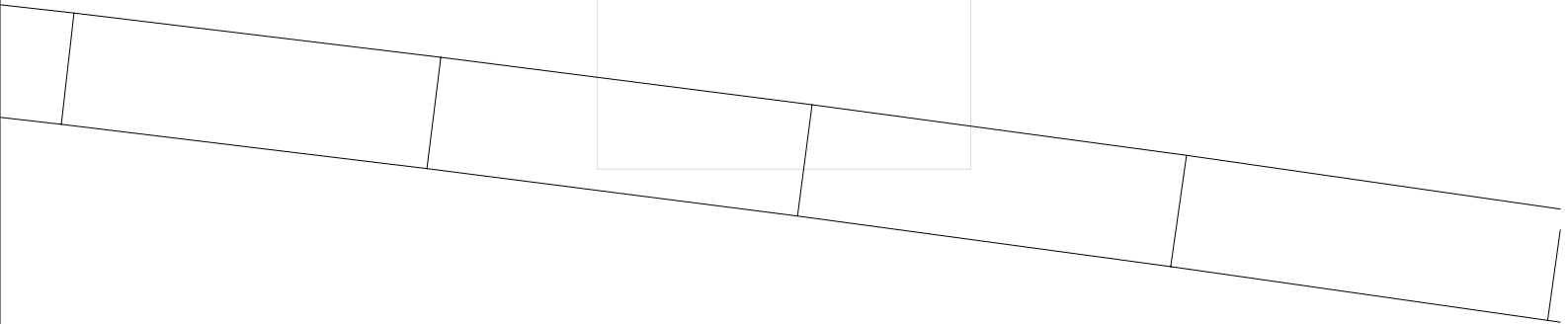

8-17

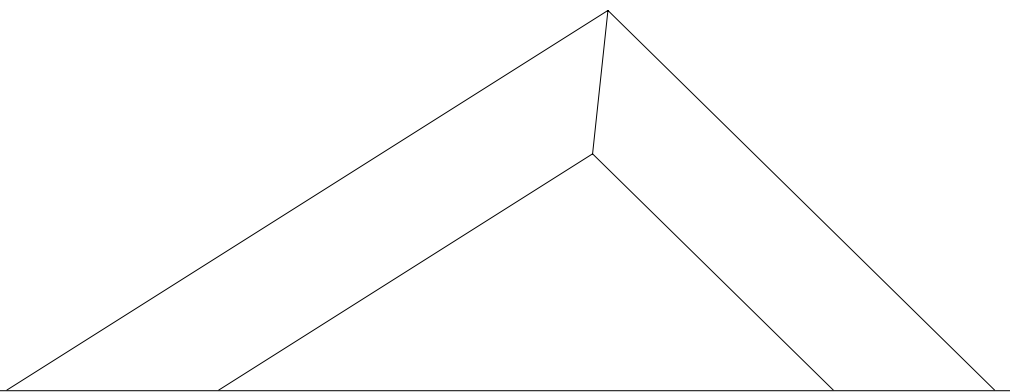
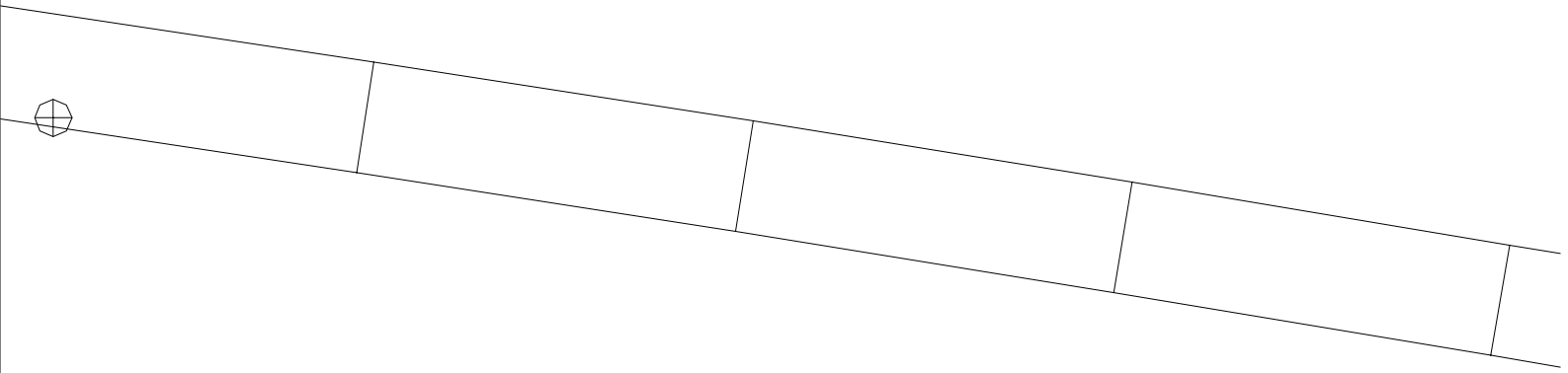

8-18



8-19

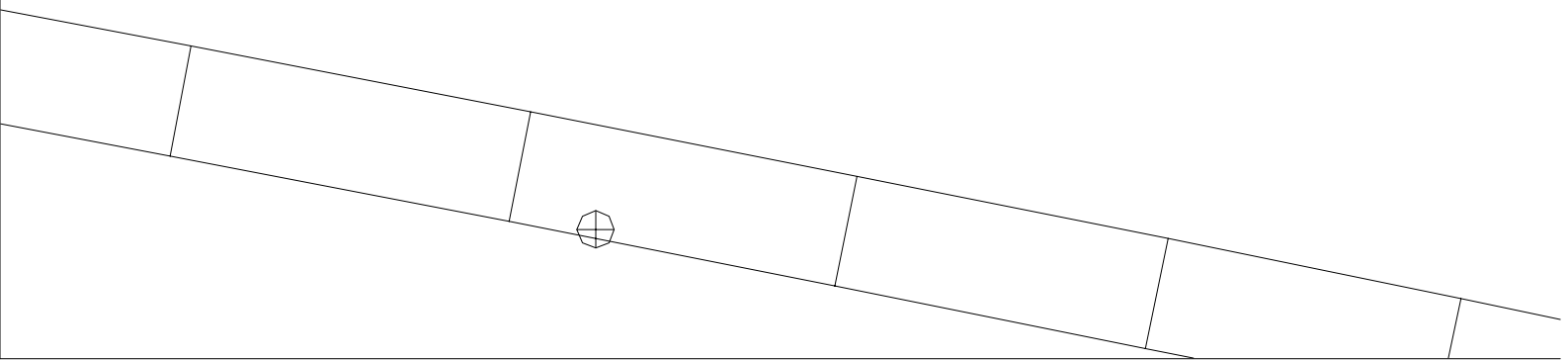

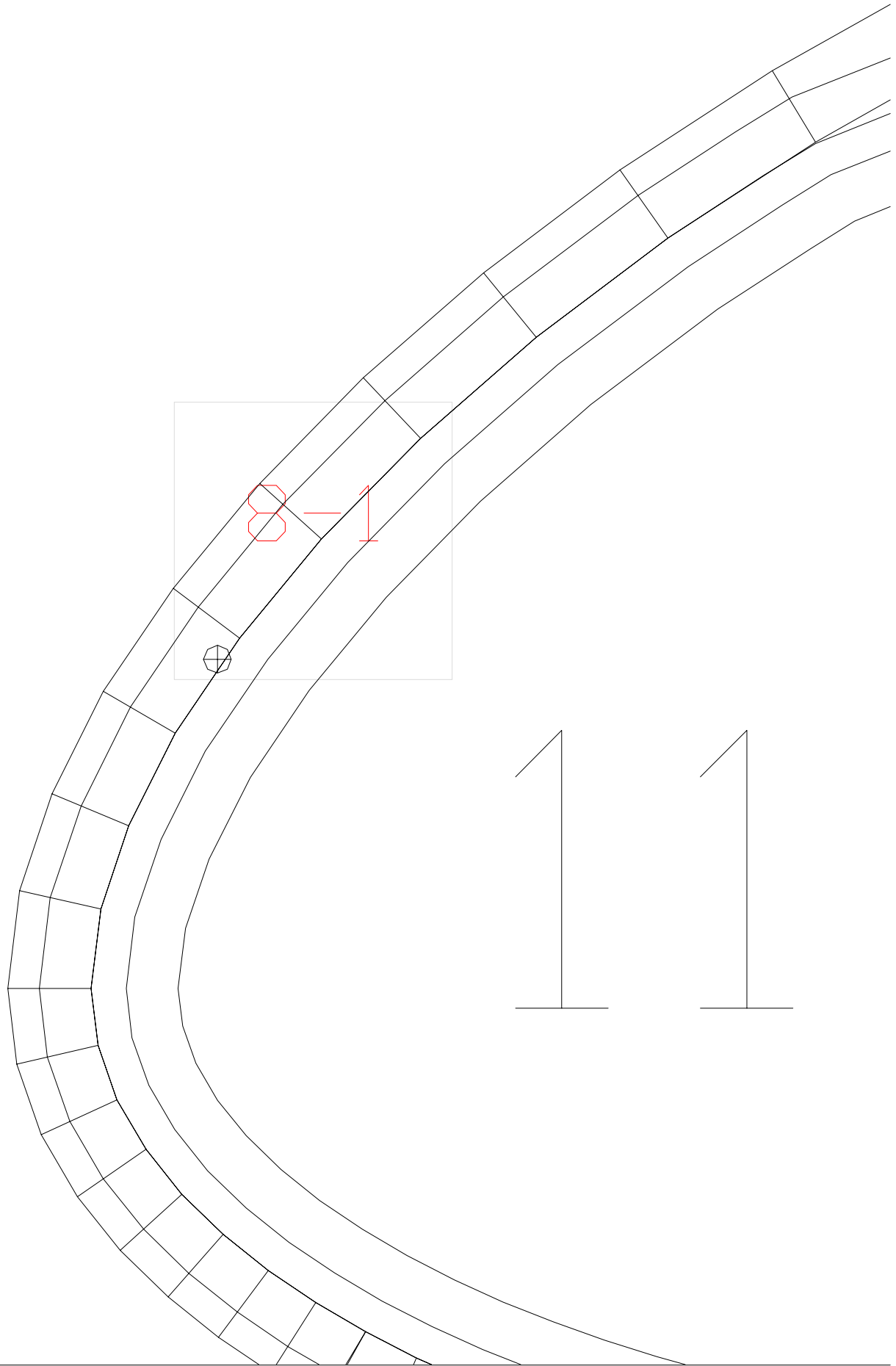

8-20

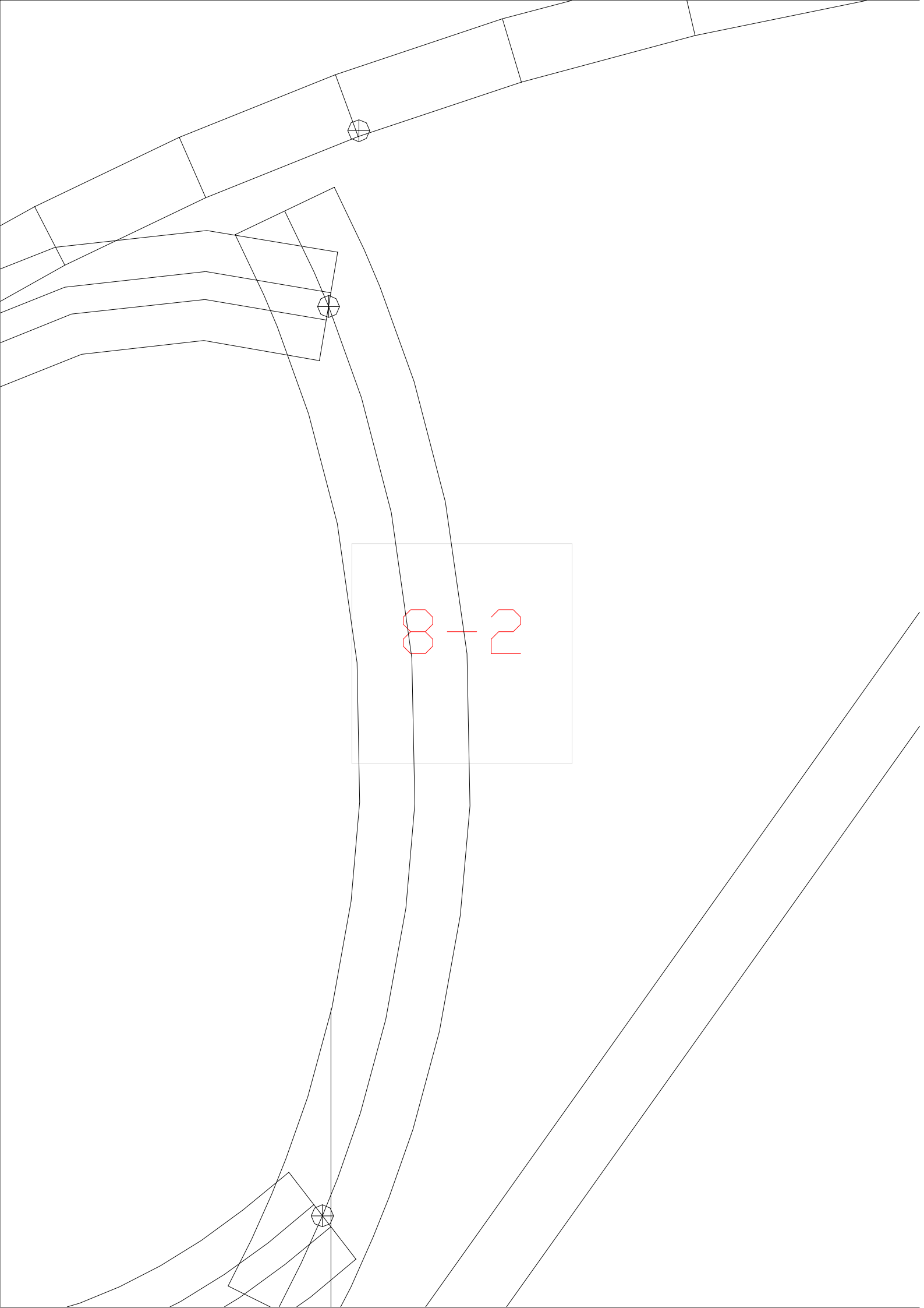

8-2

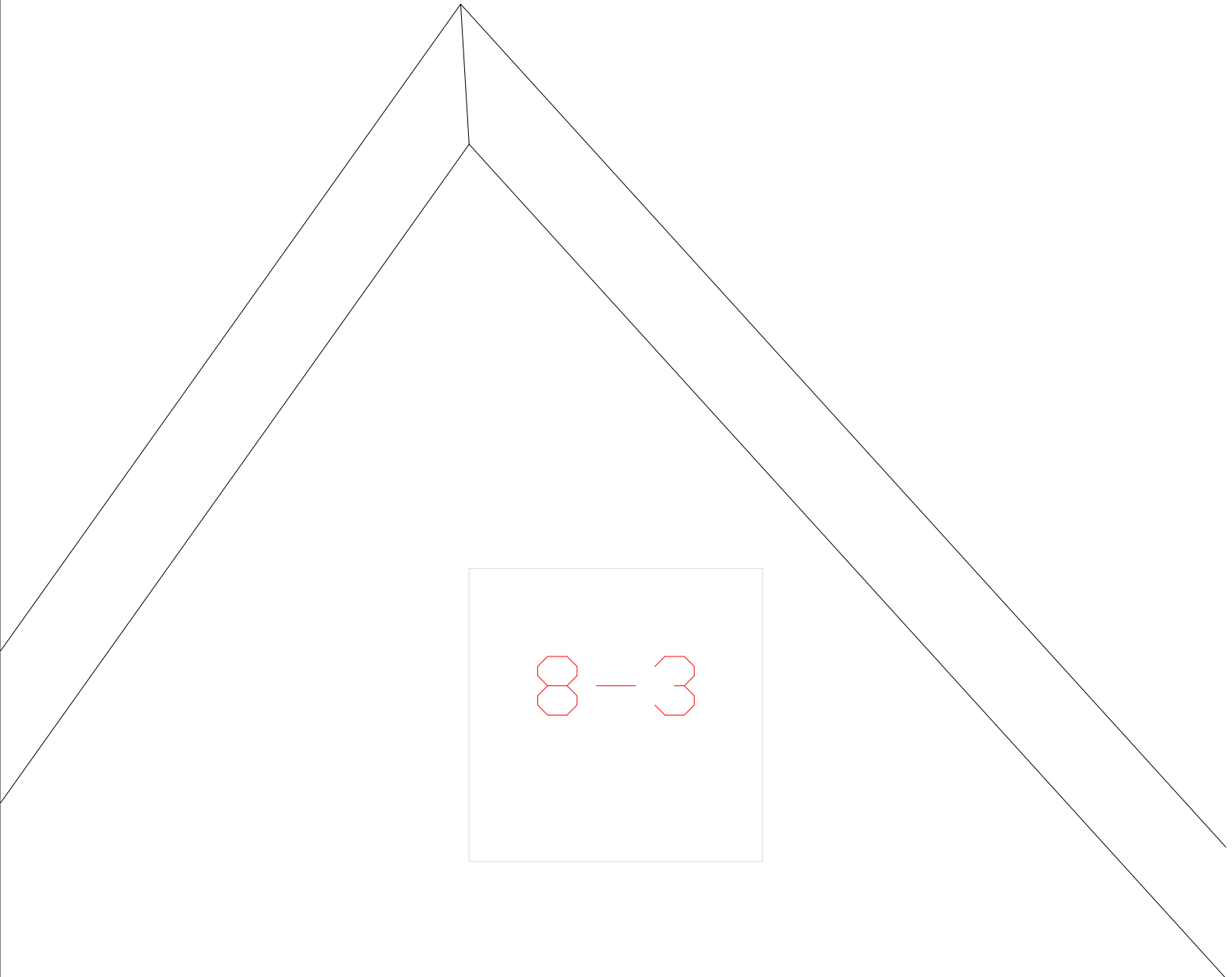

8-3

$$8 - 4$$



8-5

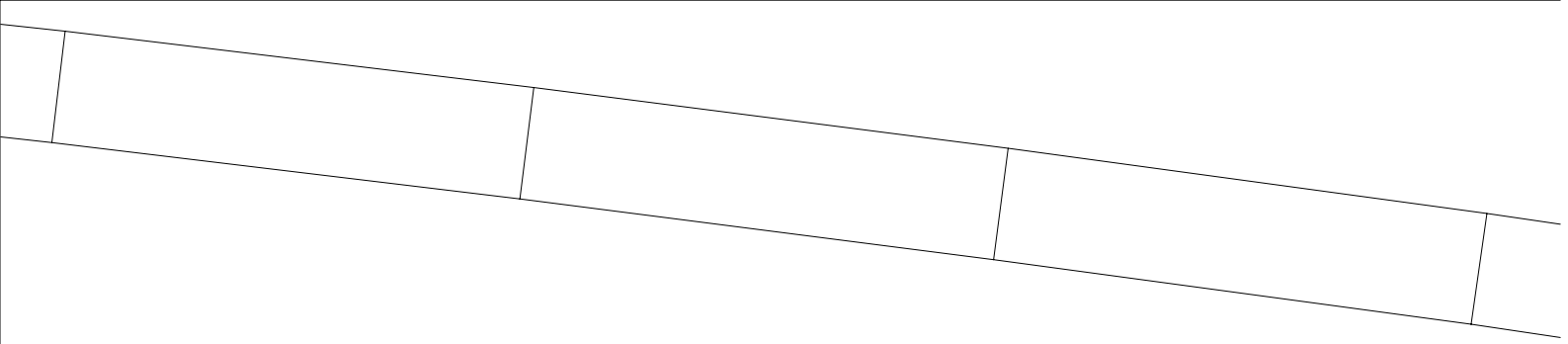

8-6

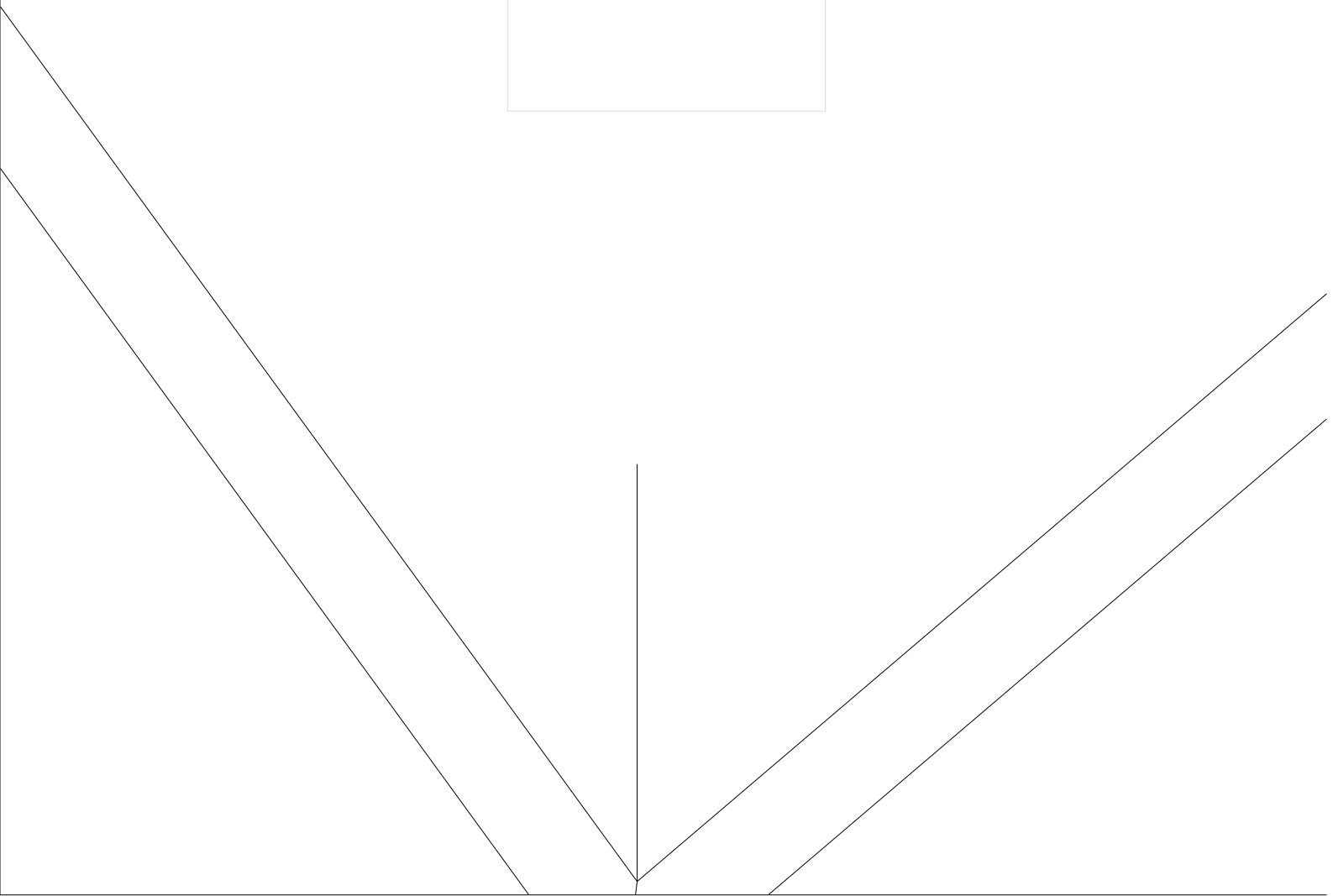

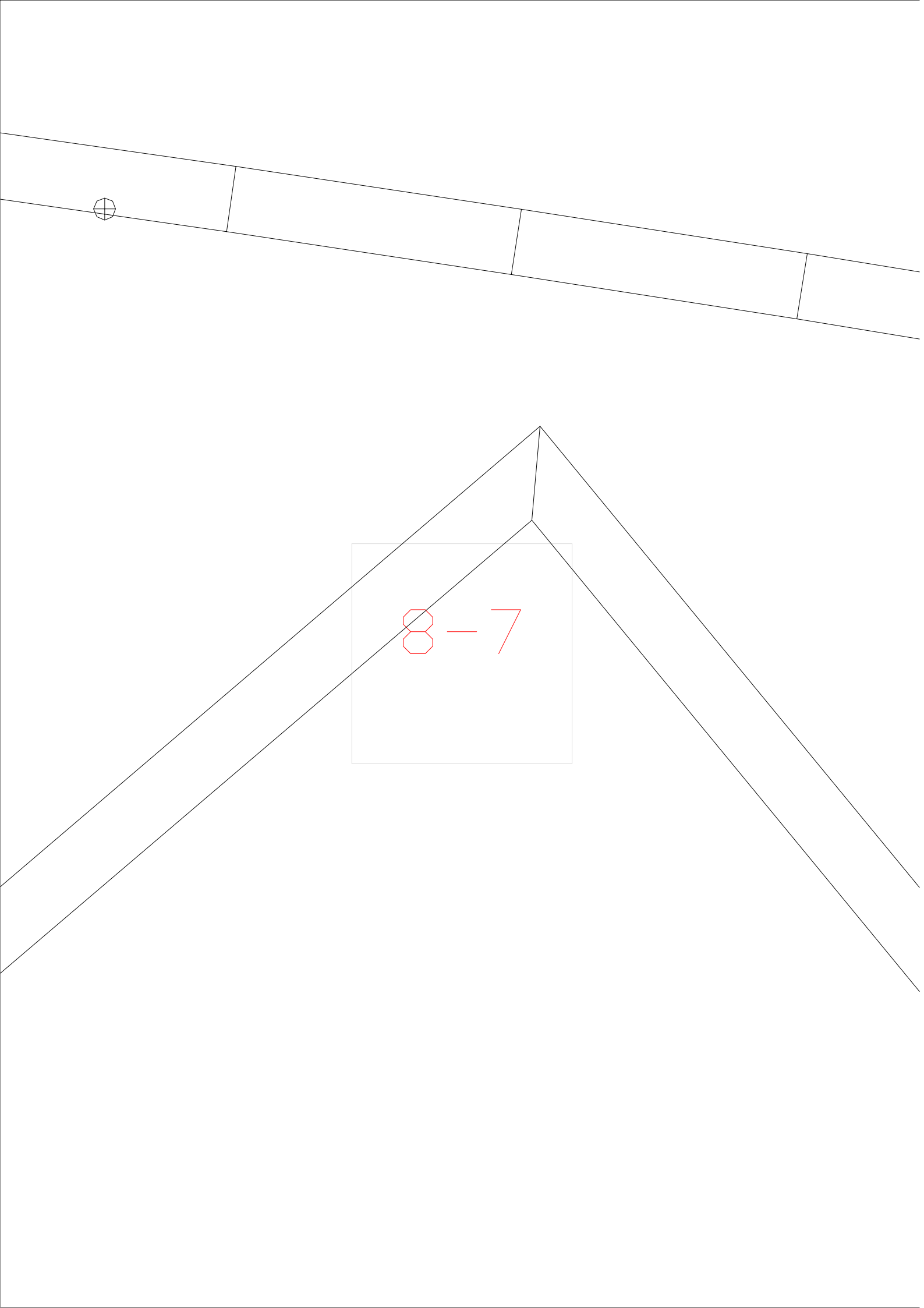

8-7

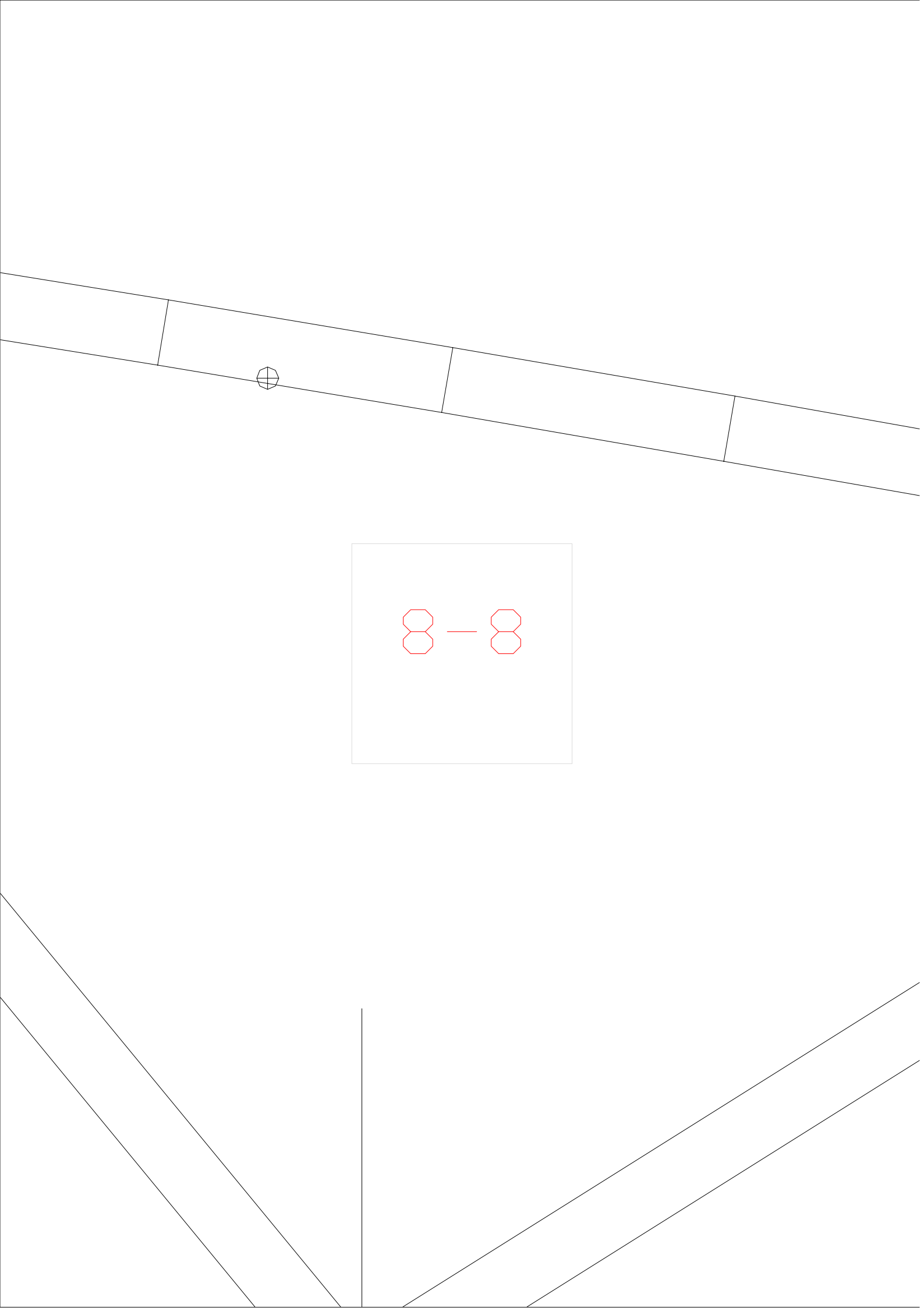

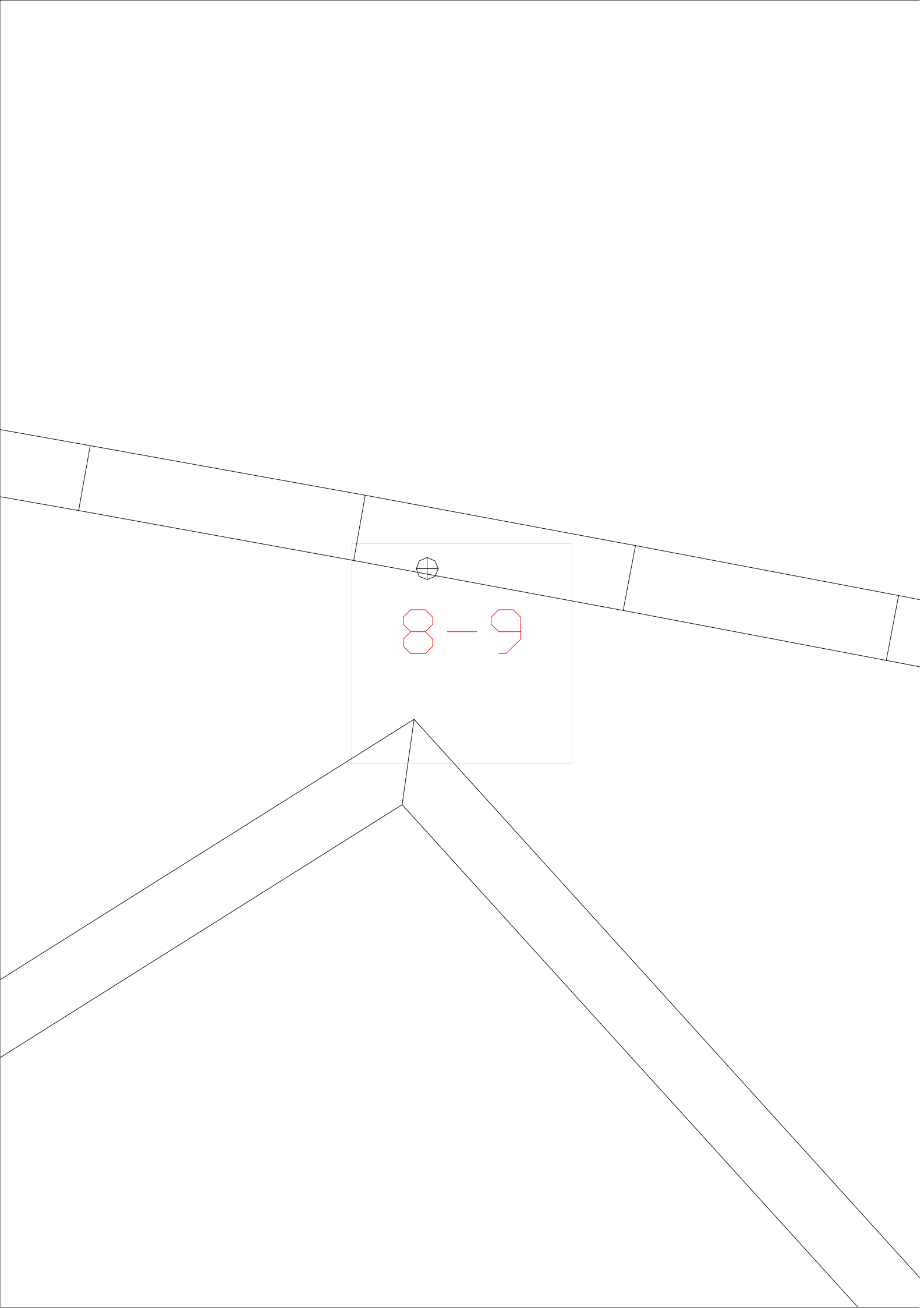

8-9

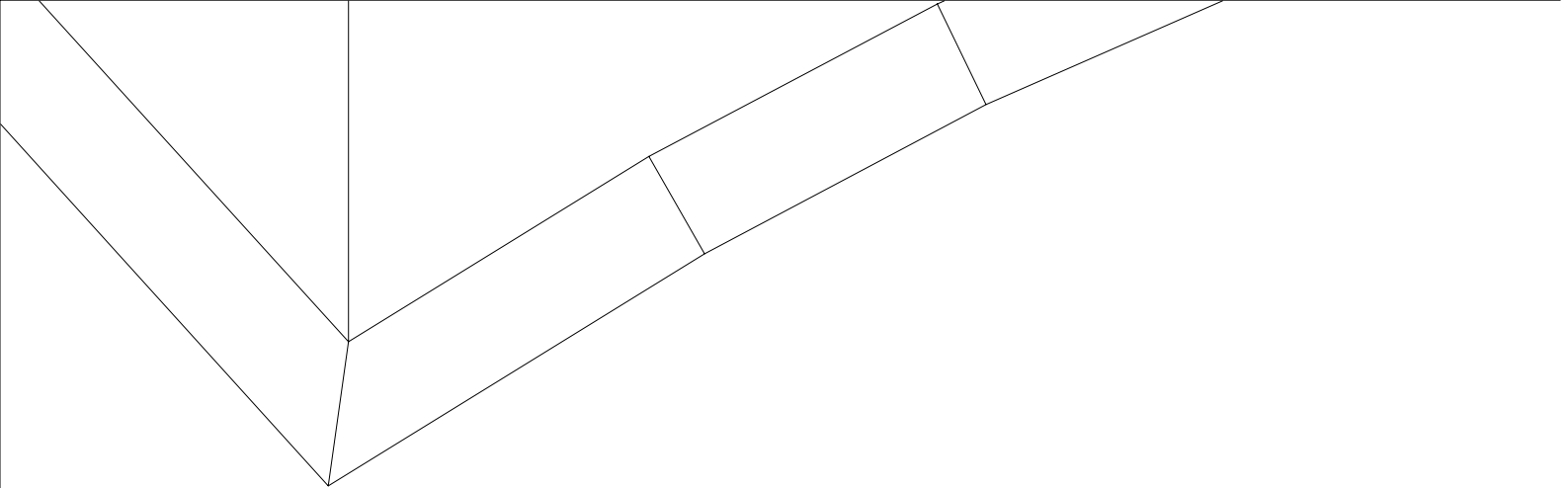

9-10

9-11

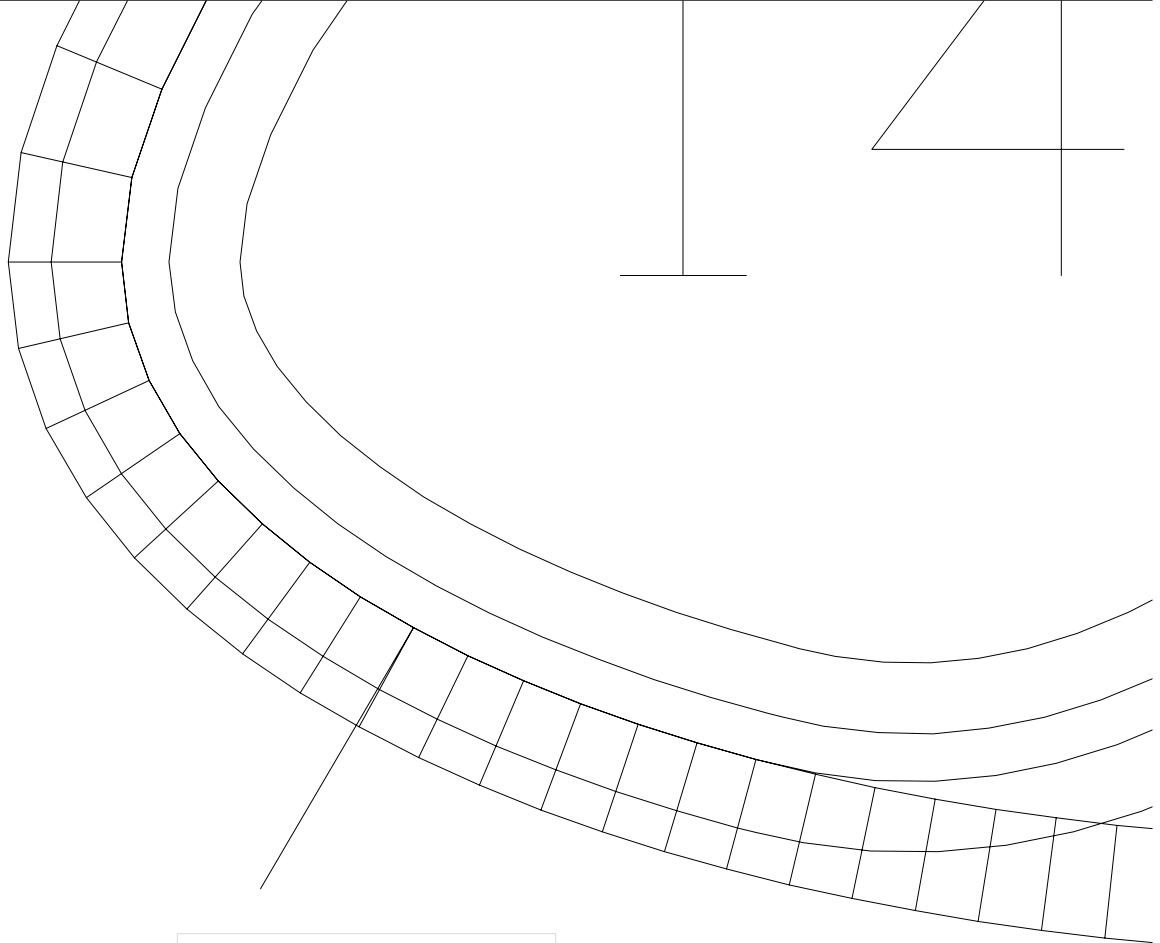

9-12

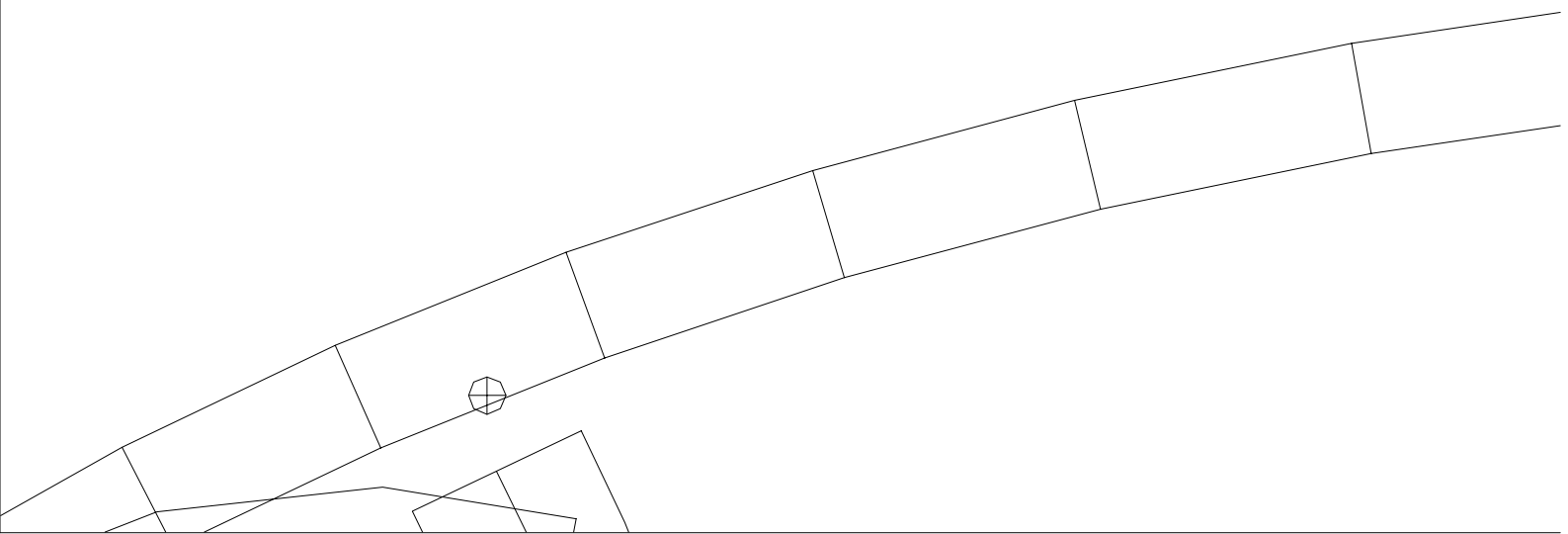

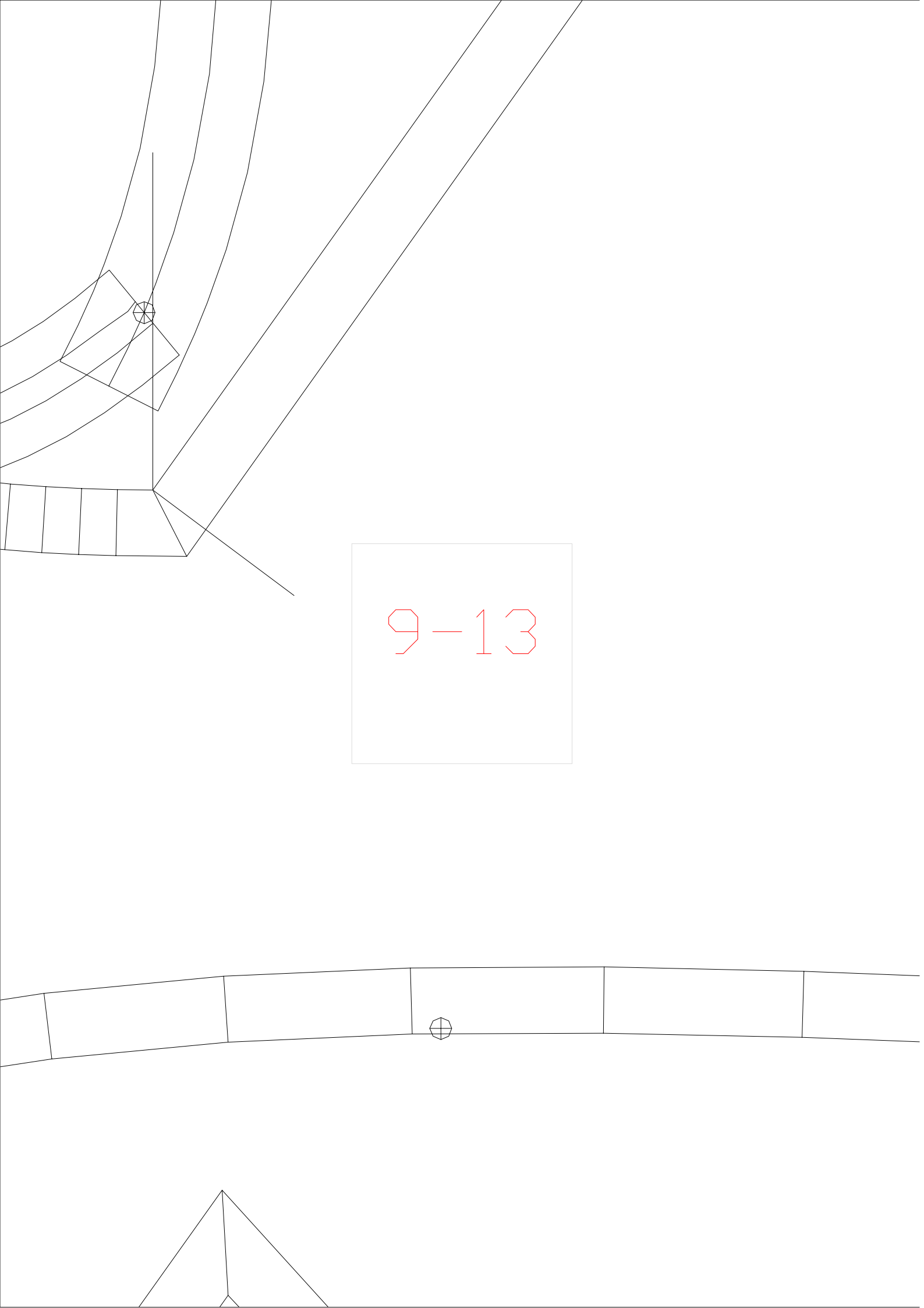

9-13

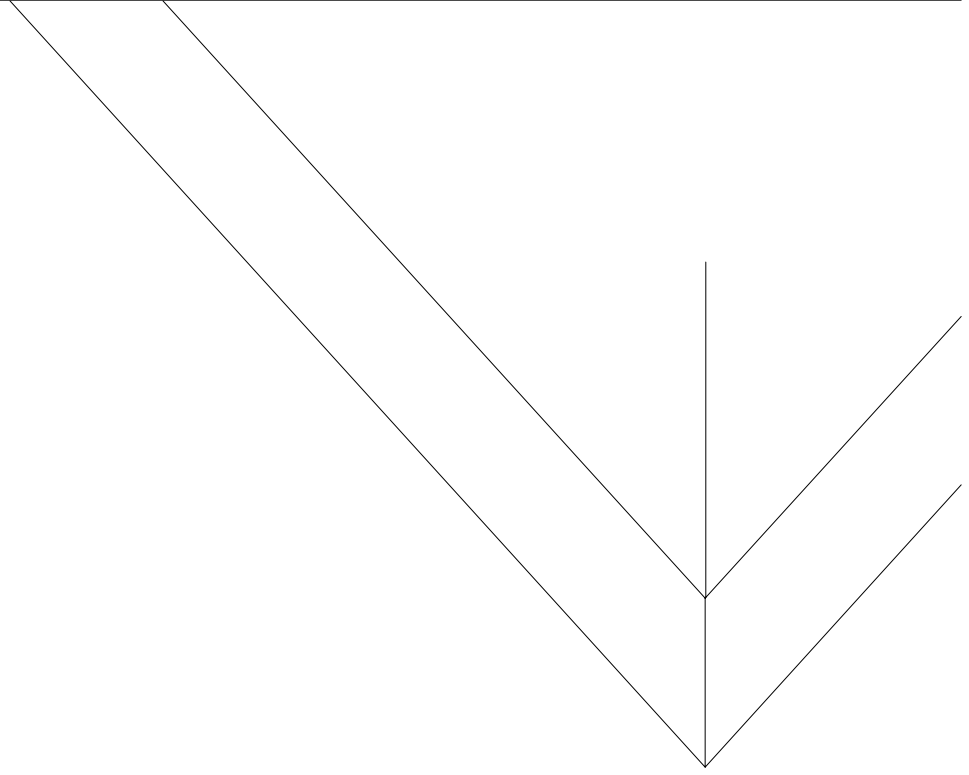

9-14

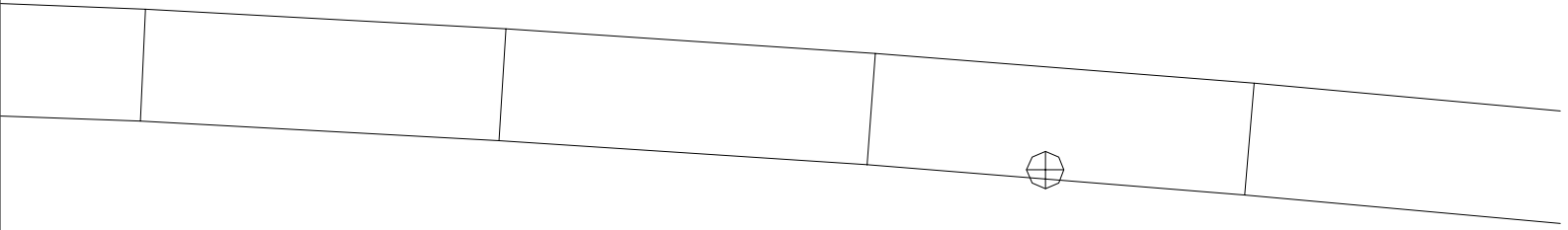

9-15

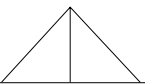

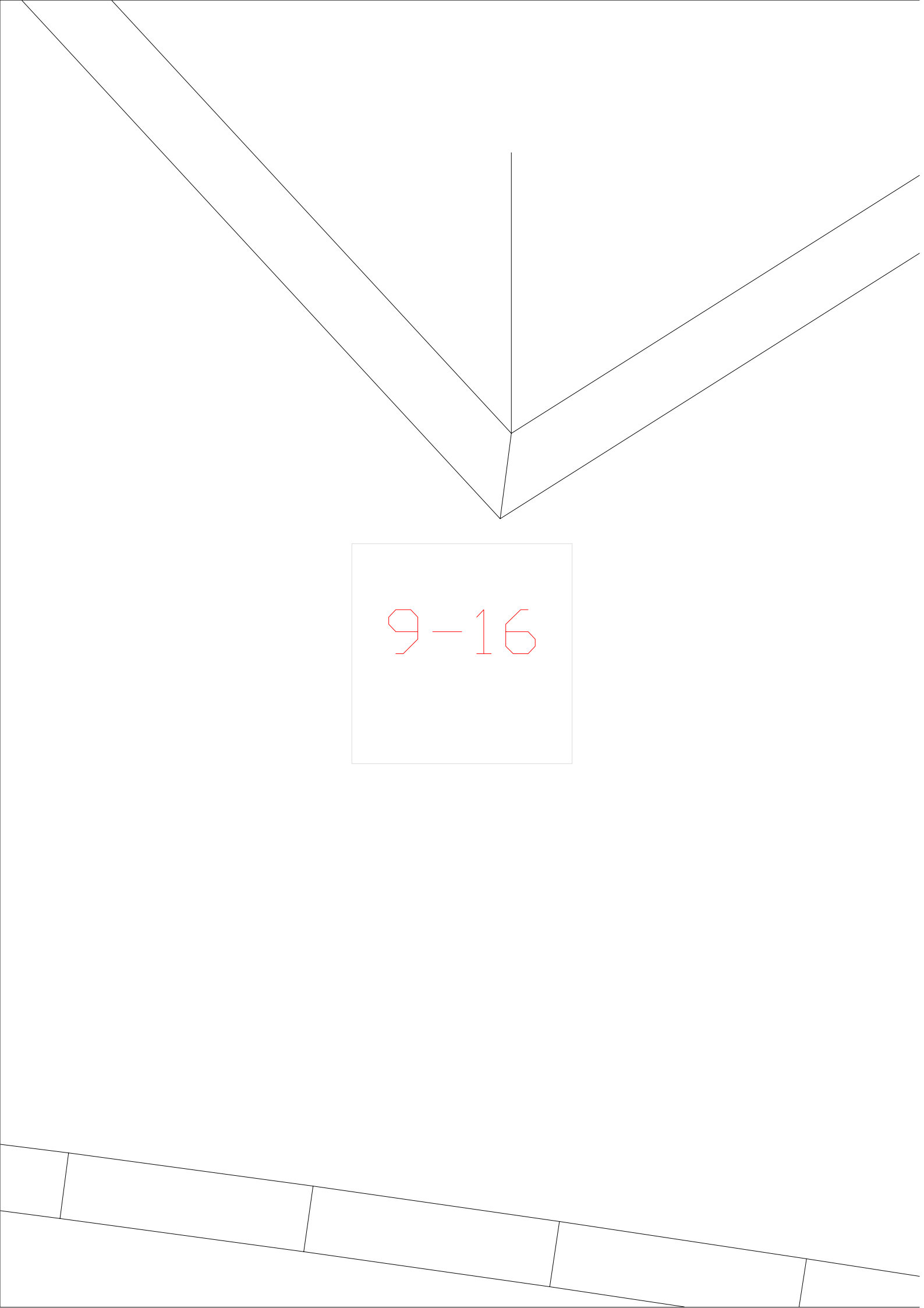

9-16

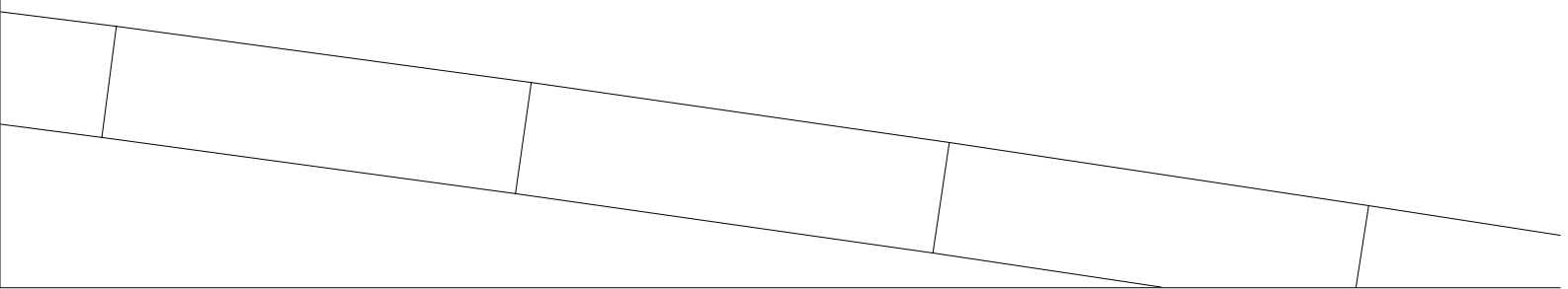

9-17

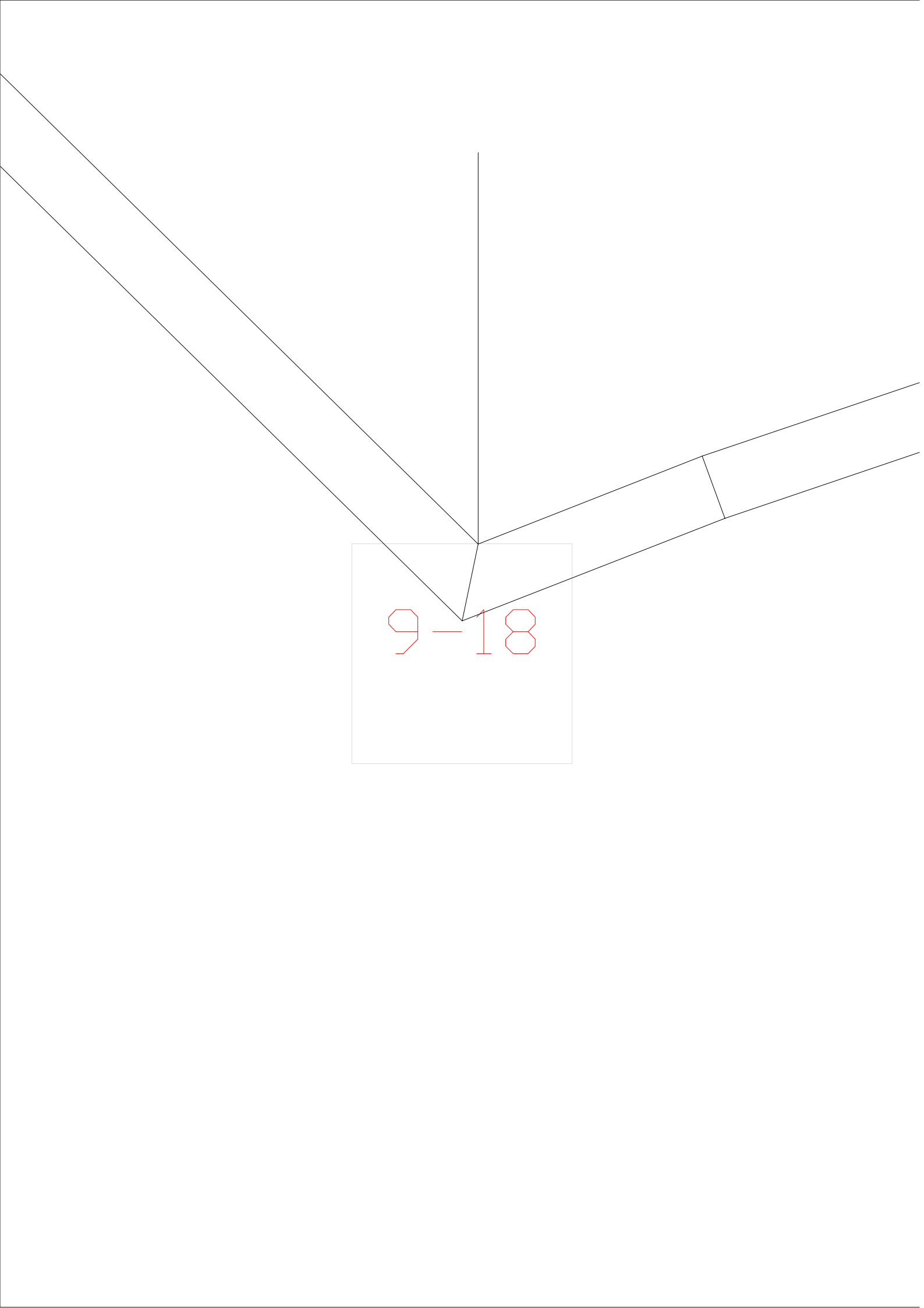

9-18

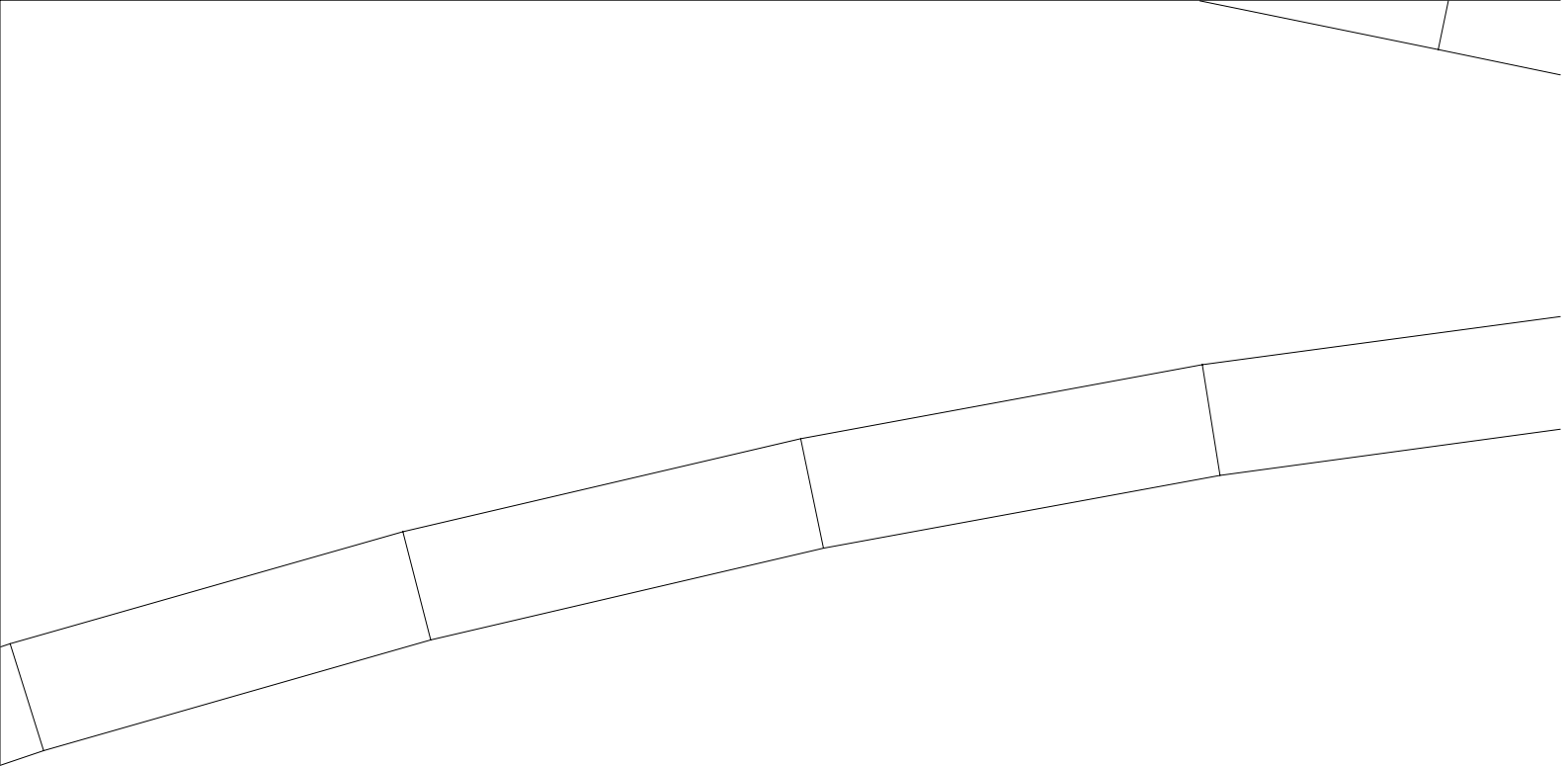

9-19

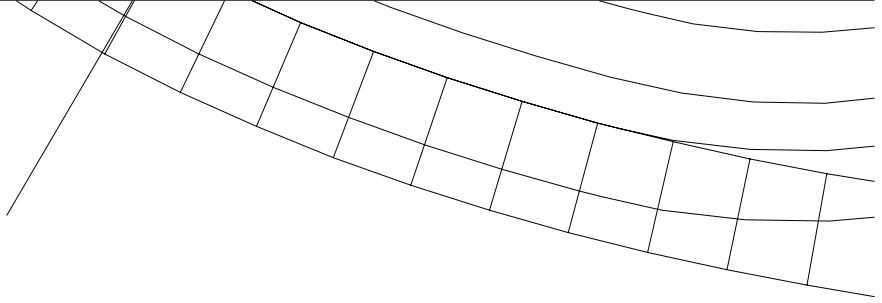

9-1

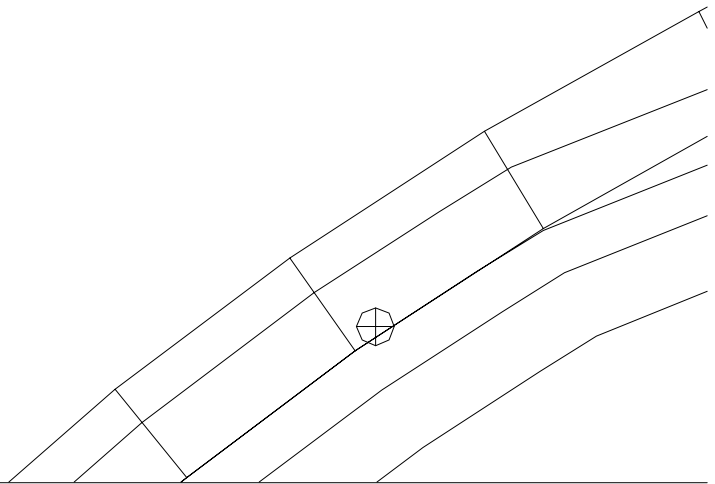

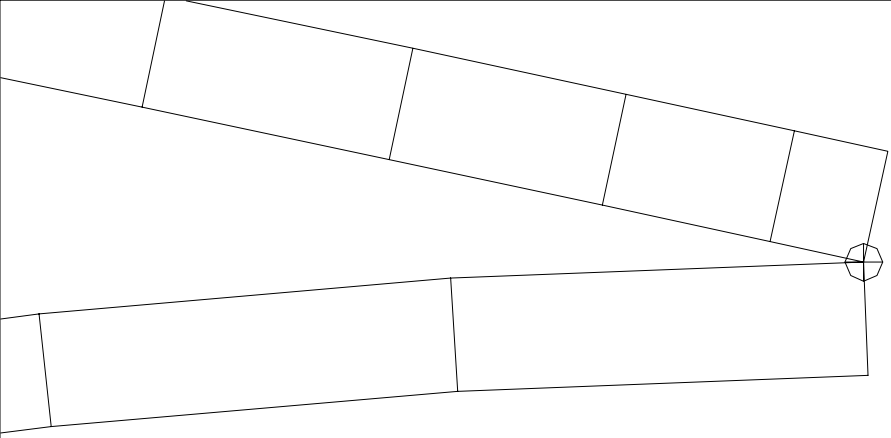

9-20

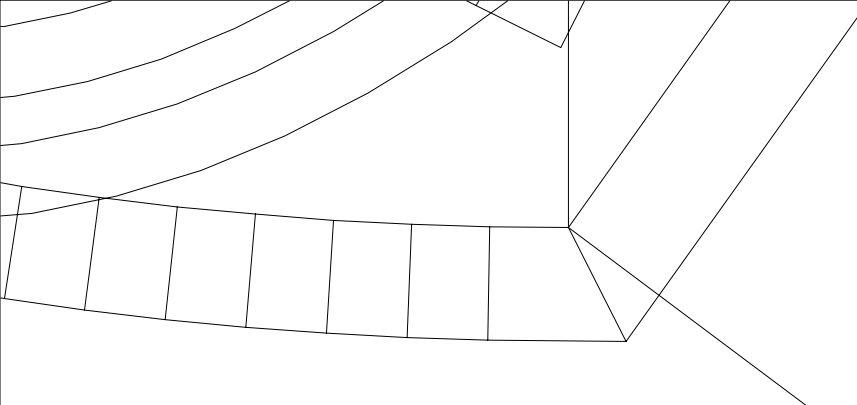

9-2

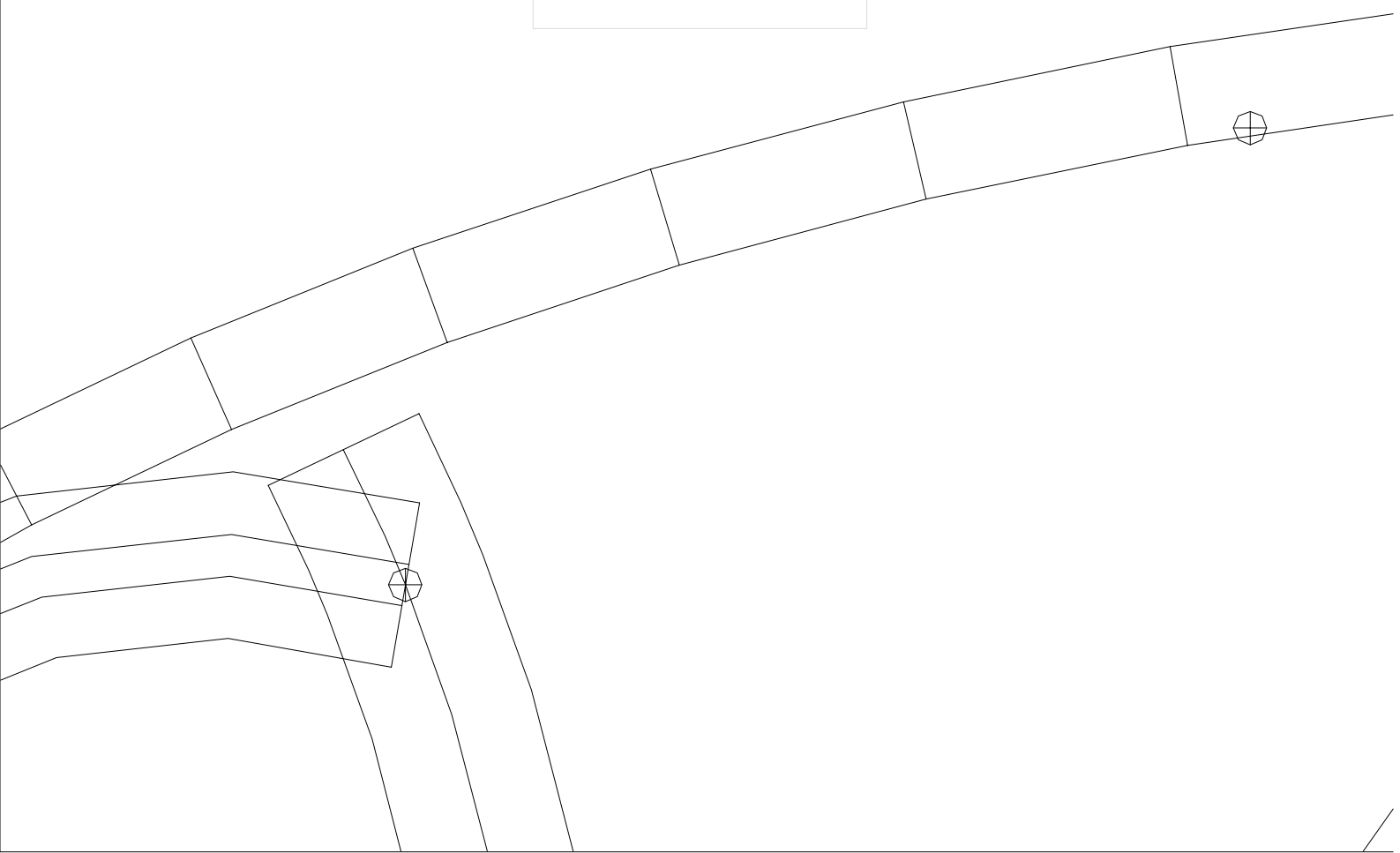

$$9 - 3$$

9-4



9-5

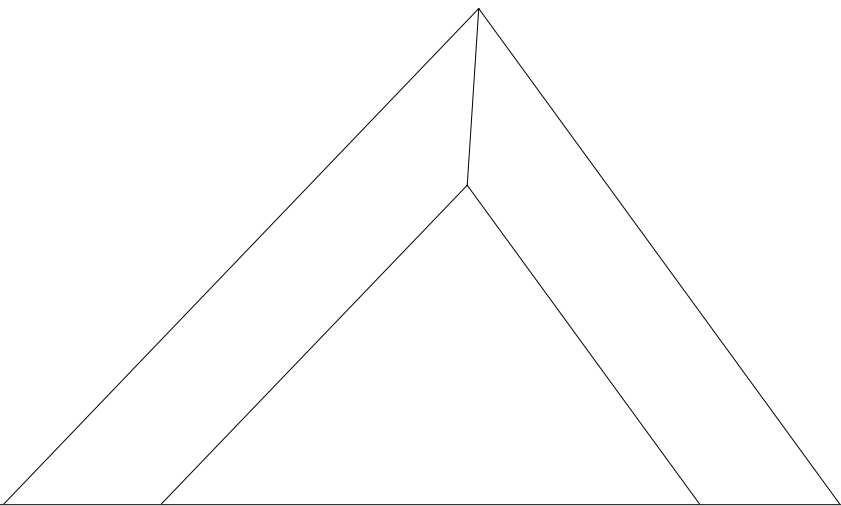

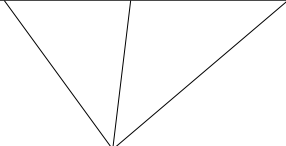

9-6

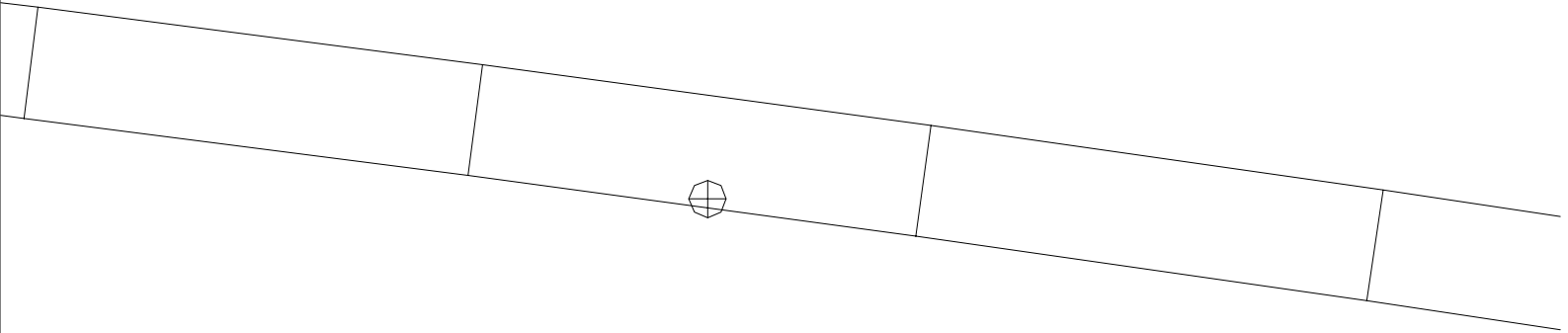



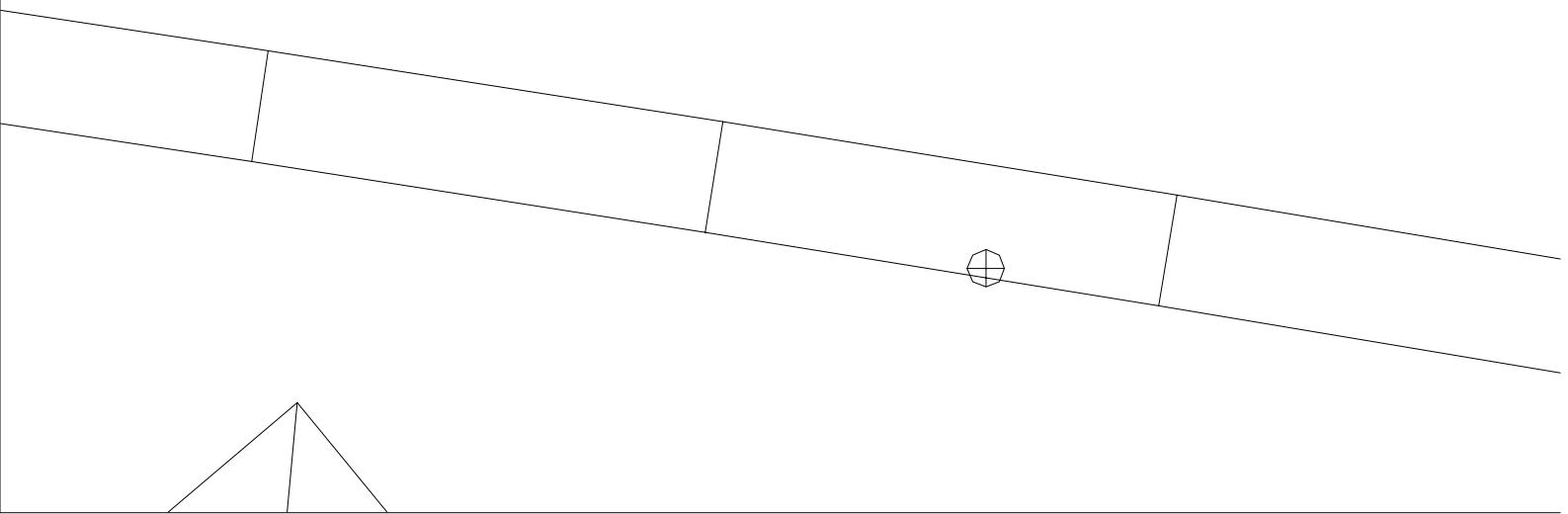

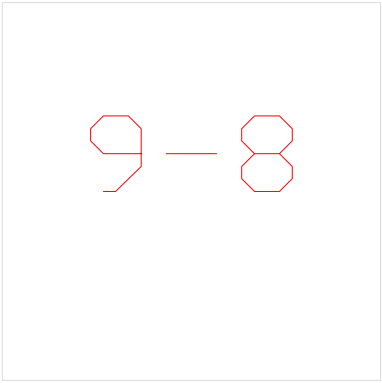





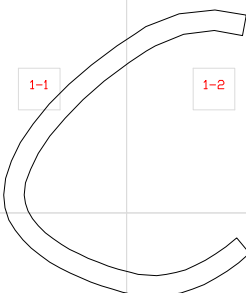

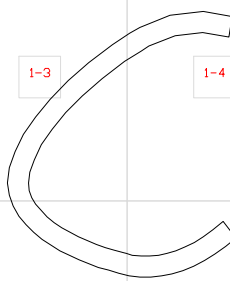

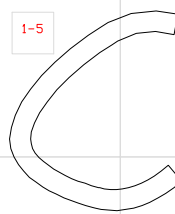

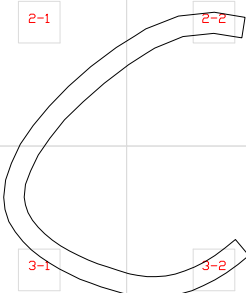

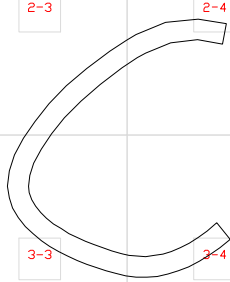

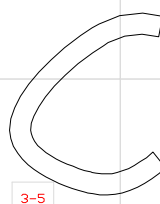

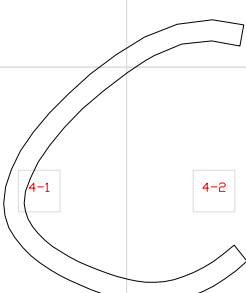

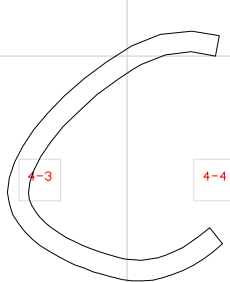

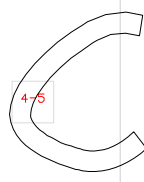

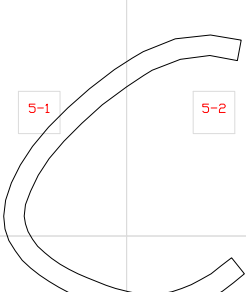

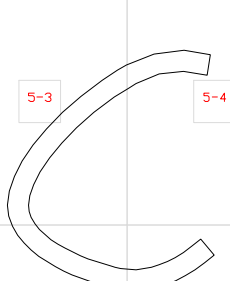

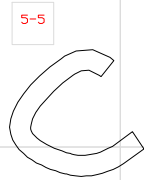

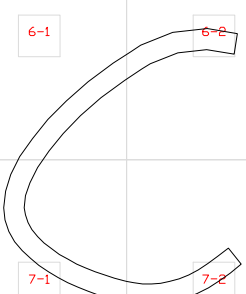

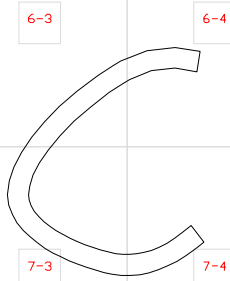

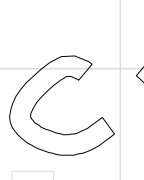

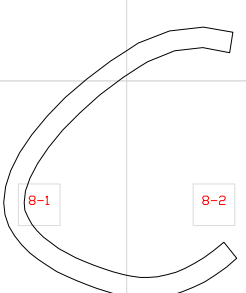

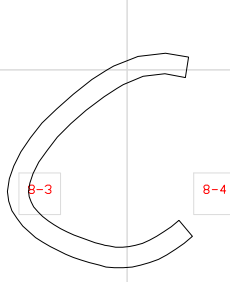











$$9 - 7$$





9-8

9-9

 1-1	 1-2	 1-3	 1-4	 1-5	 1-6
 2-1	 2-2	 2-3	 2-4	 2-5	 2-6
 3-1	 3-2	 3-3	 3-4	 3-5	 3-6
 4-1	 4-2	 4-3	 4-4	 4-5	 4-6
 5-1	 5-2	 5-3	 5-4	 5-5	 5-6
 6-1	 6-2	 6-3	 6-4	 6-5	 6-6
 7-1	 7-2	 7-3	 7-4	 7-5	 7-6
 8-1	 8-2	 8-3	 8-4	 8-5	 8-6
 9-1	 9-2	 9-3	 9-4	 9-5	 9-6

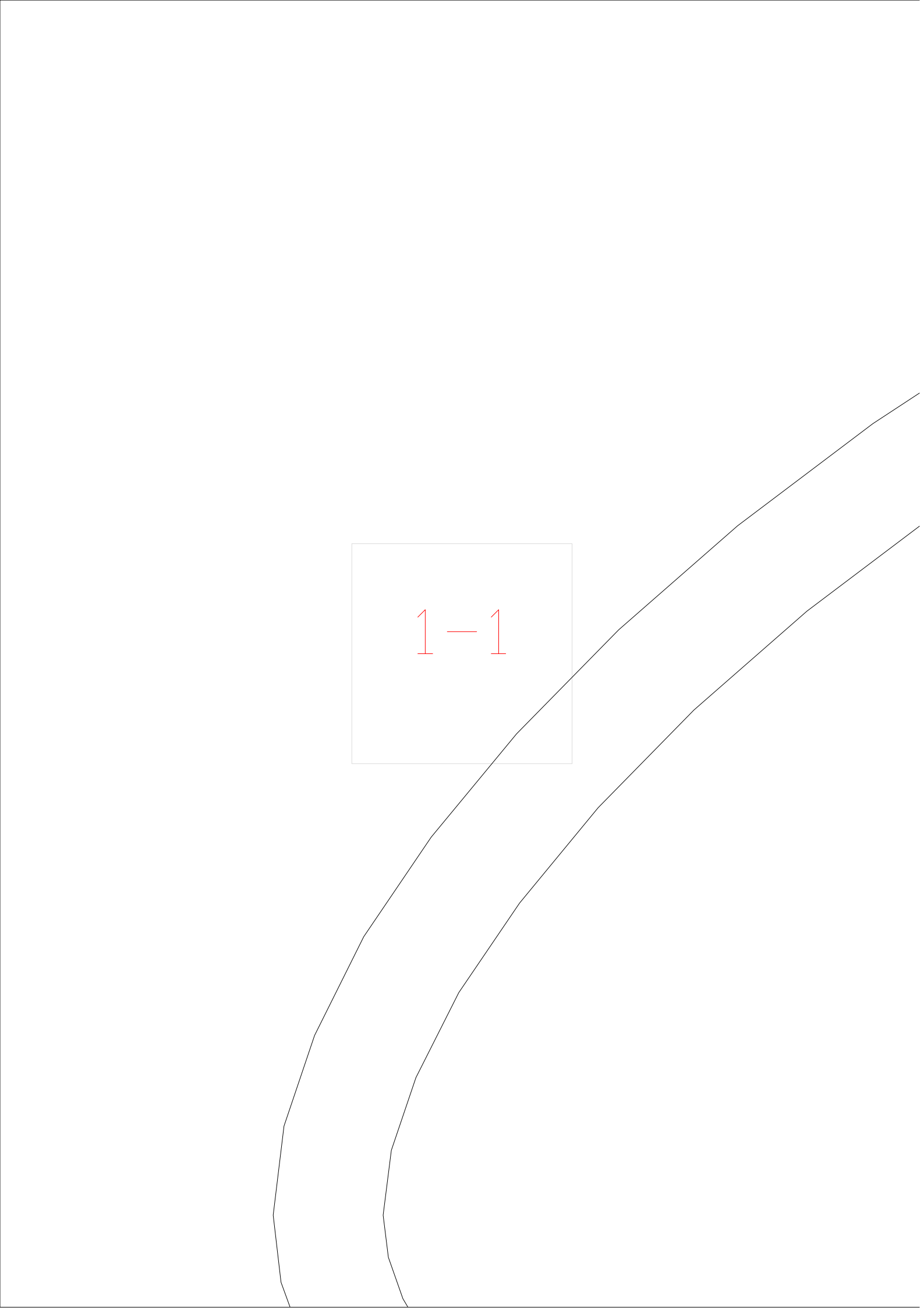

1-1

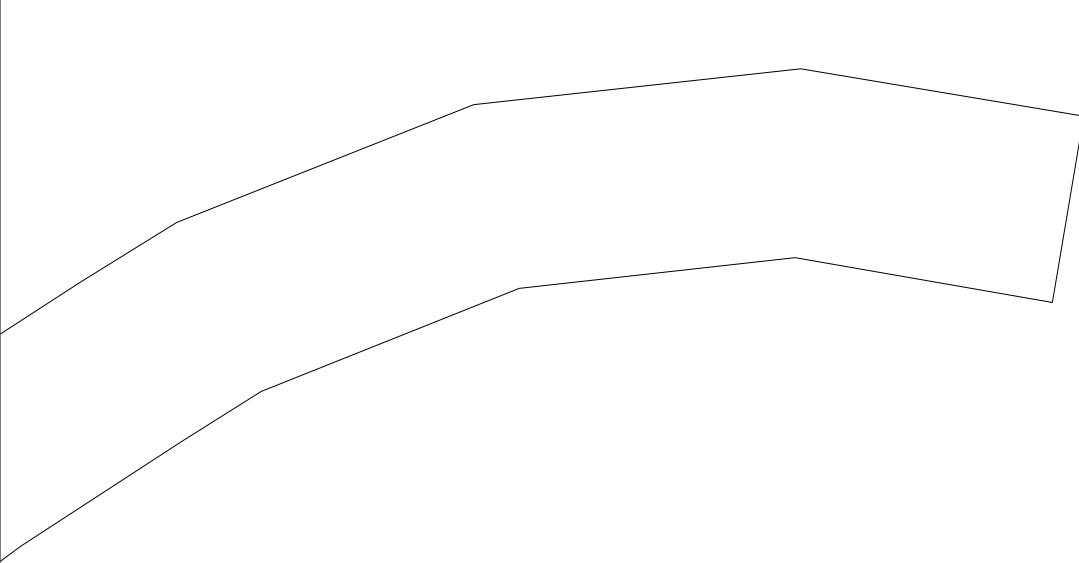

1-2



1-3

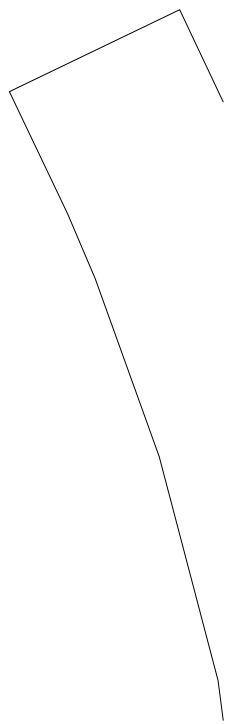

1-4



1-5

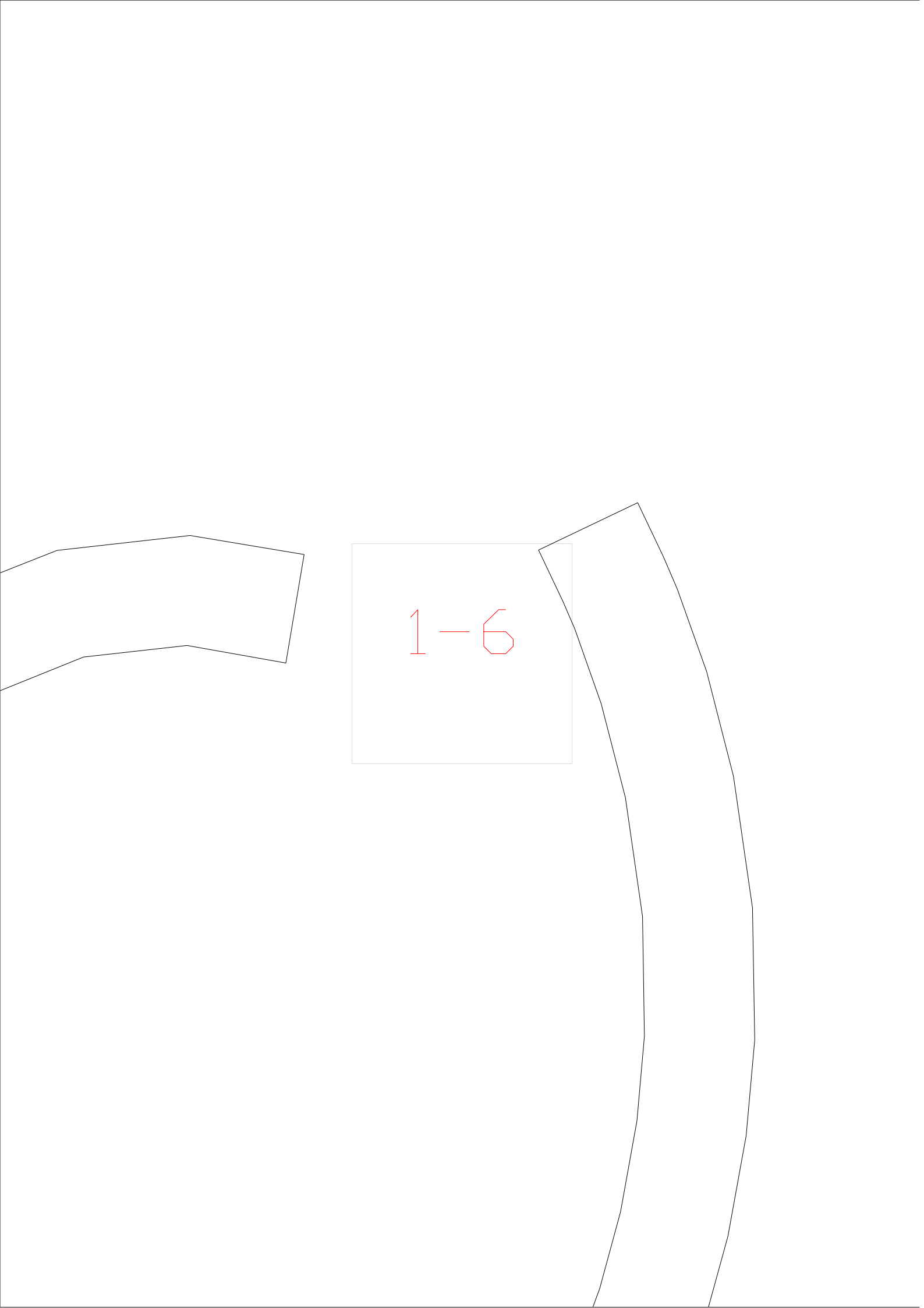

1-6



2-1

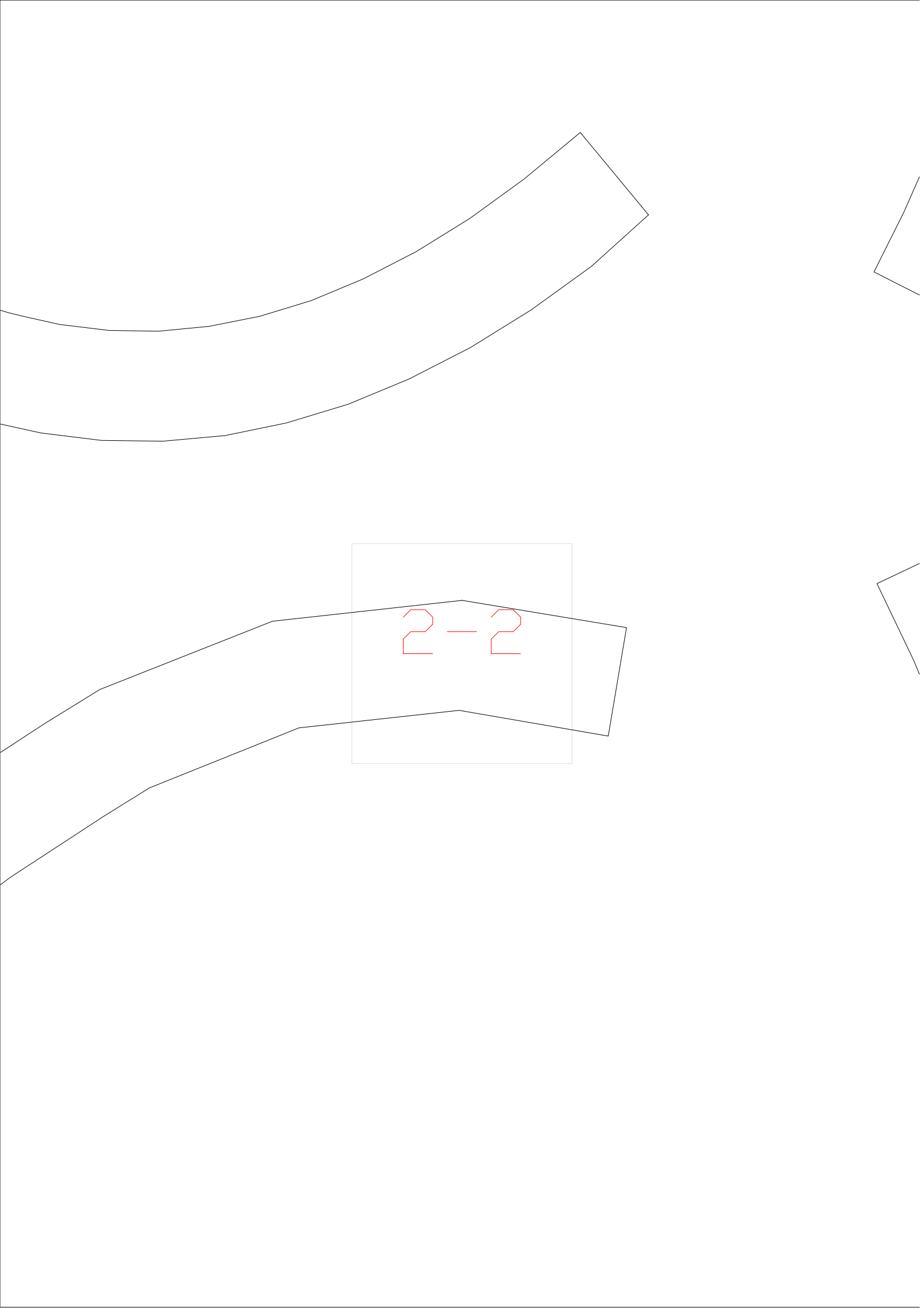

2-2



2-3



2-4



2-5

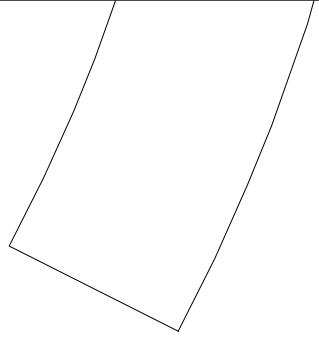
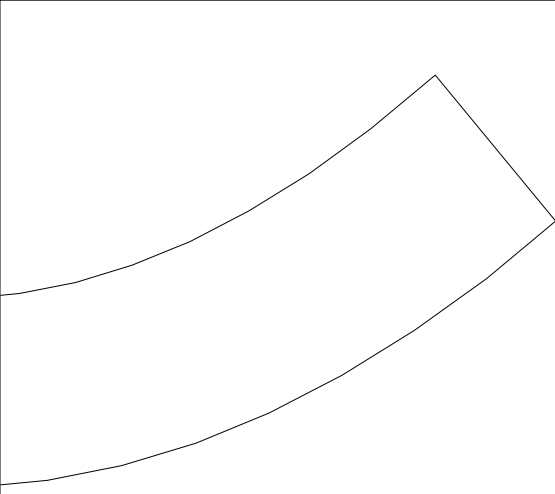

2-6

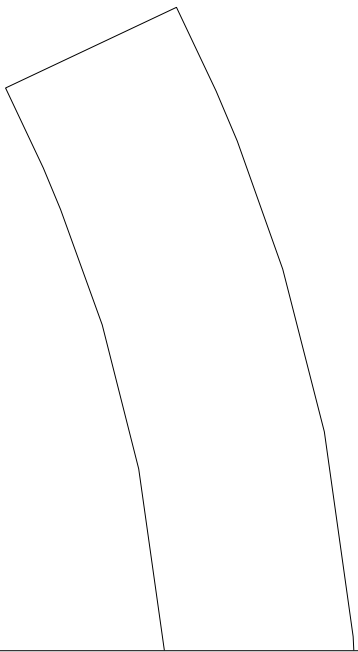
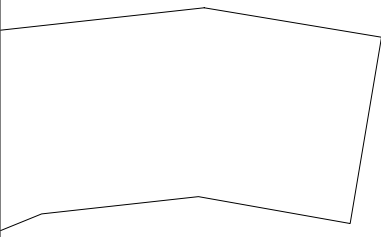

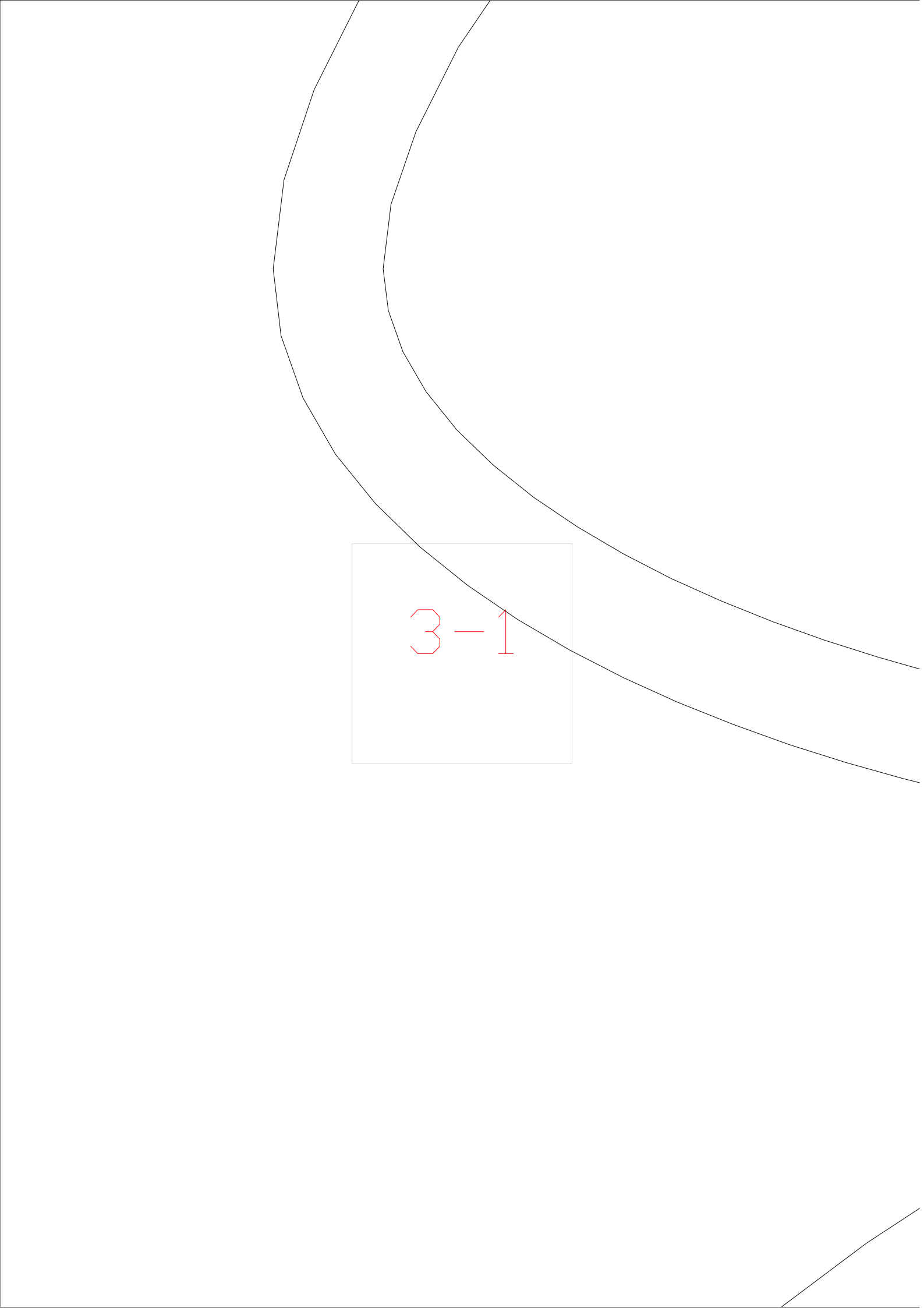

3-1



3-2

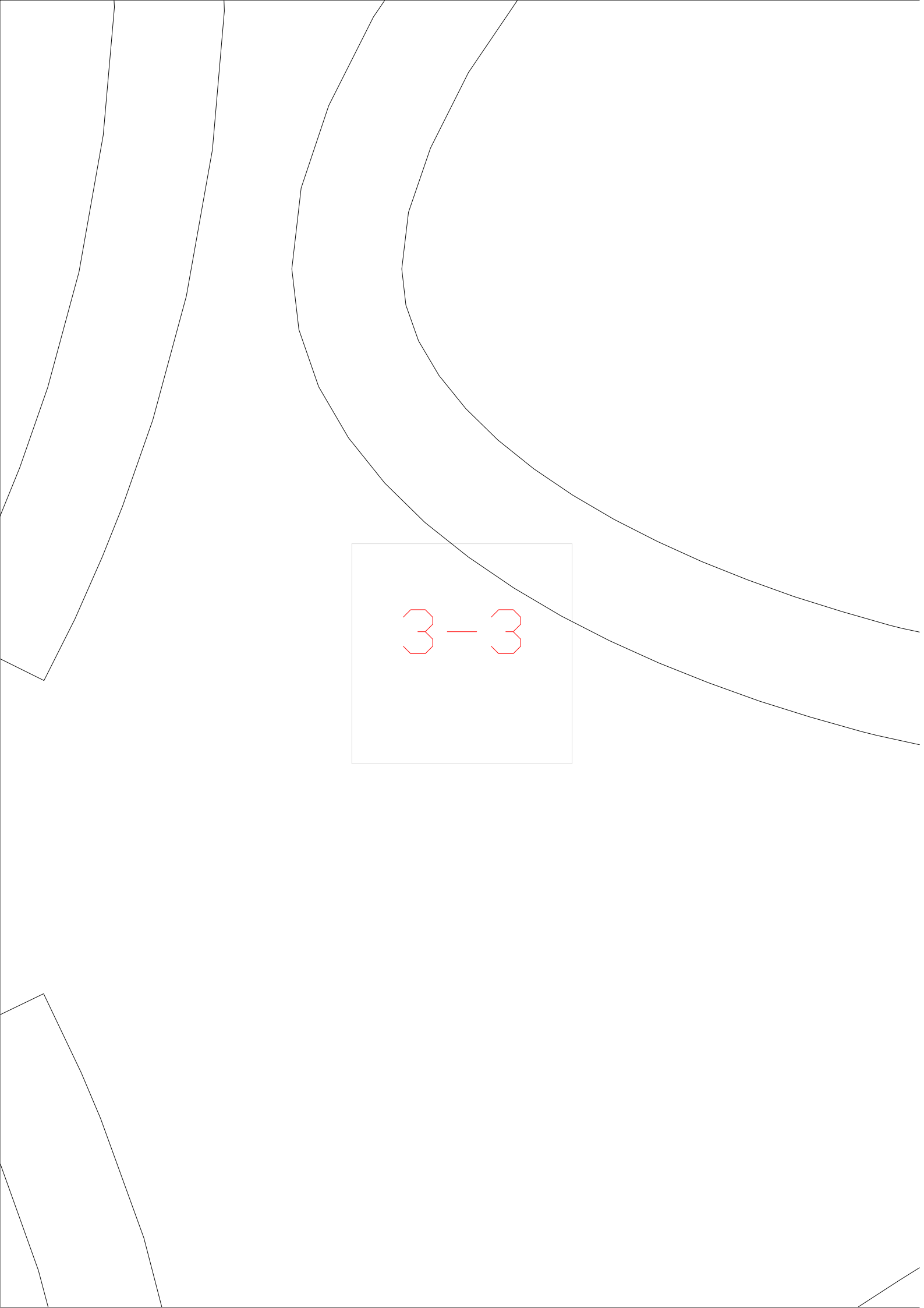

3-3

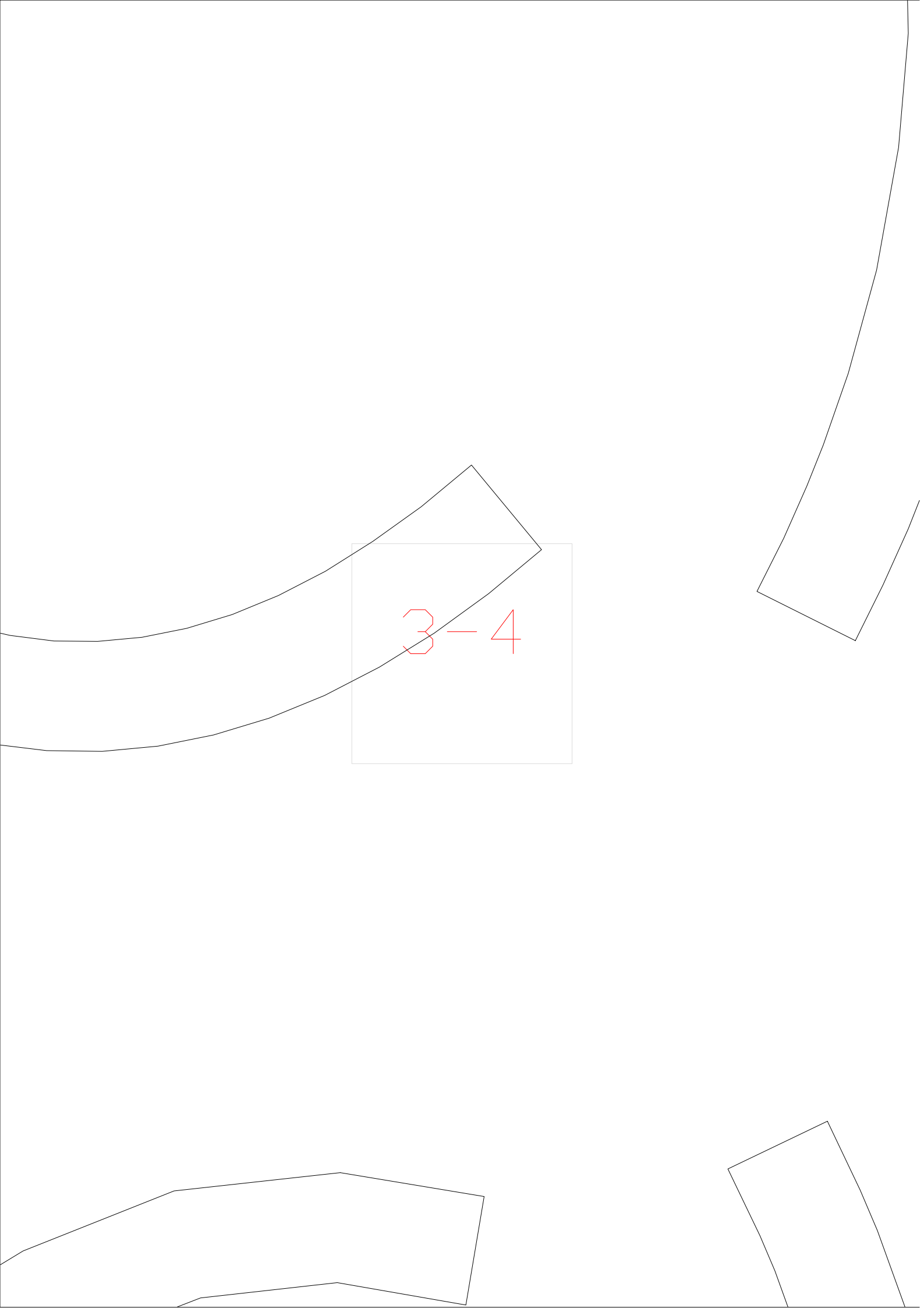

3-4



3-5

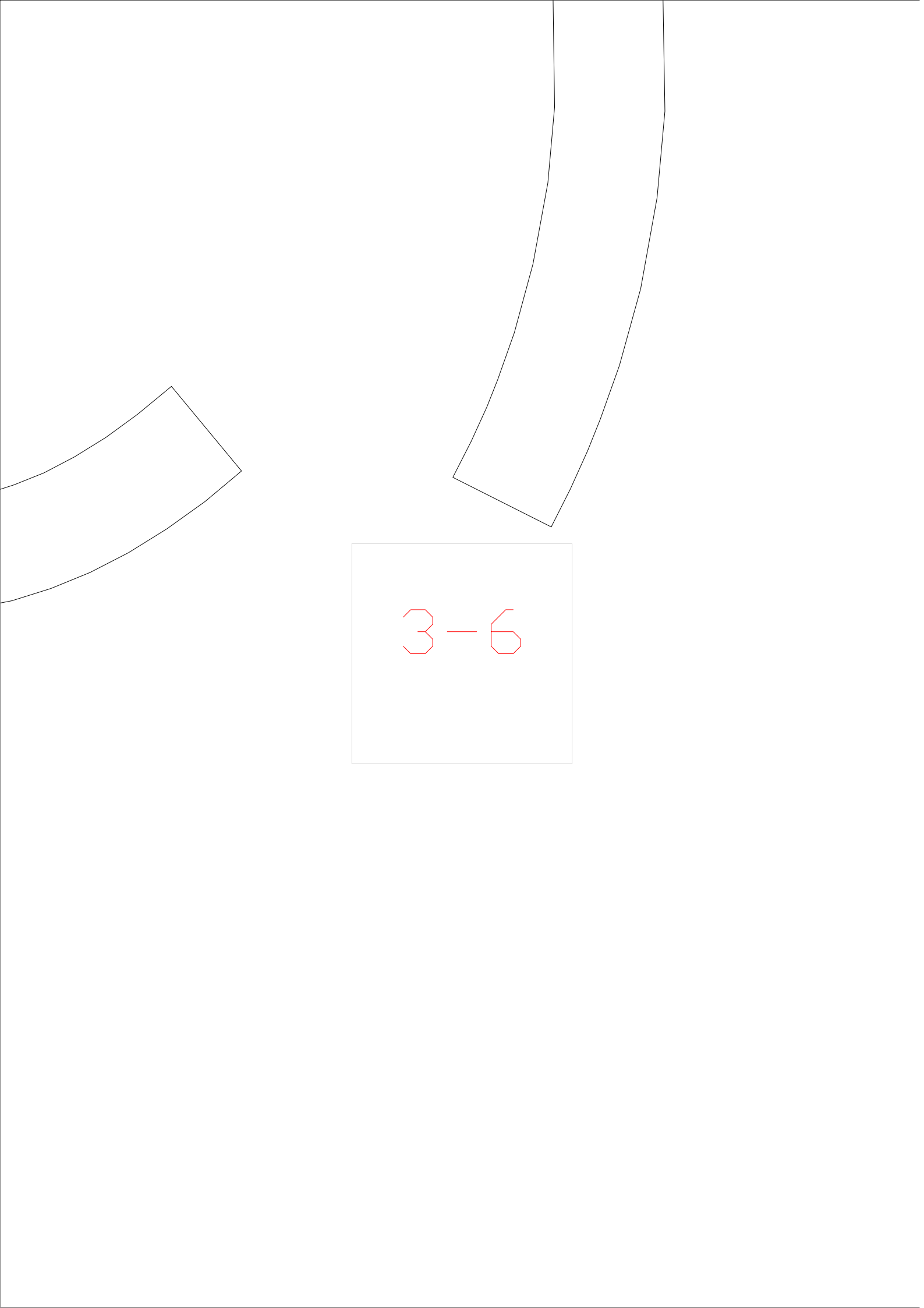

3-6

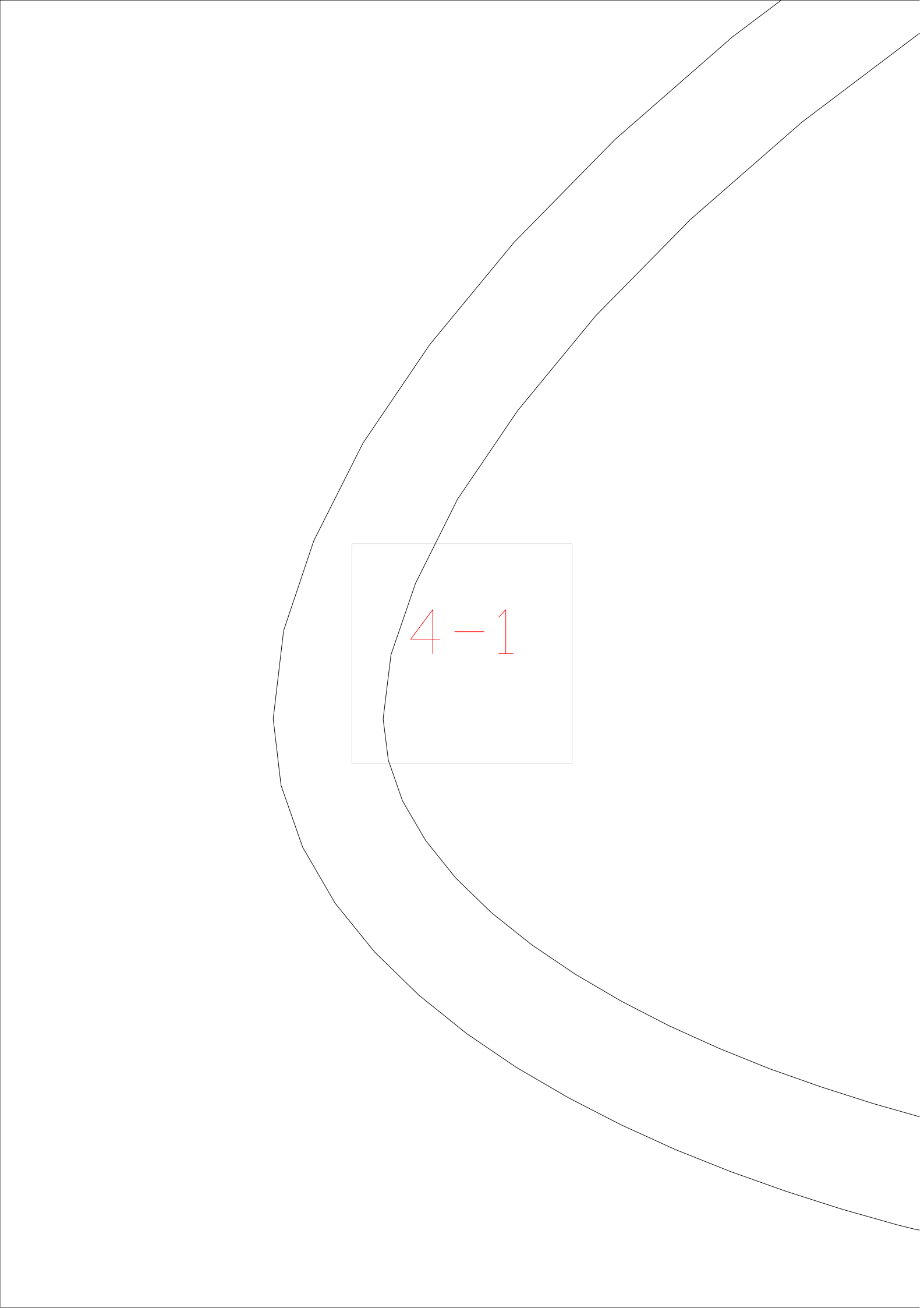

4 - 1

$$4 - 2$$



4-3

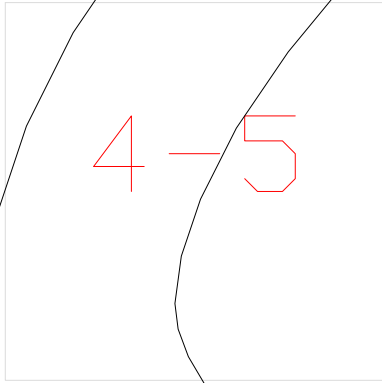

$$4 - 4$$

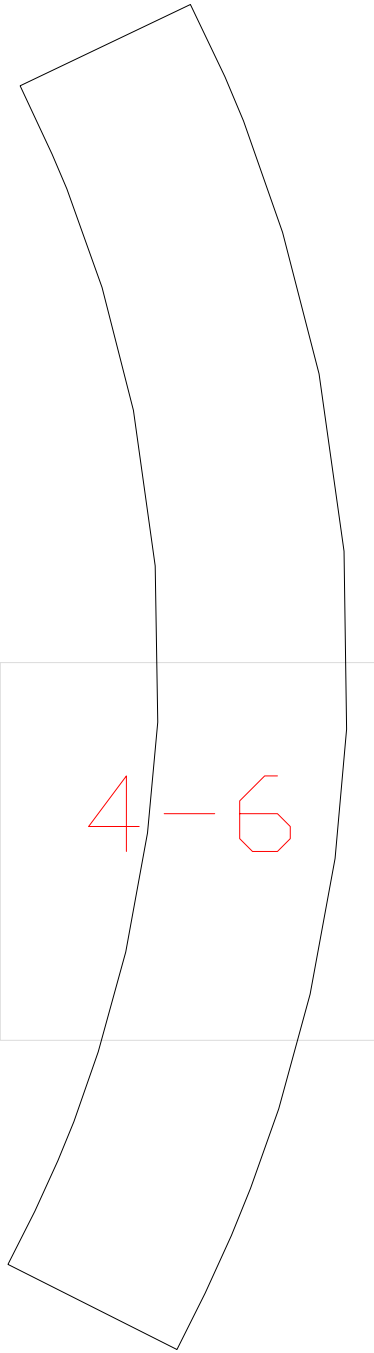
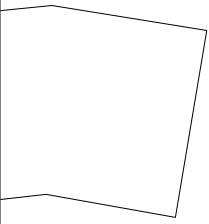

4-5

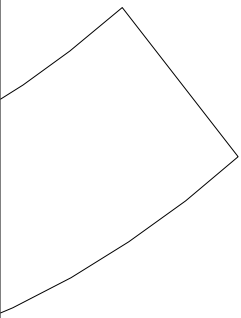

4-6



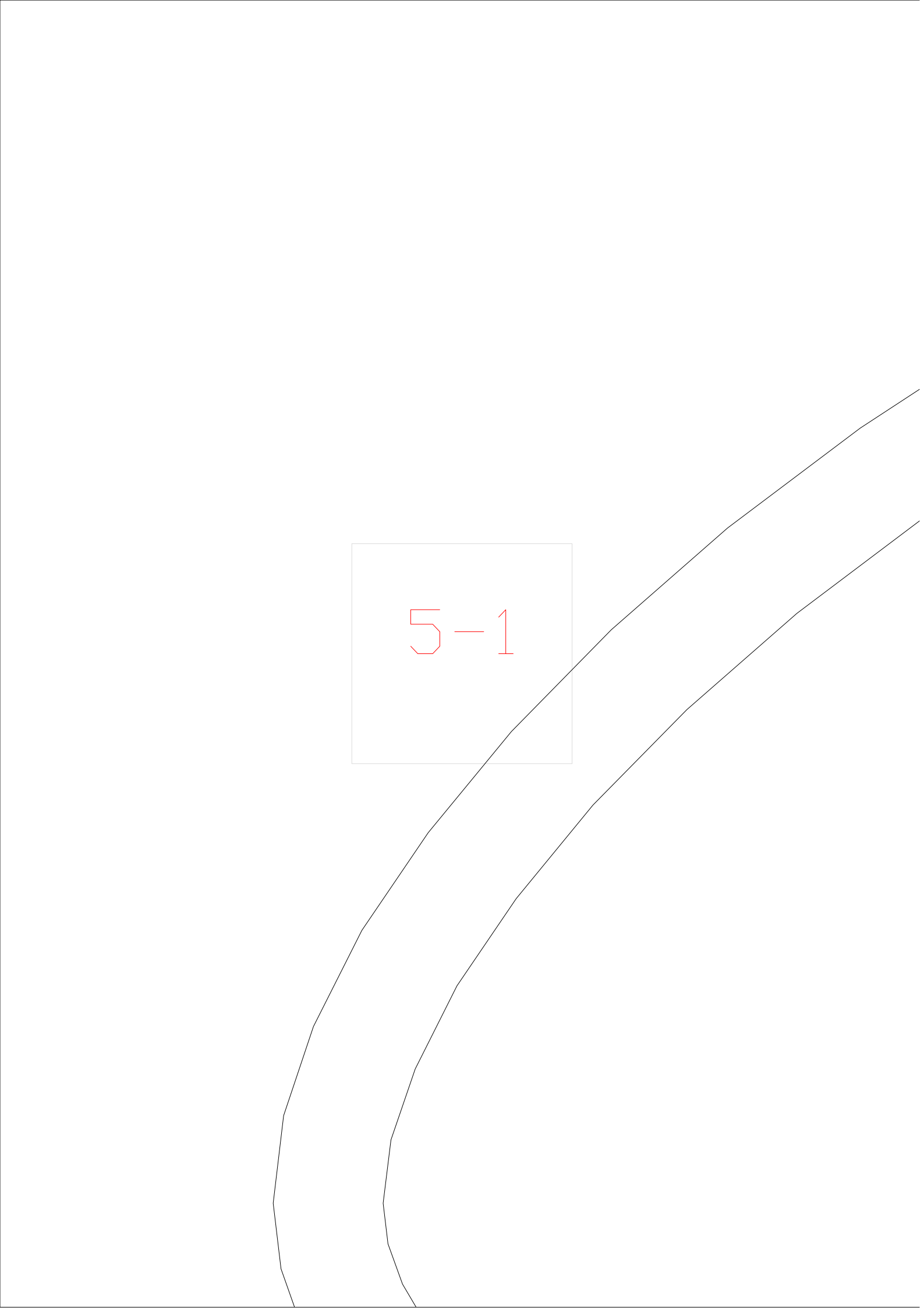

5-1

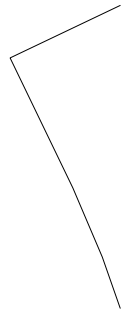
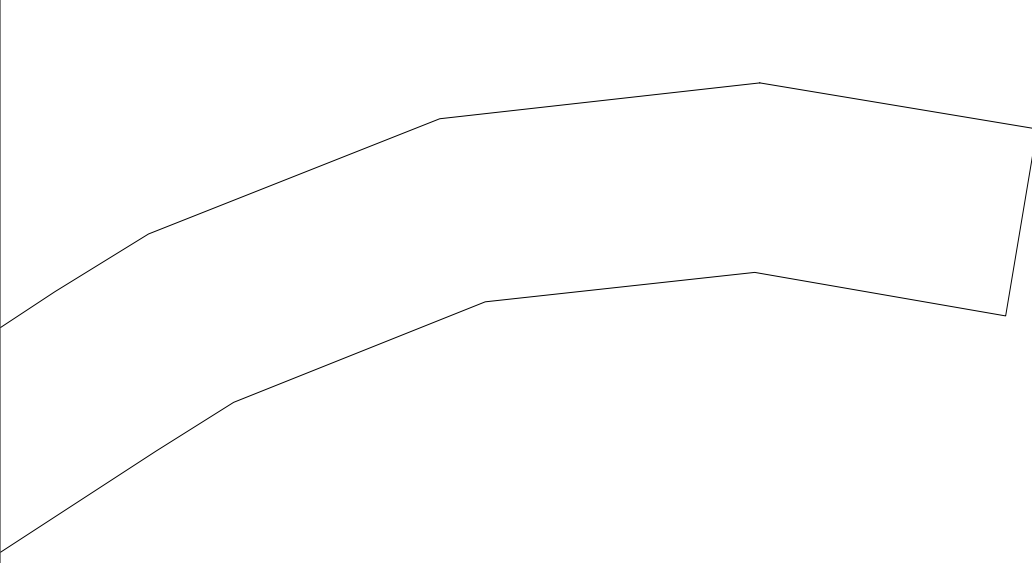

5-2



5-3

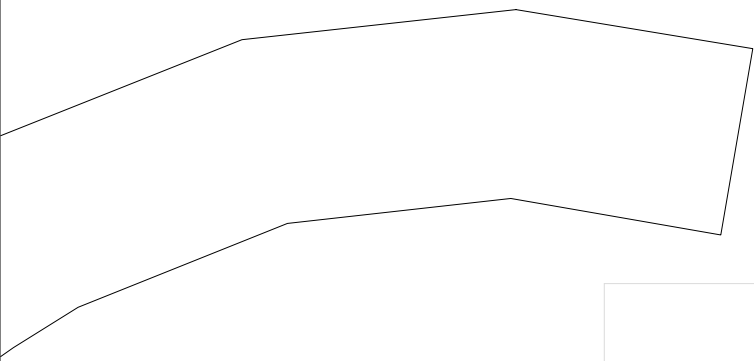

5-4

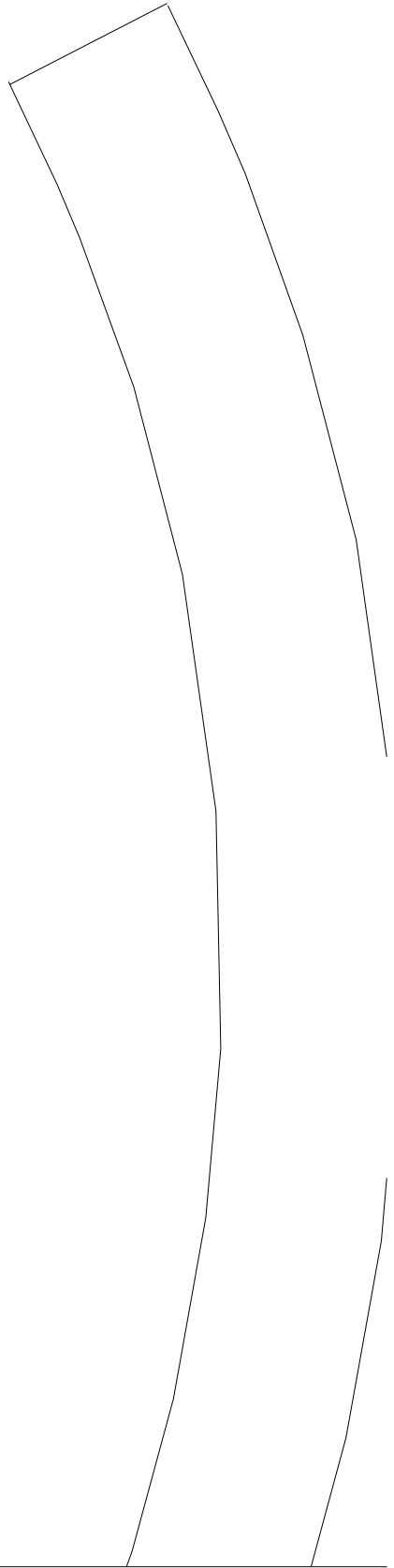

5-5

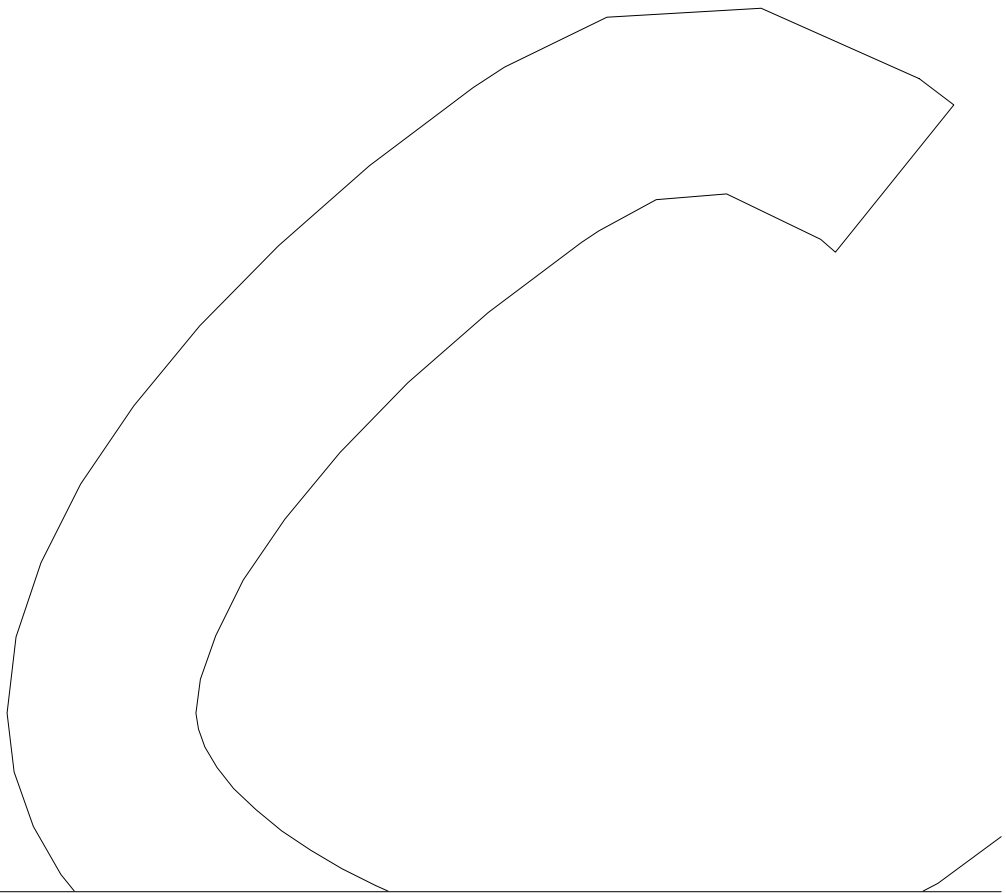

5-6



6-1

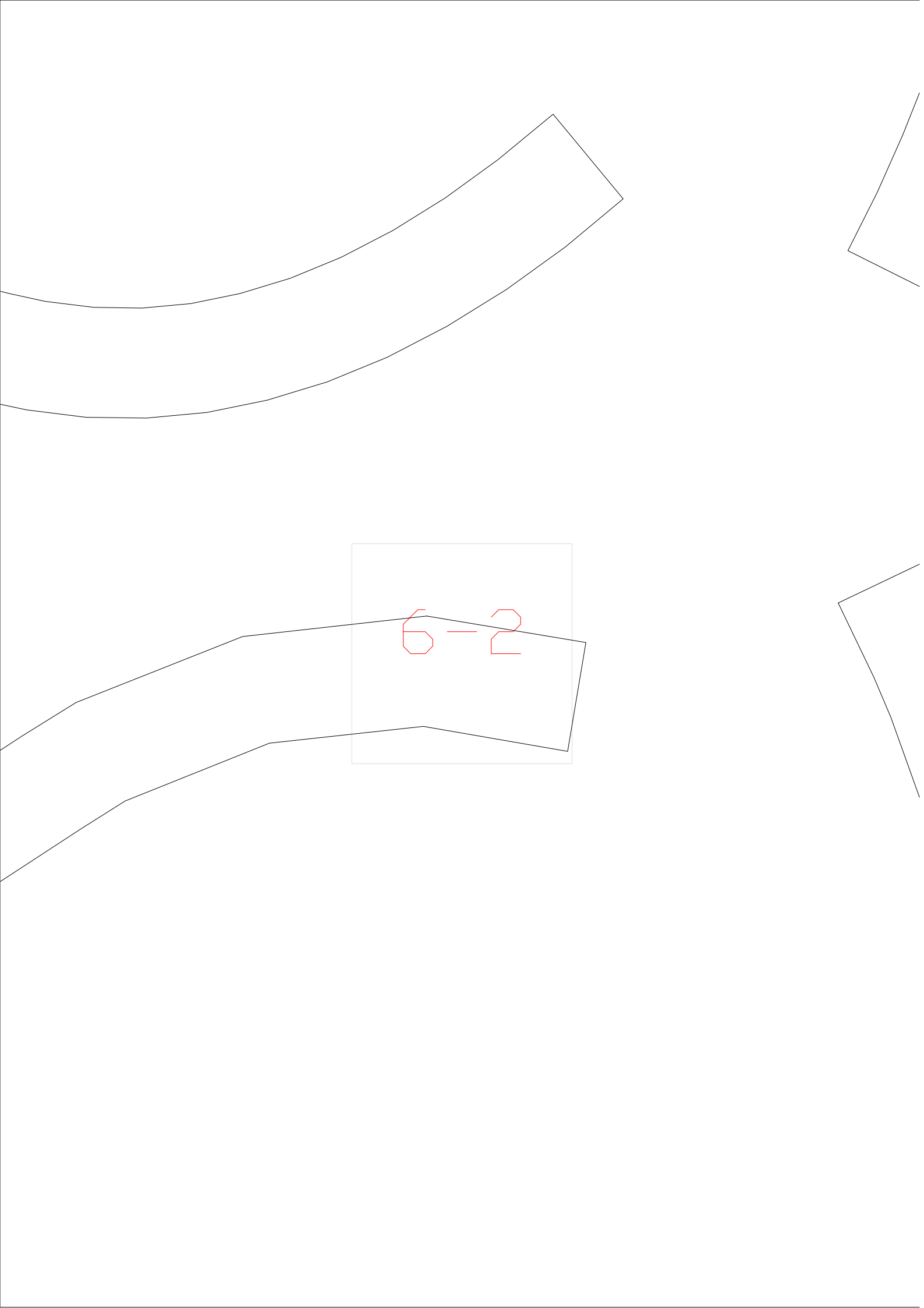

6-2



6-3

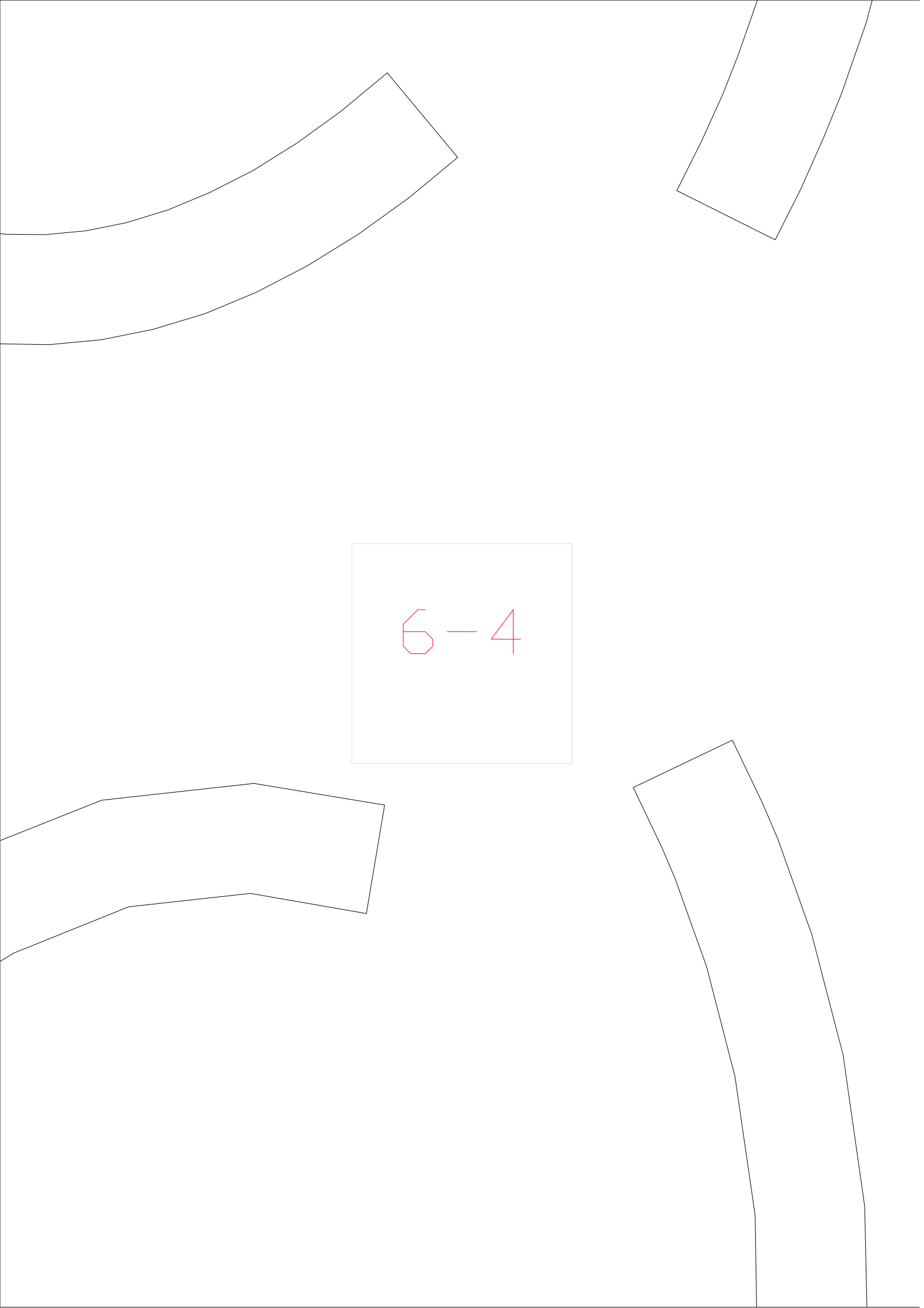

6-4

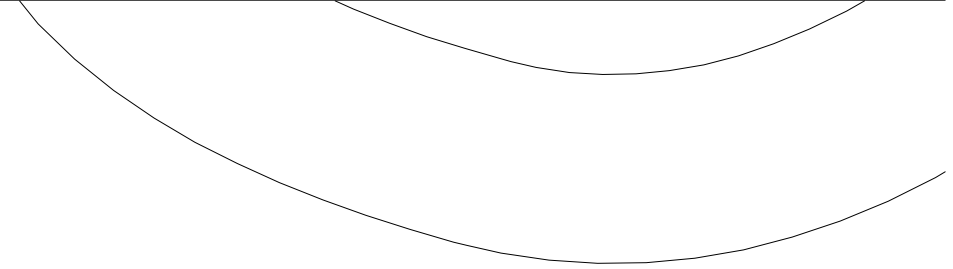

6-5

6-6

$$7 - 1$$

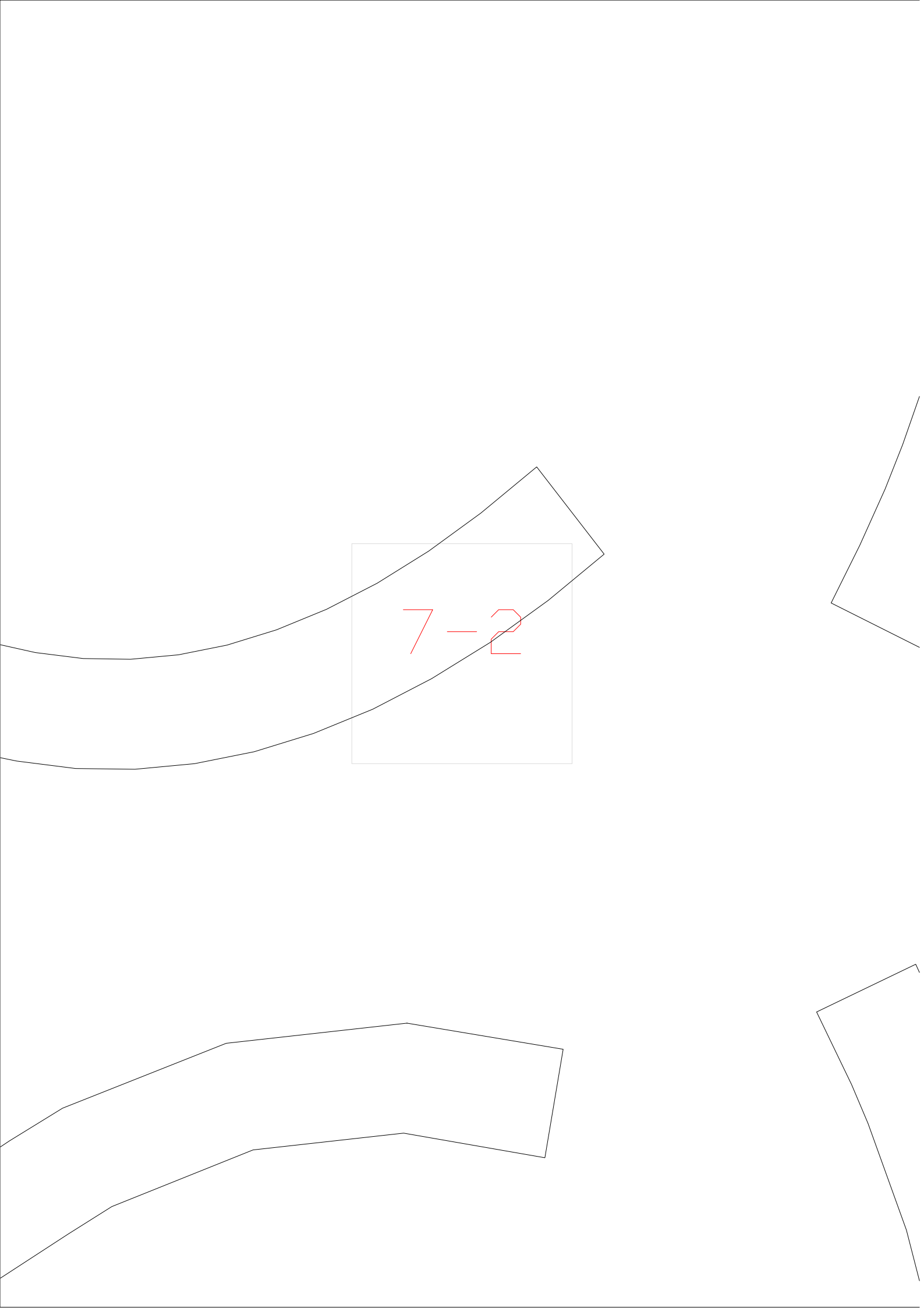

7-2



$$7 - 3$$

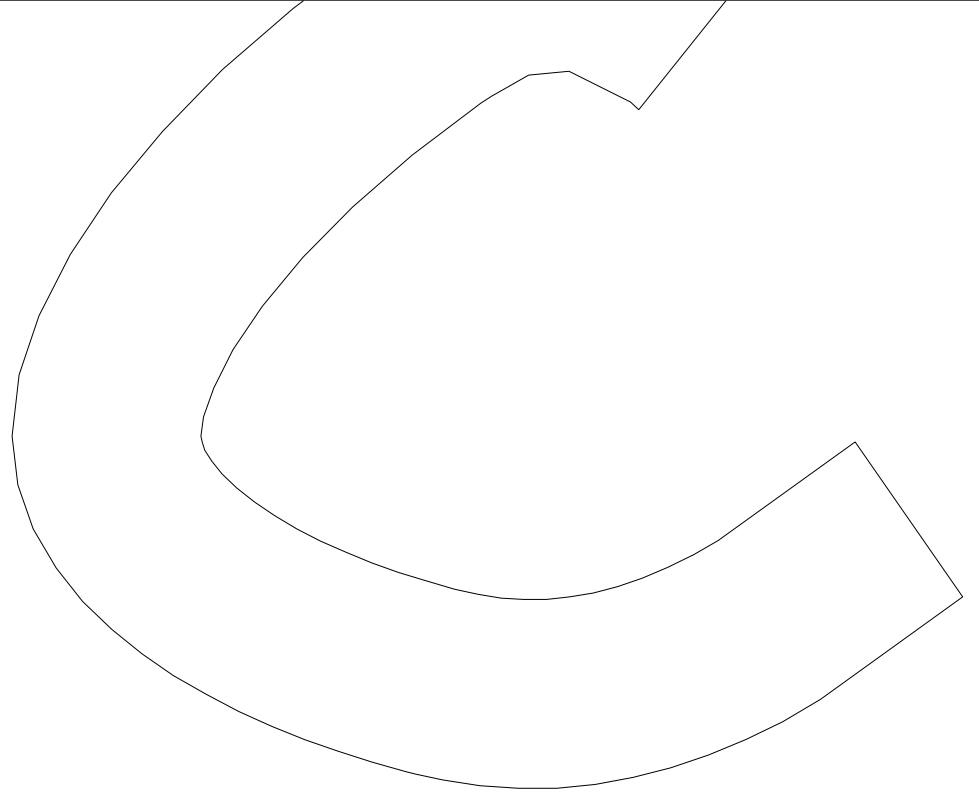

7 - 4

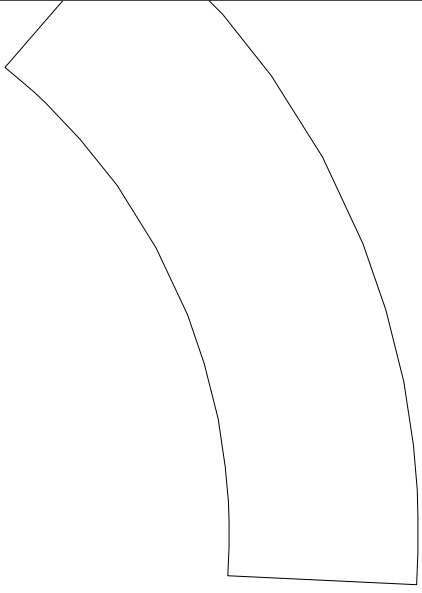

$$7 - 5$$



$$7-6$$



8-1

8-2

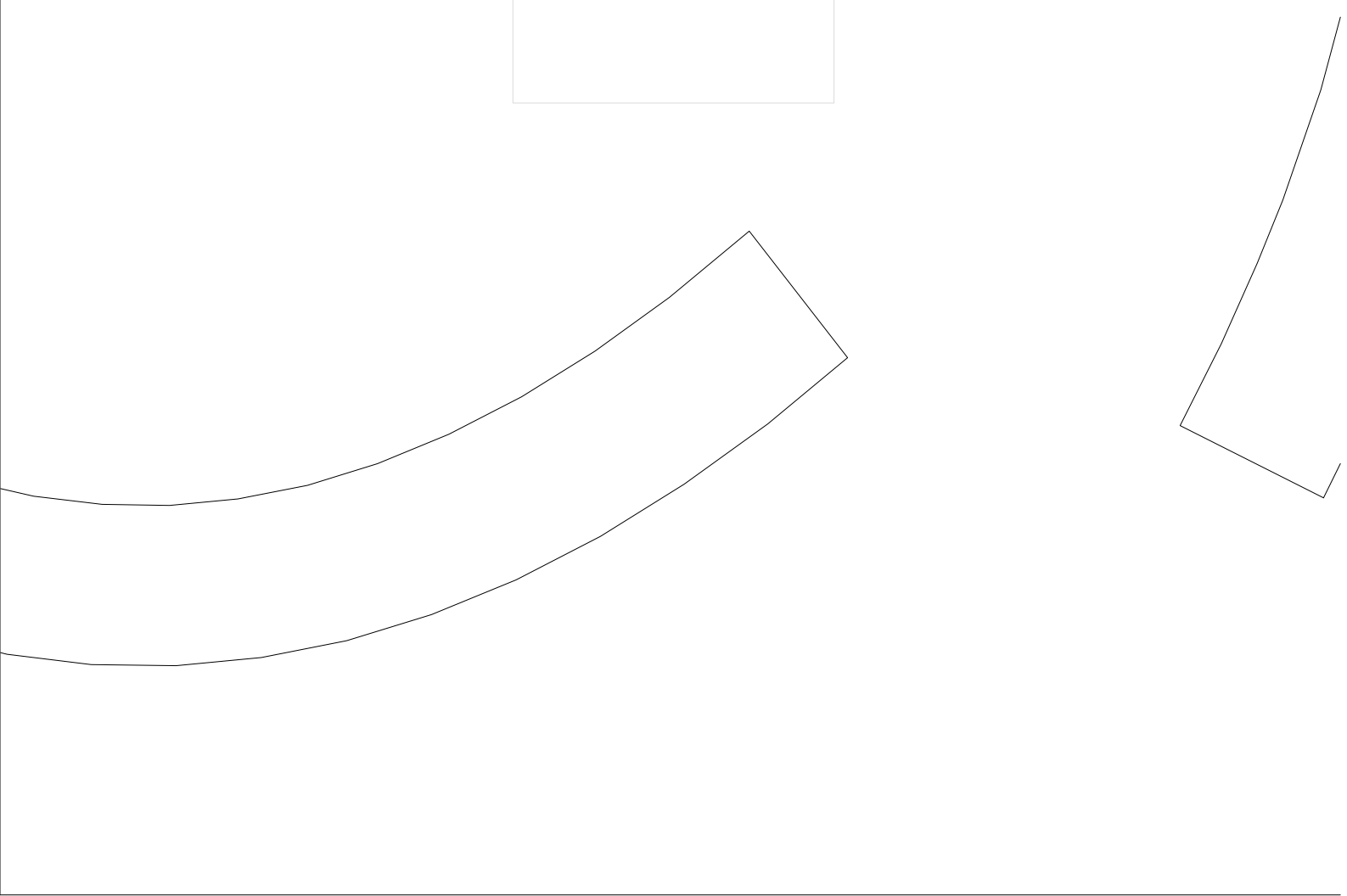

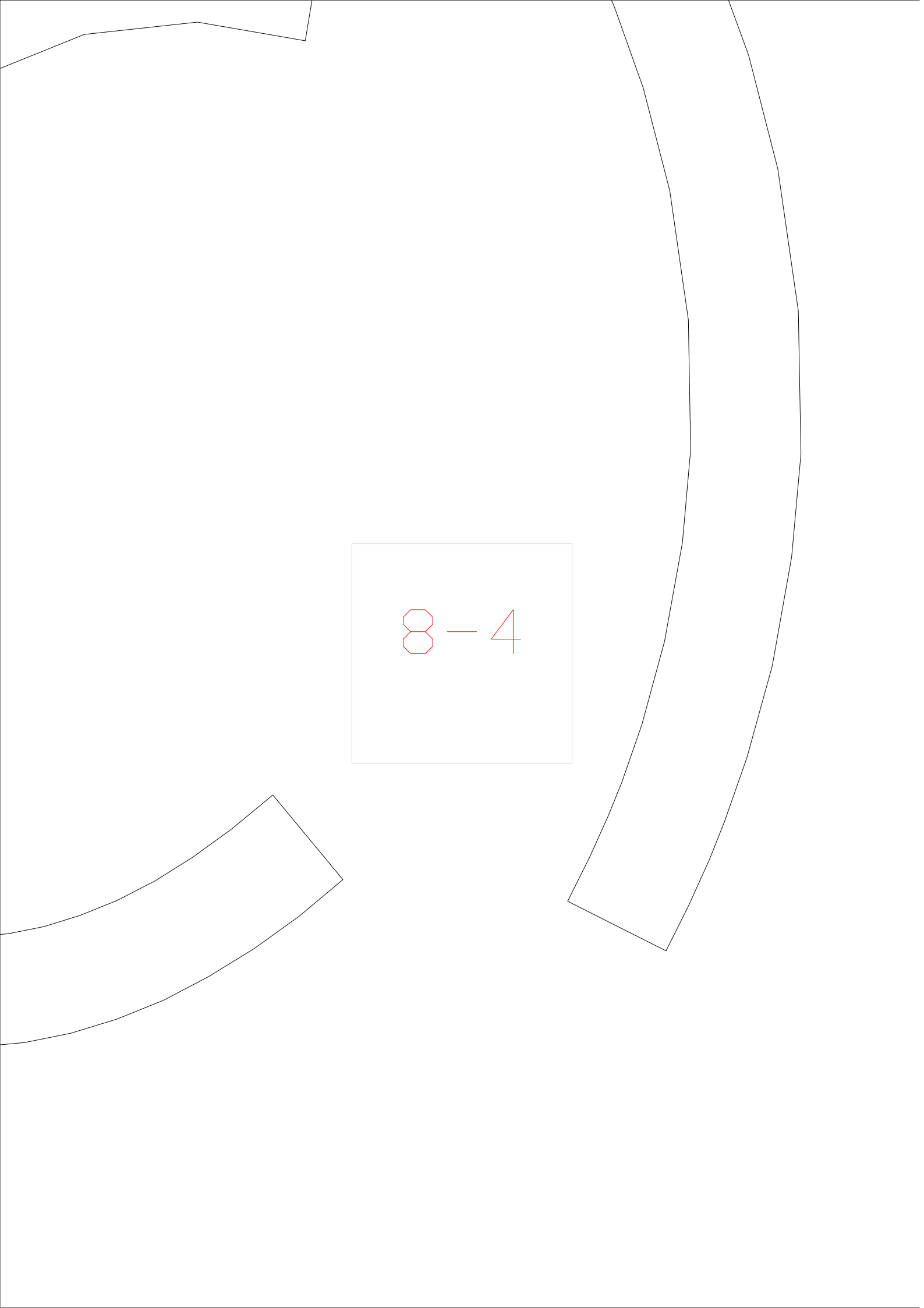

8-3

$$8 - 4$$

$$8 - 5$$

8-6

9-2

9-3

$$9 - 4$$

9-5

9-6